



US00D710215S

(12) **United States Design Patent**
Palmer et al.

(10) **Patent No.:** **US D710,215 S**

(45) **Date of Patent:** **** Aug. 5, 2014**

(54) **PACKAGING FOR SANITATION GLOVES**

(71) Applicant: **Medline Industries, Inc.**, Mundelein, IL (US)

(72) Inventors: **Brian Palmer**, Highwood, IL (US);
Emily Somers, Cary, IL (US)

(73) Assignee: **Medline Industries, Inc.**, Mundelein, IL (US)

(**) Term: **14 Years**

(21) Appl. No.: **29/456,102**

(22) Filed: **May 28, 2013**

Related U.S. Application Data

(63) Continuation of application No. 29/417,572, filed on Apr. 5, 2012, now Pat. No. Des. 683,245.

(51) **LOC (10) Cl.** **09-01**

(52) **U.S. Cl.**
USPC **D9/734**

(58) **Field of Classification Search**

USPC D9/414, 416, 418, 421, 423, 426, 432, D9/433, 436, 443, 447, 500, 502, 503, 516, D9/517, 519, 529, 531; 206/233, 390, 409, 206/444, 494, 503, 504, 509, 812, 823, 206/824; 221/26, 33, 45, 48, 63; D6/515-523; D3/203.1, 203.5, 203.6; 229/238, 242, 915

See application file for complete search history.

(56) **References Cited**

U.S. PATENT DOCUMENTS

1,716,628 A * 6/1929 Gittleman 221/63
2,287,420 A * 6/1942 Edmonston 221/63
D171,955 S * 4/1954 Robins D9/721
3,145,840 A * 8/1964 Wright 206/494
3,239,097 A * 3/1966 Bates et al. 221/48

3,243,079 A * 3/1966 Rettmer 221/63
3,372,837 A * 3/1968 Neumann 221/34
3,424,367 A * 1/1969 Lesinski et al. 229/118
3,635,393 A * 1/1972 Herglotz 229/125.15
4,200,200 A * 4/1980 Hein et al. 221/48

(Continued)

Primary Examiner — Derrick Holland

Assistant Examiner — Lauren Calve

(74) *Attorney, Agent, or Firm* — McAndrews, Held & Malloy, Ltd.

(57) **CLAIM**

The ornamental design for packaging for sanitation gloves, as shown and described.

DESCRIPTION

FIG. 1 is a front perspective view of packaging for sanitation gloves showing a first embodiment of my new design; FIG. 2 is a front perspective view thereof with the unclaimed hand and glove depictions removed; FIG. 3 is a front elevation view thereof; FIG. 4 is a rear elevation view thereof; FIG. 5 is a right side elevation view thereof; FIG. 6 is a left side elevation view thereof; FIG. 7 is a top plan view thereof; FIG. 8 is a bottom plan view thereof; FIG. 9 is a front perspective view of packaging for sanitation gloves showing a second embodiment of my new design; FIG. 10 is a front elevation view thereof; FIG. 11 is a rear elevation view thereof; FIG. 12 is a right side elevation view thereof; FIG. 13 is a left side elevation view thereof; FIG. 14 is a top plan view thereof; and, FIG. 15 is a bottom plan view thereof.

The dotted lines shown in FIGS. 9 and 14 represent claimed perforations. The broken lines shown in FIGS. 1, 2, 7, 9 and 14 represent unclaimed subject and form no part of the claimed design. The surface stippling represents a contrast of color relative to the non-stippled areas.

1 Claim, 9 Drawing Sheets

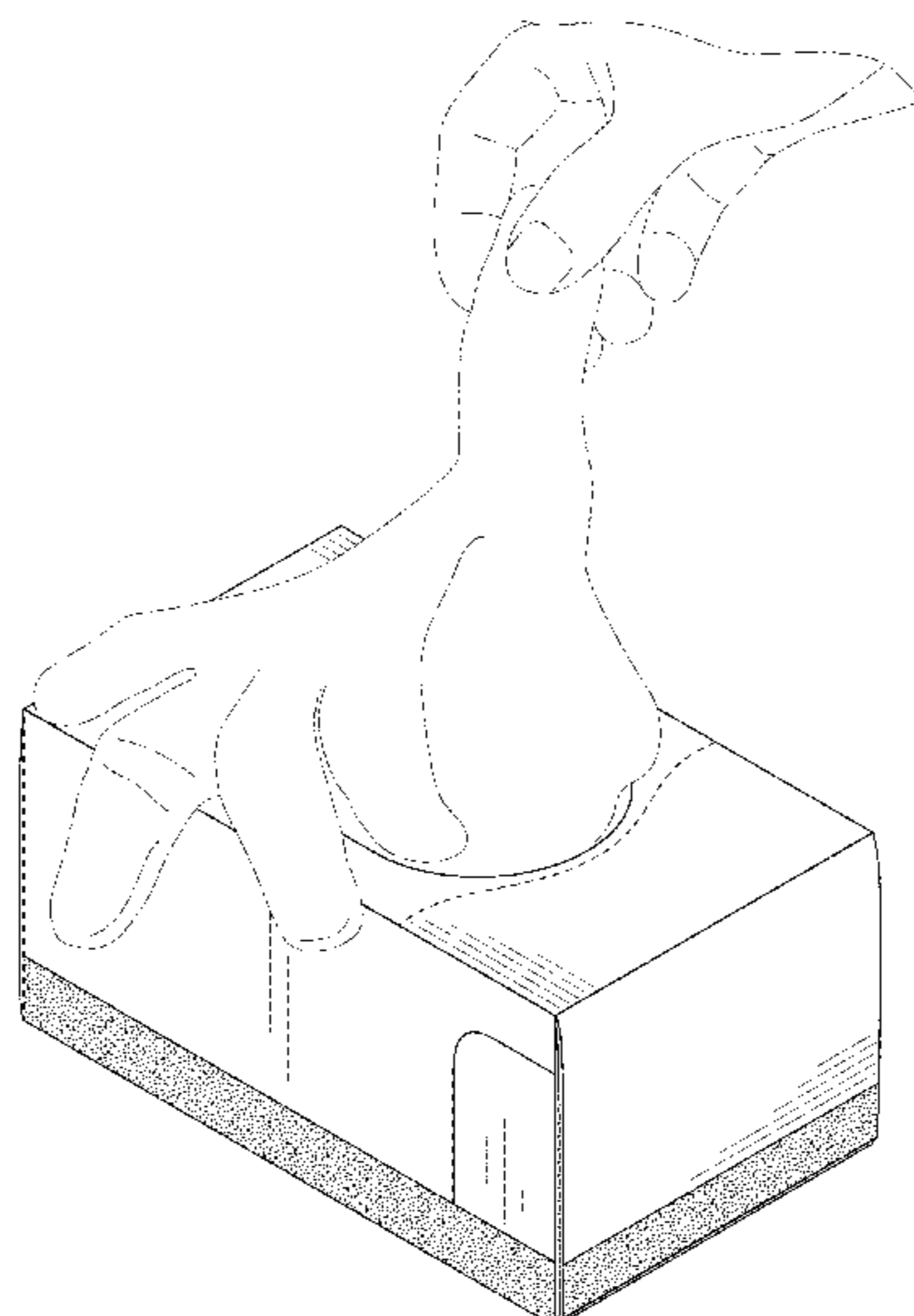

(56)

References Cited

U.S. PATENT DOCUMENTS

4,997,105	A *	3/1991	Fischer	221/45	7,063,233	B2 *	6/2006	Jordan et al.	221/197
D328,992	S	9/1992	Hollinger		D568,763	S *	5/2008	Keberlein	D9/734
D353,091	S *	12/1994	Mumford	D9/761	7,565,976	B2	7/2009	Nakamura et al.	
5,379,897	A *	1/1995	Muckenfuhs et al.	206/494	D608,660	S	1/2010	Mau	
5,542,598	A	8/1996	Capo		7,661,554	B2 *	2/2010	Szymonski et al.	221/50
5,556,026	A	9/1996	Blankitny		2002/0175094	A1	11/2002	Campbell et al.	
5,816,440	A *	10/1998	Shields et al.	221/45	2005/0011906	A1 *	1/2005	Buck et al.	221/64
D504,314	S *	4/2005	Kim	D9/416	2005/0150788	A1 *	7/2005	Feusner	206/278
D514,437	S *	2/2006	Kim	D9/416	2009/0261001	A1	10/2009	Yao et al.	
					2010/0270325	A1 *	10/2010	Fearon	221/45
					2011/0215110	A1 *	9/2011	Kadhun et al.	221/45

* cited by examiner

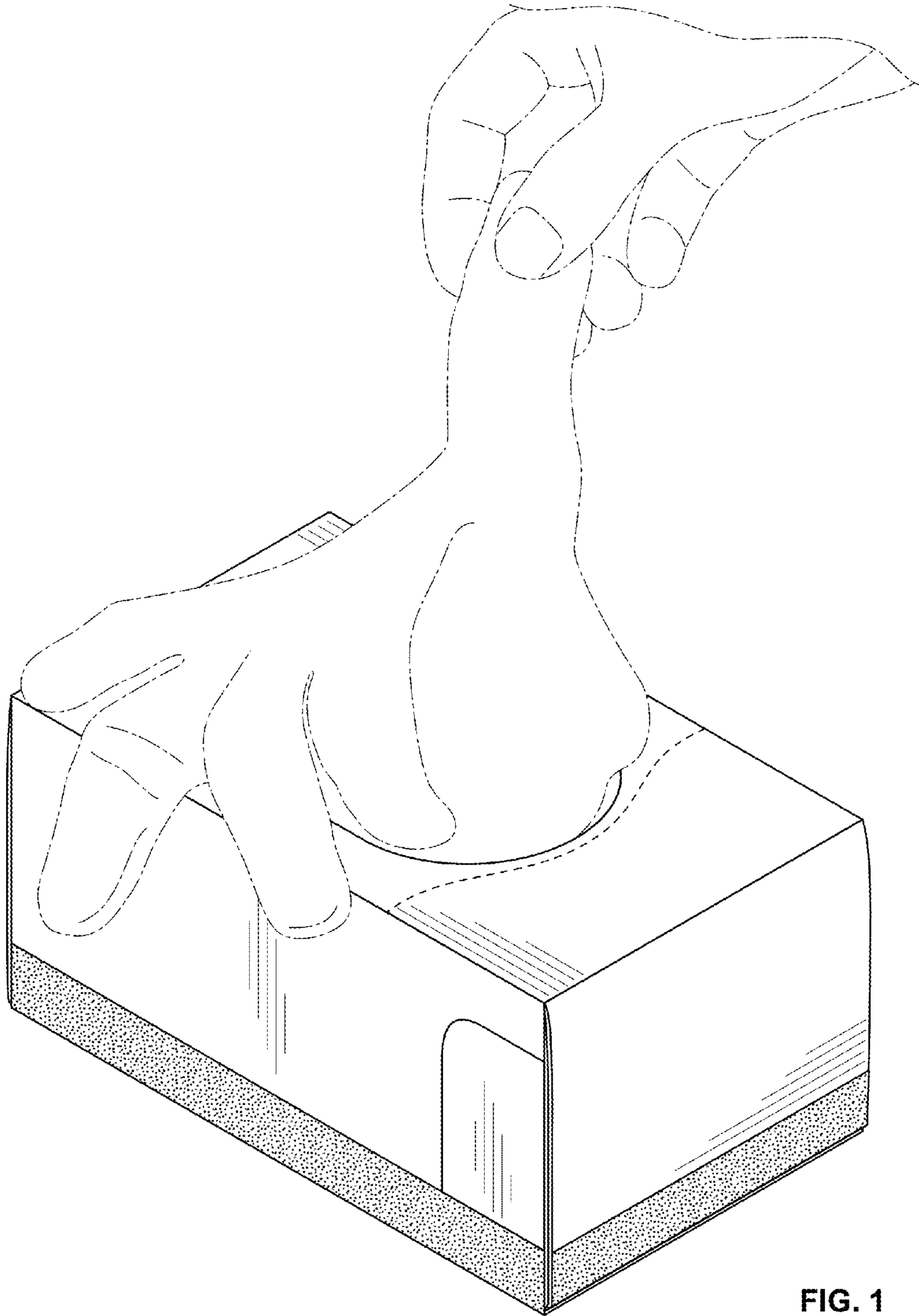

FIG. 1

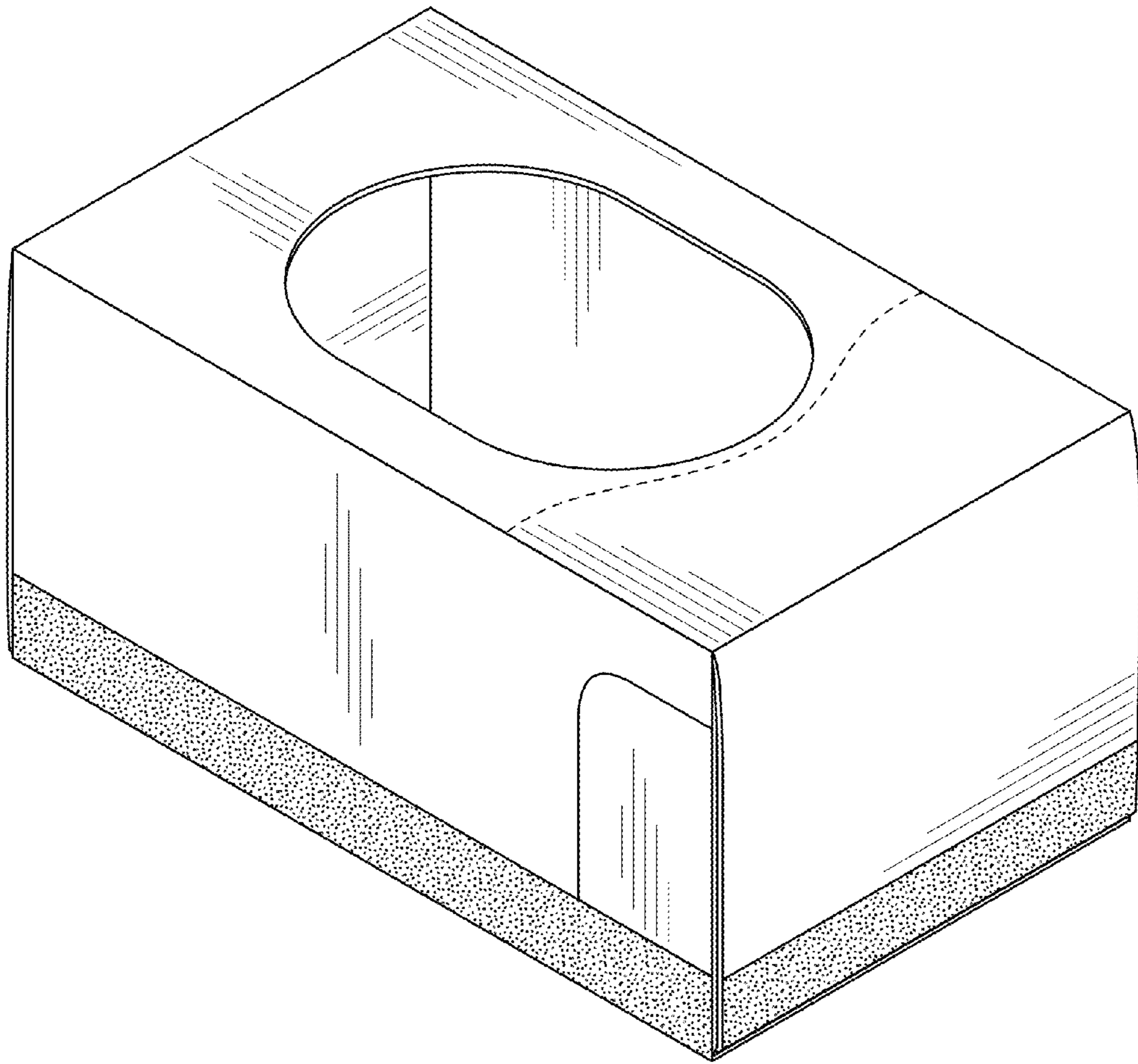

FIG. 2

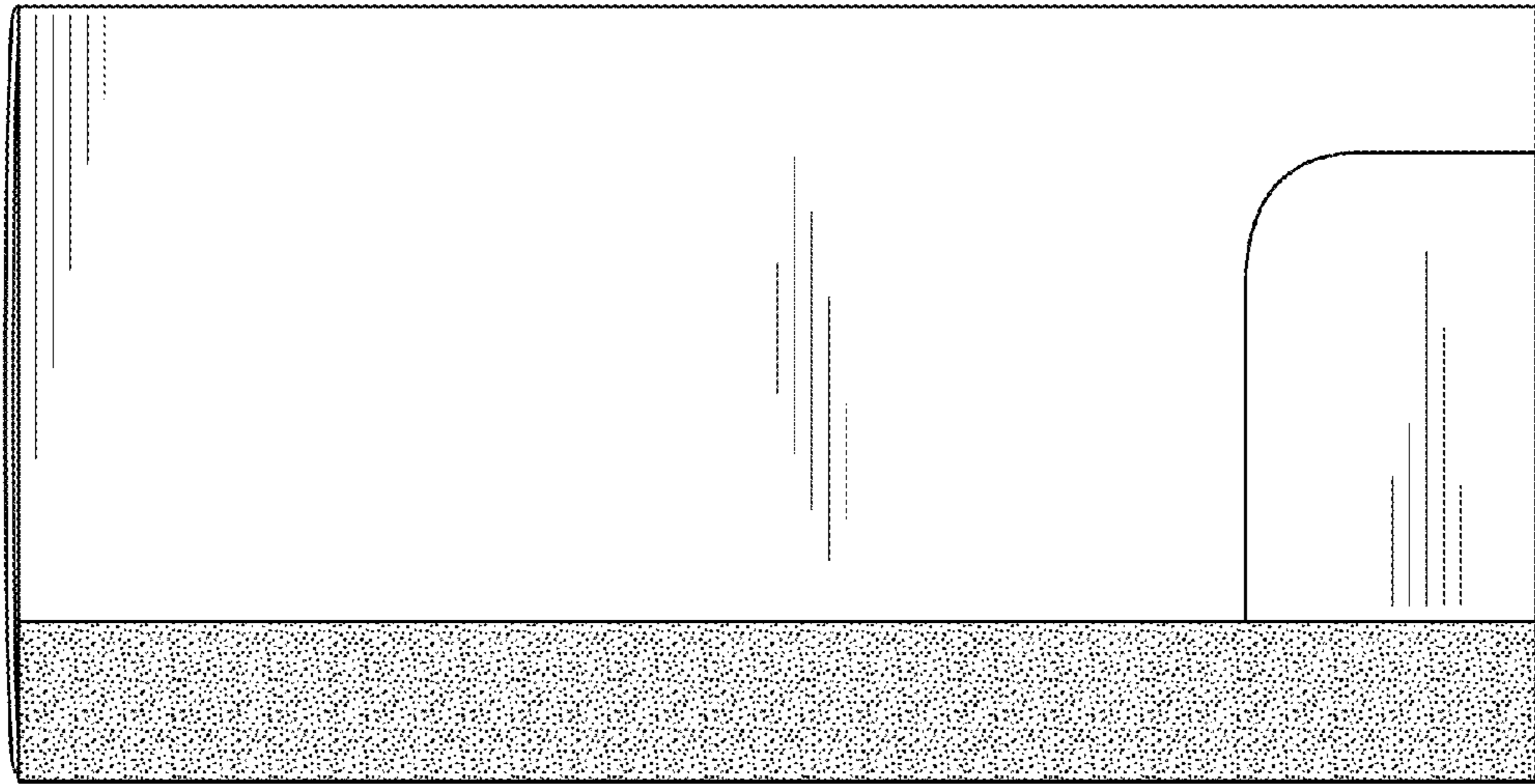

FIG. 3

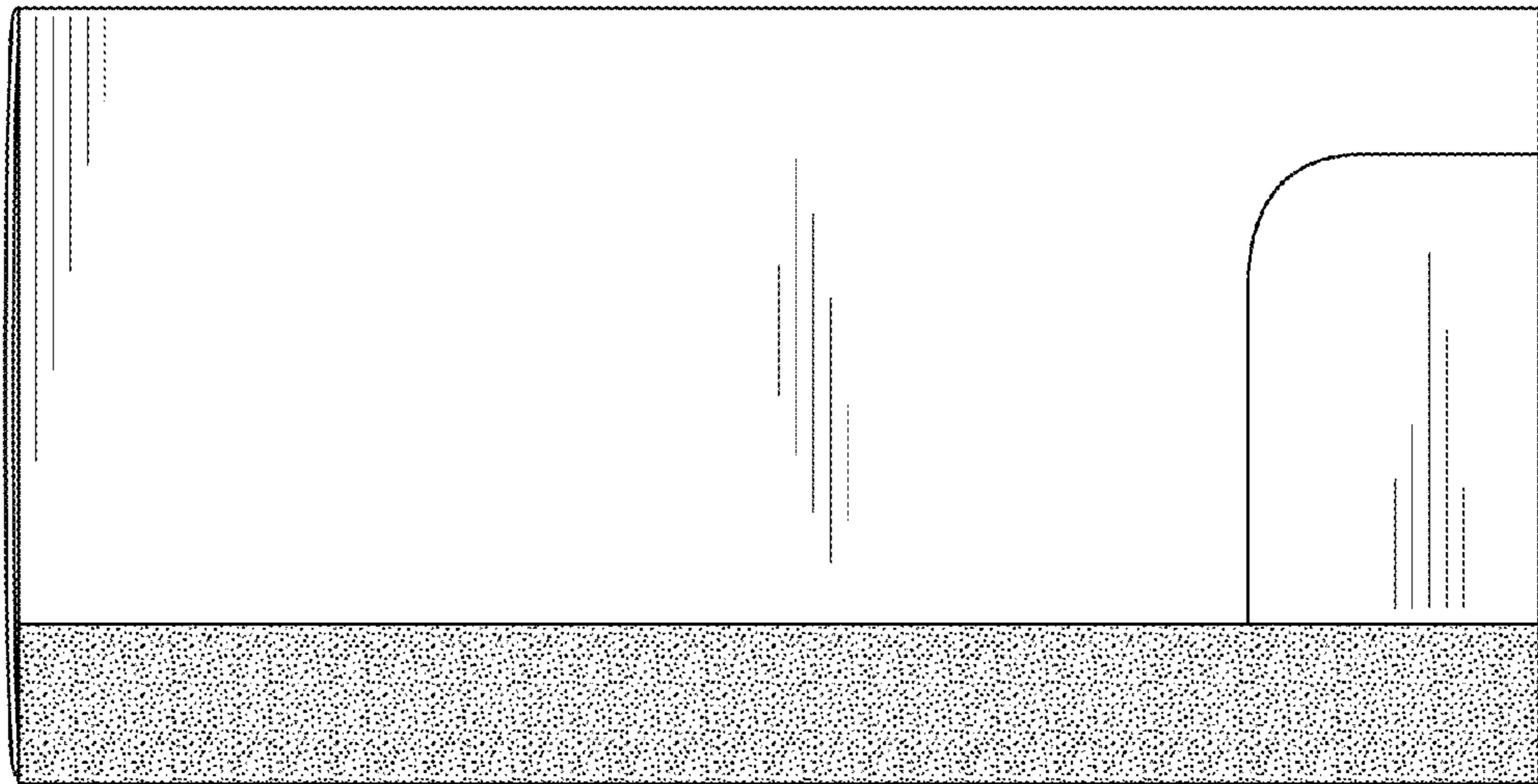

FIG. 4

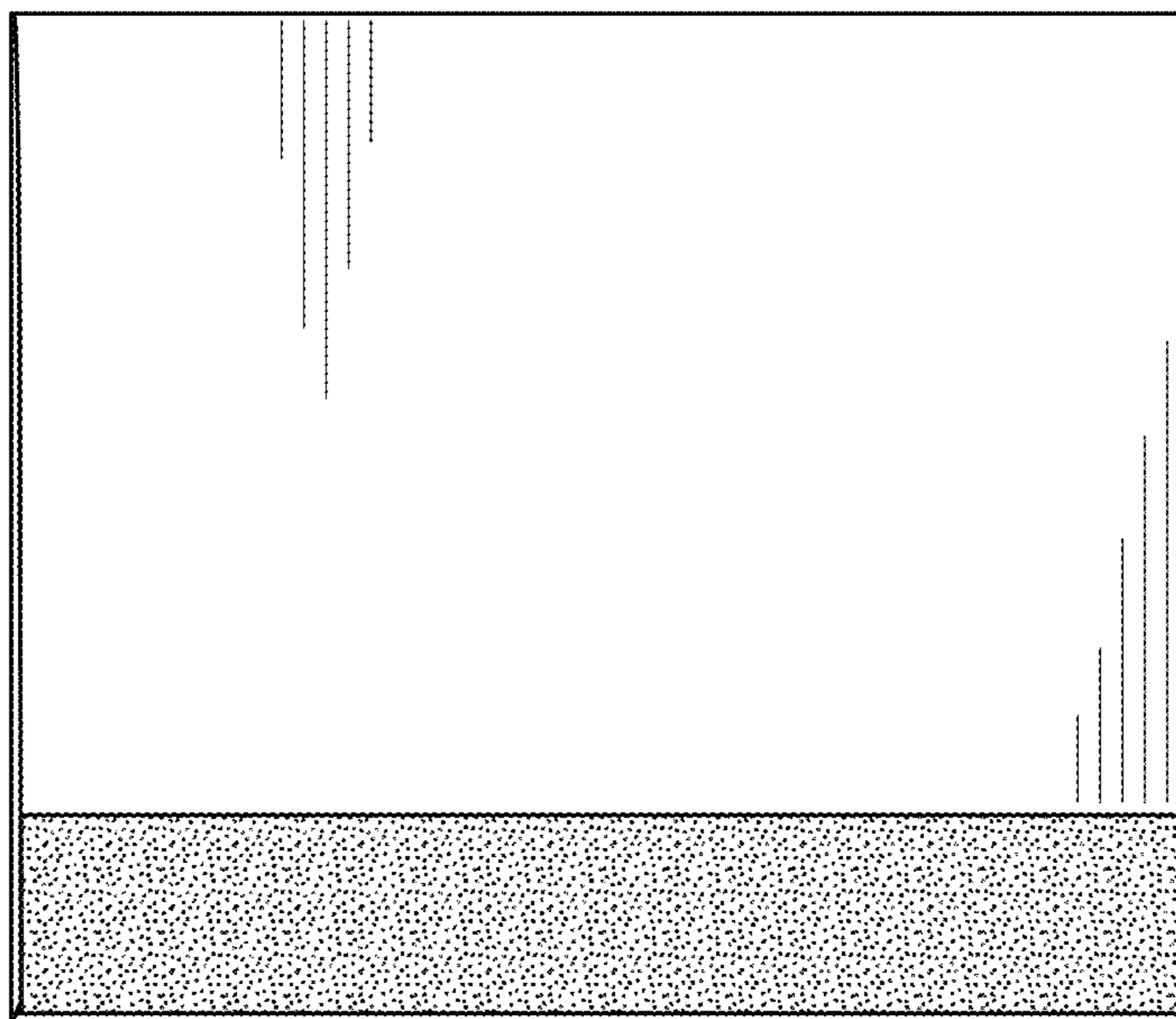

FIG. 5

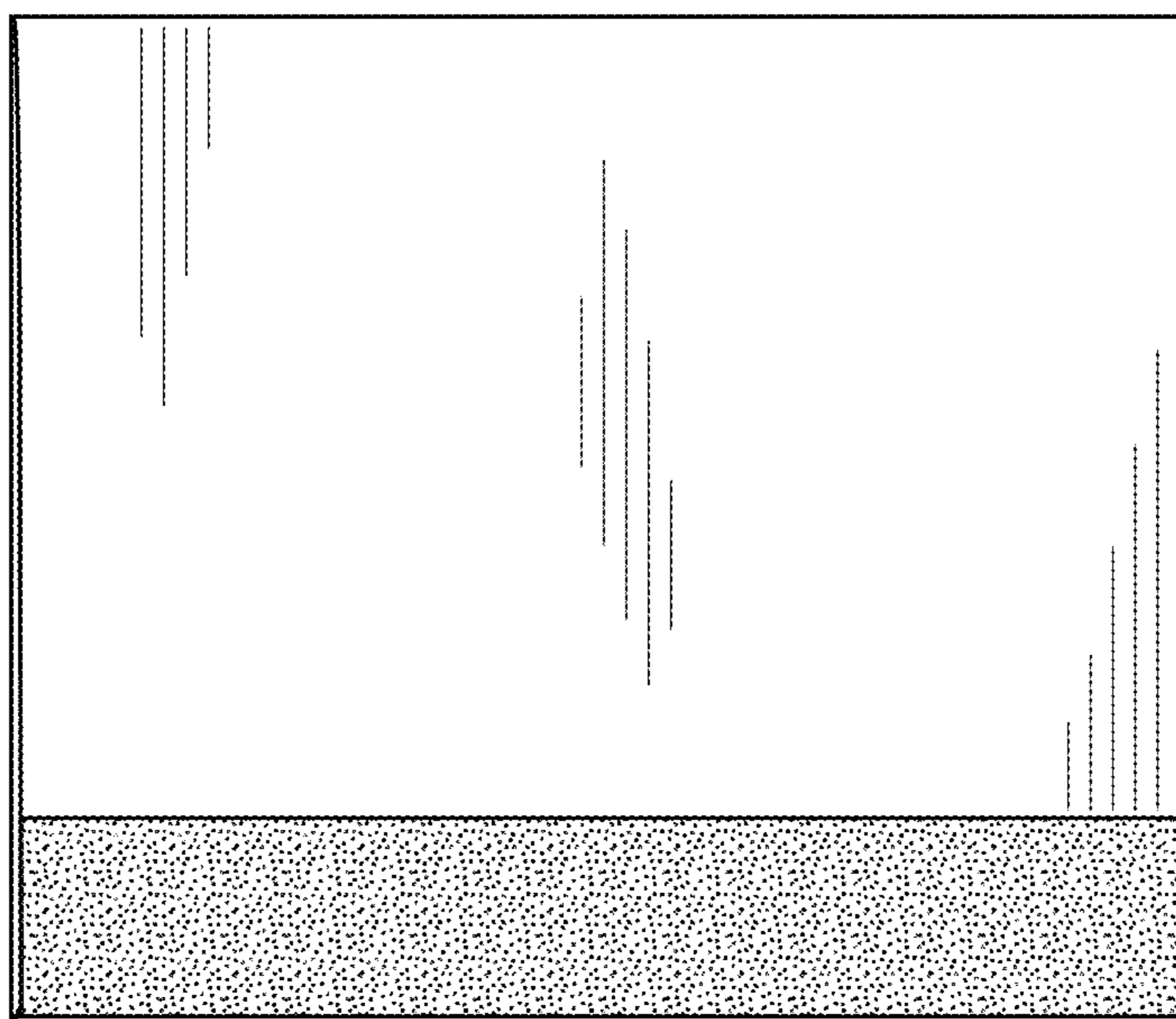

FIG. 6

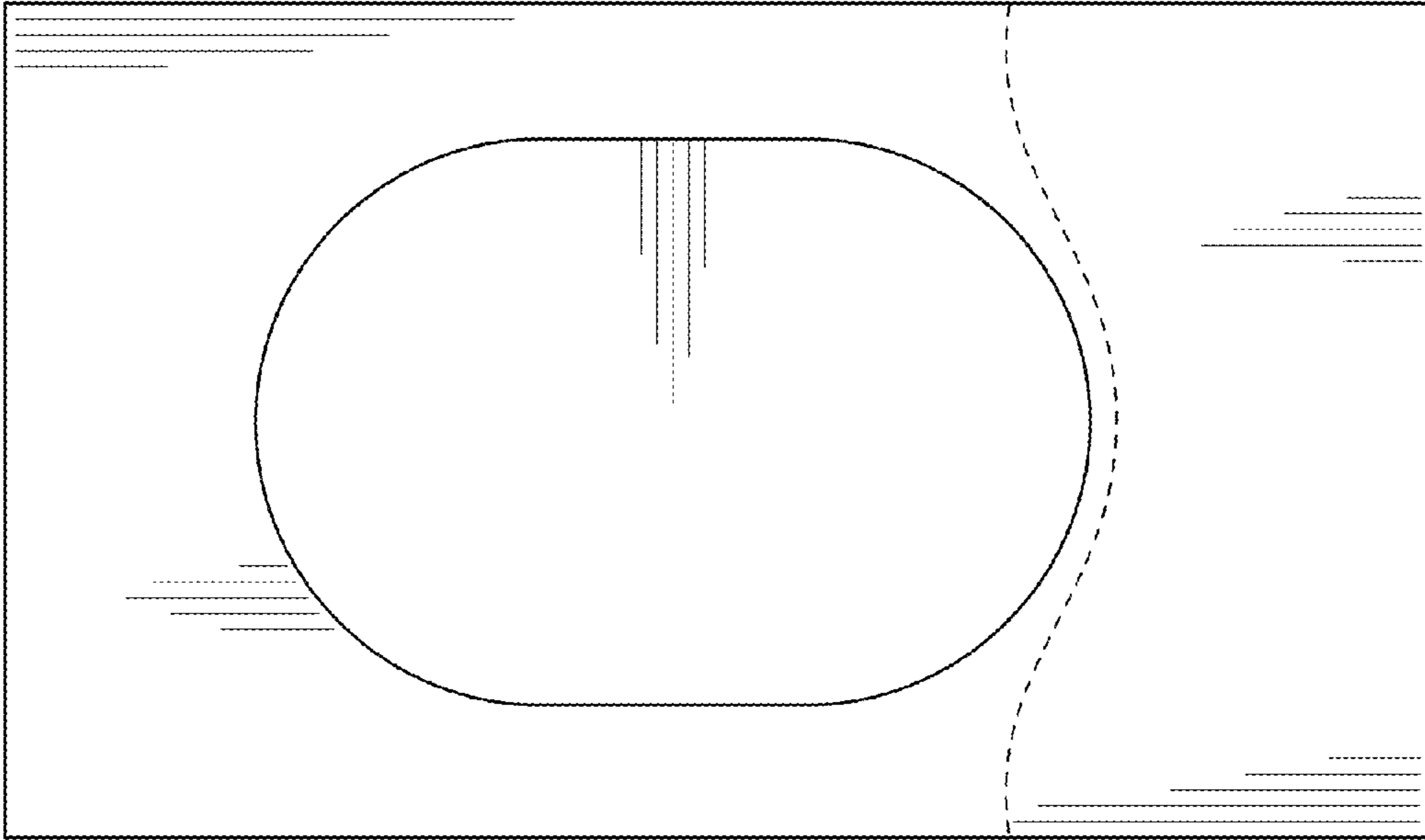

FIG. 7

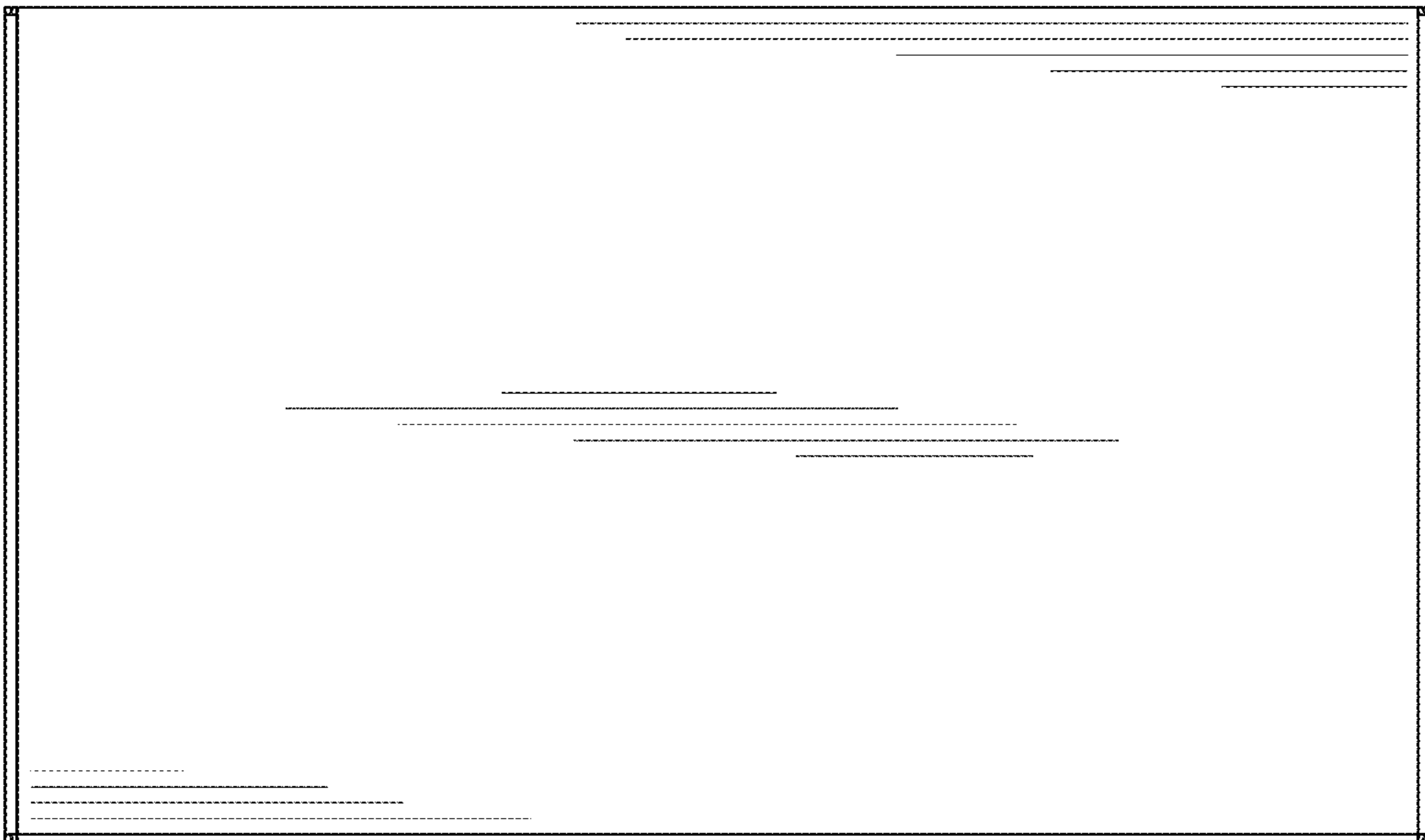

FIG. 8

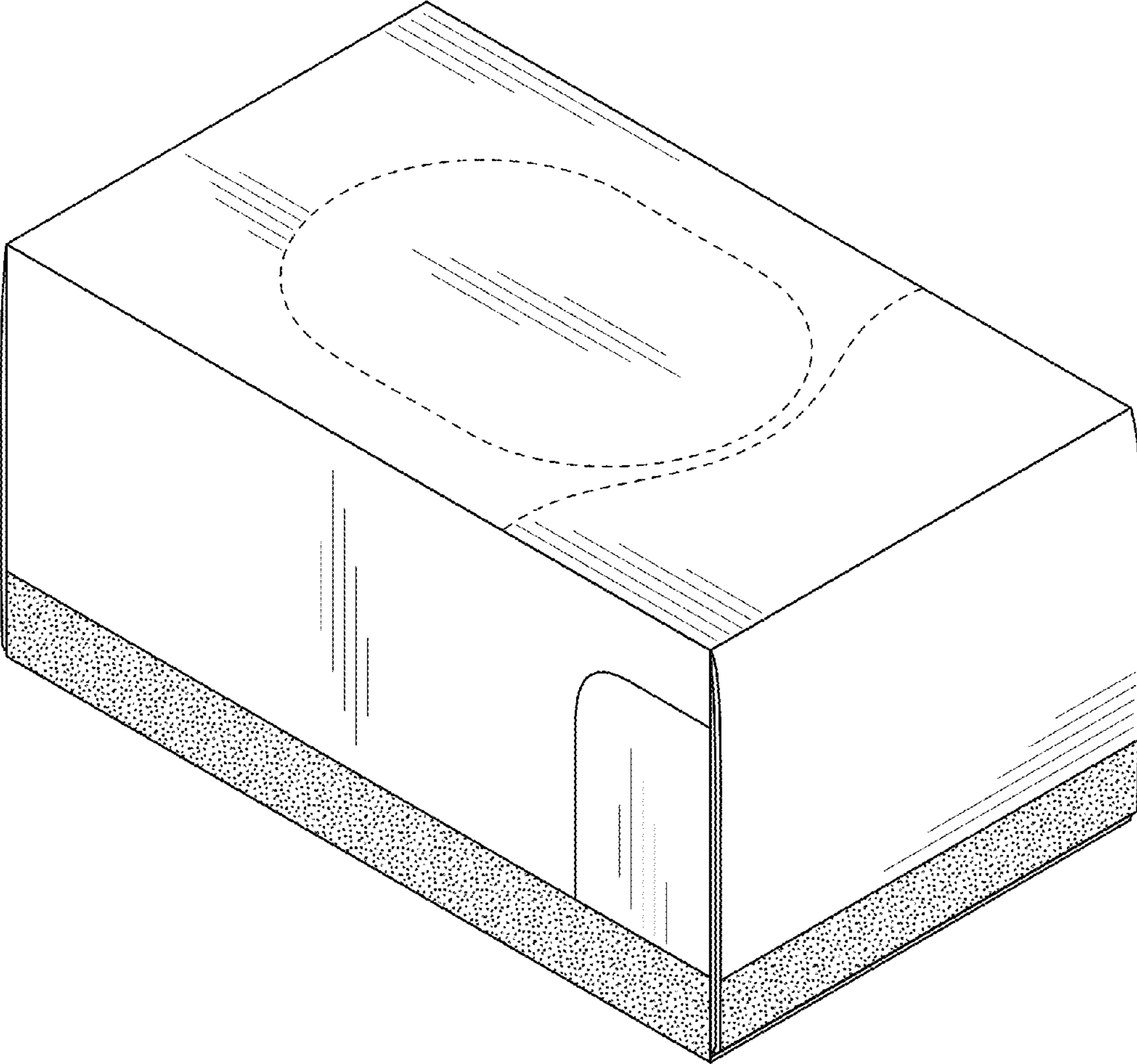

FIG. 9

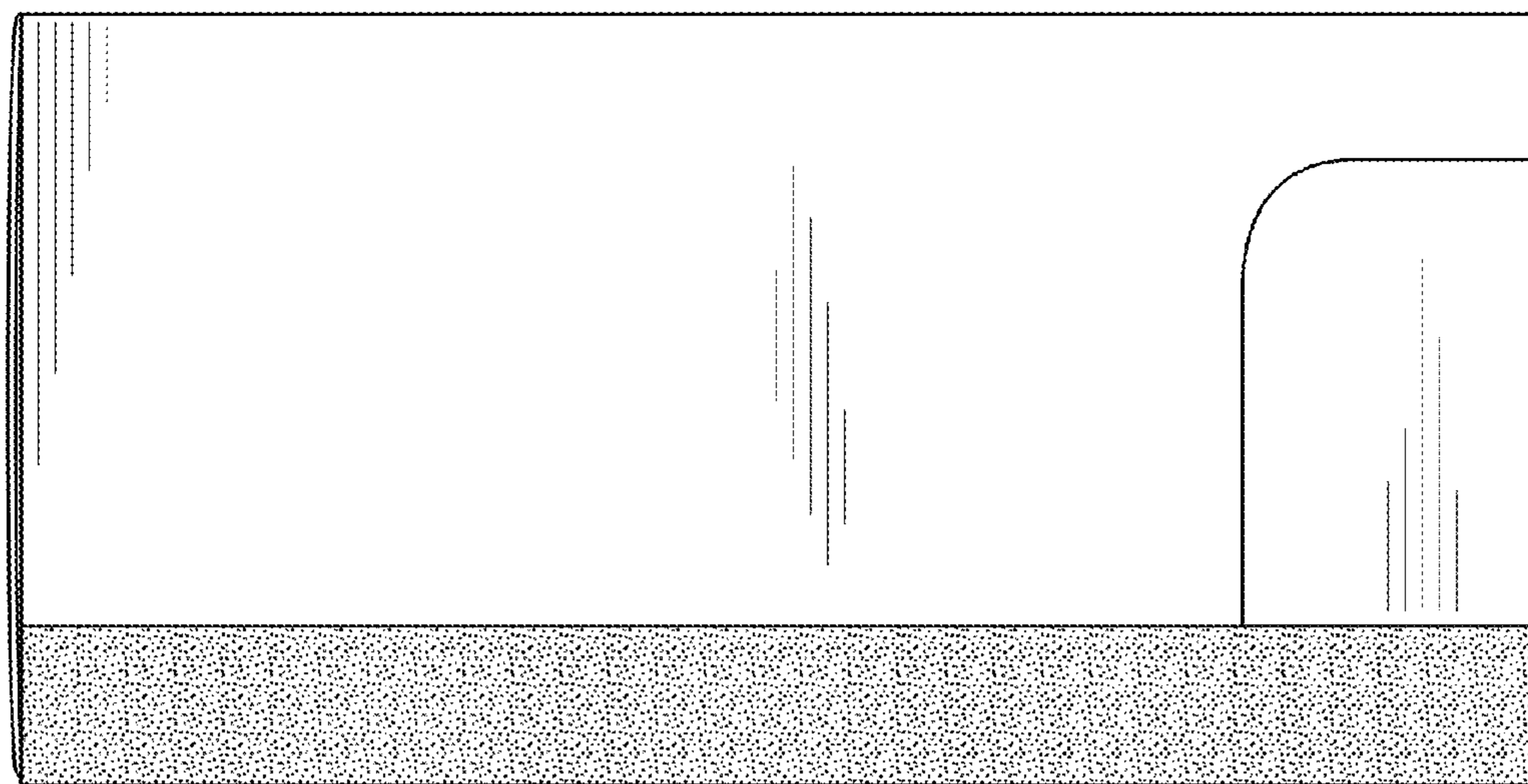

FIG. 10

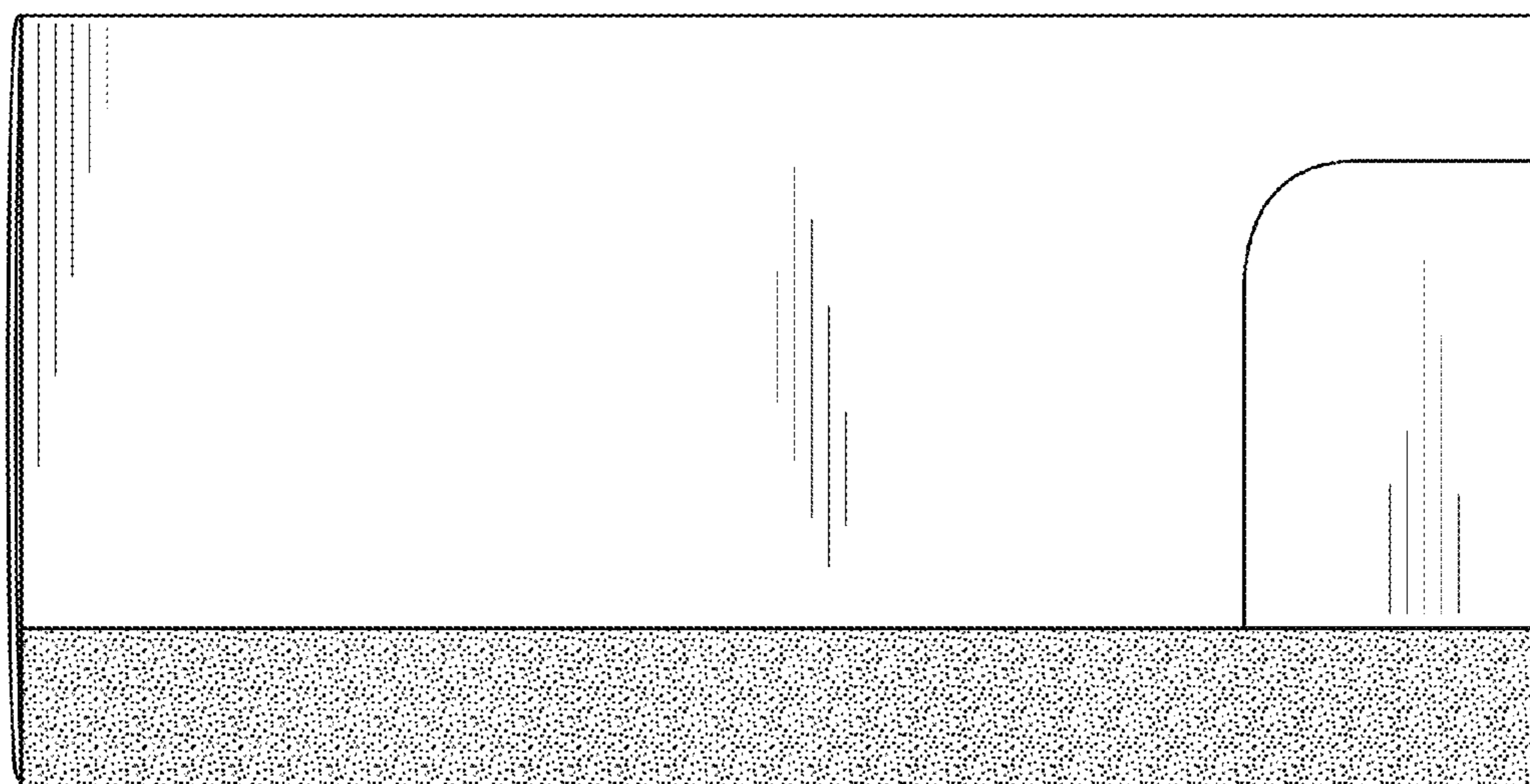

FIG. 11

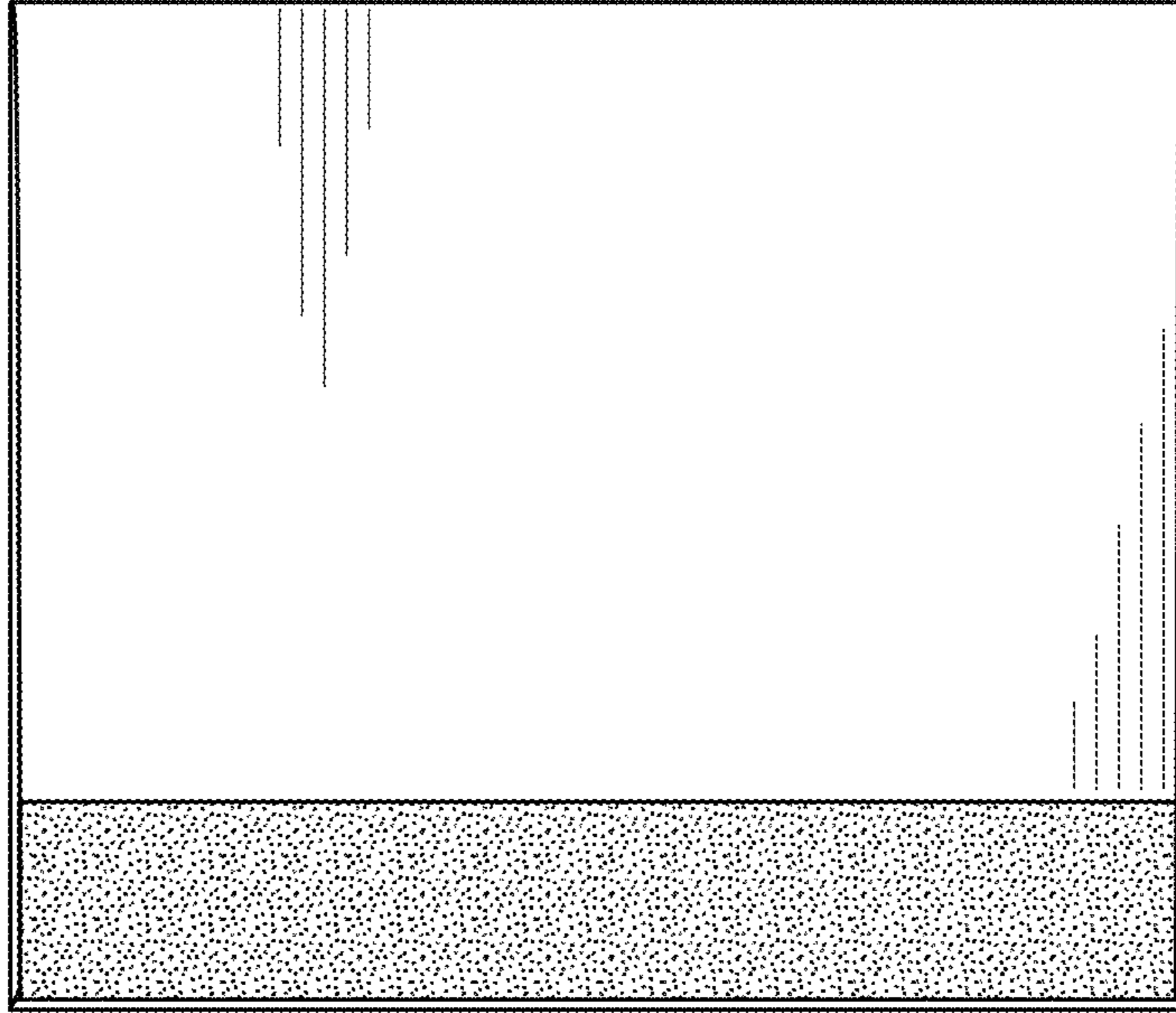

FIG. 12

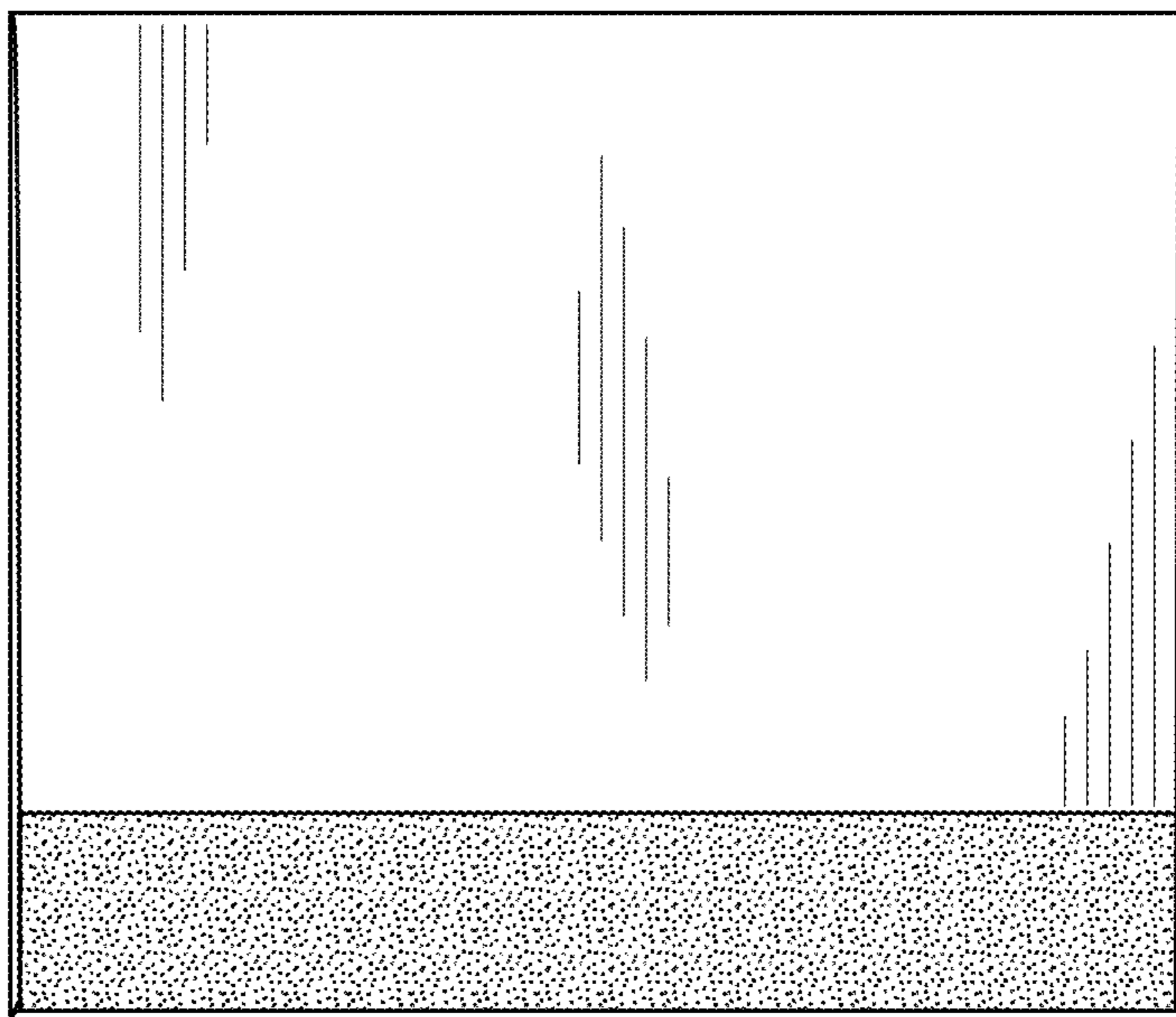

FIG. 13

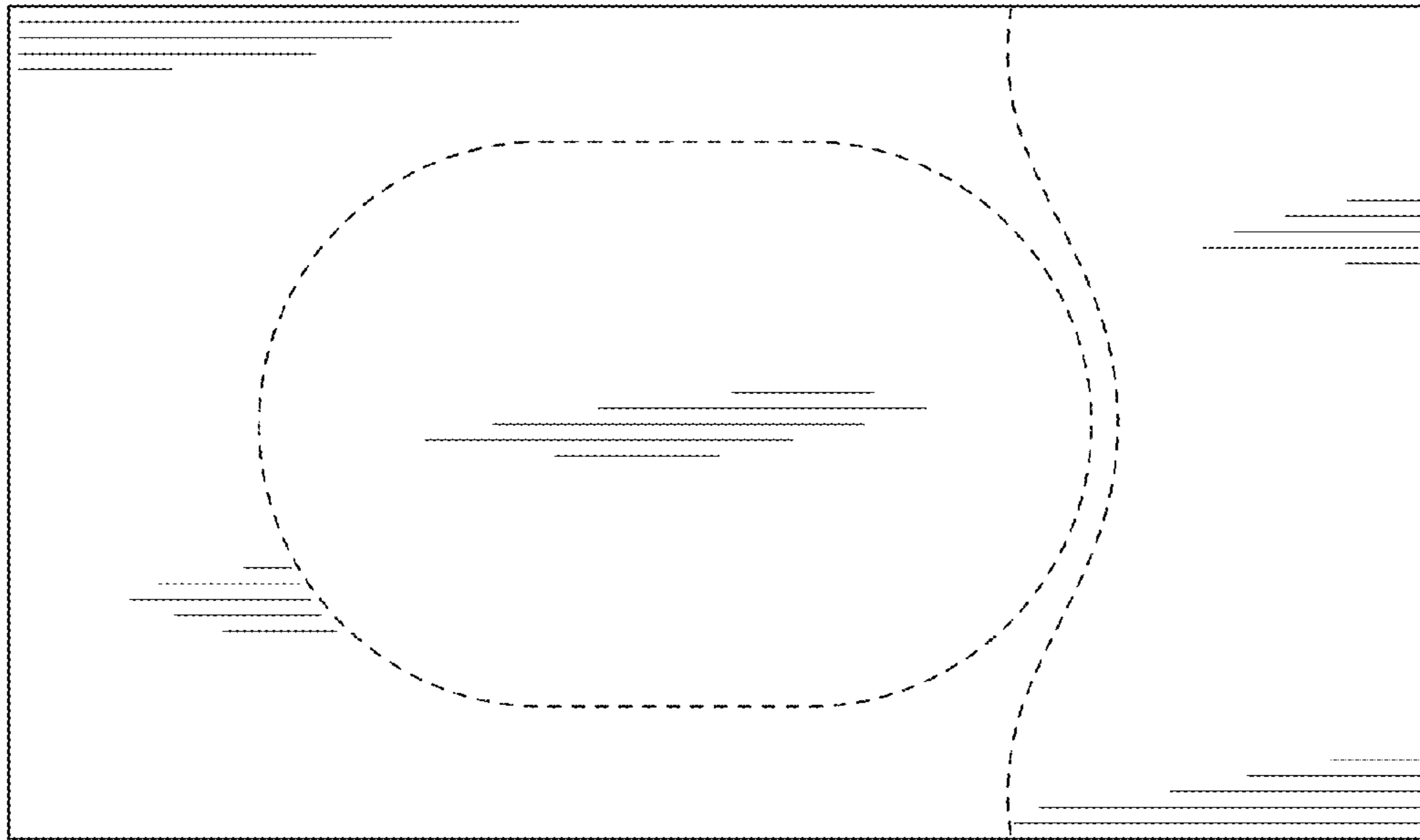

FIG. 14

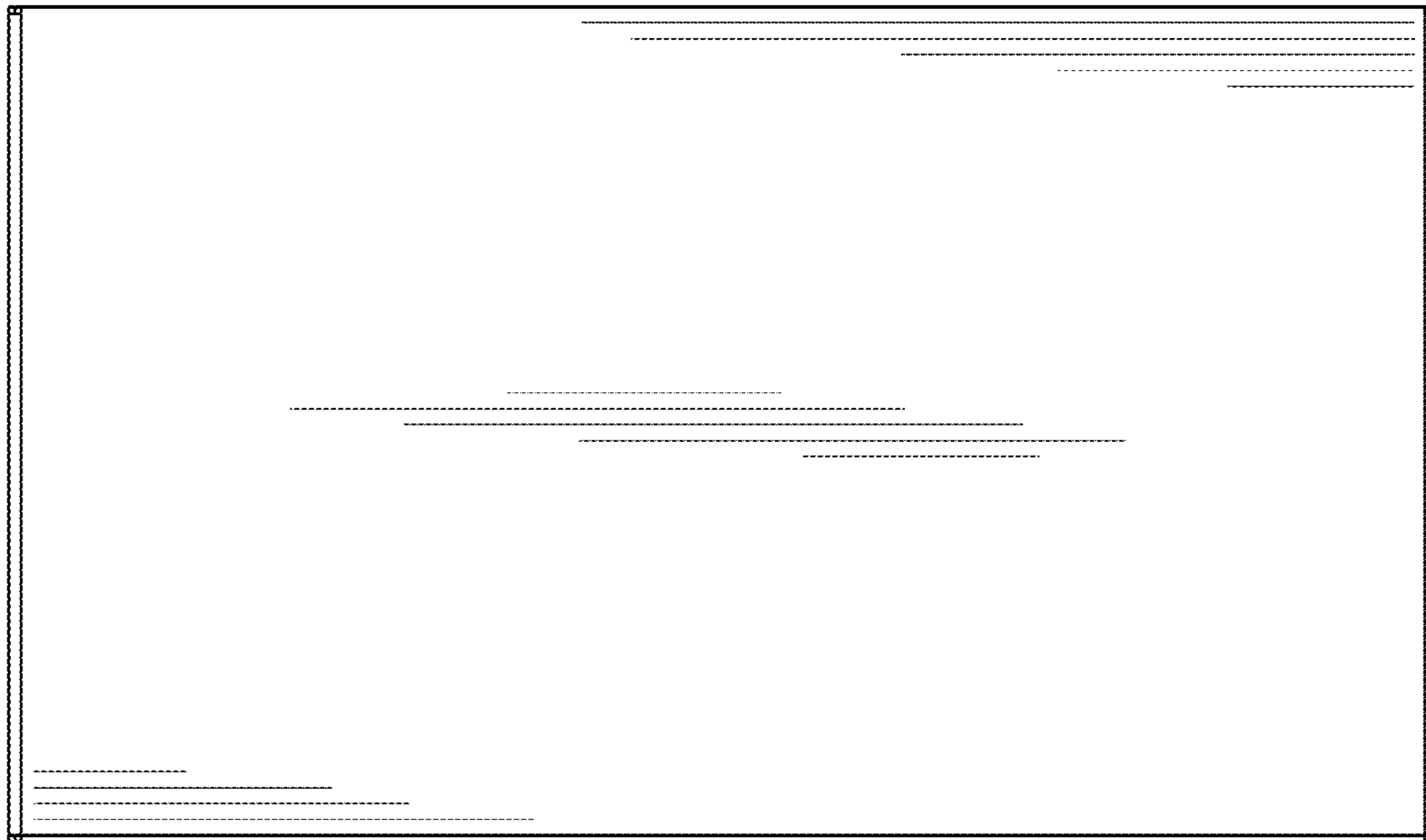

FIG. 15