



US00D710181S

(12) **United States Design Patent**
Christensen et al.

(10) **Patent No.:** **US D710,181 S**
(45) **Date of Patent:** **** Aug. 5, 2014**

(54) **DOOR HINGE**

(75) Inventors: **Jason F. Christensen**, South Jordan, UT (US); **Brent B. Osborne**, Salt Lake City, UT (US); **William J. Hendricks**, Highland, UT (US)

(73) Assignee: **A & K Hinges, LLC**, Salt Lake City, UT (US)

(**) Term: **14 Years**

(21) Appl. No.: **29/423,502**

(22) Filed: **Jun. 1, 2012**

(51) **LOC (10) Cl.** **08-06**

(52) **U.S. Cl.**
USPC **D8/323**

(58) **Field of Classification Search**
USPC D8/323, 327, 328; D23/303; 4/236, 4/240; 16/225, 250, 682, 309, 235, 275, 16/244, 379, 390, 430, 241, 238, 245, 236, 16/243, 242, 385, 331
See application file for complete search history.

(56) **References Cited**

U.S. PATENT DOCUMENTS

1,620,701 A * 3/1927 Teich 16/339
2,488,688 A * 11/1949 Simmons 16/353

(Continued)

Primary Examiner — Cynthia Underwood

(74) *Attorney, Agent, or Firm* — Workman Nydegger

(57) **CLAIM**

The ornamental design for a door hinge, as shown and described.

DESCRIPTION

FIG. 1 is a perspective view of a first embodiment of a door hinge according to the present invention;
FIG. 2 is a front view of the door hinge of FIG. 1;

FIG. 3 is a back view of the door hinge of FIG. 1;
FIG. 4 is a first side view of the door hinge of FIG. 1;
FIG. 5 is a second, opposite side view of the door hinge of FIG. 1;
FIG. 6 is a top view of the door hinge of FIG. 1;
FIG. 7 is a bottom view of the door hinge of FIG. 1;
FIG. 8 is an similar perspective view to that shown in FIG. 1, but in which the door hinge is closed;
FIG. 9 is an exploded perspective view of the door hinge of FIG. 1;
FIG. 10 is an exploded front view of the door hinge of FIG. 1;
FIG. 11 is an exploded back view of the door hinge of FIG. 1;
FIG. 12 is an exploded first side view of the door hinge of FIG. 1;
FIG. 13 is an exploded second, opposite side view of the door hinge of FIG. 1;
FIG. 14 is an exploded top view of the door hinge of FIG. 1;
FIG. 15 is an exploded bottom view of the door hinge of FIG. 1;
FIG. 16 is a perspective view of a second embodiment of a door hinge according to the present invention;
FIG. 17 is a front view of the door hinge of FIG. 16;
FIG. 18 is a back view of the door hinge of FIG. 16;
FIG. 19 is a first side view of the door hinge of FIG. 16;
FIG. 20 is a second, opposite side view of the door hinge of FIG. 16;
FIG. 21 is a top view of the door hinge of FIG. 16;
FIG. 22 is a bottom view of the door hinge of FIG. 16; and
FIG. 23 is a similar perspective view to that shown in FIG. 16, but in which the door hinge is closed.
FIG. 24 is a perspective view of a third embodiment of a door hinge according to the present invention;
FIG. 25 is a front view of the door hinge of FIG. 24;
FIG. 26 is a back view of the door hinge of FIG. 24;
FIG. 27 is a first side view of the door hinge of FIG. 24;
FIG. 28 is a second, opposite side view of the door hinge of FIG. 24;
FIG. 29 is a top view of the door hinge of FIG. 24;
FIG. 30 is a bottom view of the door hinge of FIG. 24; and
FIG. 31 is a similar perspective view to that shown in FIG. 24, but in which the door hinge is closed.
The broken lines shown are directed to environmental structure and are for illustrative purposes only. The broken lines form no part of the claimed design.

1 Claim, 19 Drawing Sheets

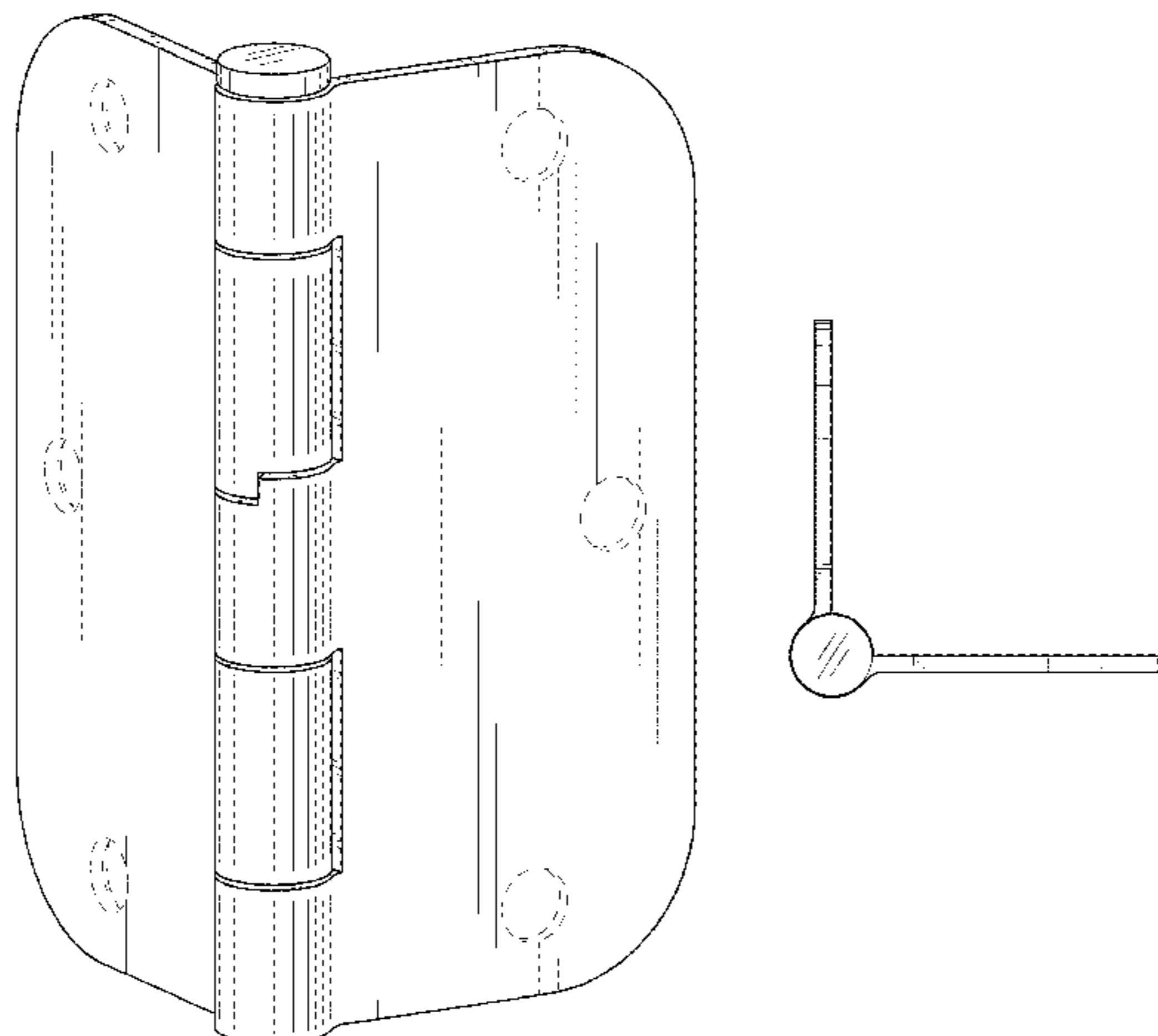

(56)

References Cited

U.S. PATENT DOCUMENTS

2,803,850	A *	8/1957	Hooper	16/341	7,162,774	B1 *	1/2007	Von Resch et al.	16/236
3,965,533	A *	6/1976	Frohlich	16/300	7,328,480	B2 *	2/2008	Schoemann	16/225
5,173,993	A *	12/1992	Baker	16/329	D584,130	S *	1/2009	Bertani	D8/328
D376,971	S *	12/1996	Schutz	D8/327	7,676,887	B2 *	3/2010	Chung	16/236
5,765,263	A *	6/1998	Bolinas et al.	16/342	D622,576	S *	8/2010	Farkas et al.	D8/328
6,212,734	B1 *	4/2001	Commons	16/244	7,861,374	B2 *	1/2011	Verdicchio	16/225
6,353,967	B1	3/2002	Escobar et al.			D636,251	S *	4/2011	Herglotz et al.	D8/328
						D644,499	S *	9/2011	Herglotz et al.	D8/327
						8,307,513	B1 *	11/2012	Fitzgerald	16/386

* cited by examiner

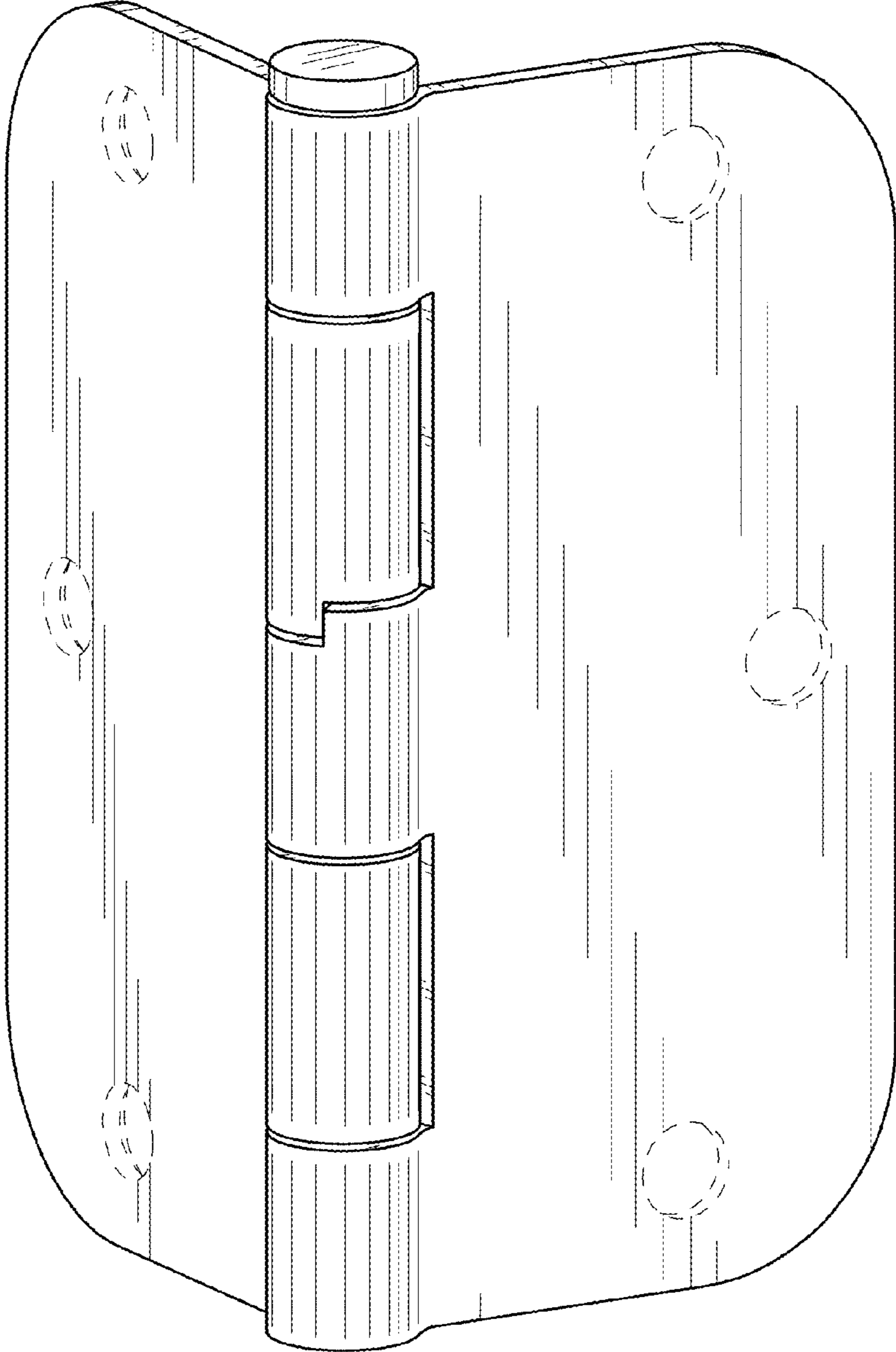

FIG. 1

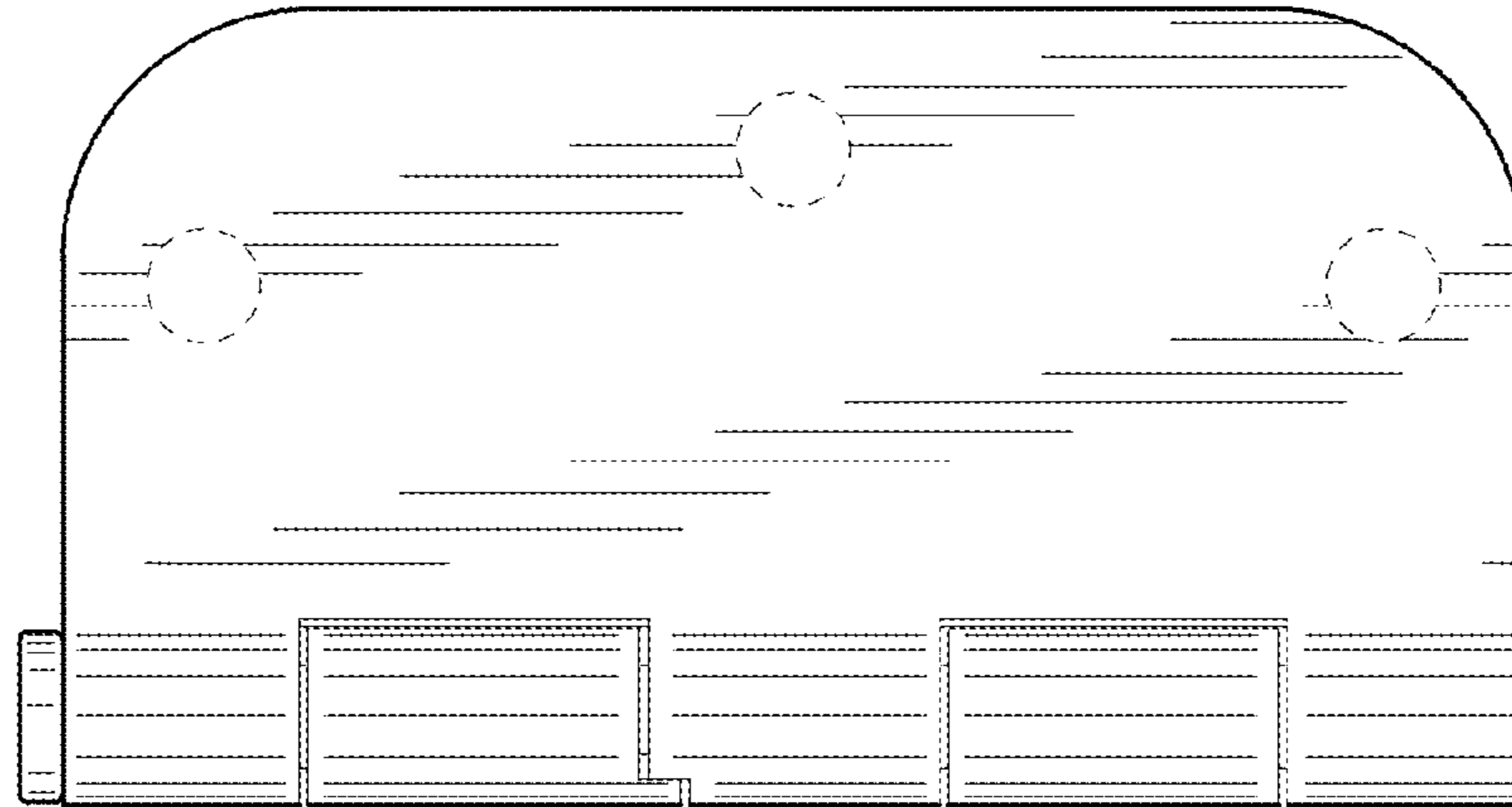

FIG. 3

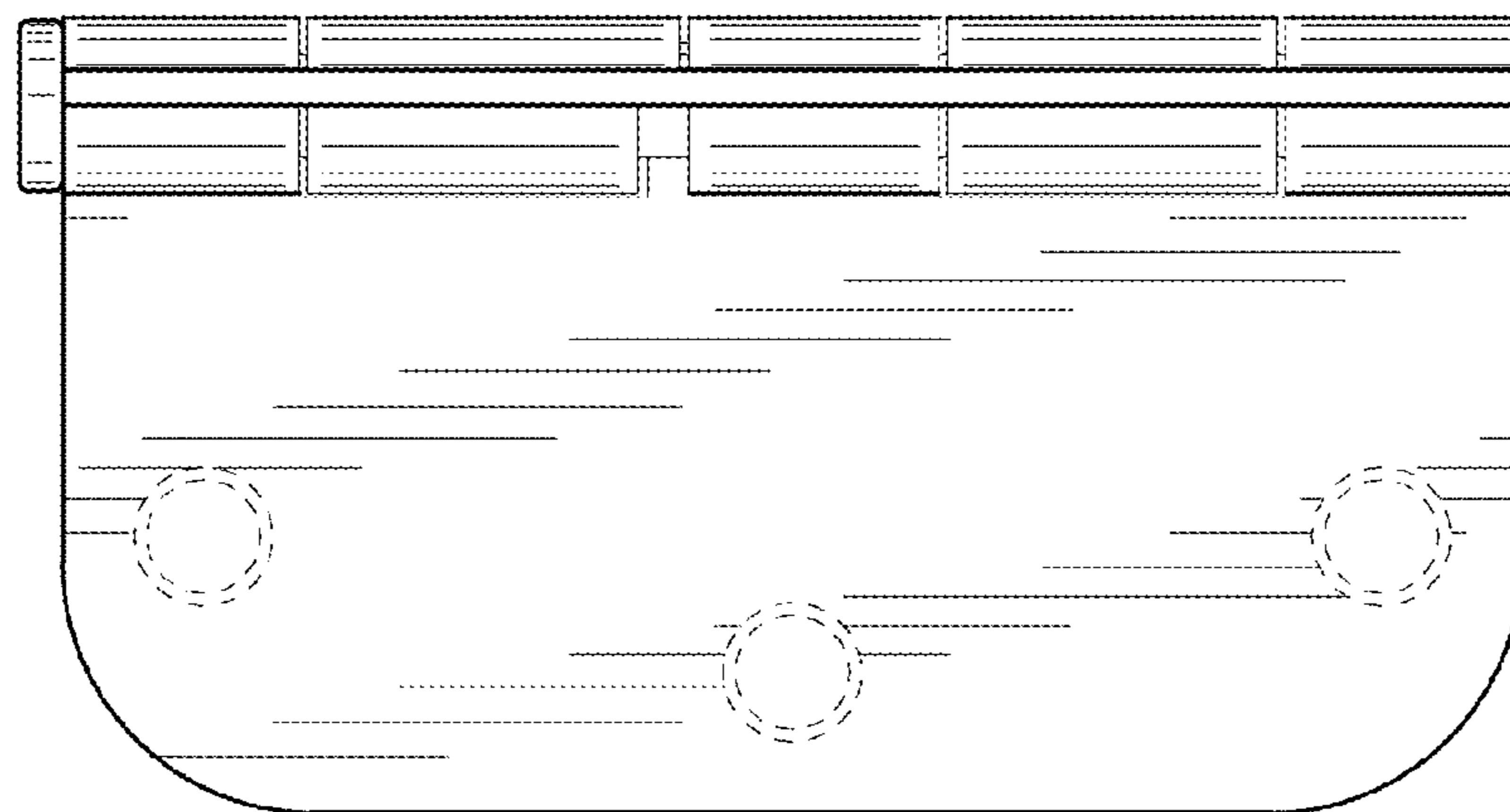

FIG. 2

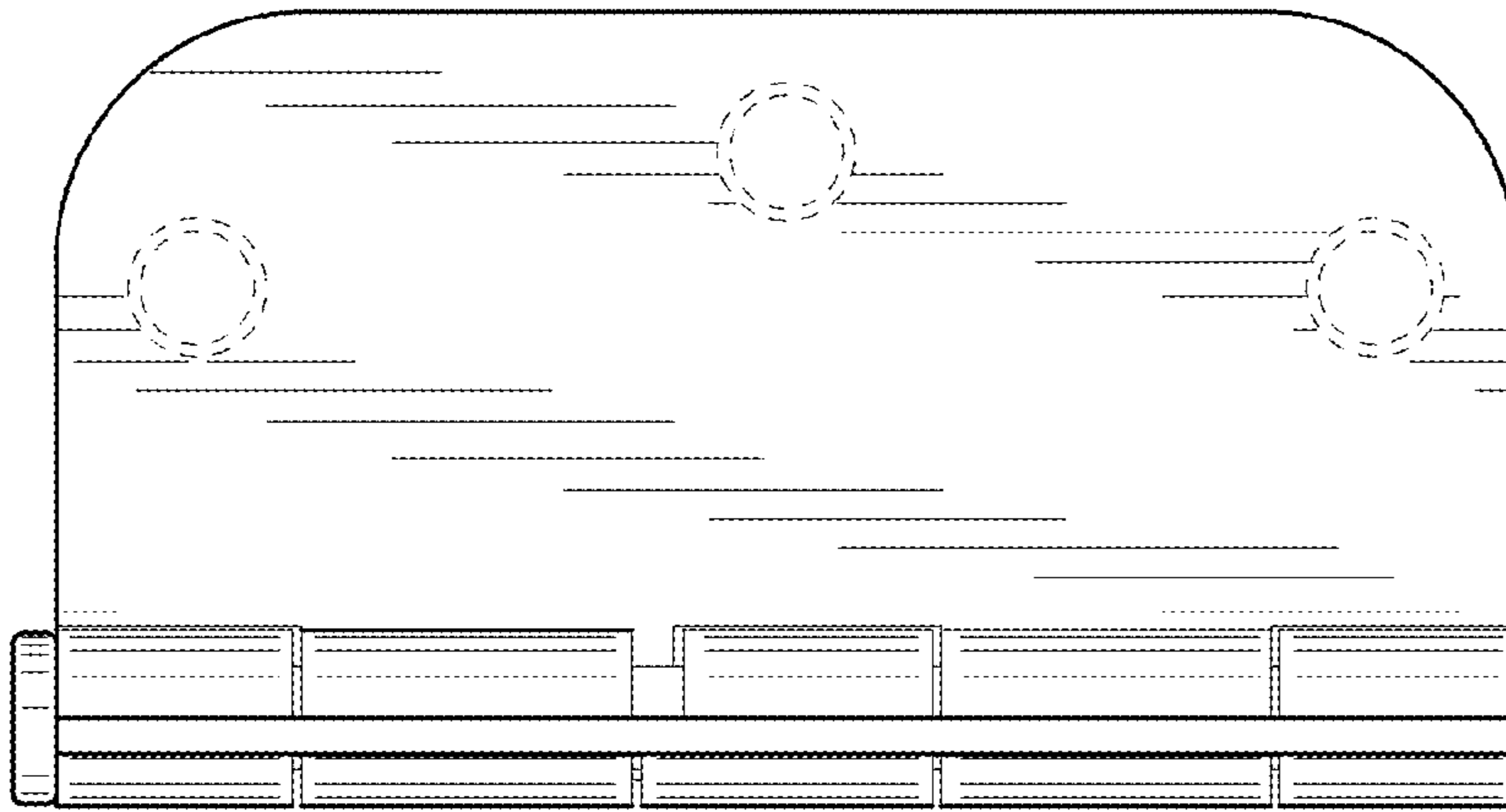

FIG. 5

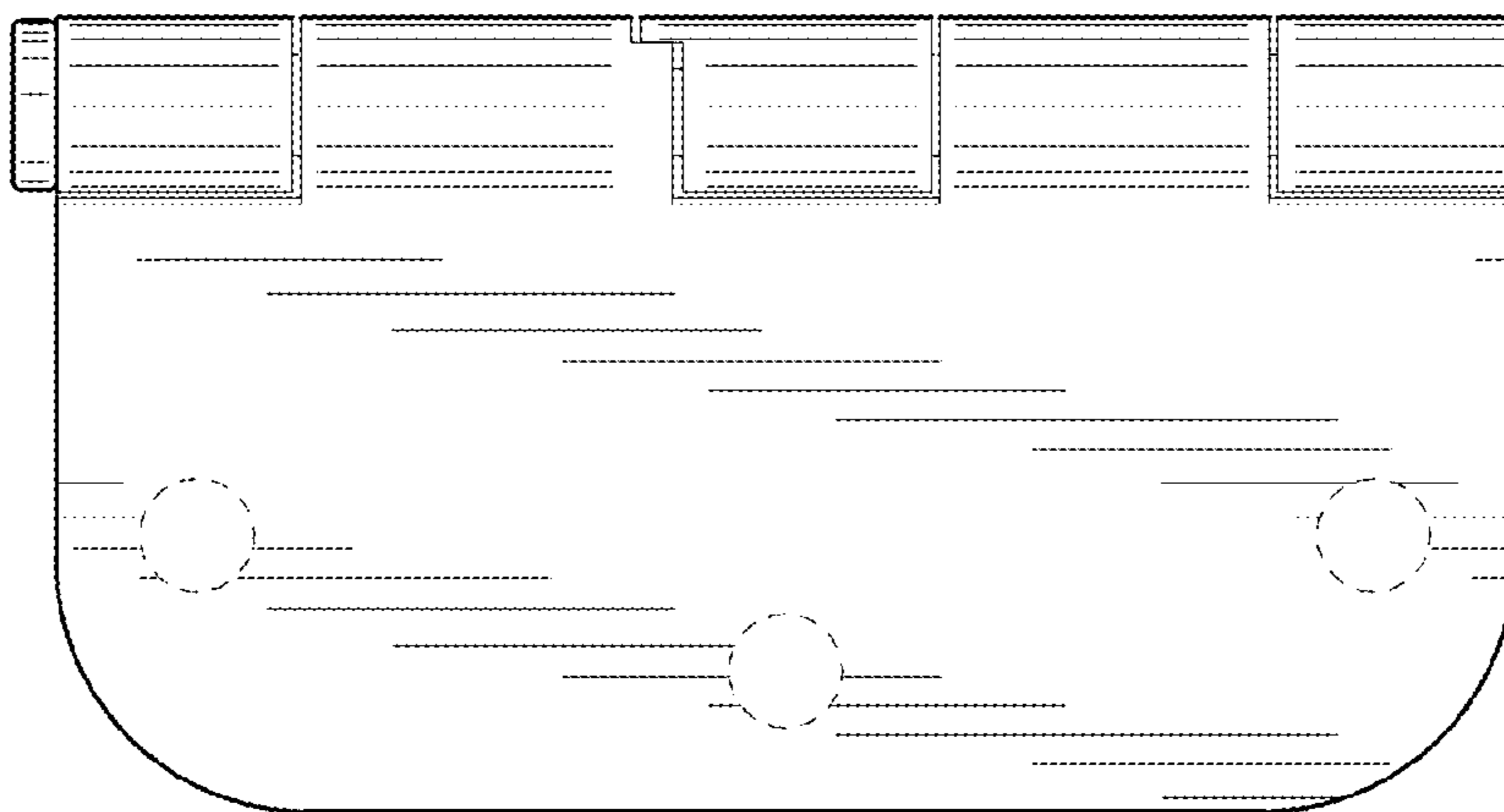

FIG. 4

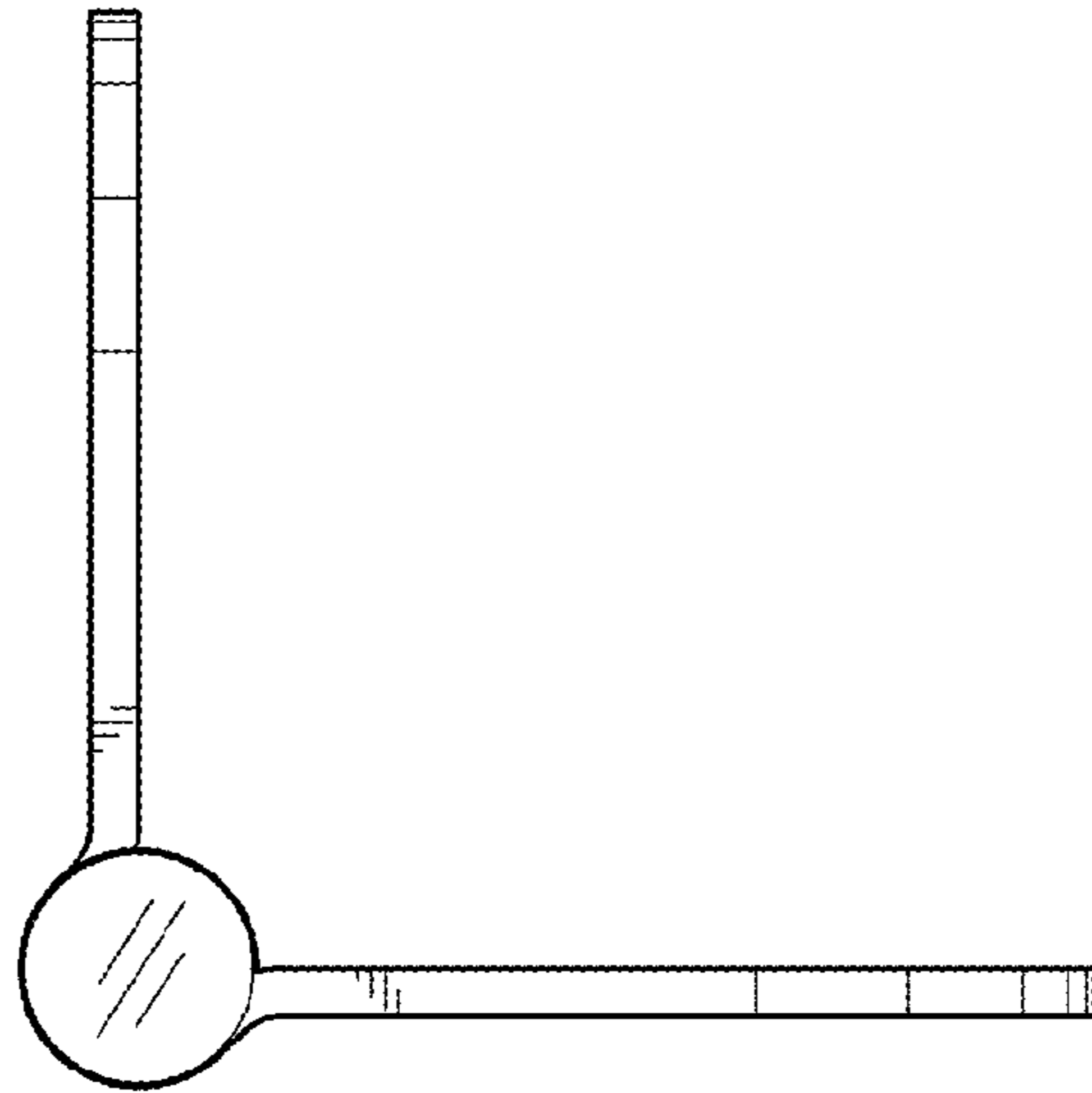

FIG. 6

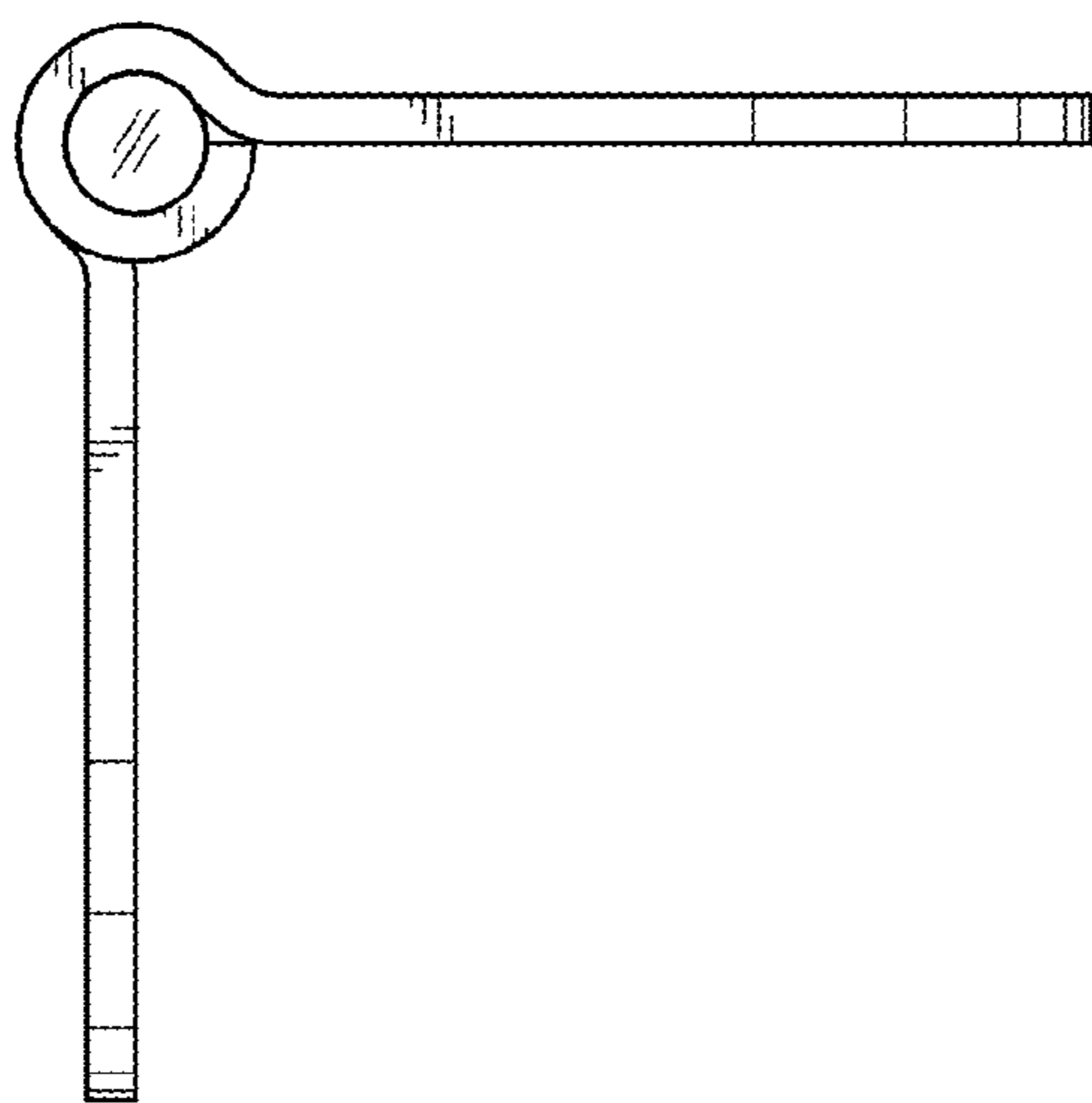

FIG. 7

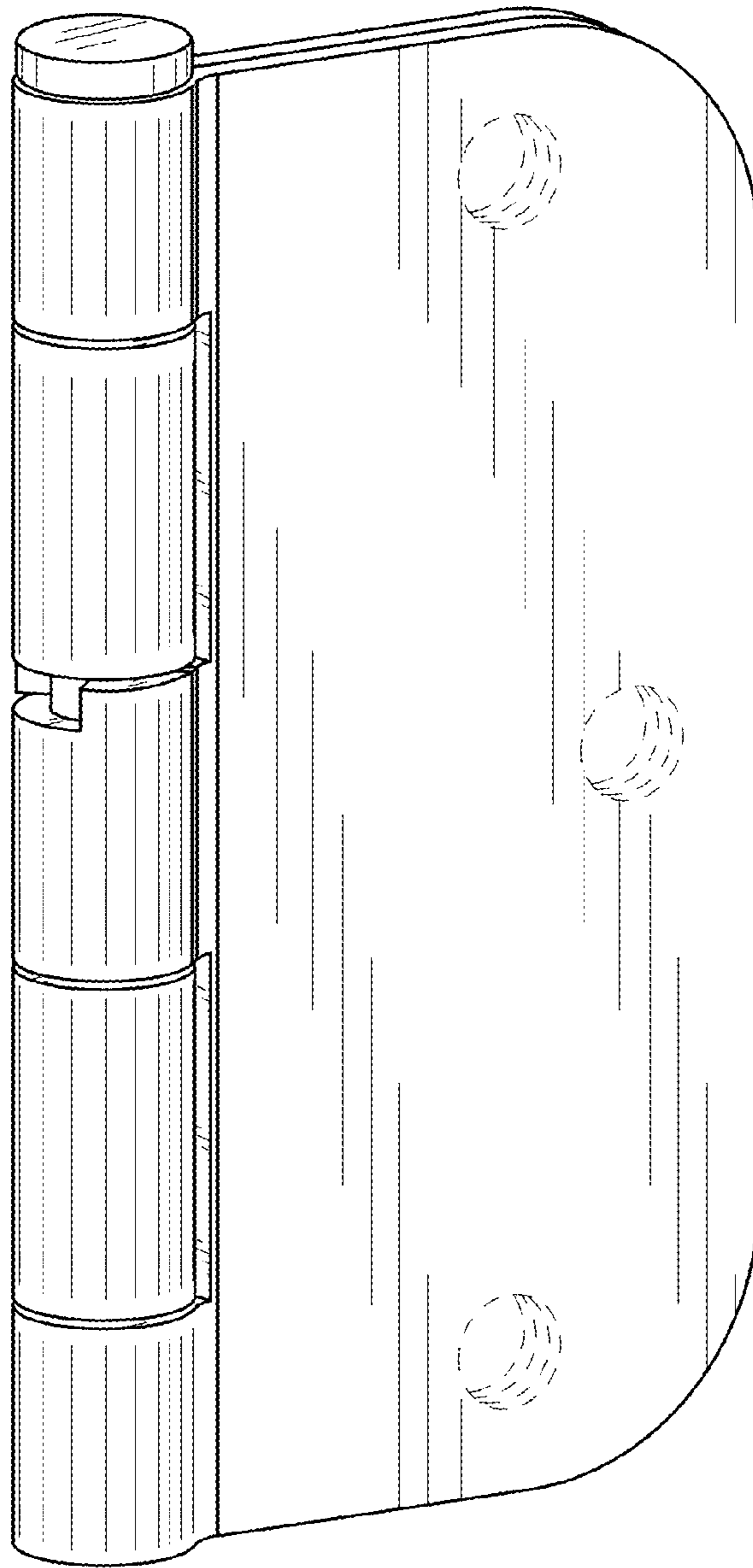

FIG. 8

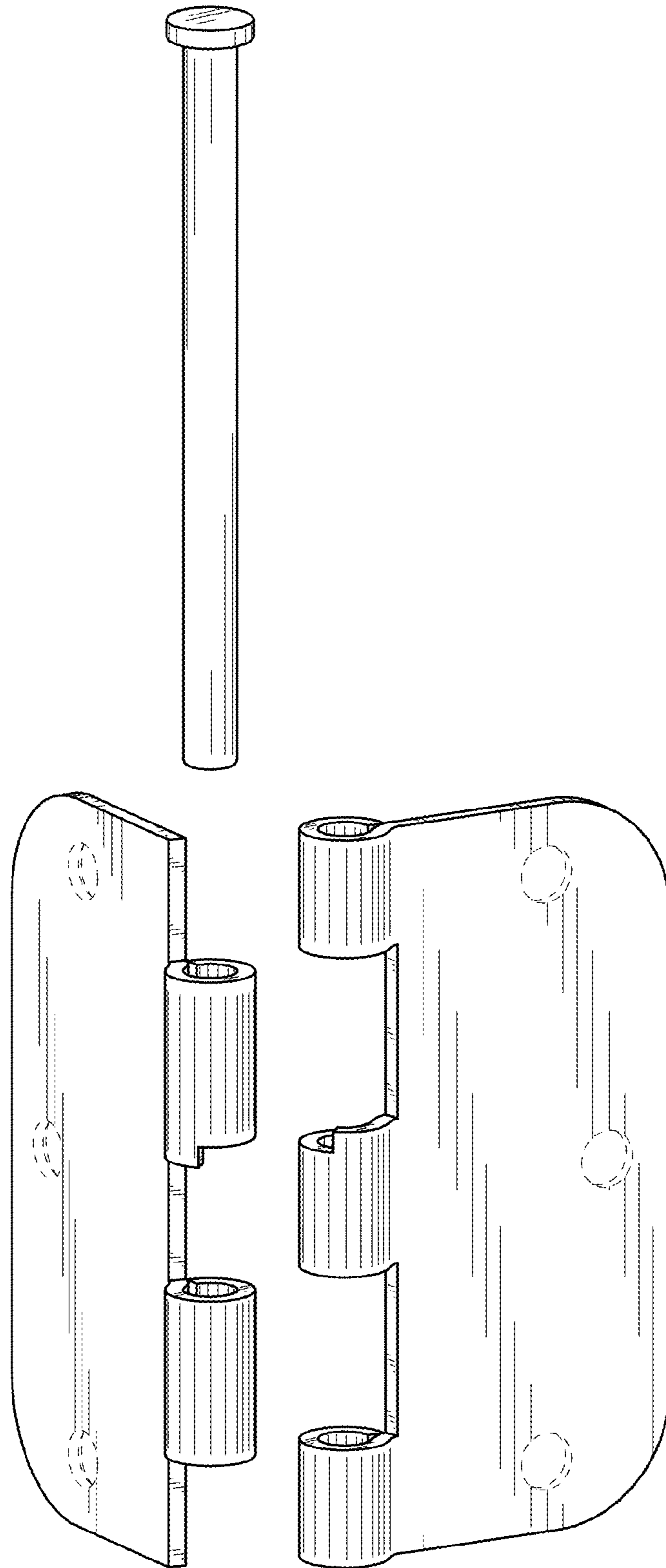

FIG. 9

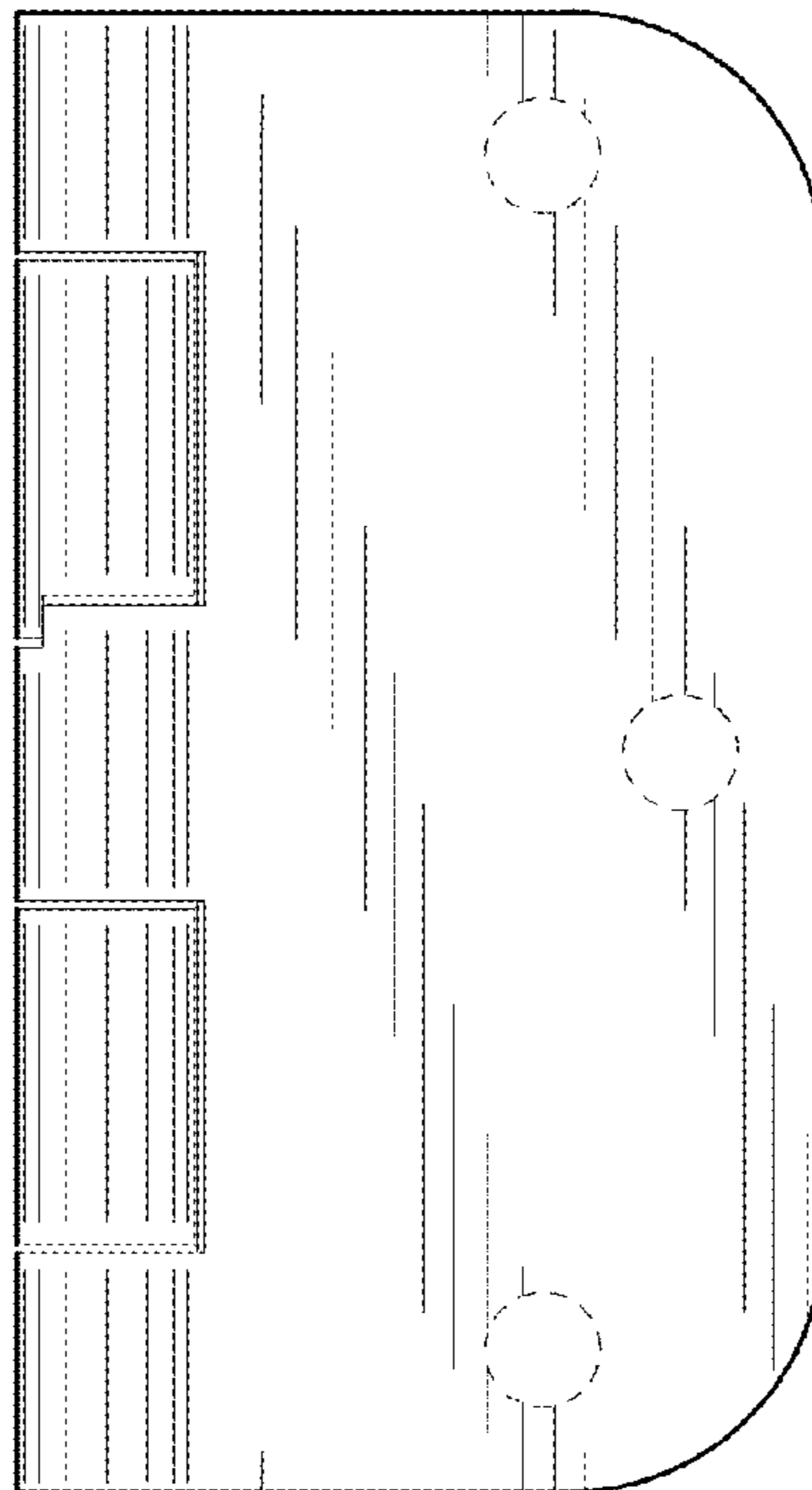
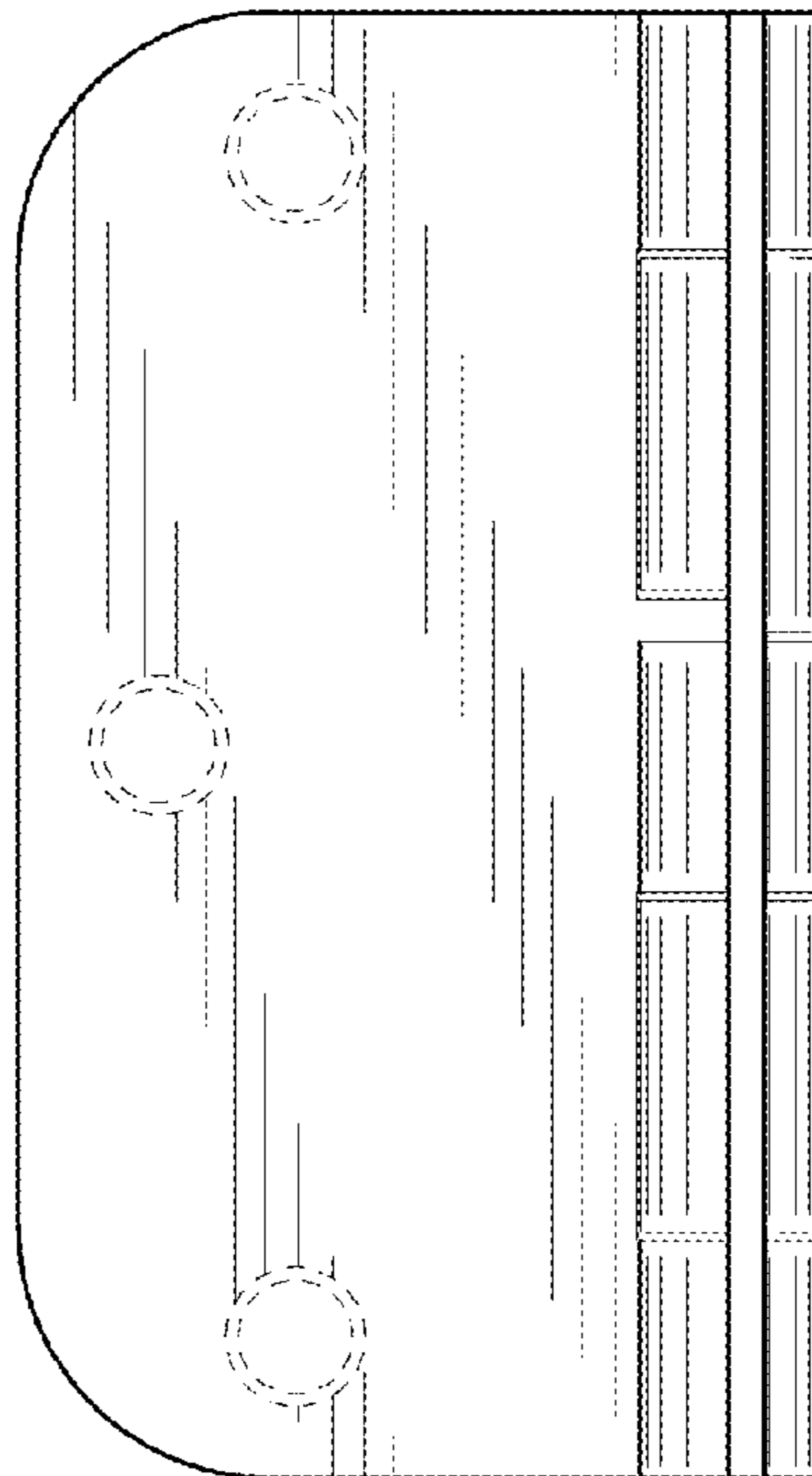
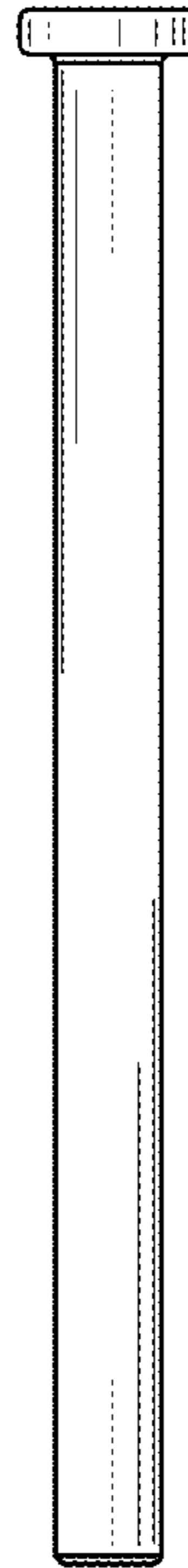
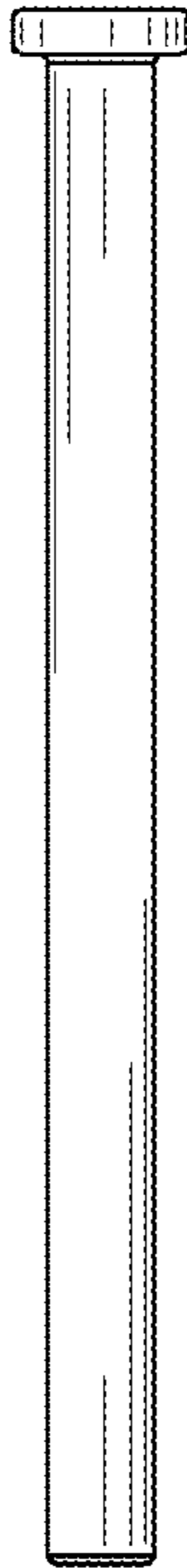

FIG. 10

FIG. 11

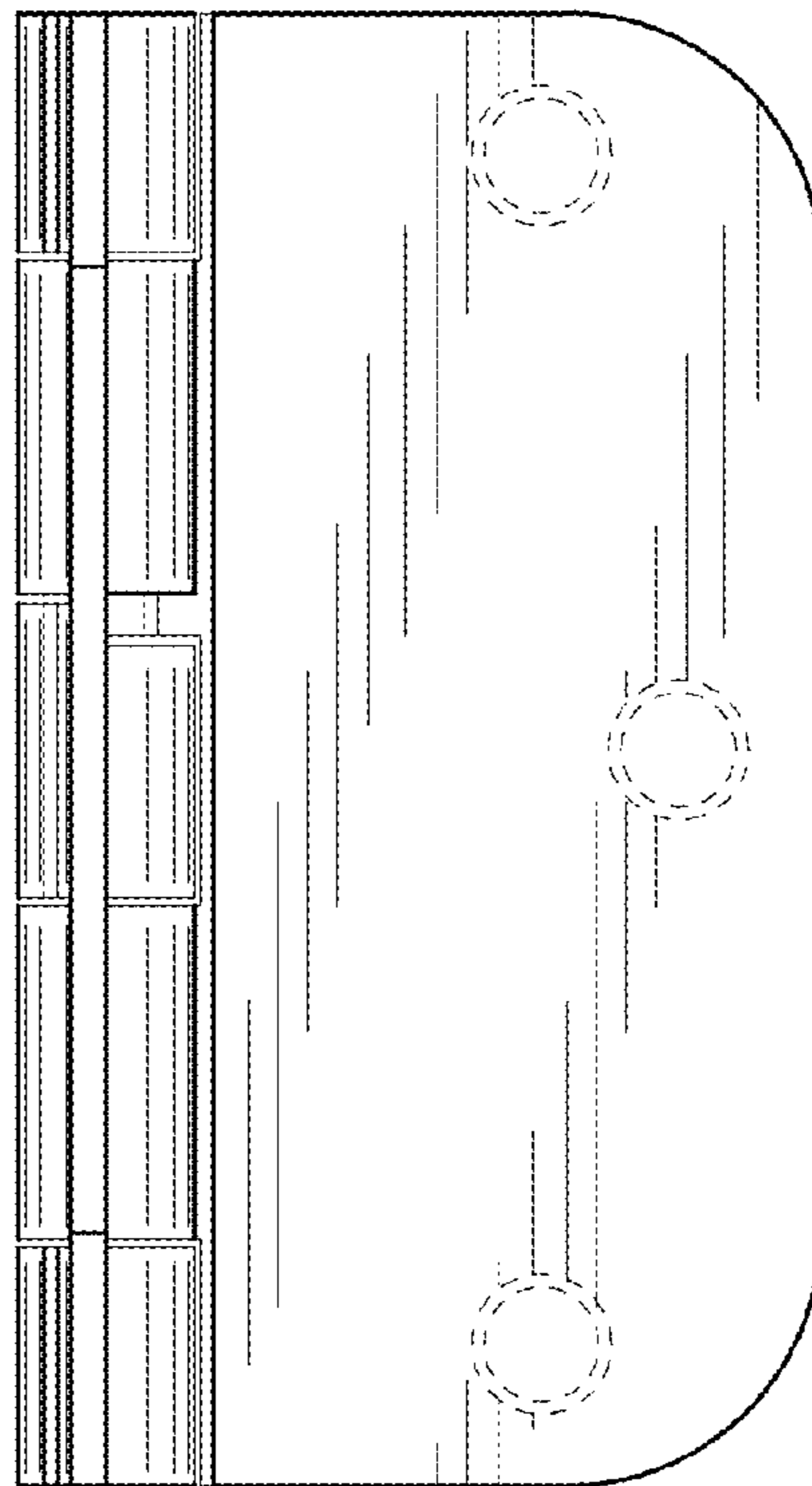
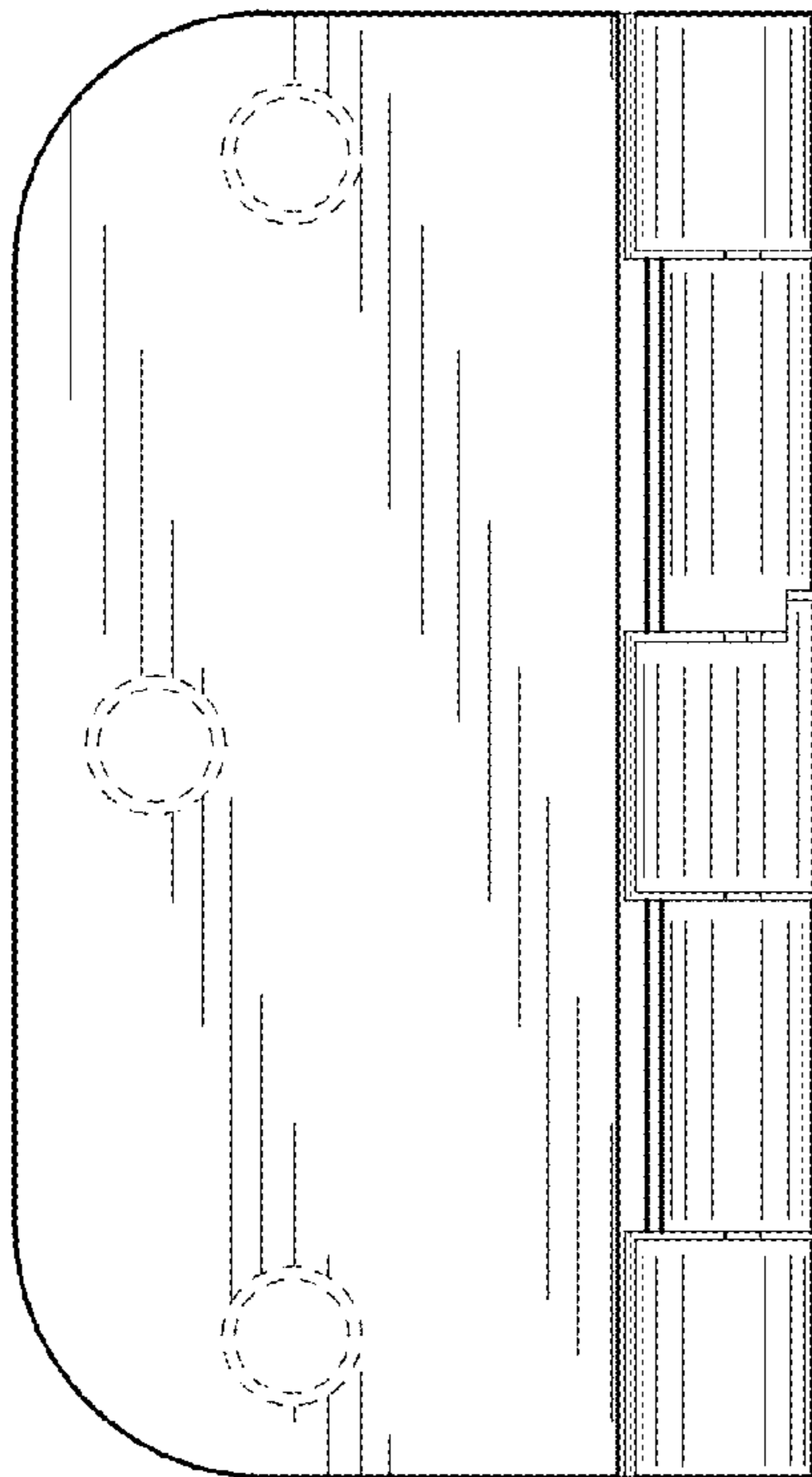
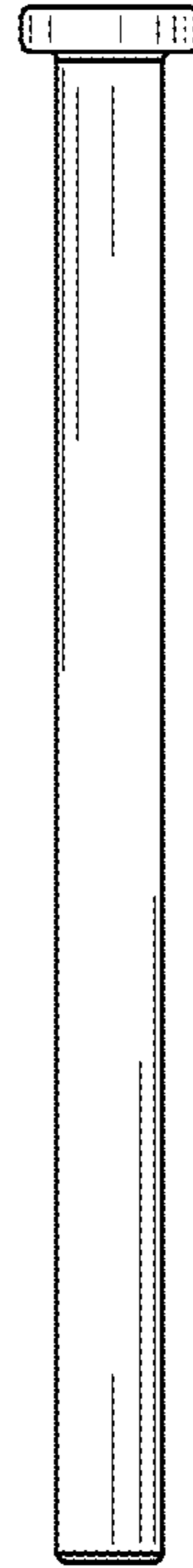
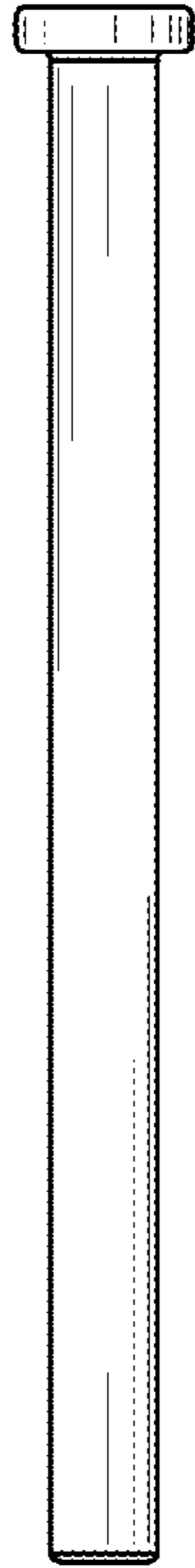

FIG. 12

FIG. 13

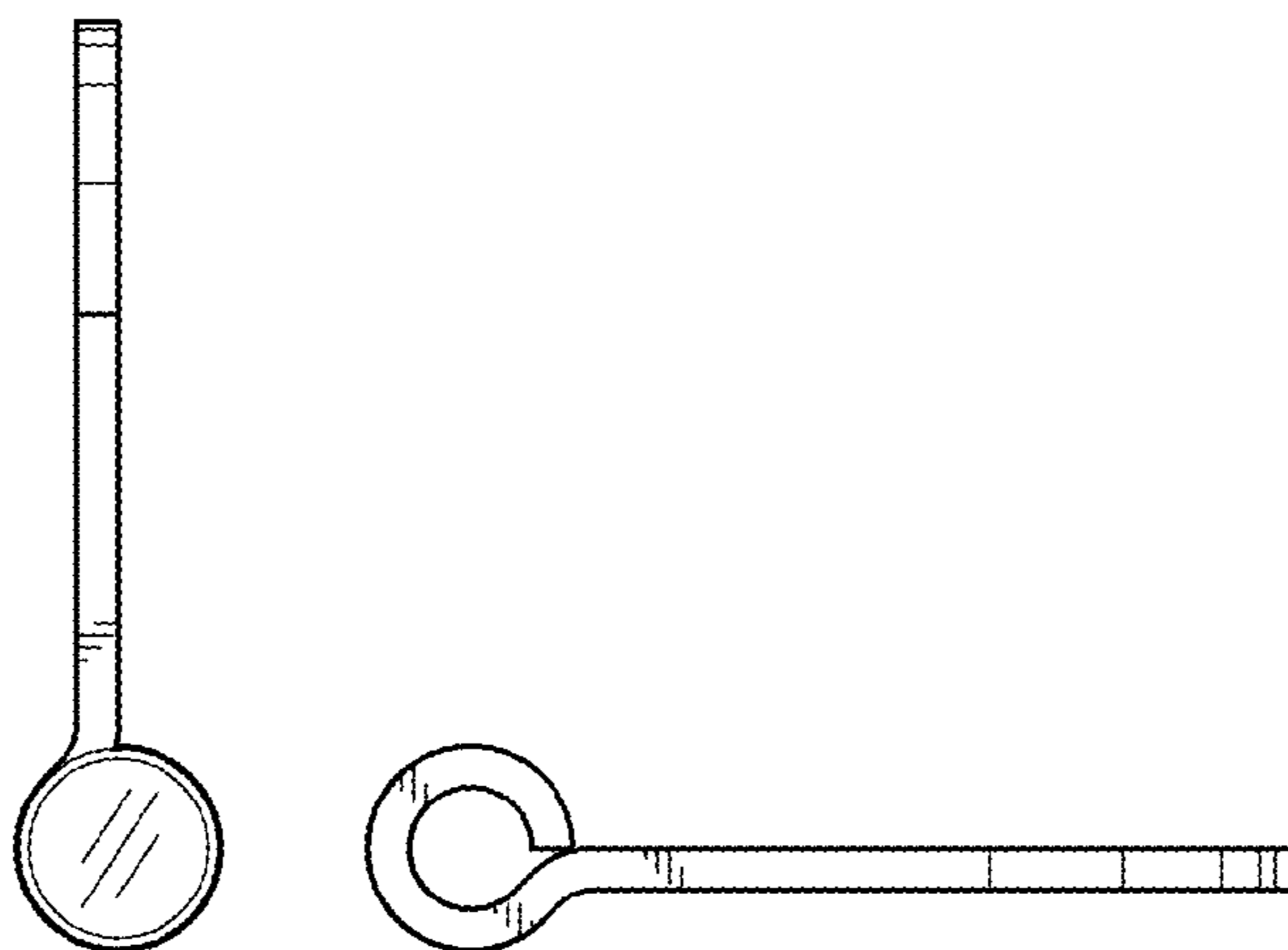

FIG. 14

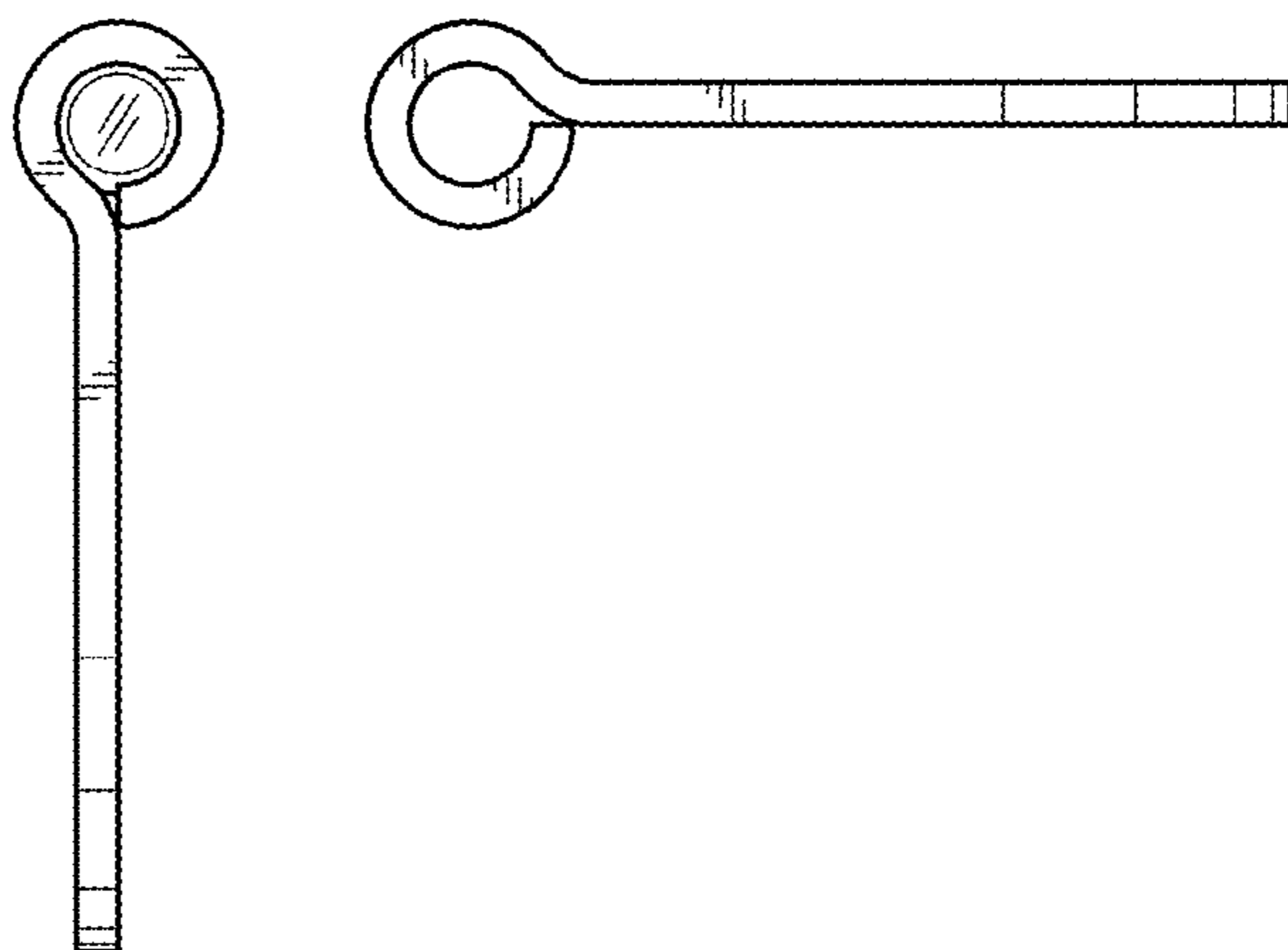

FIG. 15

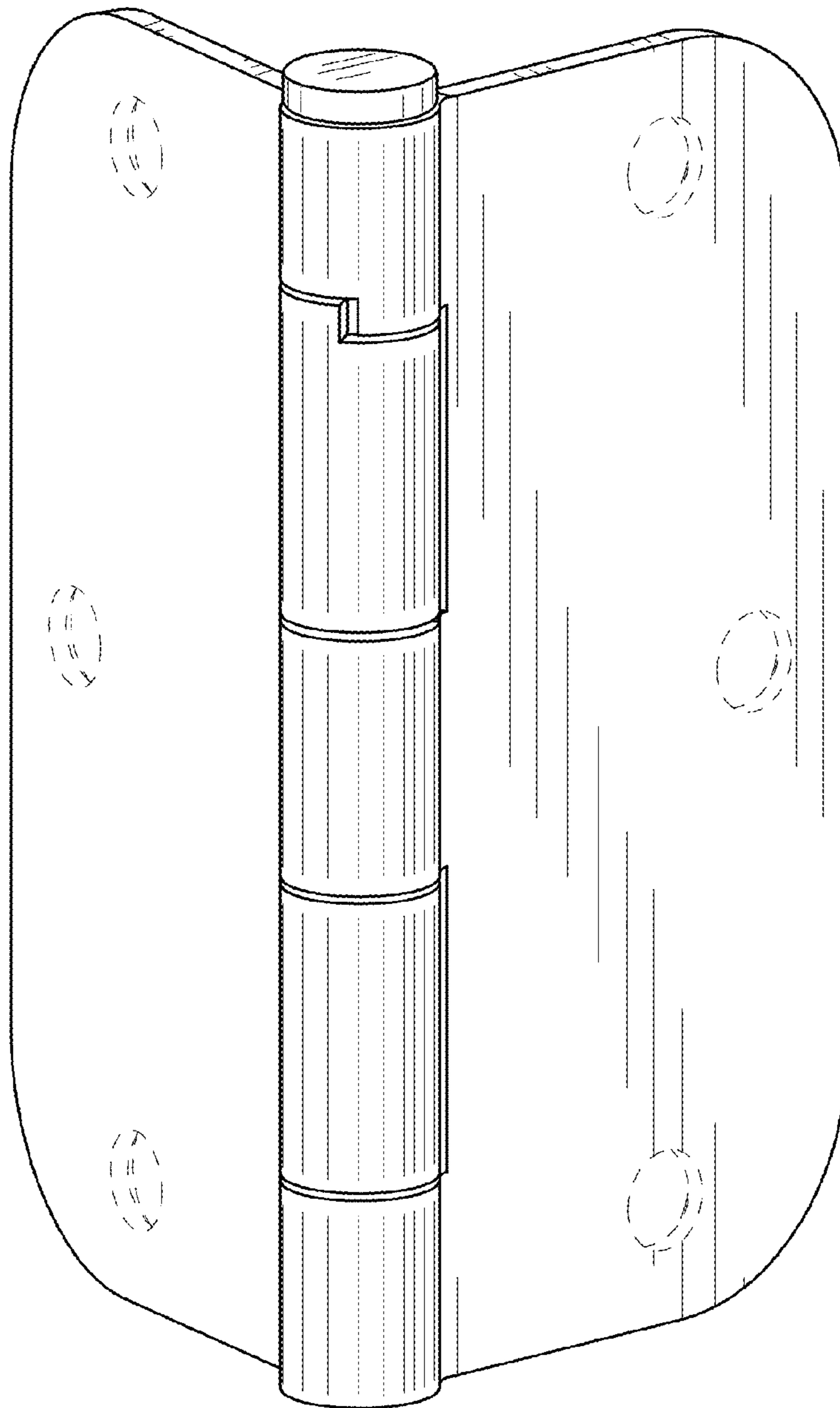

FIG. 16

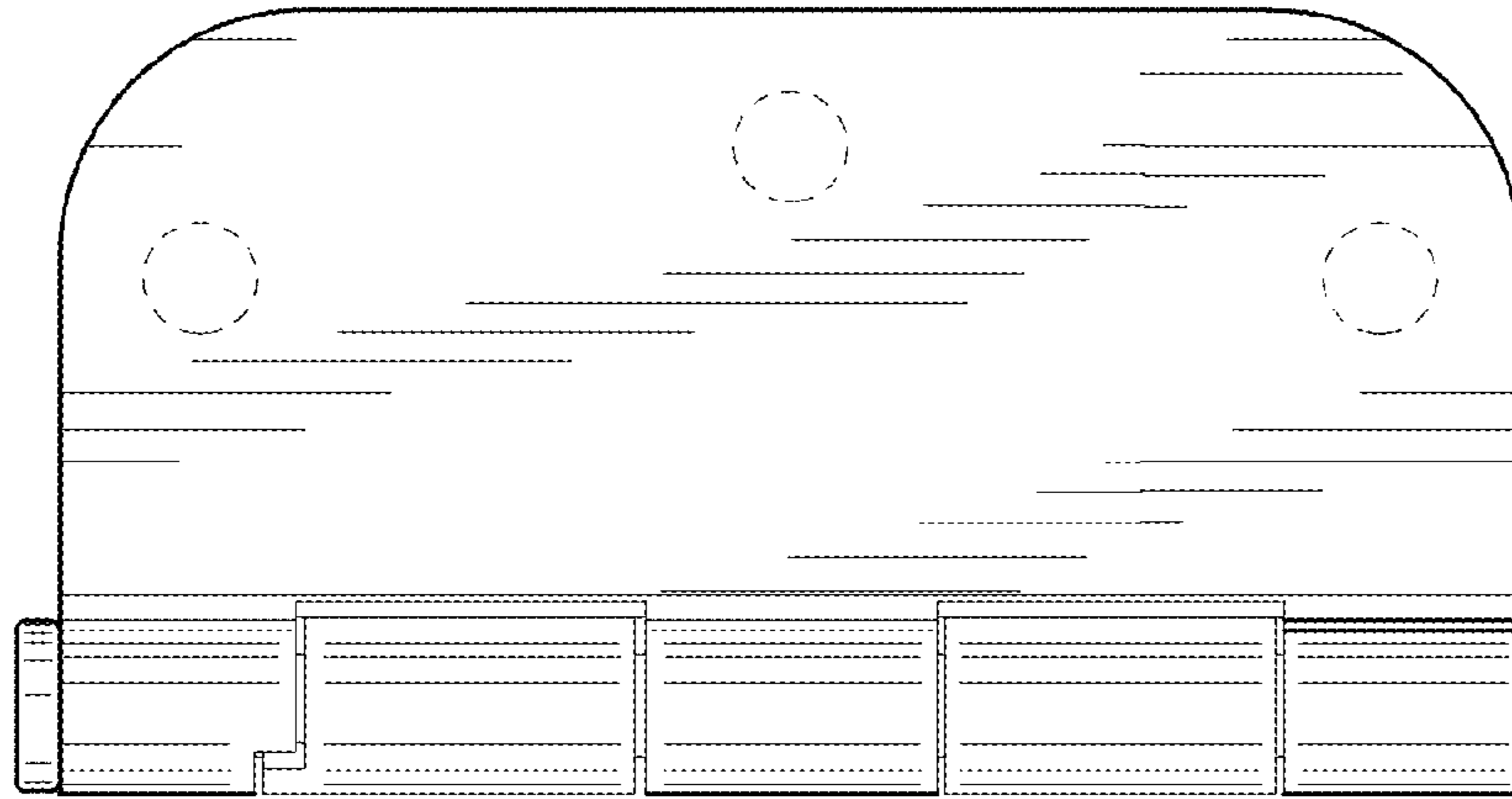

FIG. 18

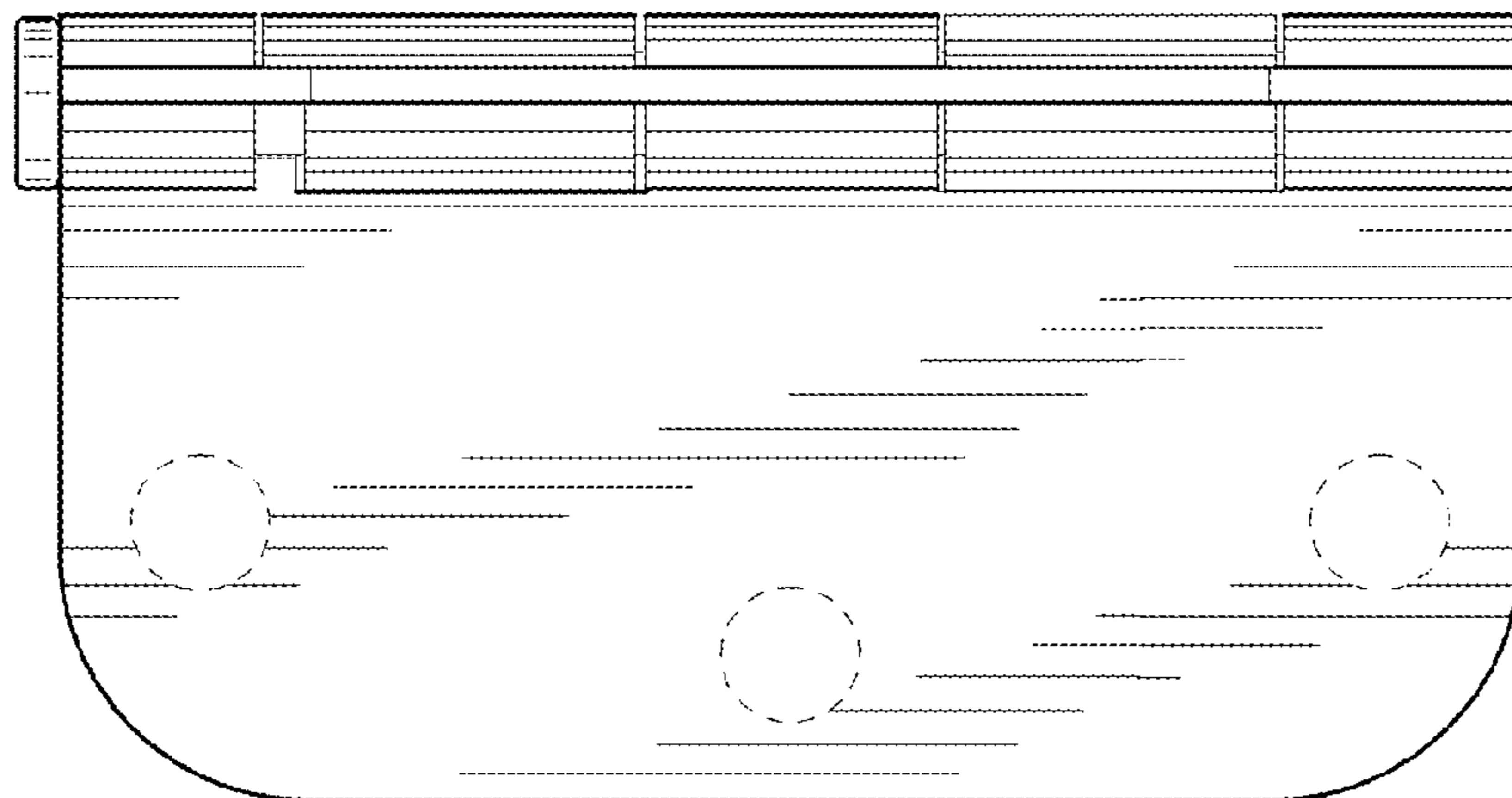

FIG. 17

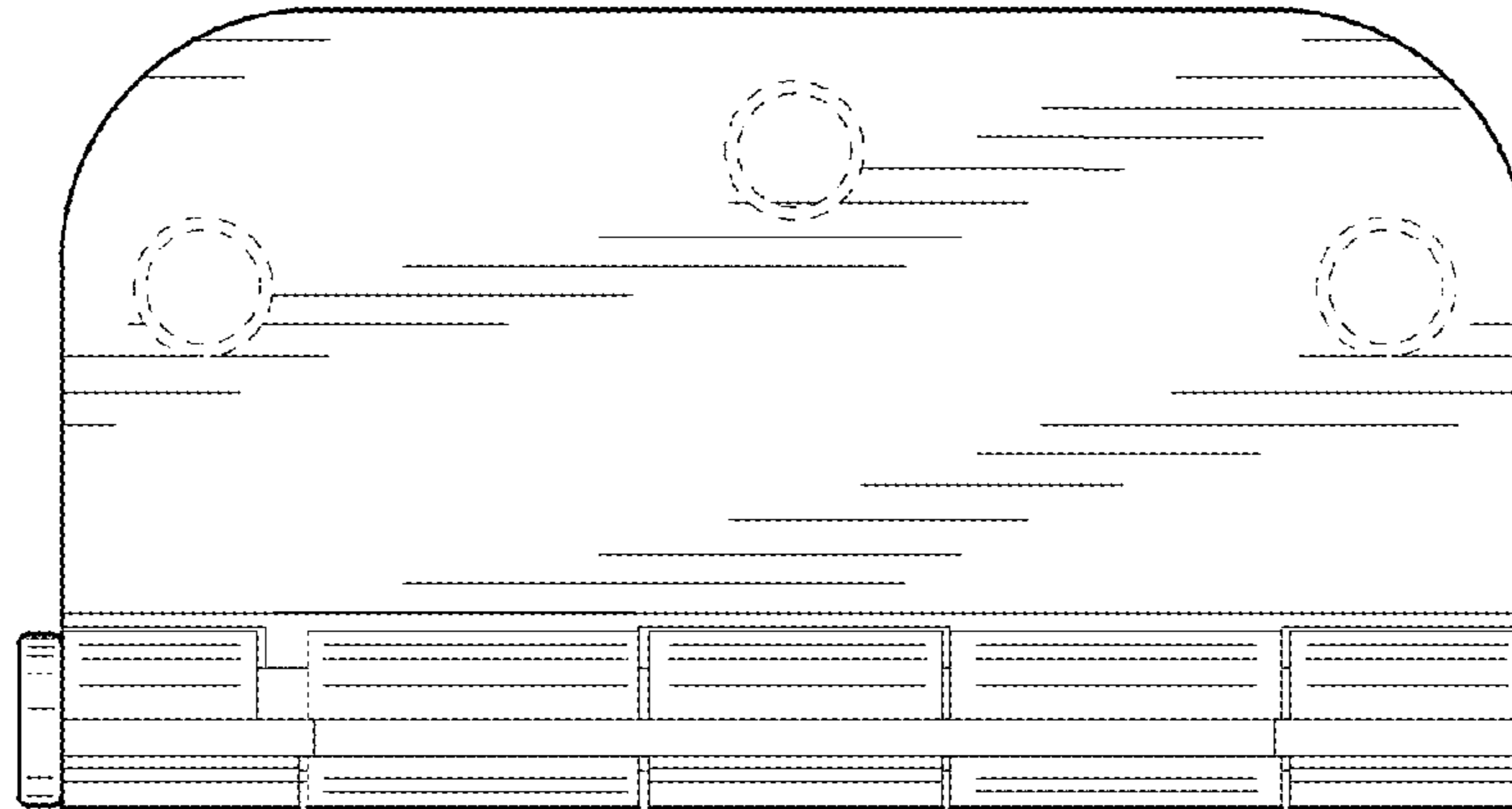

FIG. 20

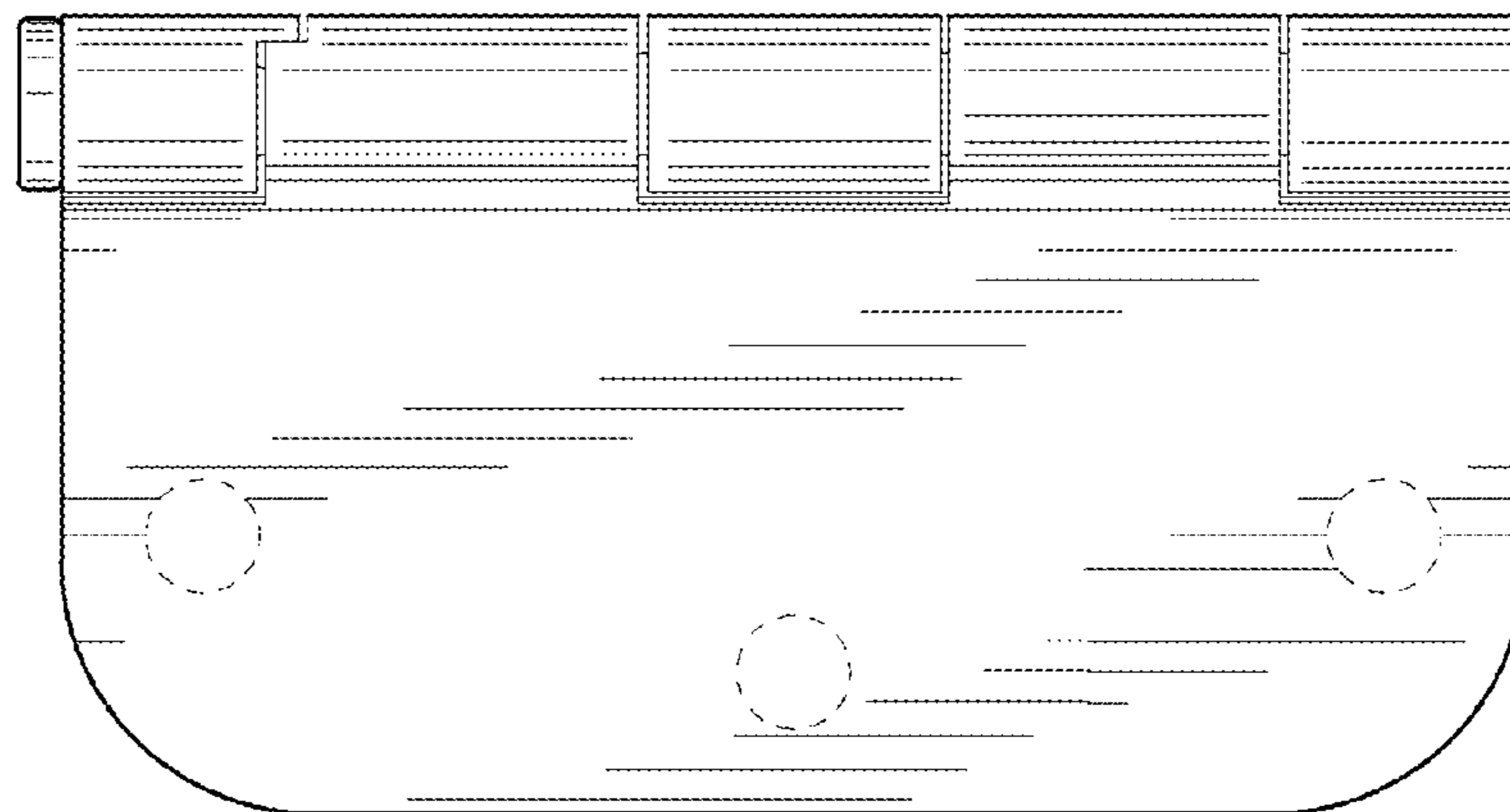

FIG. 19

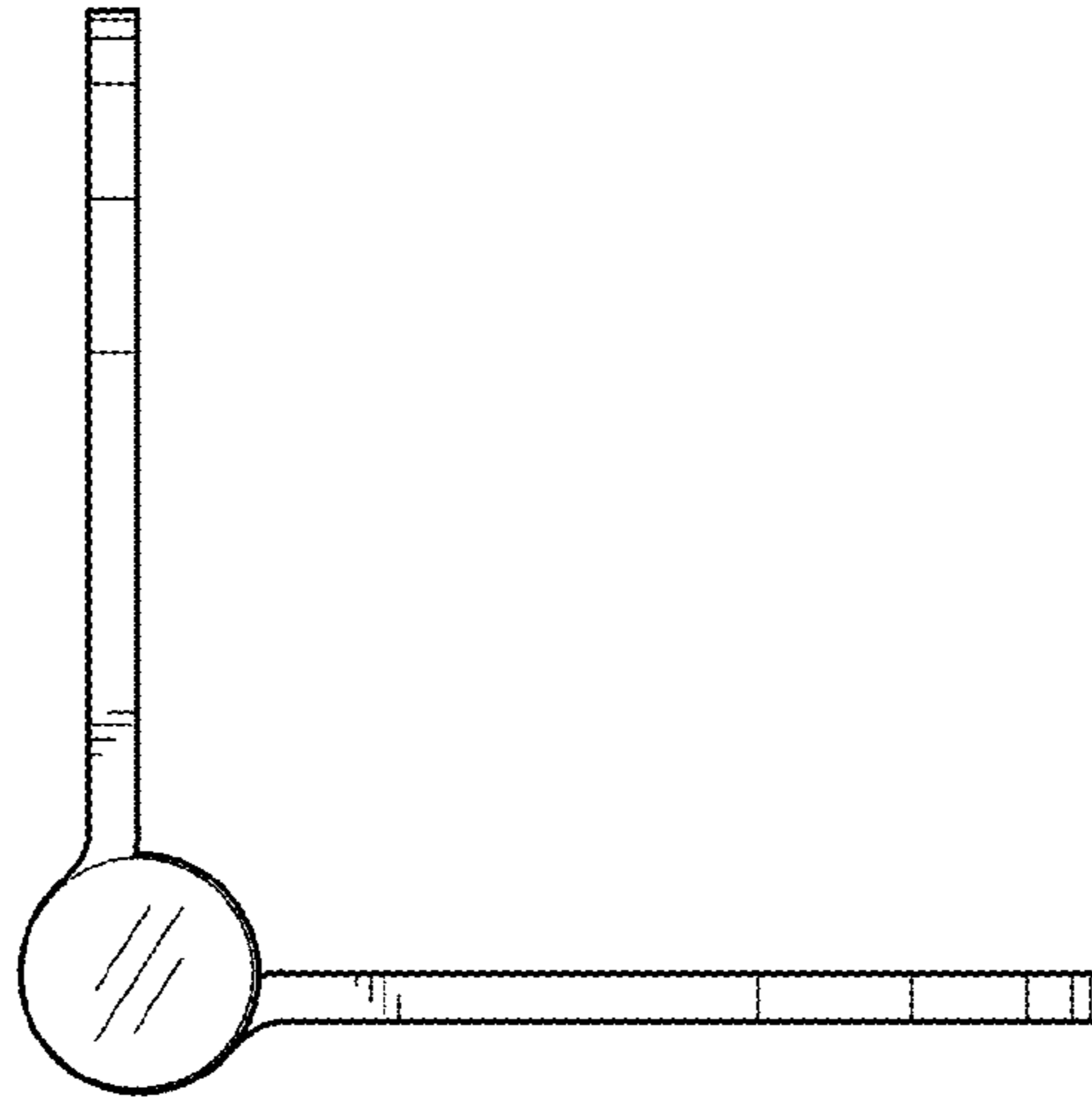

FIG. 21

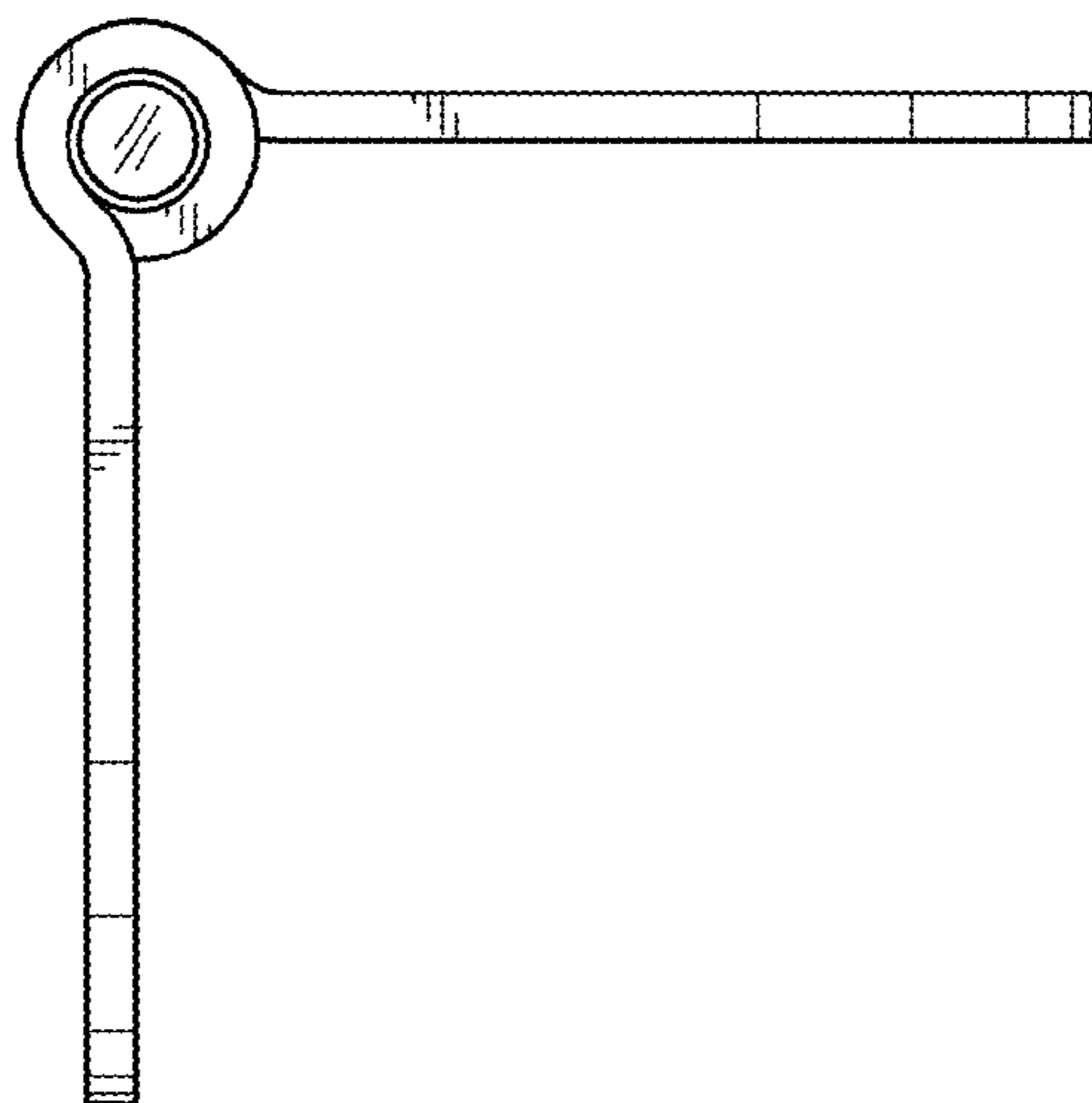

FIG. 22

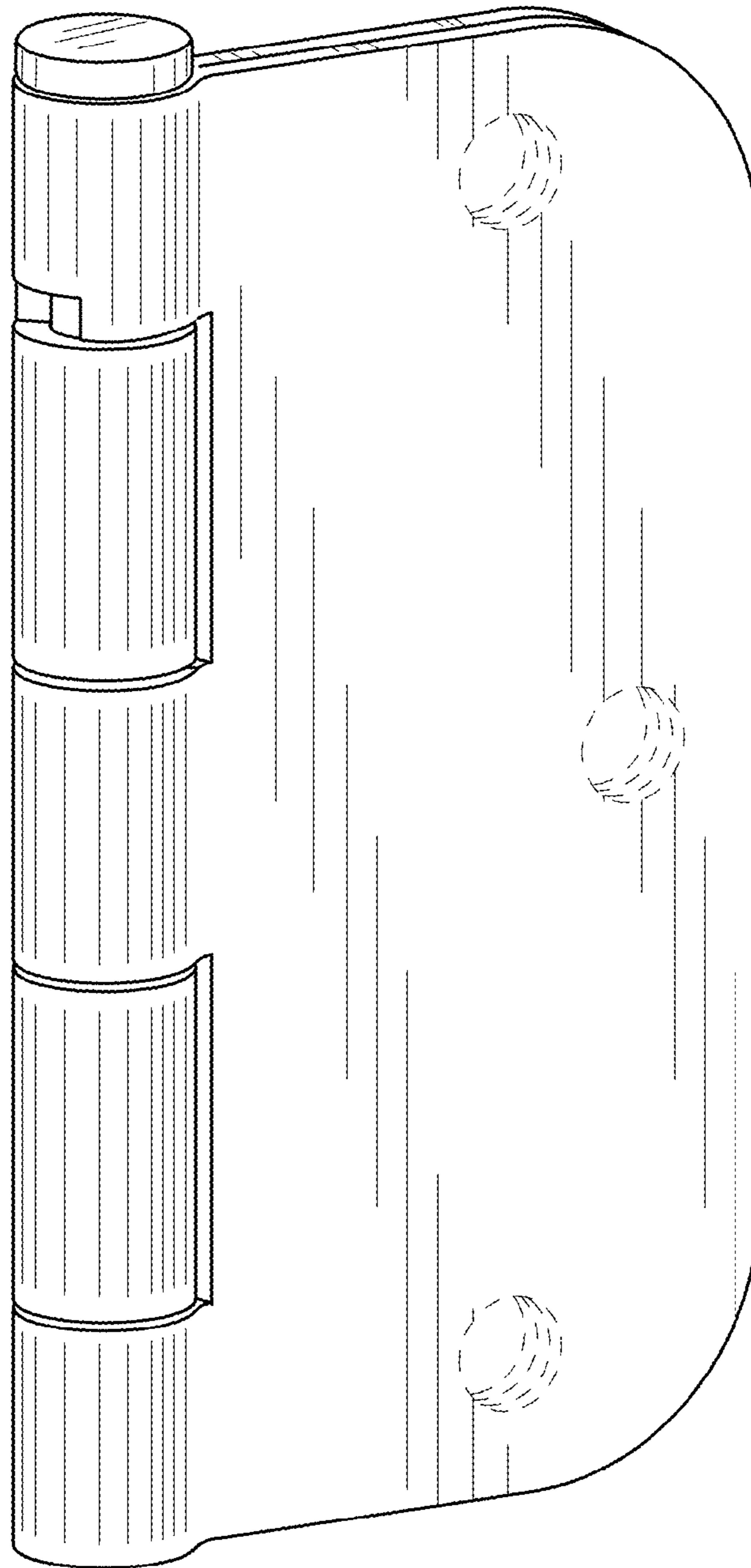

FIG. 23

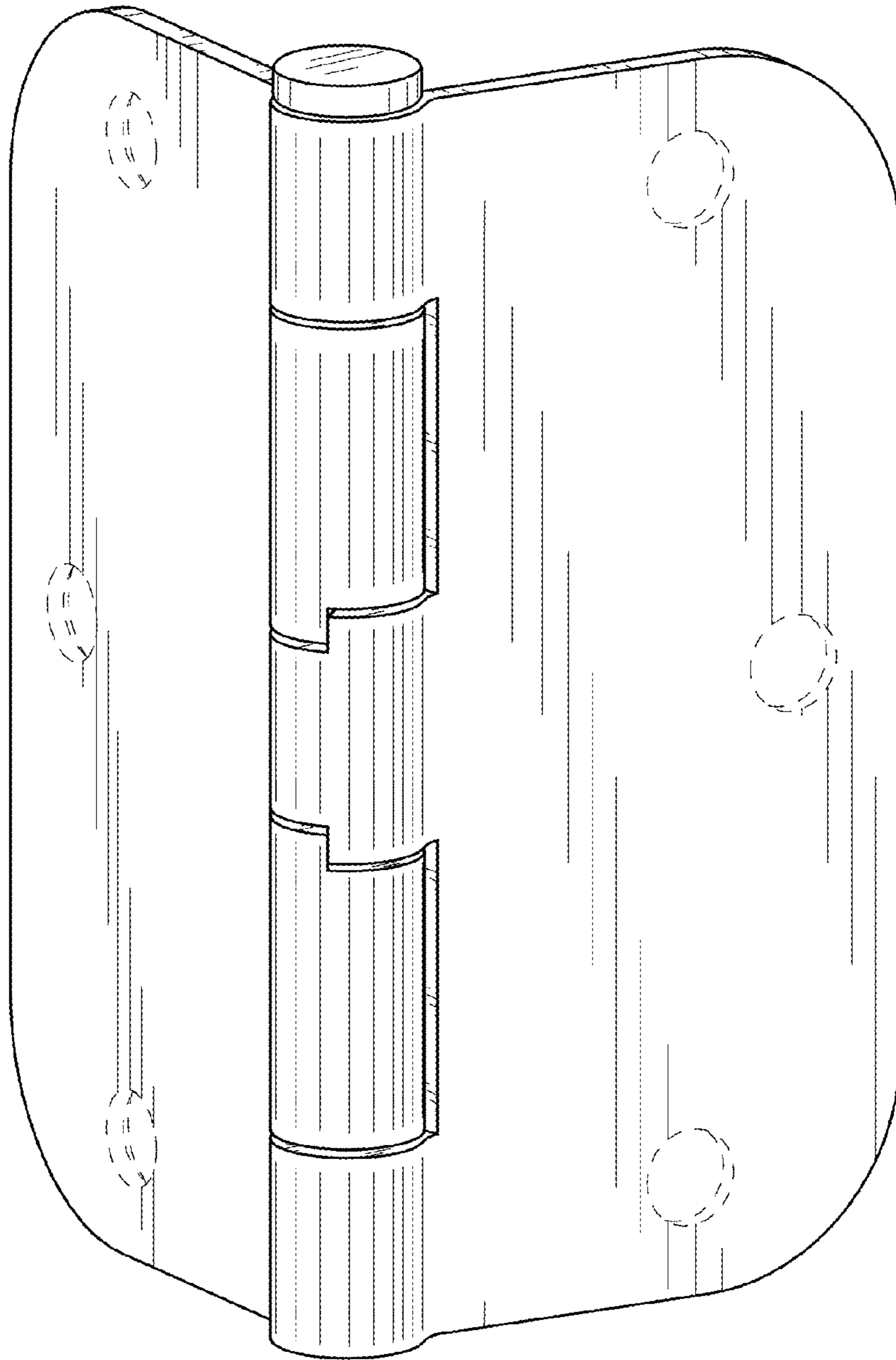

FIG. 24

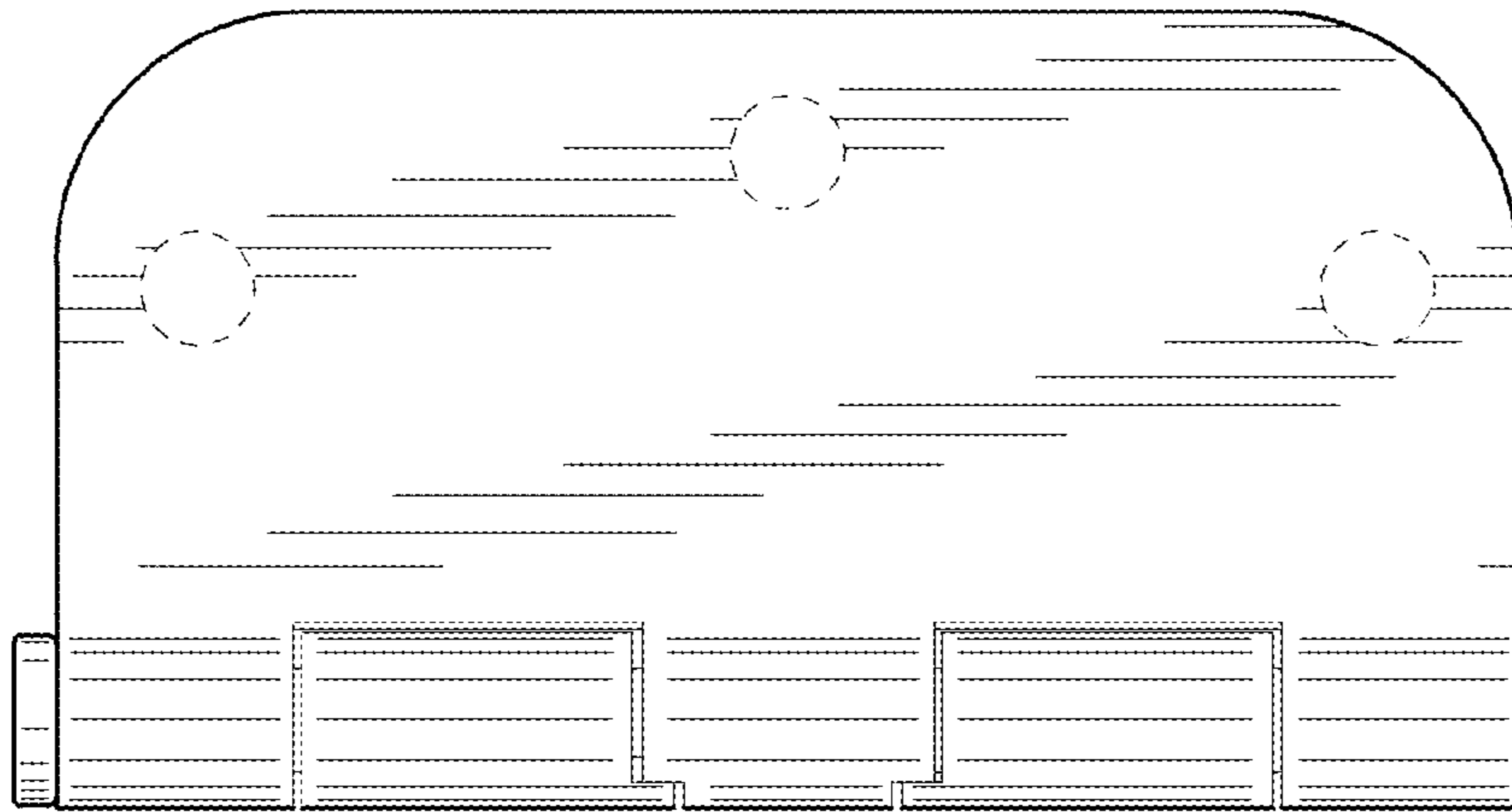

FIG. 26

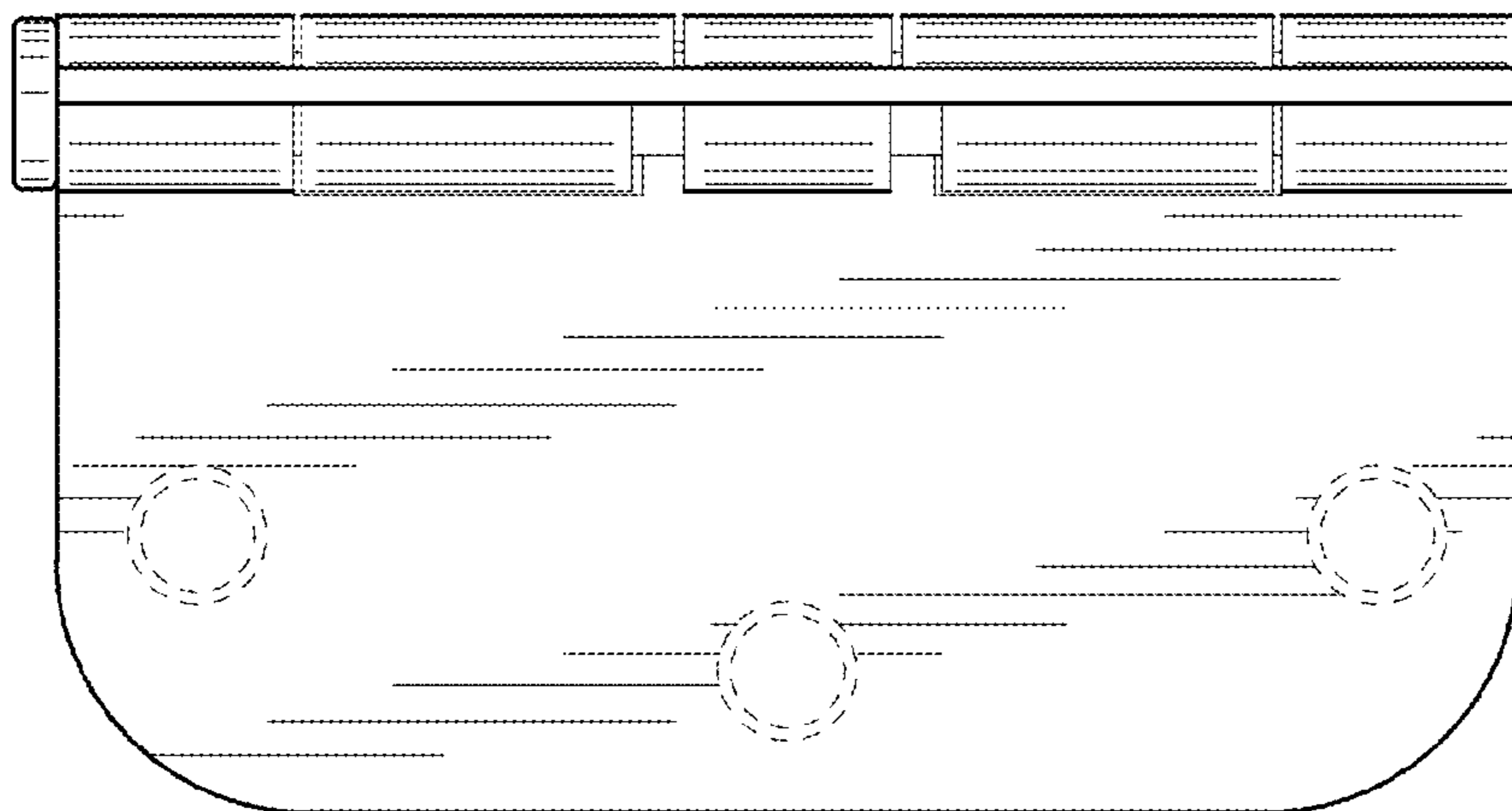

FIG. 25

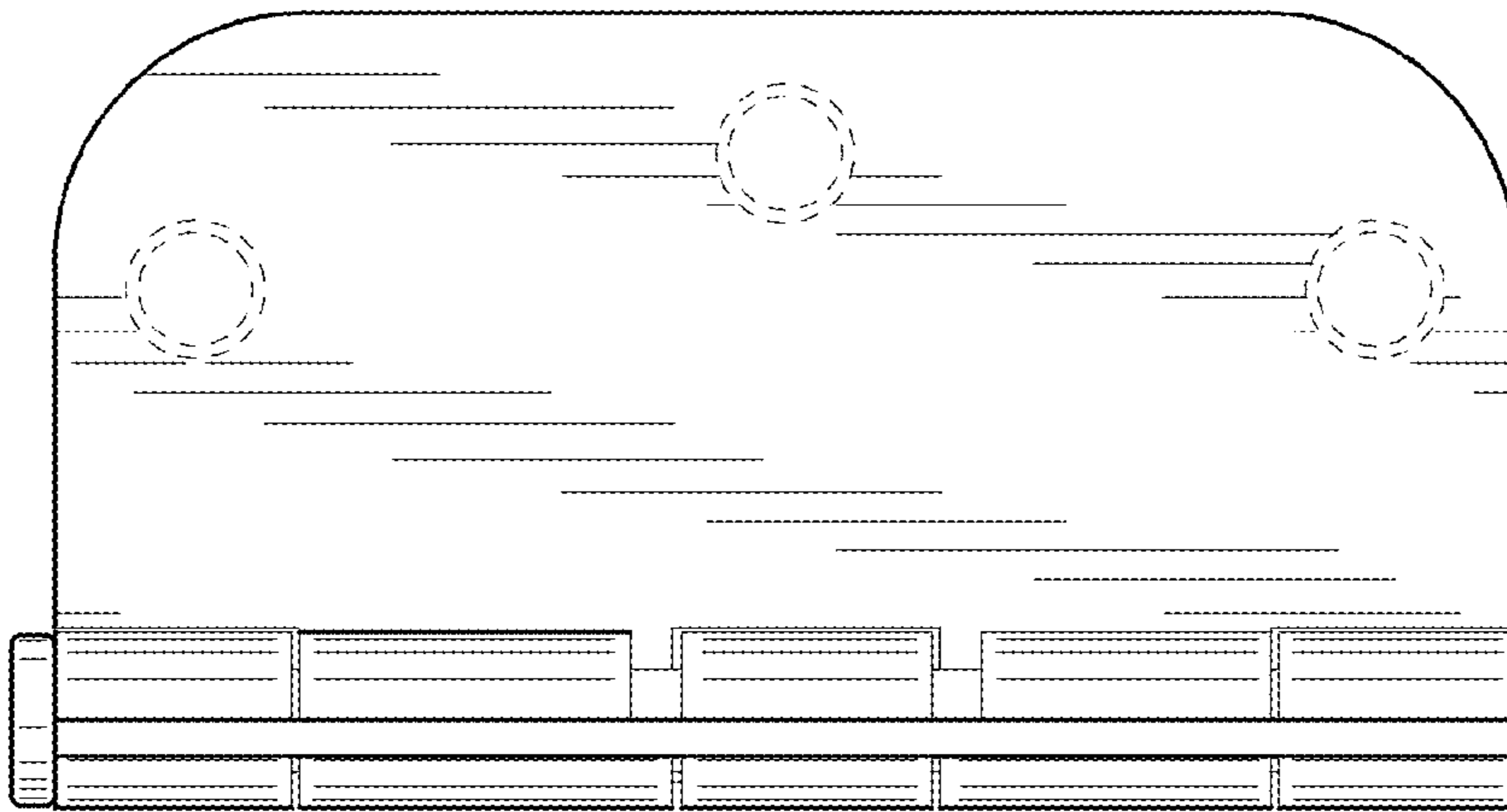

FIG. 28

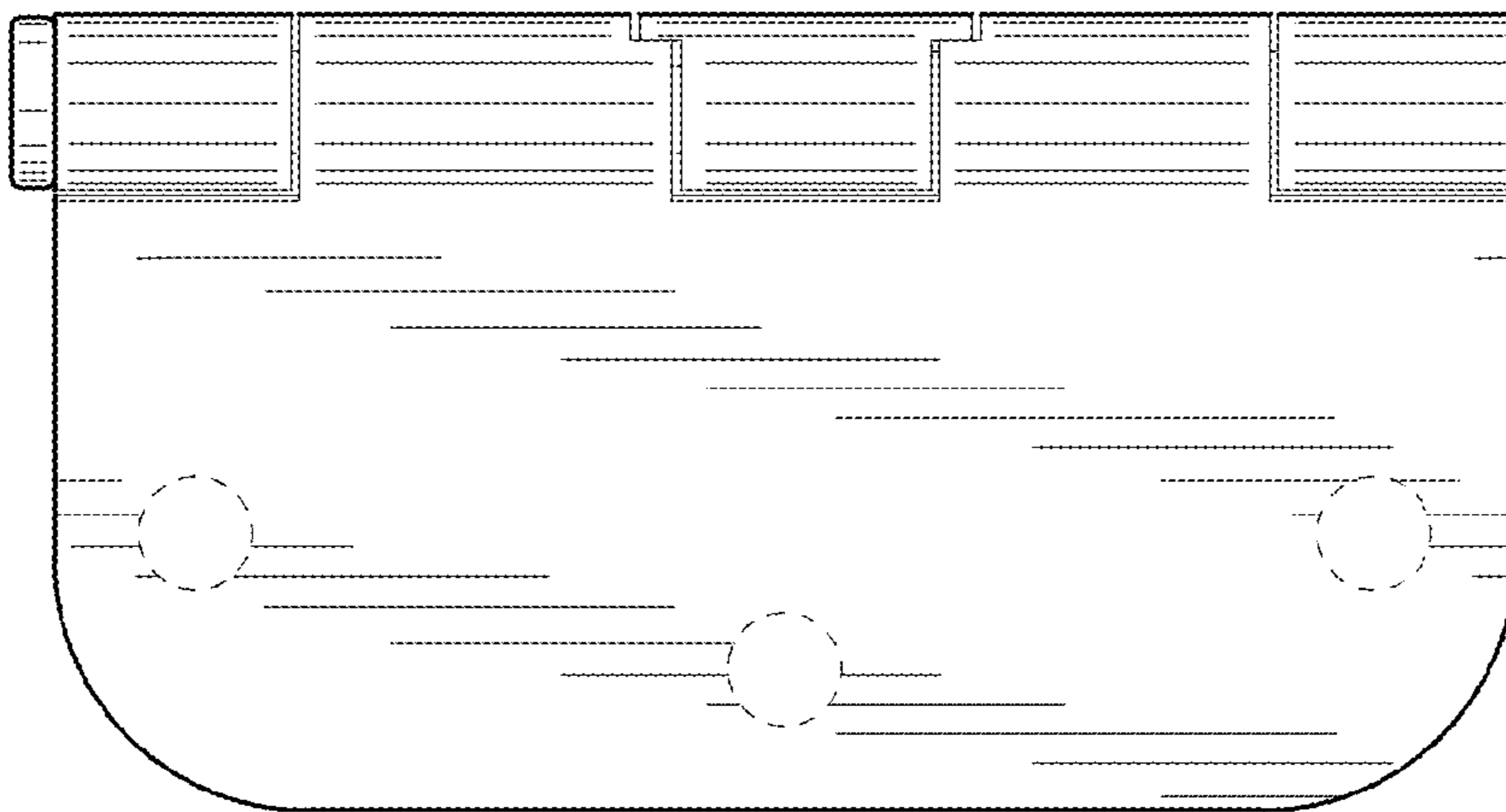

FIG. 27

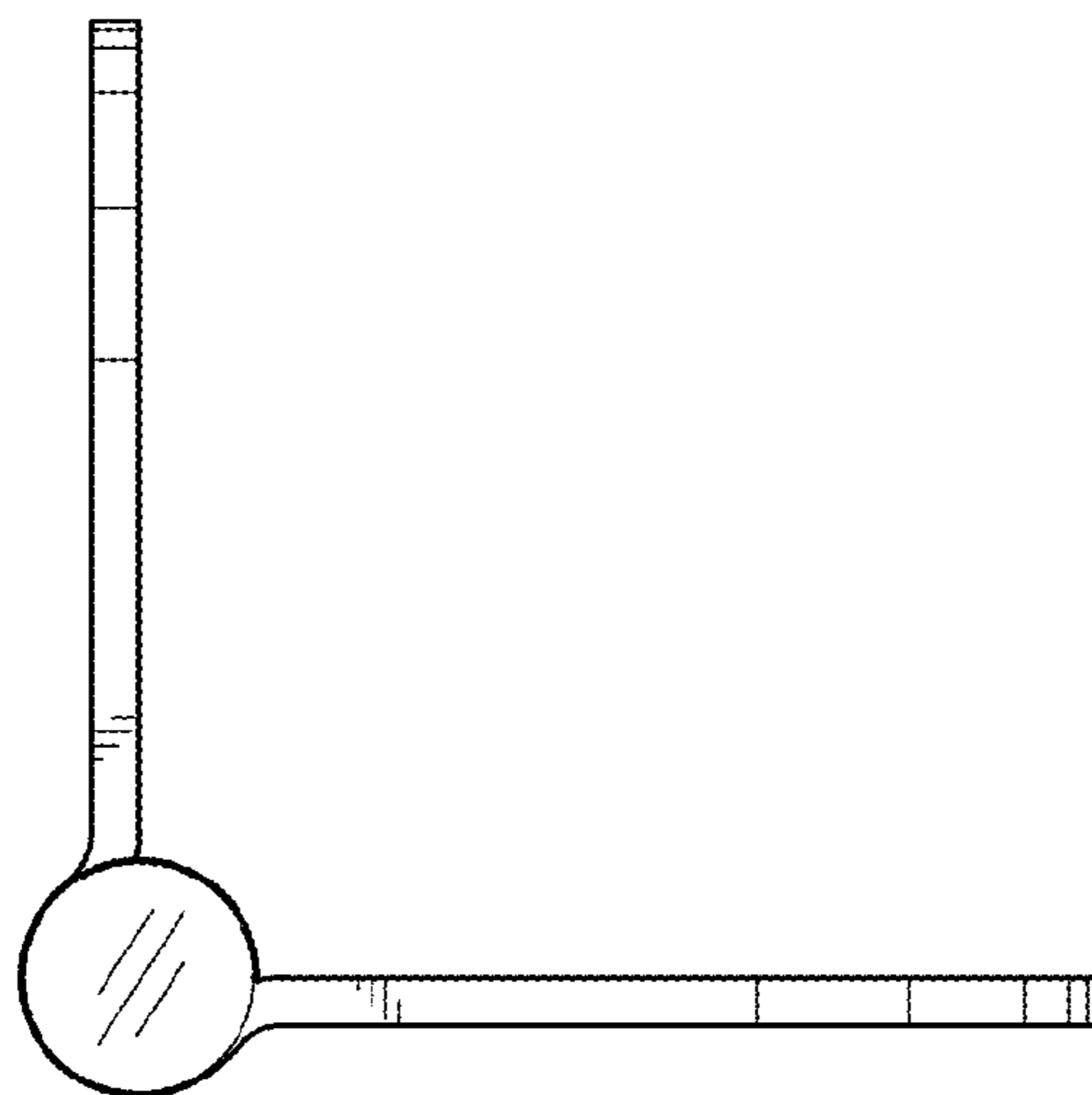

FIG. 29

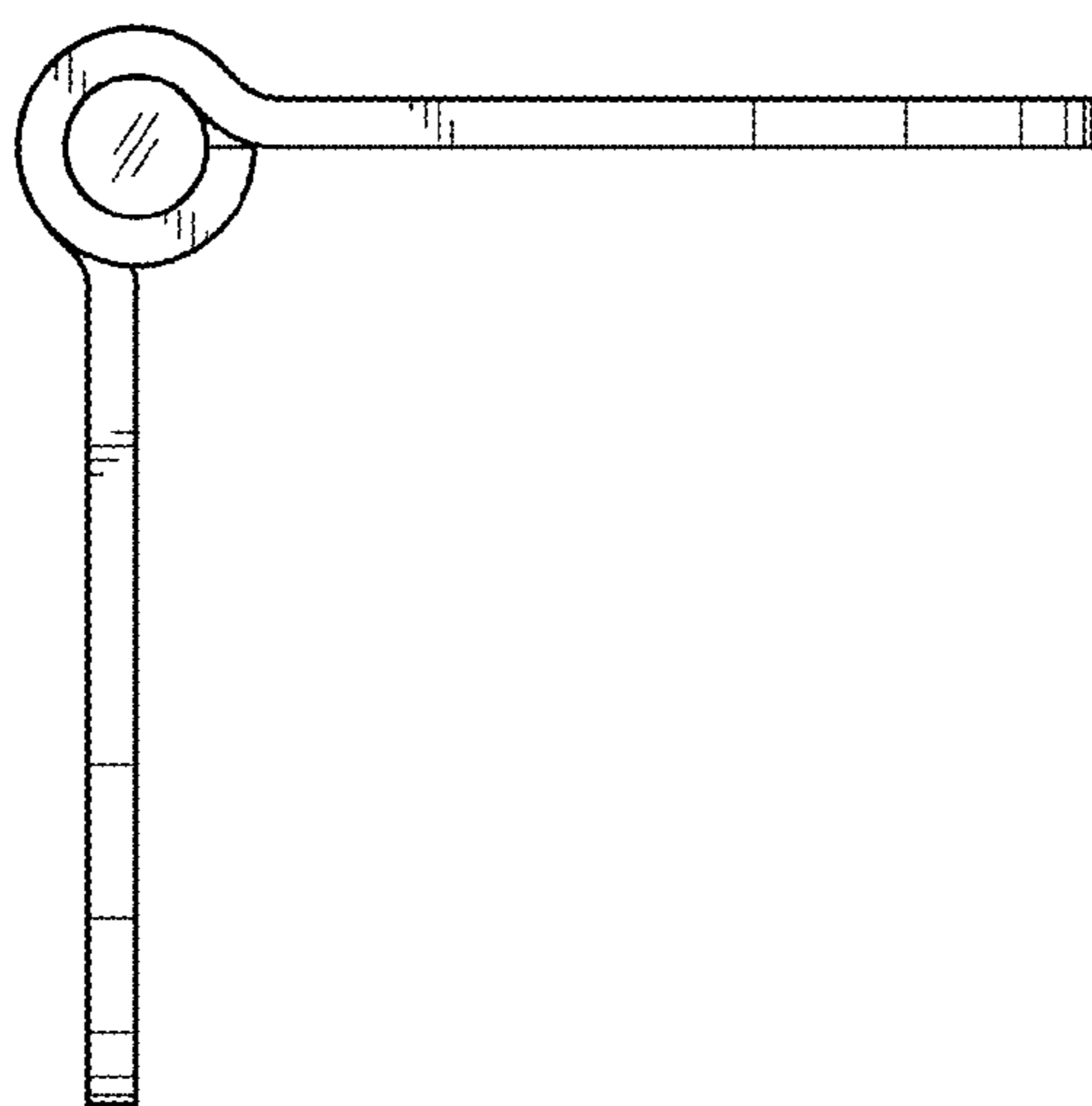

FIG. 30

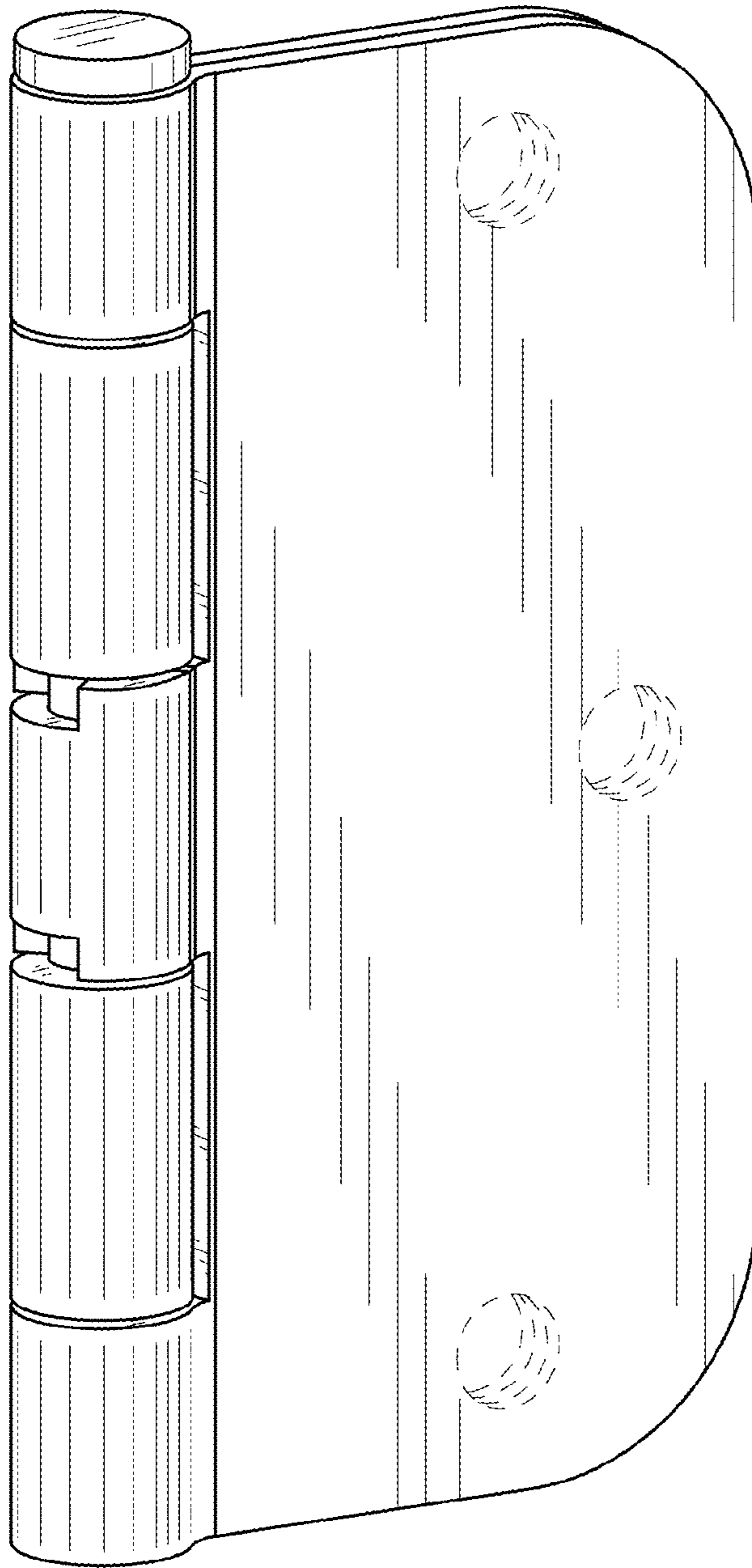

FIG. 31