



US00D710166S

(12) **United States Design Patent**
Cook

(10) **Patent No.:** **US D710,166 S**
(45) **Date of Patent:** **** Aug. 5, 2014**

- (54) **FOLDING CHISEL**
- (71) Applicant: **Stanley Black & Decker Inc.**, New Britain, CT (US)
- (72) Inventor: **Vincent Cook**, Milford, CT (US)
- (73) Assignee: **Stanley Black & Decker Inc.**, New Britain, CT (US)
- (**) Term: **14 Years**
- (21) Appl. No.: **29/452,023**
- (22) Filed: **Apr. 11, 2013**
- (51) **LOC (10) Cl.** **08-05**
- (52) **U.S. Cl.**
USPC **D8/47**
- (58) **Field of Classification Search**
CPC B25D 3/00; B25D 2250/115; B25D 2250/051; B25G 3/26; B25G 3/38; B27G 17/08; D28D 1/26
USPC D8/14, 45, 47, 88-89, 99, 105, 107; D22/117; 30/167, 153, 342
See application file for complete search history.

D566,222	S	*	4/2008	Hawk et al.	D22/118
D596,472	S	*	7/2009	Cook	D8/47
D604,765	S	*	11/2009	Glesser et al.	D19/41
2008/0189957	A1	*	8/2008	Kasper	30/167
2010/0139101	A1	*	6/2010	Cooper	30/153
2011/0041346	A1	*	2/2011	Chen	30/167
2013/0180114	A1	*	7/2013	Brown et al.	30/153

OTHER PUBLICATIONS

Fast Cap Pocket Chisels & Tools. Downloaded from <http://toolguyd.com/fastcap-pocket-chisels-tools/> on Apr. 3, 2014.*
Fat Max Pocket Chisel. Snagged Apr. 3, 2014 at <http://toolguyd.com/stanley-fatmax-pocket-chisel/>.*

* cited by examiner

Primary Examiner — Philip S Hyder
Assistant Examiner — Roselynn Cody
(74) *Attorney, Agent, or Firm* — Gabriel Haboubi

(57) **CLAIM**

The ornamental design for a folding chisel, as shown and described.

DESCRIPTION

FIG. 1 is a top perspective view of a folding chisel showing my new design;
FIG. 2 is a top view thereof
FIG. 3 is a bottom view thereof;
FIG. 4 is a right view thereof;
FIG. 5 is a left view thereof;
FIG. 6 is a rear plan thereof;
FIG. 7 is a front plan view;
FIG. 8 is a top perspective view of the chisel folded;
FIG. 9 is a top view thereof
FIG. 10 is a bottom view thereof;
FIG. 11 is a right view thereof;
FIG. 12 is a left view thereof;
FIG. 13 is a rear plan thereof; and,
FIG. 14 is a front plan view.

1 Claim, 8 Drawing Sheets

(56) **References Cited**

U.S. PATENT DOCUMENTS

229,706	A	*	7/1880	Jansen	30/153
881,294	A	*	3/1908	Billings	30/153
1,569,164	A	*	1/1926	Widmer	30/167
1,598,603	A	*	9/1926	Cook	76/119
1,604,007	A	*	10/1926	Wigren	279/99
D237,037	S	*	10/1975	Brunosson	D8/47
D368,634	S	*	4/1996	Frazer	D8/105
D401,133	S	*	11/1998	Gardiner et al.	D8/105
D403,569	S	*	1/1999	Frazer	D8/105
D487,494	S	*	3/2004	Glesser	D22/118
6,718,585	B2	*	4/2004	McIntosh et al.	7/128
D494,824	S	*	8/2004	Hernandez	D8/47
6,848,183	B2	*	2/2005	Lemisch	30/153
D560,994	S	*	2/2008	Green	D8/99

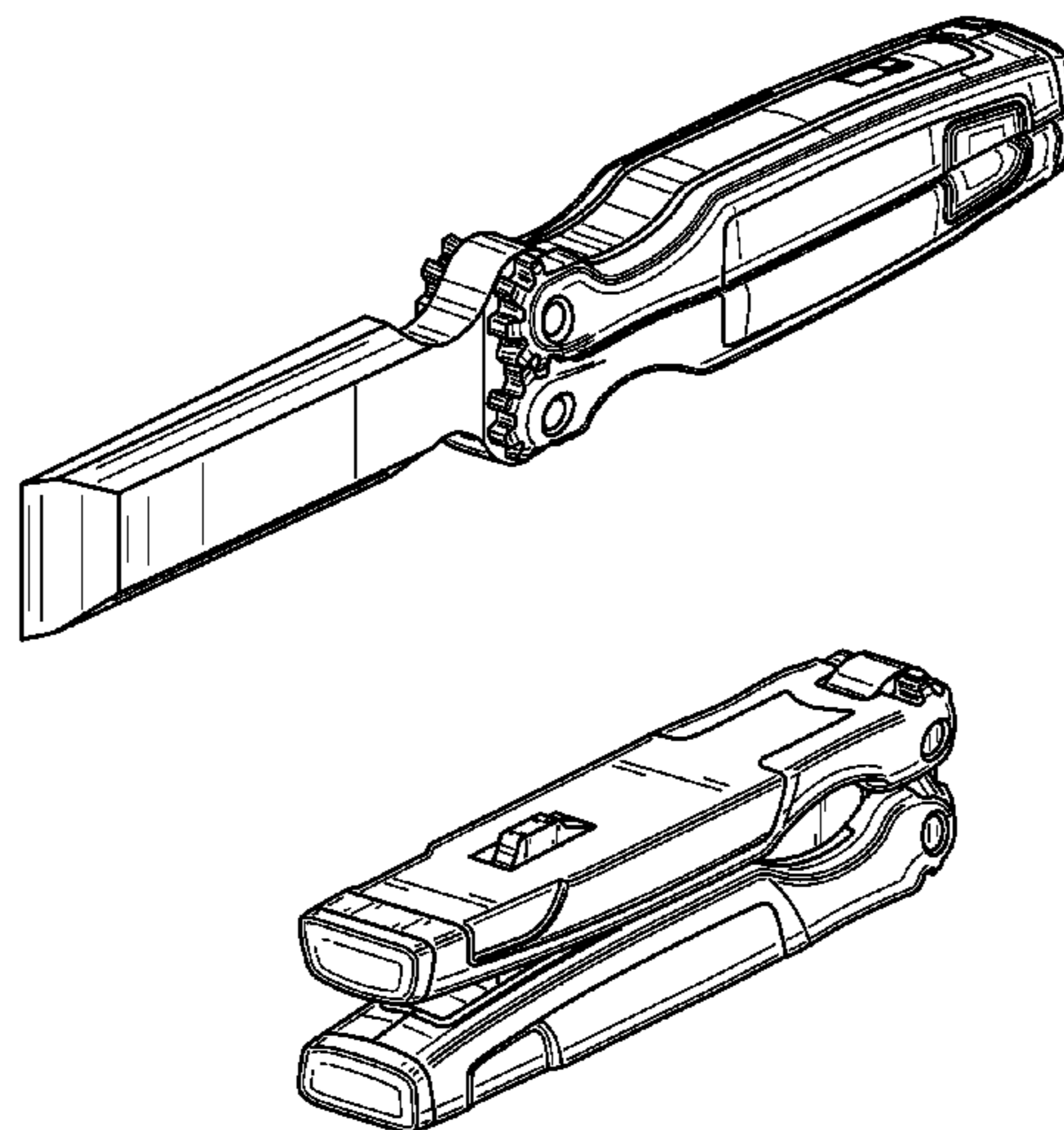

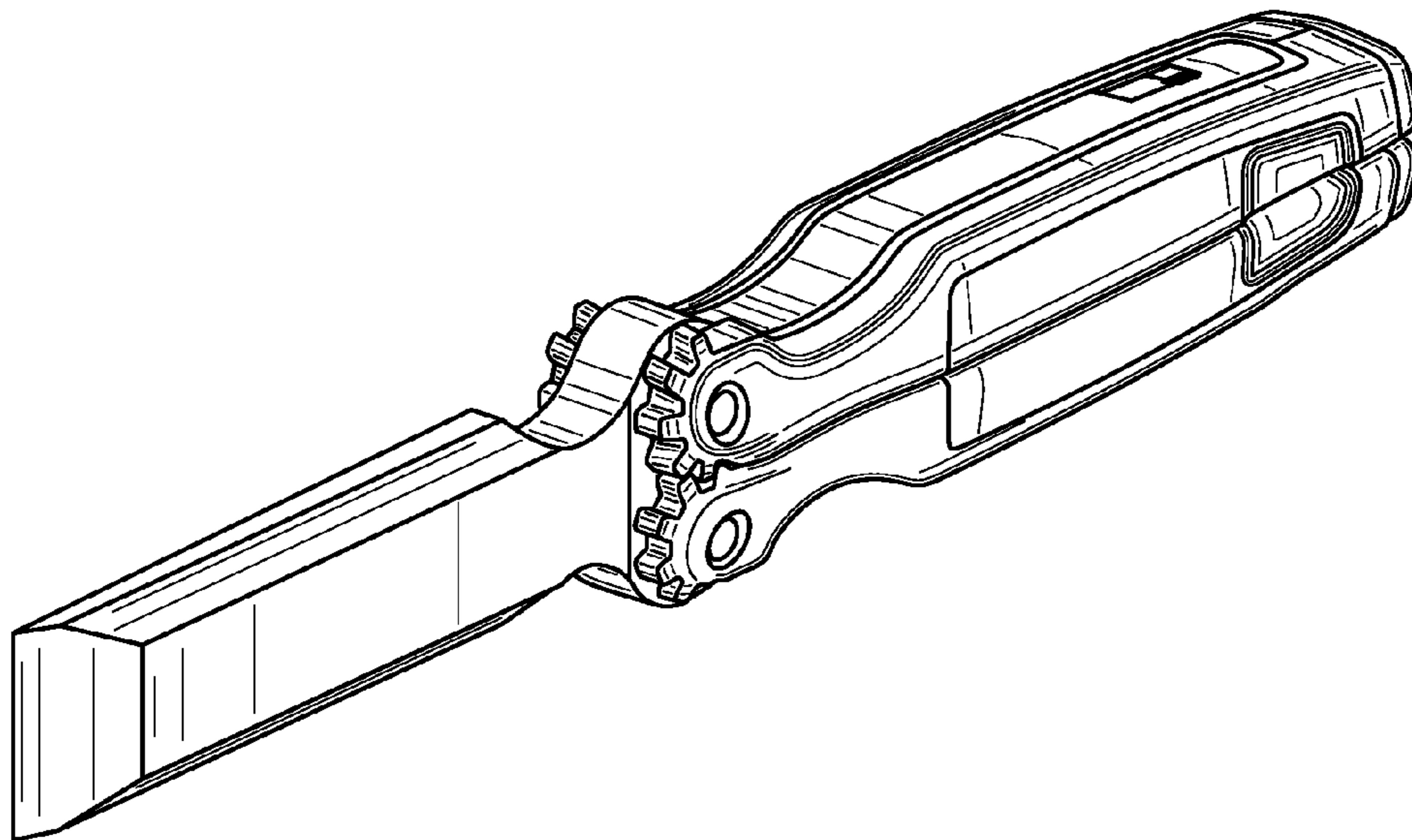

FIG. 1

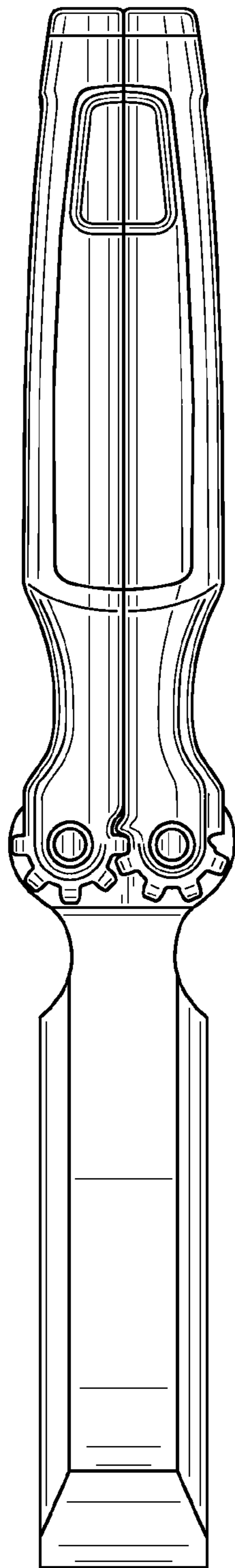

FIG. 2

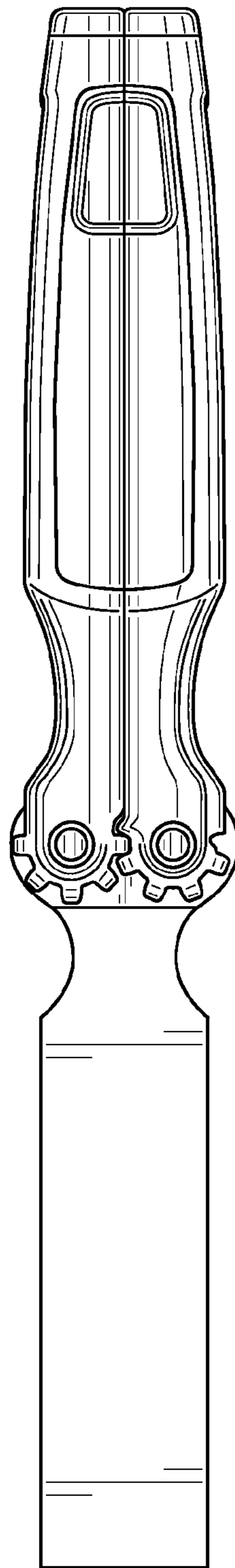

FIG. 3

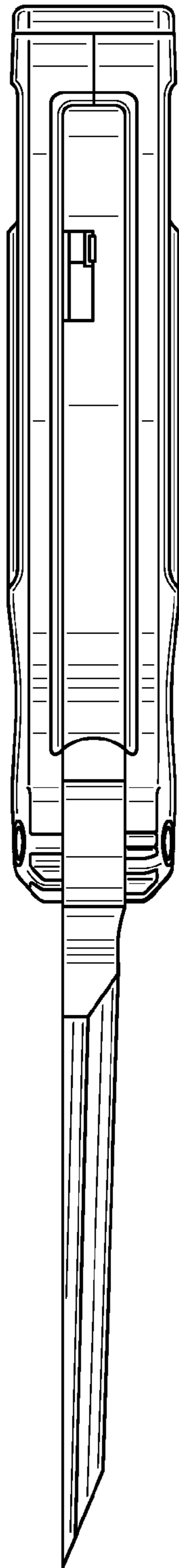

FIG. 4

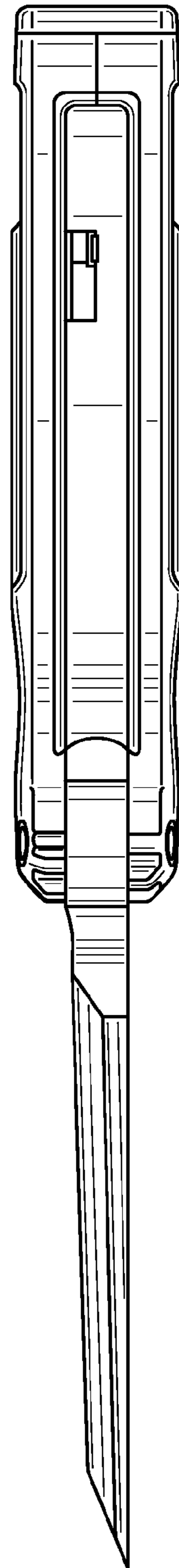

FIG. 5

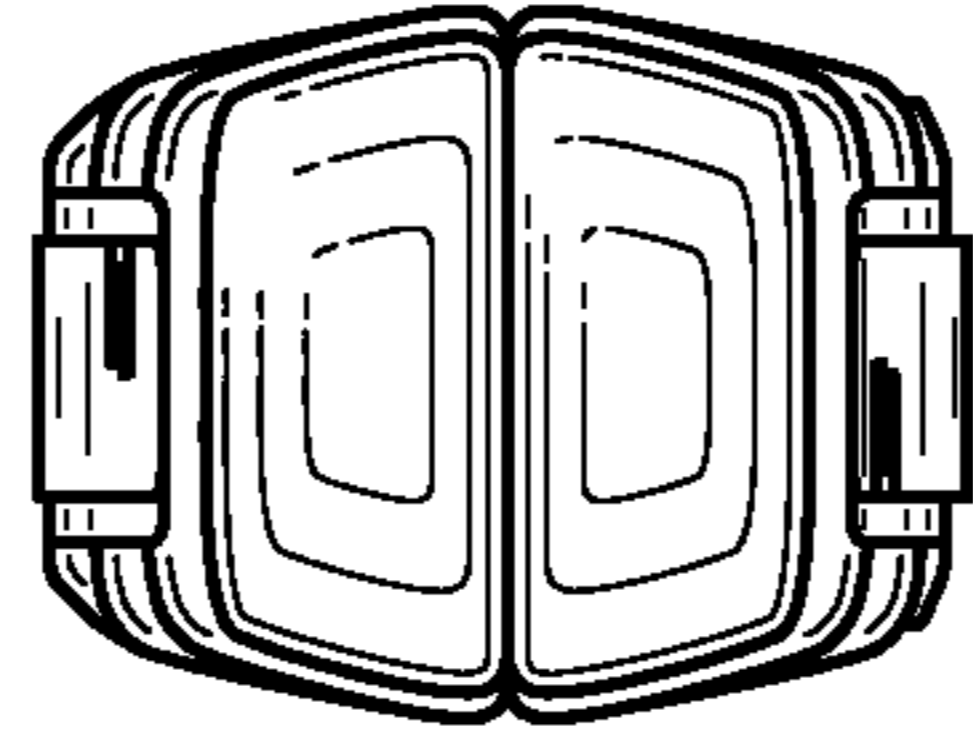

FIG. 6

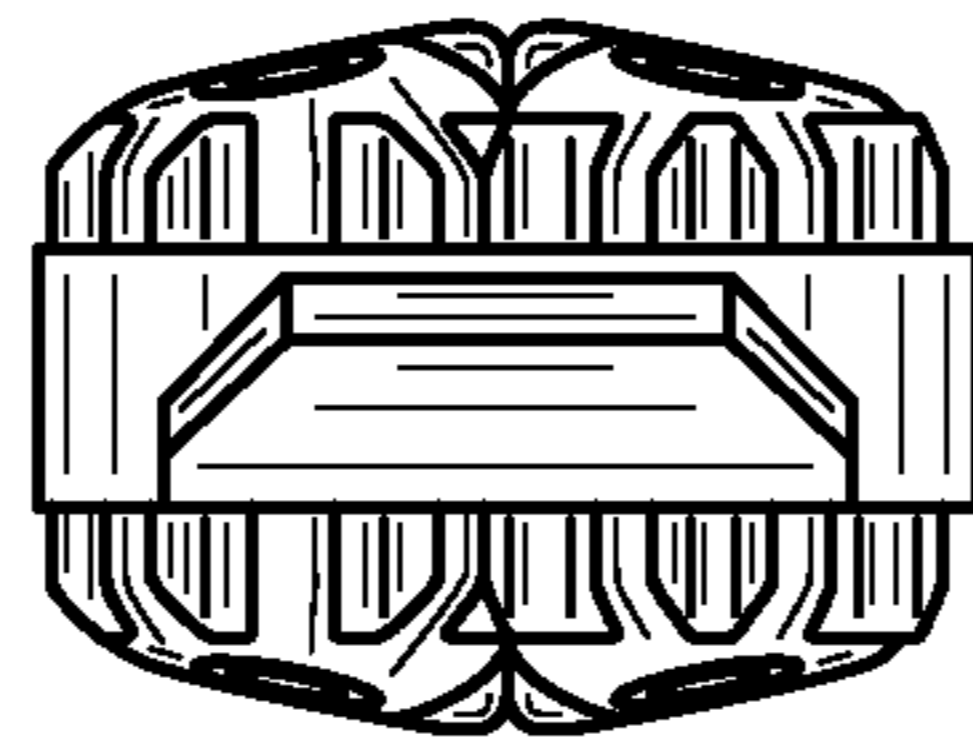

FIG. 7

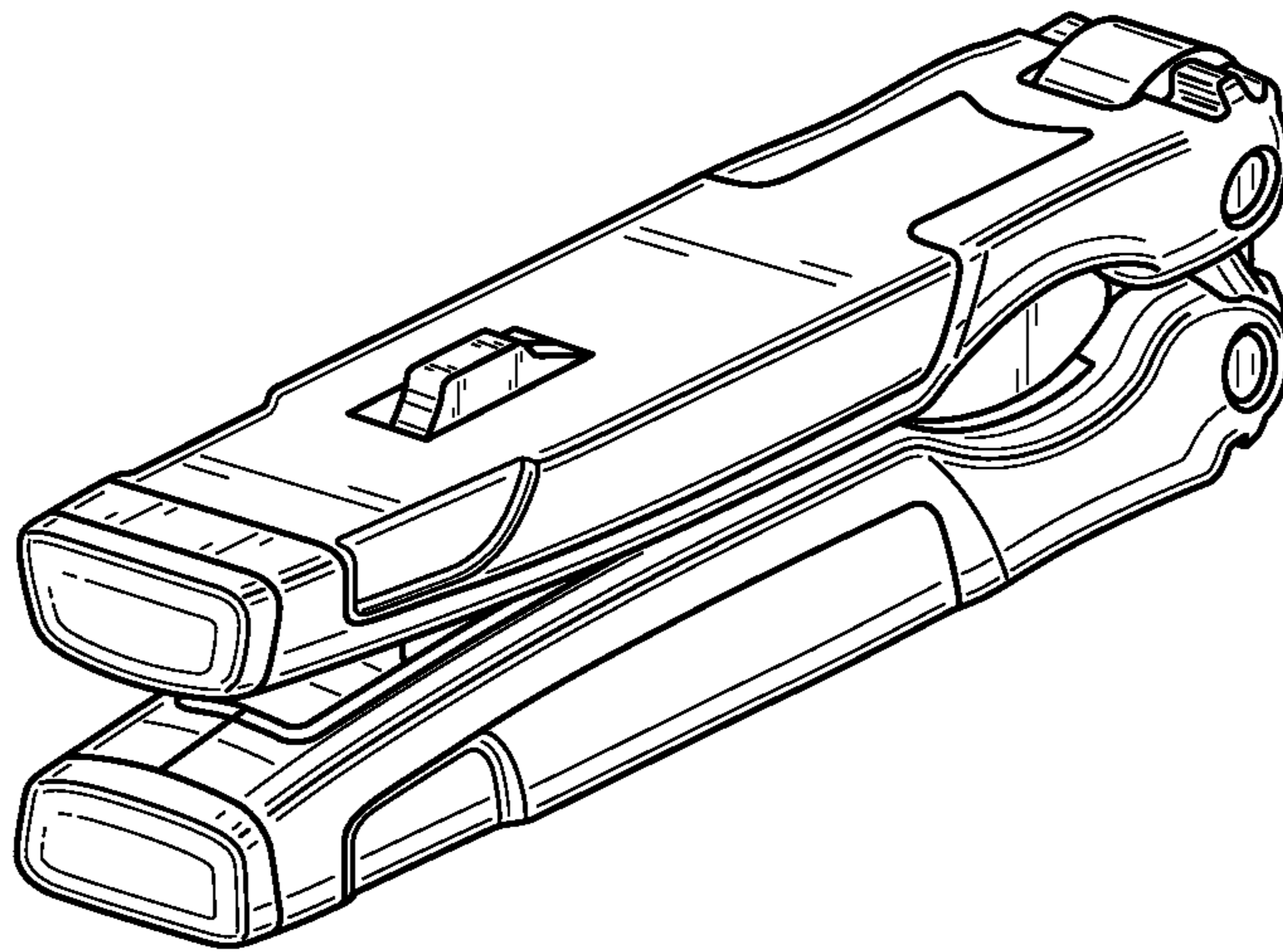

FIG. 8

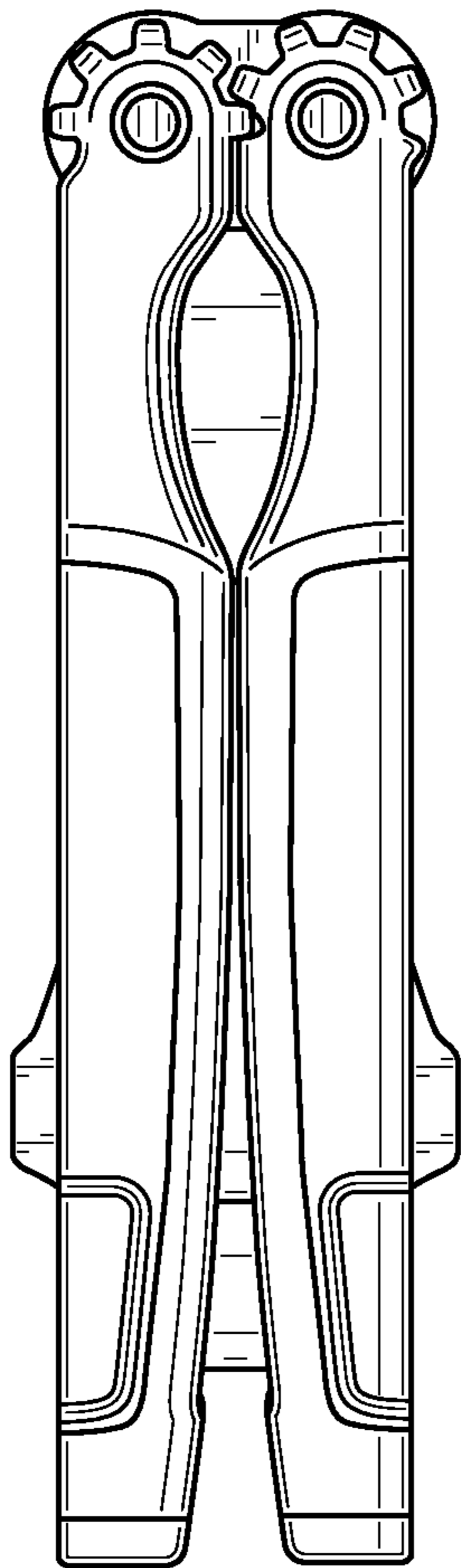

FIG. 9

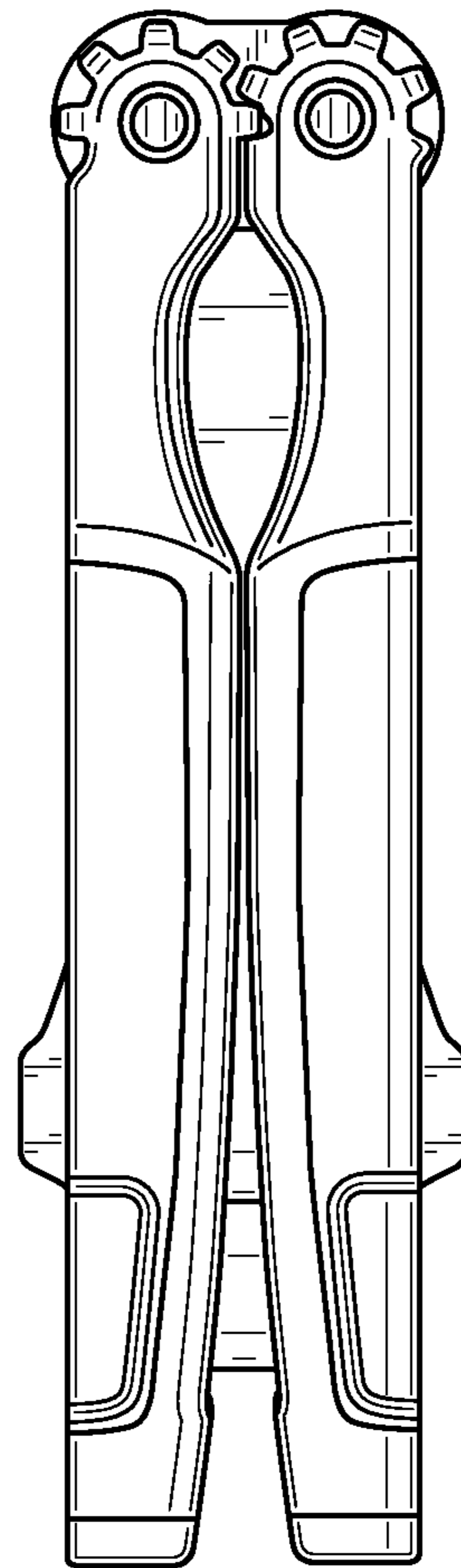

FIG. 10

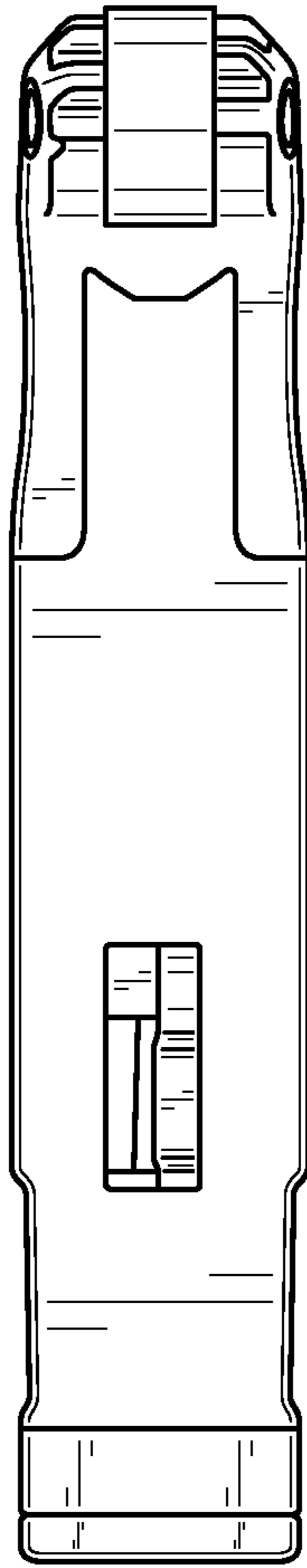

FIG. 11

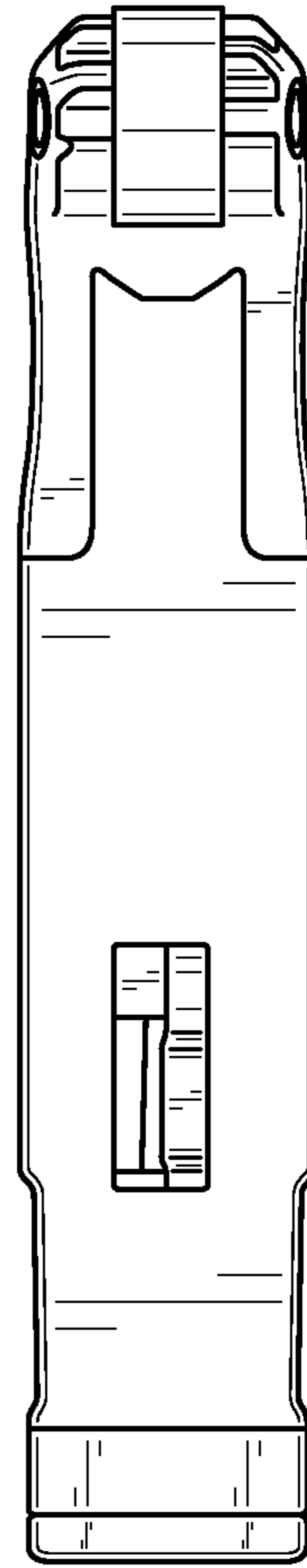

FIG. 12

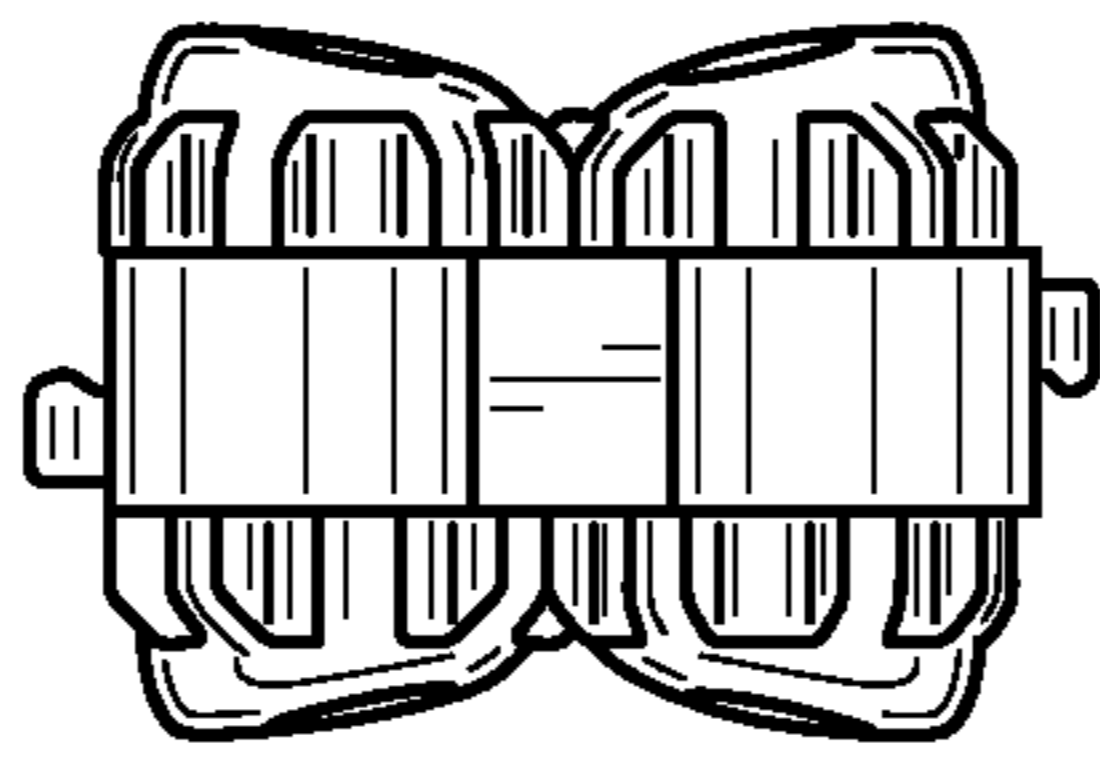

FIG. 13

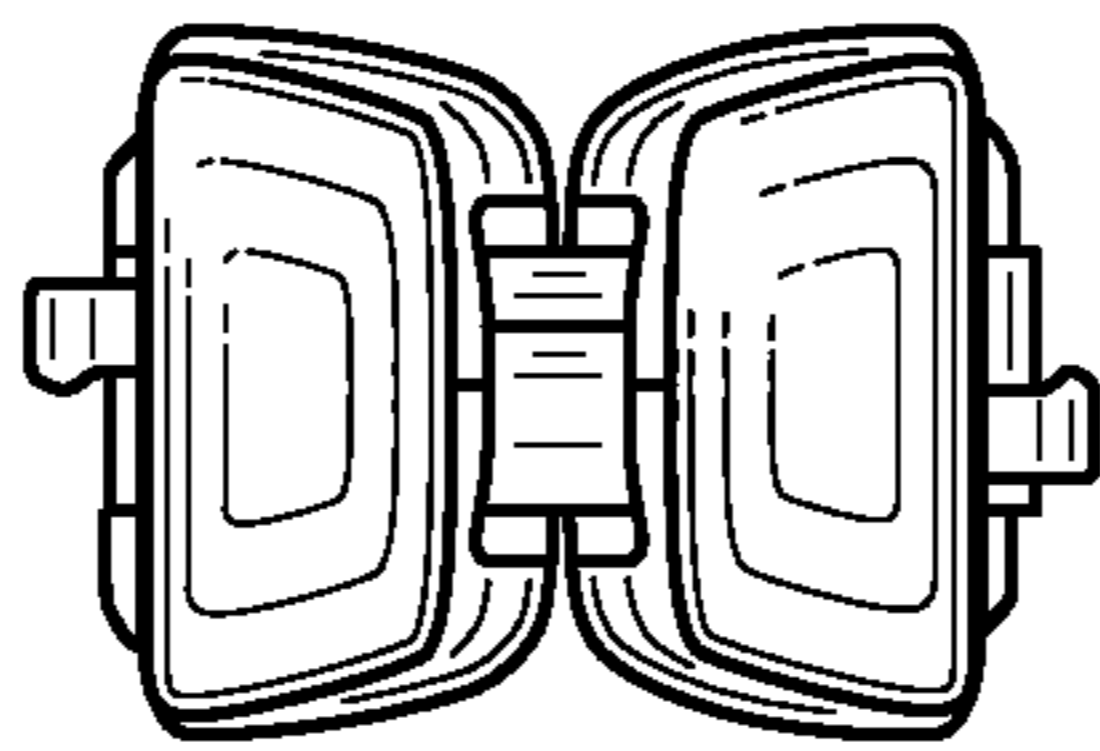

FIG. 14