



US00D710015S

(12) **United States Design Patent**
Jensen et al.

(10) **Patent No.:** **US D710,015 S**
(45) **Date of Patent:** **** Jul. 29, 2014**

(54) **ADAPTOR SHOE FOR A HEARING AID**

(75) Inventors: **Claus Erikslev Jensen**, Lynge (DK);
Torben Arnt, Lynge (DK)

(73) Assignee: **Widex A/S**, Lynge (DK)

(**) Term: **14 Years**

(21) Appl. No.: **29/424,759**

(22) Filed: **Jun. 15, 2012**

(30) **Foreign Application Priority Data**

Dec. 15, 2011 (EM) 001963182-0001

(51) **LOC (10) Cl.** **24-99**

(52) **U.S. Cl.**
USPC **D24/174**

(58) **Field of Classification Search**
USPC D24/173-175, 151; D14/205, 206,
D14/223-226, 249, 217; 381/23.1, 312,
381/322-324, 328, 330, 380, 381; 181/135
See application file for complete search history.

(56) **References Cited**

U.S. PATENT DOCUMENTS

D360,949 S * 8/1995 Mostardo D24/174
D457,635 S * 5/2002 Dittli et al. D24/174

D475,994 S * 6/2003 Schmidt et al. D14/223
D484,983 S * 1/2004 Nielsen D24/174
D493,175 S * 7/2004 Schmidt et al. D14/223
7,068,804 B2 * 6/2006 Batting 381/330
7,602,929 B2 * 10/2009 Topholm et al. 381/322
D628,560 S * 12/2010 Bodley et al. D14/217
8,077,895 B2 * 12/2011 Kral et al. 381/322
8,290,191 B2 * 10/2012 Nielsen 381/323
D673,140 S * 12/2012 Kelly et al. D14/223
2010/0202644 A1 * 8/2010 Angst et al. 381/323

* cited by examiner

Primary Examiner — Anhdao Doan

(74) *Attorney, Agent, or Firm* — Sughrue Mion, PLLC

(57) **CLAIM**

The ornamental design for an adaptor shoe for a hearing aid,
as shown and described.

DESCRIPTION

FIG. 1 is a rear view of an adaptor shoe for a hearing aid,
showing our new design;
FIG. 2 is a left side view thereof;
FIG. 3 is a front view thereof;
FIG. 4 is a top view thereof;
FIG. 5 is a right side view thereof;
FIG. 6 is a bottom view thereof; and,
FIG. 7 is a perspective view thereof.
Portions of the drawings shown in broken line represent
unclaimed portions of the adaptor shoe of a hearing aid and
form no part of the claimed design.

1 Claim, 7 Drawing Sheets

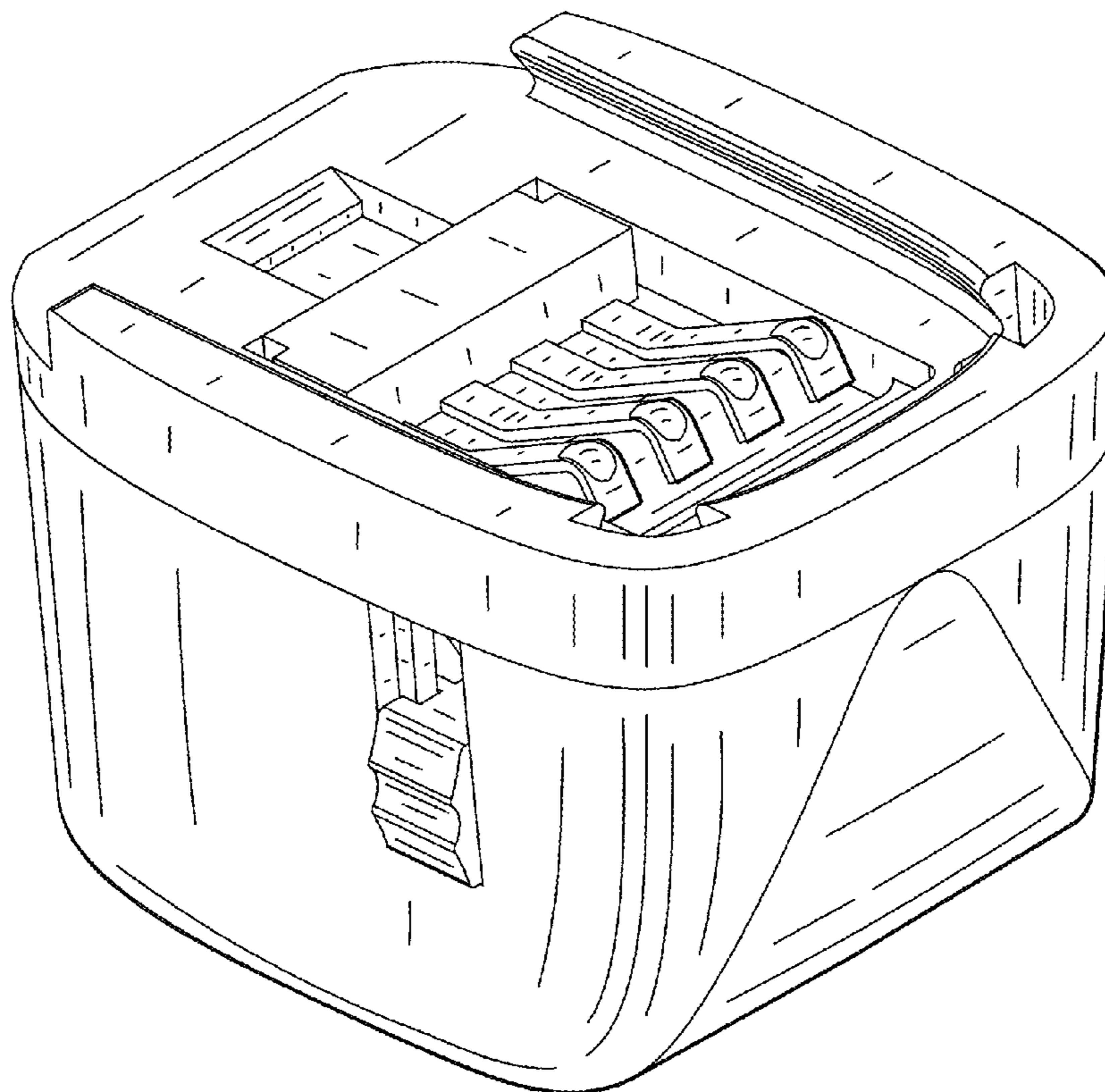

FIG. 1

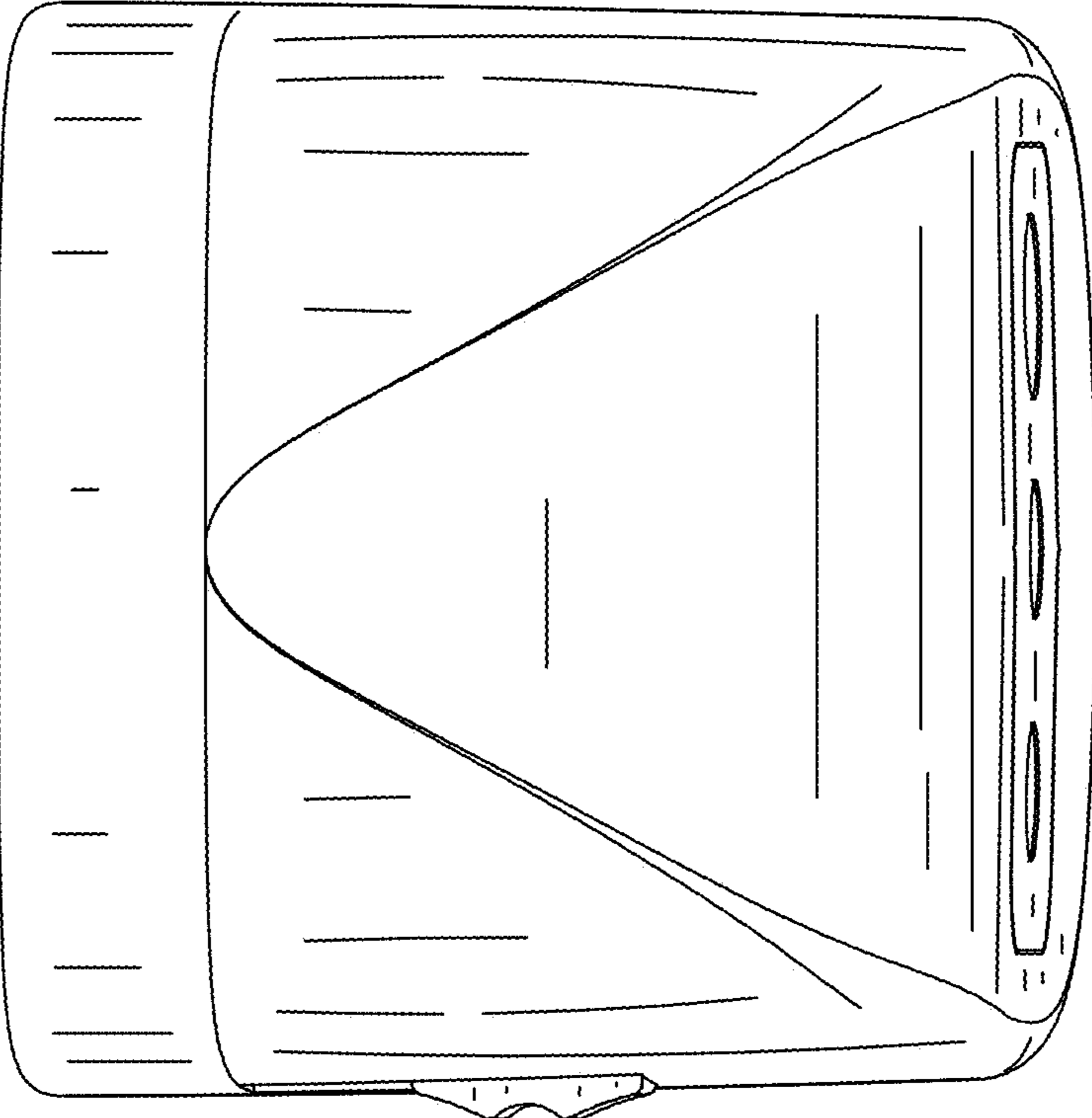

FIG. 2

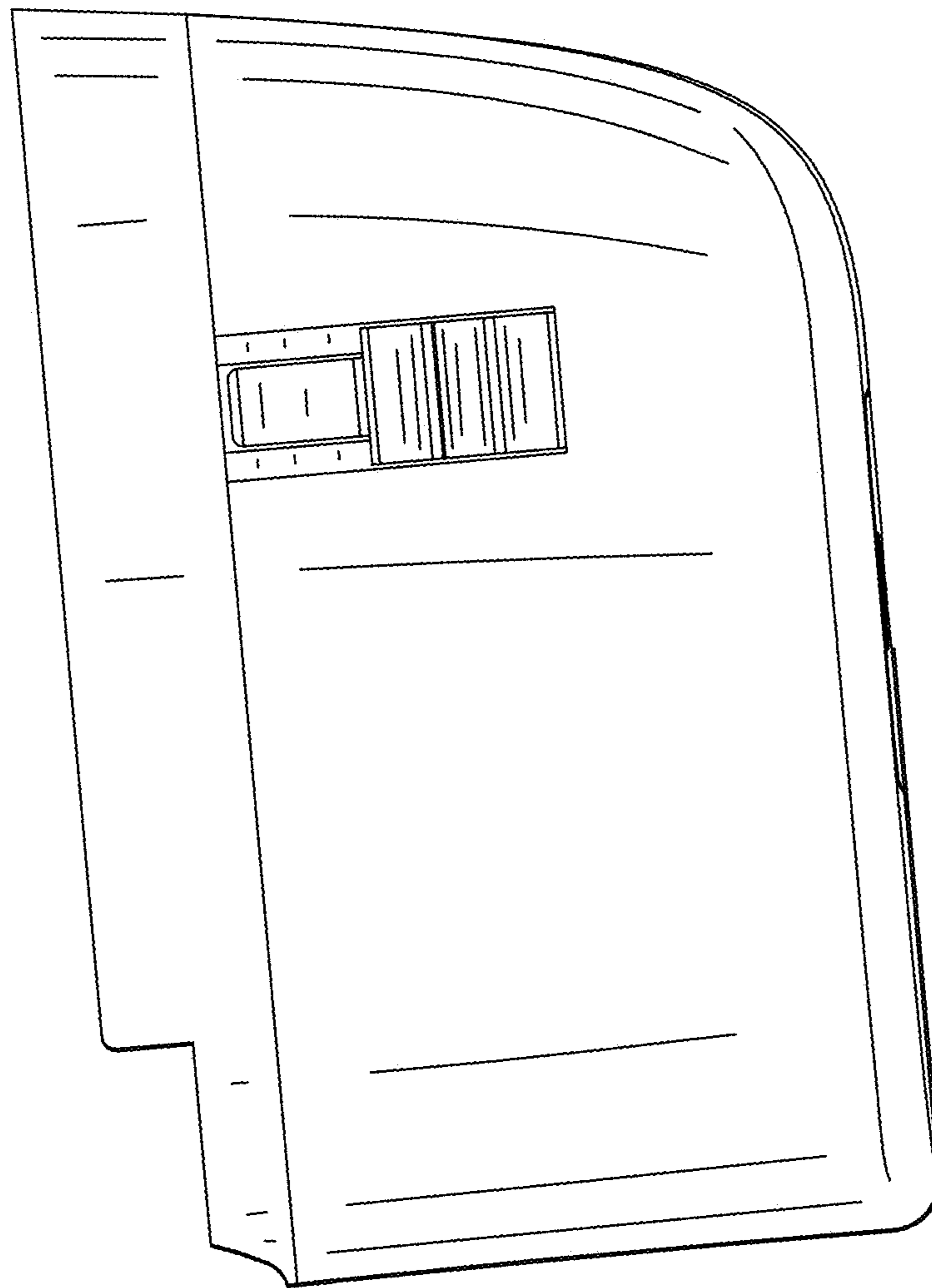

FIG. 3

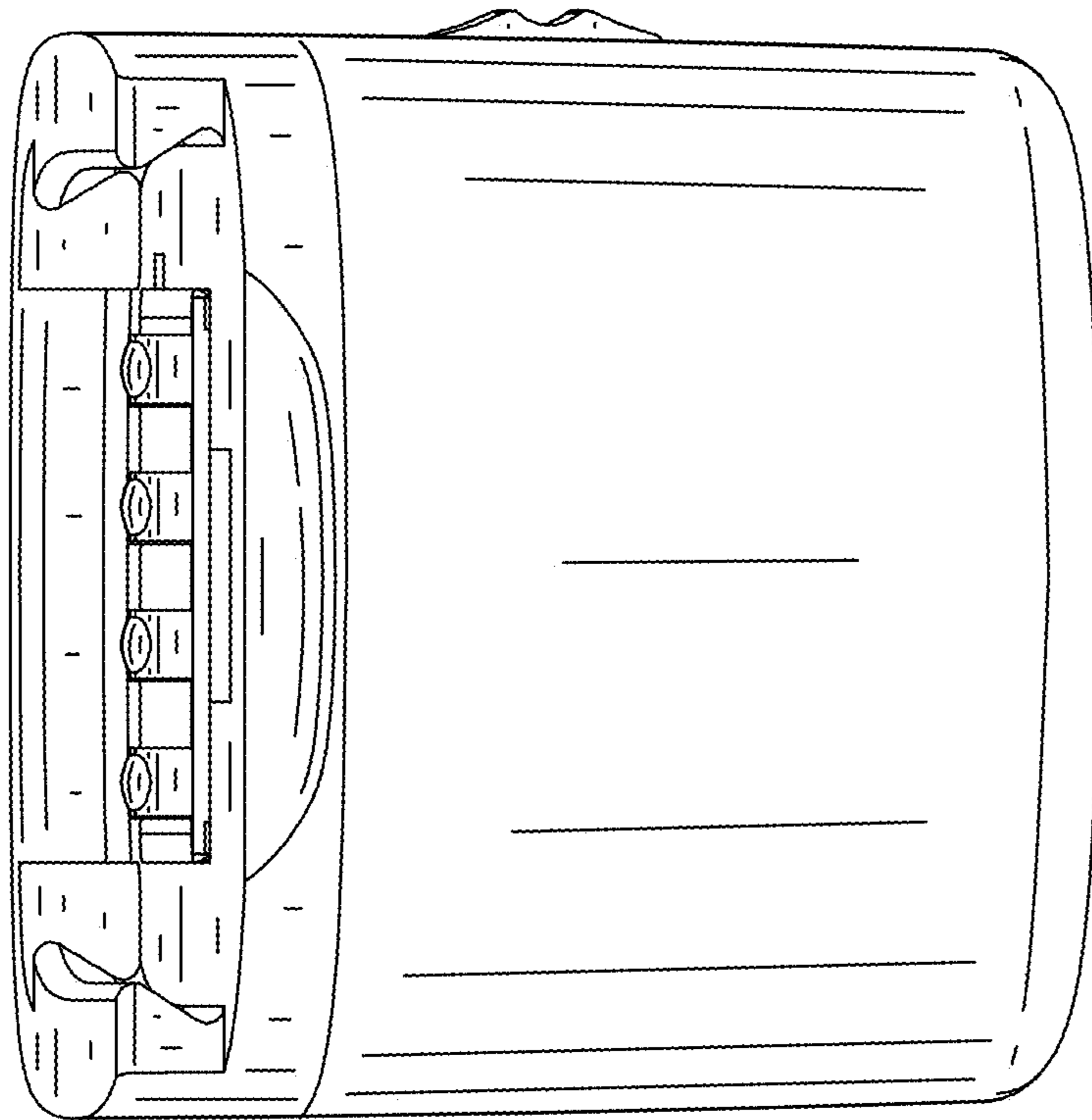

FIG. 4

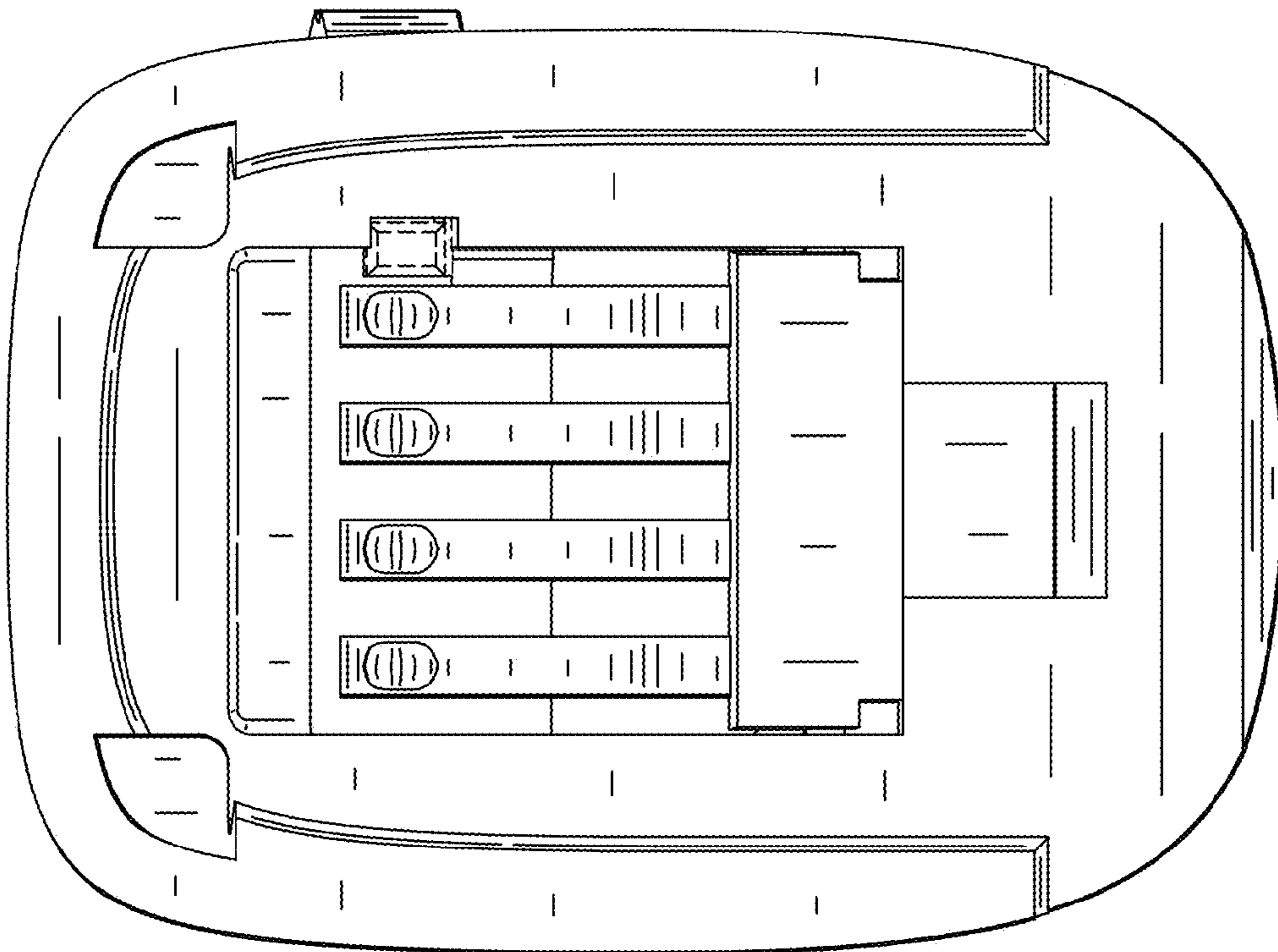

FIG. 5

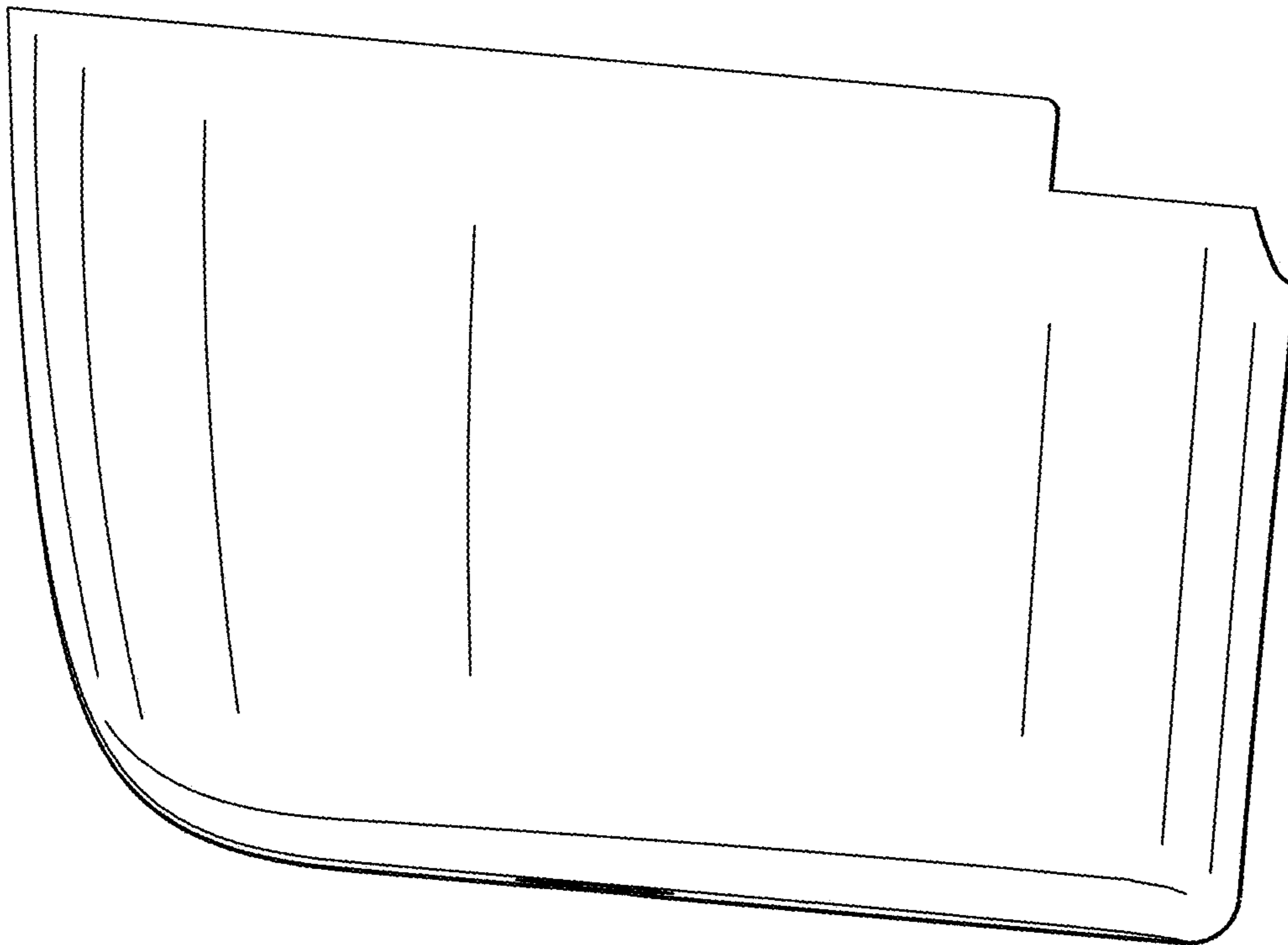

FIG. 6

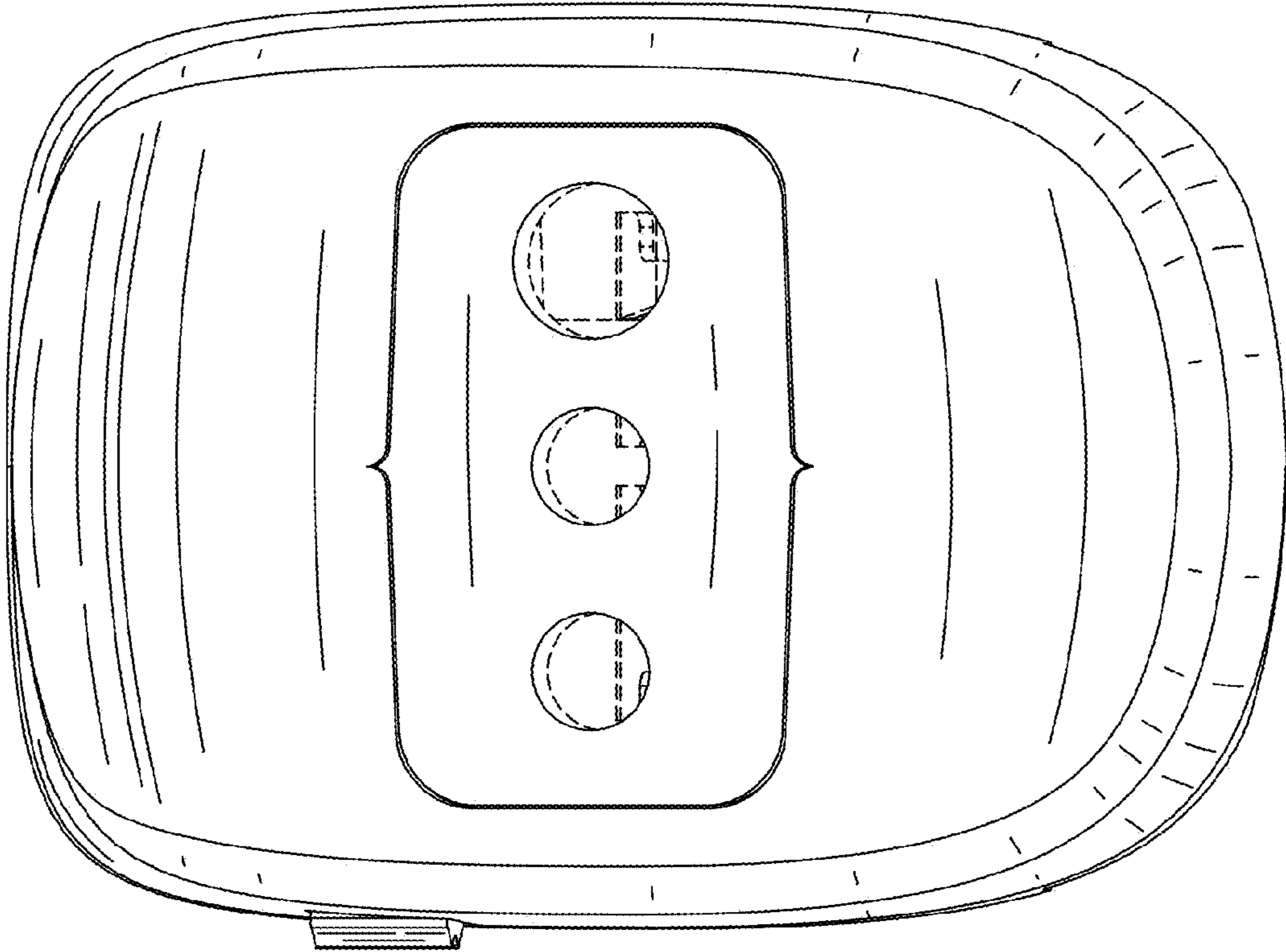

FIG. 7

