



US00D709941S

(12) **United States Design Patent**  
**Rhea et al.**

(10) **Patent No.:** **US D709,941 S**

(45) **Date of Patent:** **\*\* Jul. 29, 2014**

(54) **EYEWEAR**

(71) Applicant: **Dioptics Medical Products, Inc.**,  
Smithfield, RI (US)

(72) Inventors: **Eric Vincent Rhea**, Arroyo Grande, CA  
(US); **Matthew James St. George**,  
Pismo Beach, CA (US)

(73) Assignee: **Dioptics Medical Products, Inc.**,  
Smithfield, RI (US)

(\*\*) Term: **14 Years**

(21) Appl. No.: **29/481,627**

(22) Filed: **Feb. 7, 2014**

(51) **LOC (10) Cl.** ..... **16-06**

(52) **U.S. Cl.**  
USPC ..... **D16/315**

(58) **Field of Classification Search**  
USPC ..... D16/101, 300–342, 900; D29/109–110;  
351/41, 44, 51–52, 62, 158, 92,  
351/103–123, 140–153, 63, 59, 45–46;  
2/426–432, 447–449, 441, 434–437,  
2/13, 15; D21/483, 659–661; D14/372

See application file for complete search history.

(56) **References Cited**

U.S. PATENT DOCUMENTS

D535,682 S *	1/2007	Paulson	.....	D16/315
D599,836 S *	9/2009	Rohrbach	.....	D16/315
D603,443 S *	11/2009	Li	.....	D16/314
D623,683 S *	9/2010	Rohrbach	.....	D16/315
D628,229 S *	11/2010	Fuchs	.....	D16/315
D675,664 S *	2/2013	Moritz	.....	D16/315
D681,095 S *	4/2013	Markovitz et al.	.....	D16/315

\* cited by examiner

*Primary Examiner* — Raphael Barkai  
(74) *Attorney, Agent, or Firm* — Westberg Law Offices

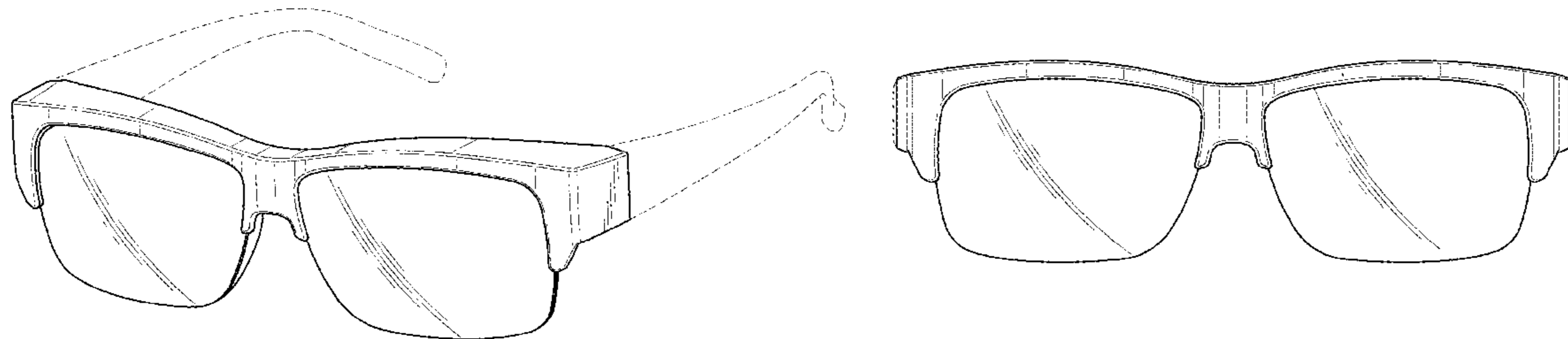
(57) **CLAIM**

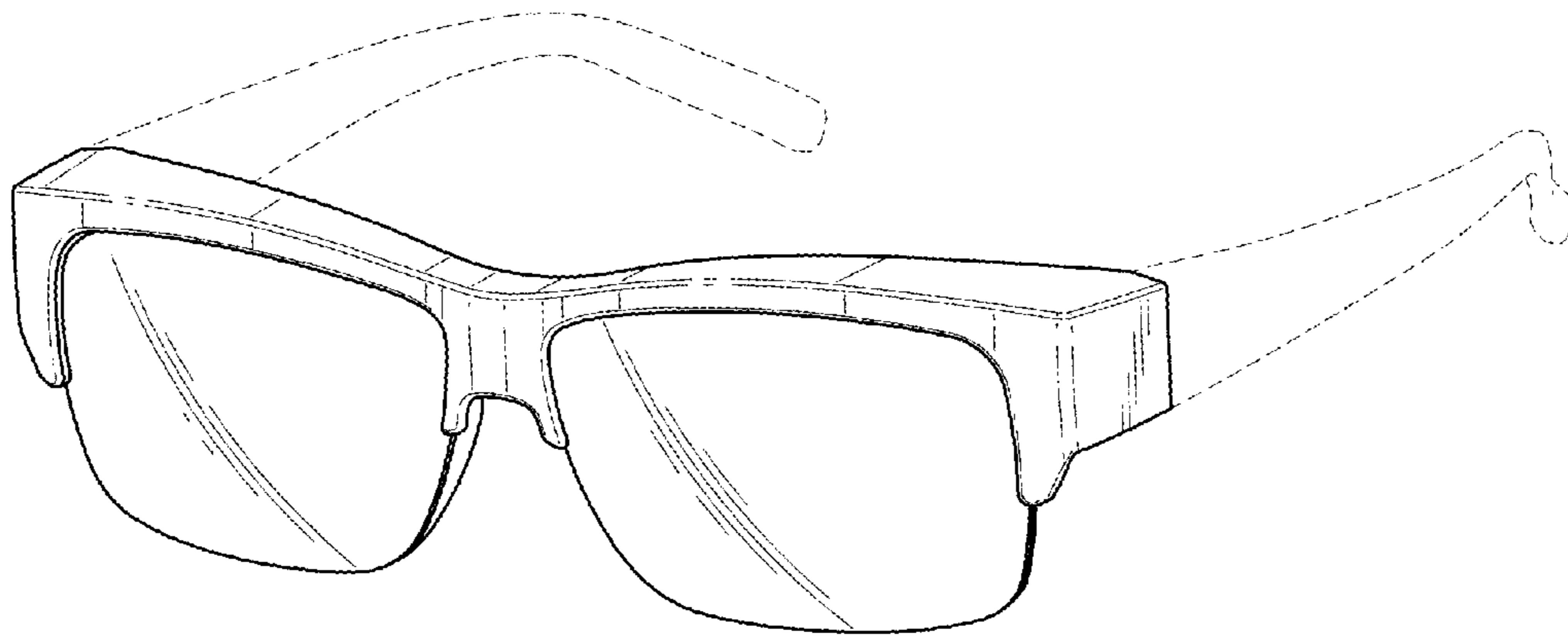
The ornamental design for eyewear, as shown and described.

**DESCRIPTION**

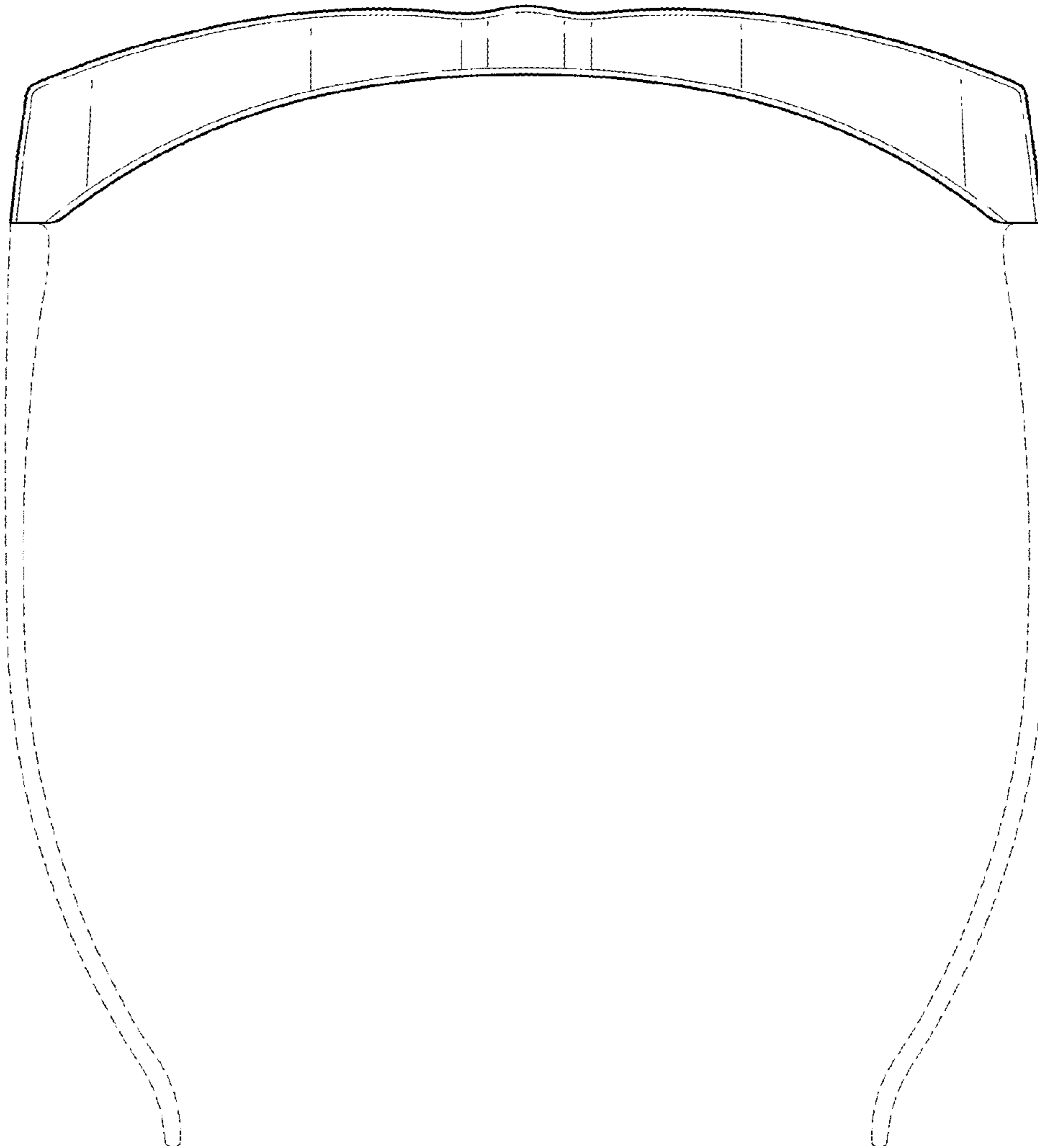
FIG. 1 is a perspective view of eyewear showing the new design;  
FIG. 2 is a top view thereof;  
FIG. 3 is a bottom view thereof;  
FIG. 4 is a front elevation view thereof;  
FIG. 5 is a rear elevation view thereof; and,  
FIG. 6 is a right side elevation view thereof, the left side being a mirror image of the right side.  
The broken lines showing temples are for illustrative purposes only and form no part of the claimed design.

**1 Claim, 4 Drawing Sheets**

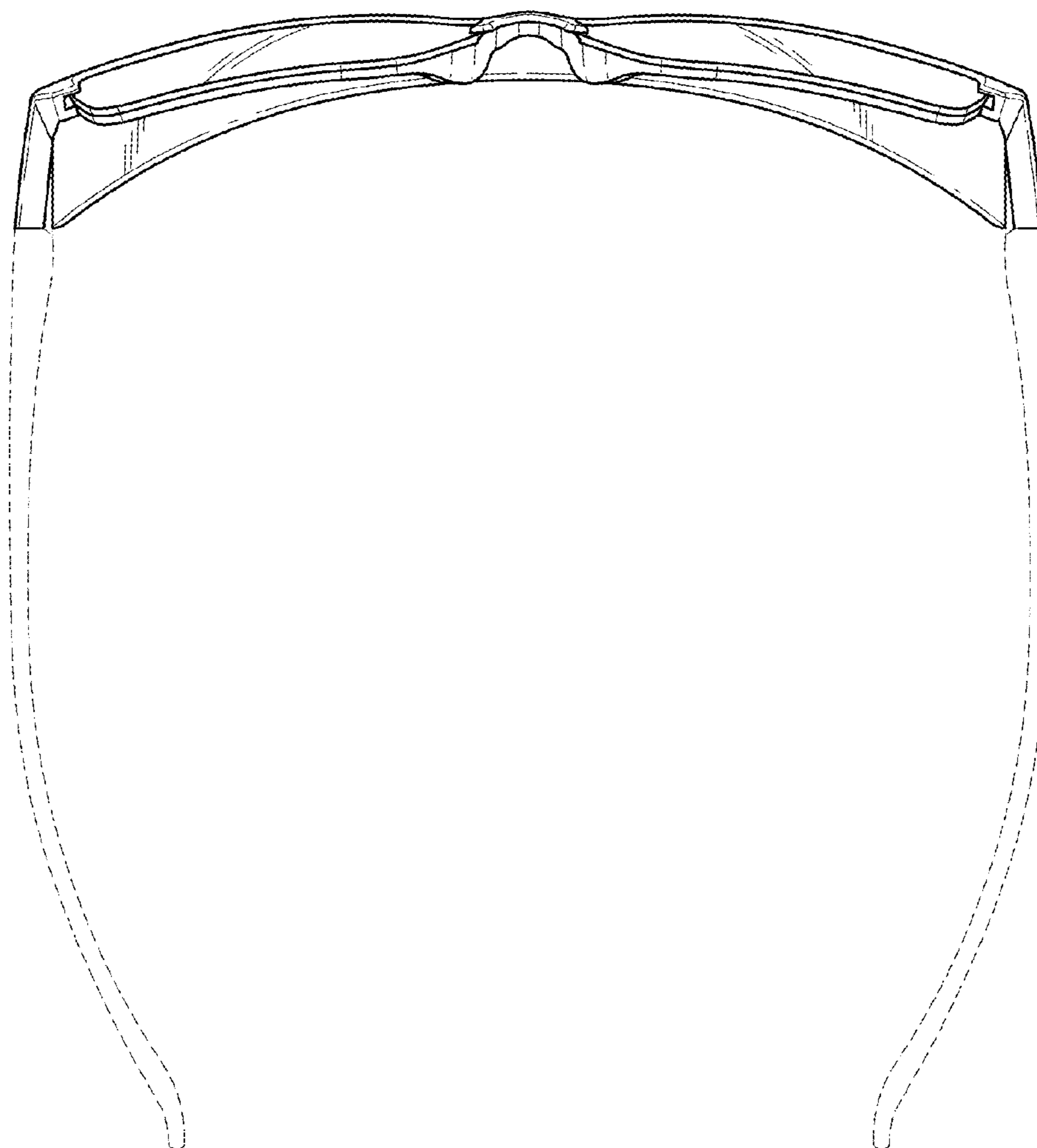




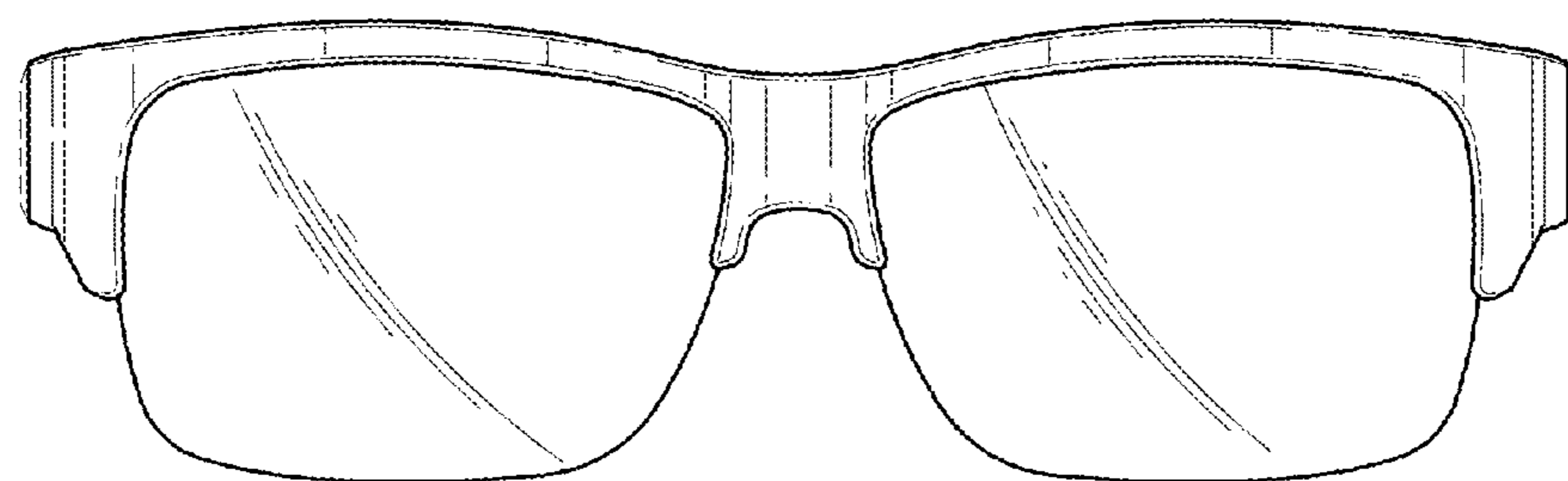
*FIG. 1*



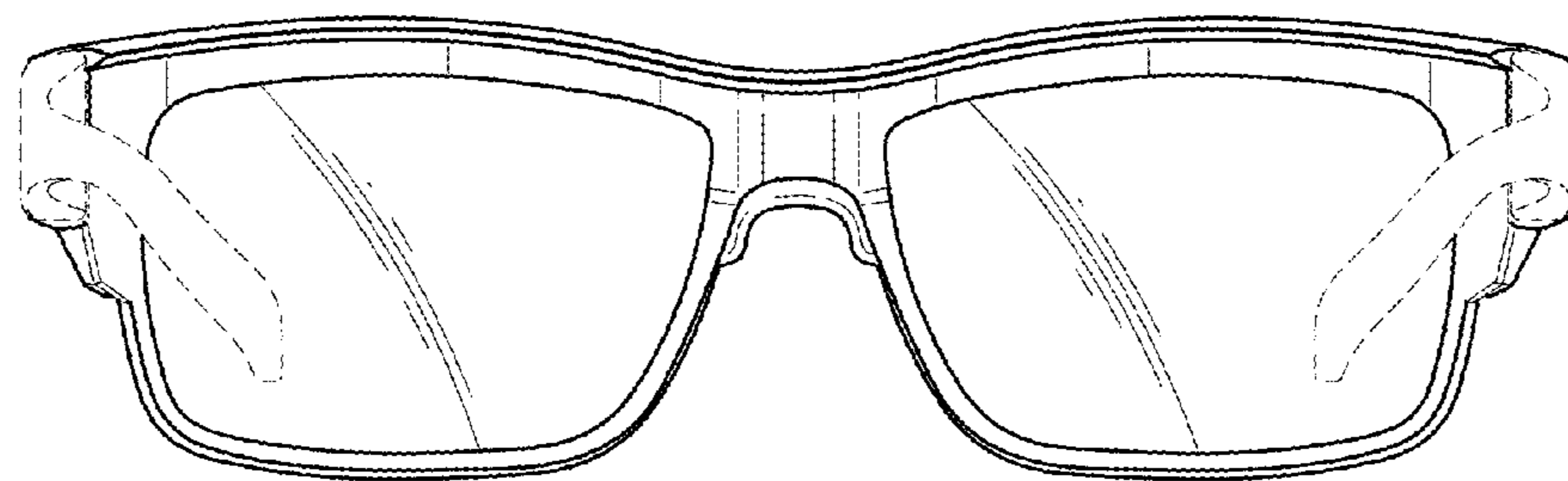
**FIG. 2**



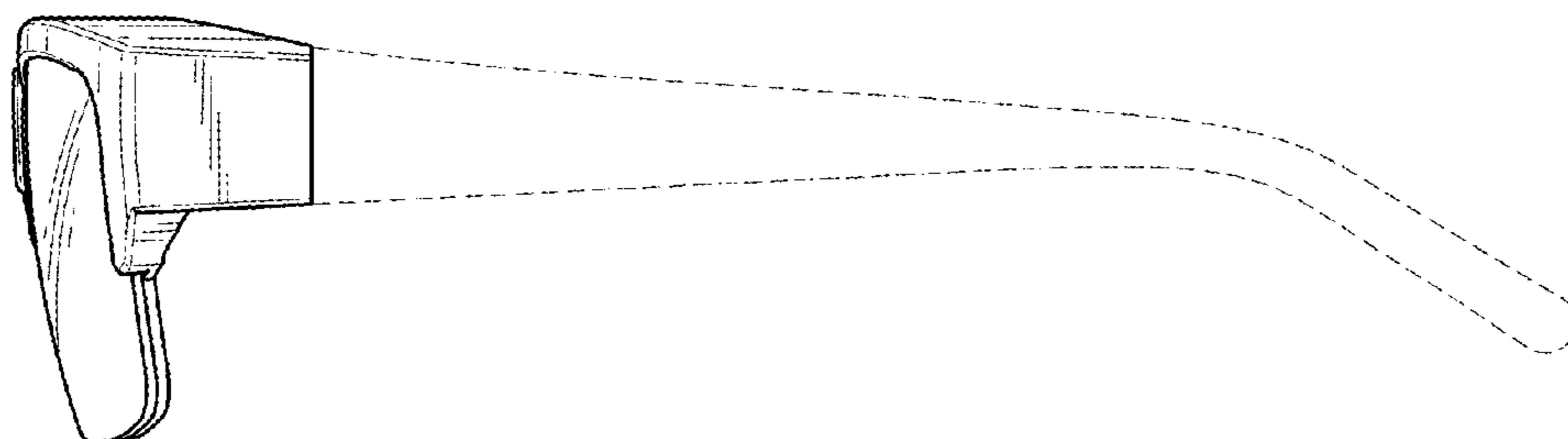
**FIG. 3**



**FIG. 4**



**FIG. 5**



**FIG. 6**