



US00D709917S

(12) **United States Design Patent**
Faulkner et al.

(10) **Patent No.:** **US D709,917 S**
(45) **Date of Patent:** **** Jul. 29, 2014**

(54) **DISPLAY SCREEN WITH ANIMATED GRAPHICAL USER INTERFACE**

(71) Applicant: **Microsoft Corporation**, Redmond, WA (US)

(72) Inventors: **Jeffrey Faulkner**, Redmond, WA (US);
Andrew Moroney, Redmond, WA (US);
Christopher Raykovich, Redmond, WA (US)

(73) Assignee: **Microsoft Corporation**, Redmond, WA (US)

(**) Term: **14 Years**

(21) Appl. No.: **29/449,059**

(22) Filed: **Mar. 14, 2013**

(51) **LOC (10) Cl.** **14-04**

(52) **U.S. Cl.**
USPC **D14/494**

(58) **Field of Classification Search**
USPC D14/485-495; 715/835, 710, 812, 777,
715/719, 727, 764; 701/414, 411, 117, 432,
701/437
See application file for complete search history.

(56) **References Cited**

U.S. PATENT DOCUMENTS

D436,599 S *	1/2001	Greene	D14/490
D544,495 S *	6/2007	Evans et al.	D14/488
D565,579 S *	4/2008	Gunn et al.	D14/485
D570,369 S *	6/2008	Fletcher	D14/489
D574,391 S *	8/2008	Kwag	D14/486

(Continued)

Primary Examiner — Kevin Rudzinski

(74) *Attorney, Agent, or Firm* — Banner & Witcoff, Ltd.

(57) **CLAIM**

The ornamental design for a display screen with animated graphical user interface, as shown and described.

DESCRIPTION

FIG. 1 is the first image in a sequence for a display screen with animated graphical user interface showing our new design; FIG. 2 is the second image thereof; FIG. 3 is the third image thereof; FIG. 4 is the fourth image thereof; FIG. 5 is the fifth image thereof; FIG. 6 is the sixth image thereof; FIG. 7 is the seventh image thereof; FIG. 8 is the eighth image thereof; FIG. 9 is the ninth image thereof; FIG. 10 is the tenth image thereof; FIG. 11 is the eleventh image thereof; FIG. 12 is the twelfth image thereof; FIG. 13 is the thirteenth image thereof; FIG. 14 is the fourteenth image thereof; FIG. 15 is the first image in the sequence of FIGS. 1-14 shown without additional disclaimed environment; FIG. 16 is the second image thereof; FIG. 17 is the third image thereof; FIG. 18 is the fourth image thereof; FIG. 19 is the fifth image thereof; FIG. 20 is the sixth image thereof; FIG. 21 is the seventh image thereof; FIG. 22 is the eighth image thereof; FIG. 23 is the ninth image thereof; FIG. 24 is the tenth image thereof; FIG. 25 is the eleventh image thereof; FIG. 26 is the twelfth image thereof; FIG. 27 is the thirteenth image thereof; and, FIG. 28 is the fourteenth image thereof.

The appearance of the animated graphical user interface sequentially transitions between the images shown in FIGS. 1-14 and FIGS. 15-28. The process or period in which one image transitions to another forms no part of the claimed design. The broken line showing of the remainder of the user interface and display screen is for environmental purposes only and forms no part of the claimed design.

1 Claim, 28 Drawing Sheets

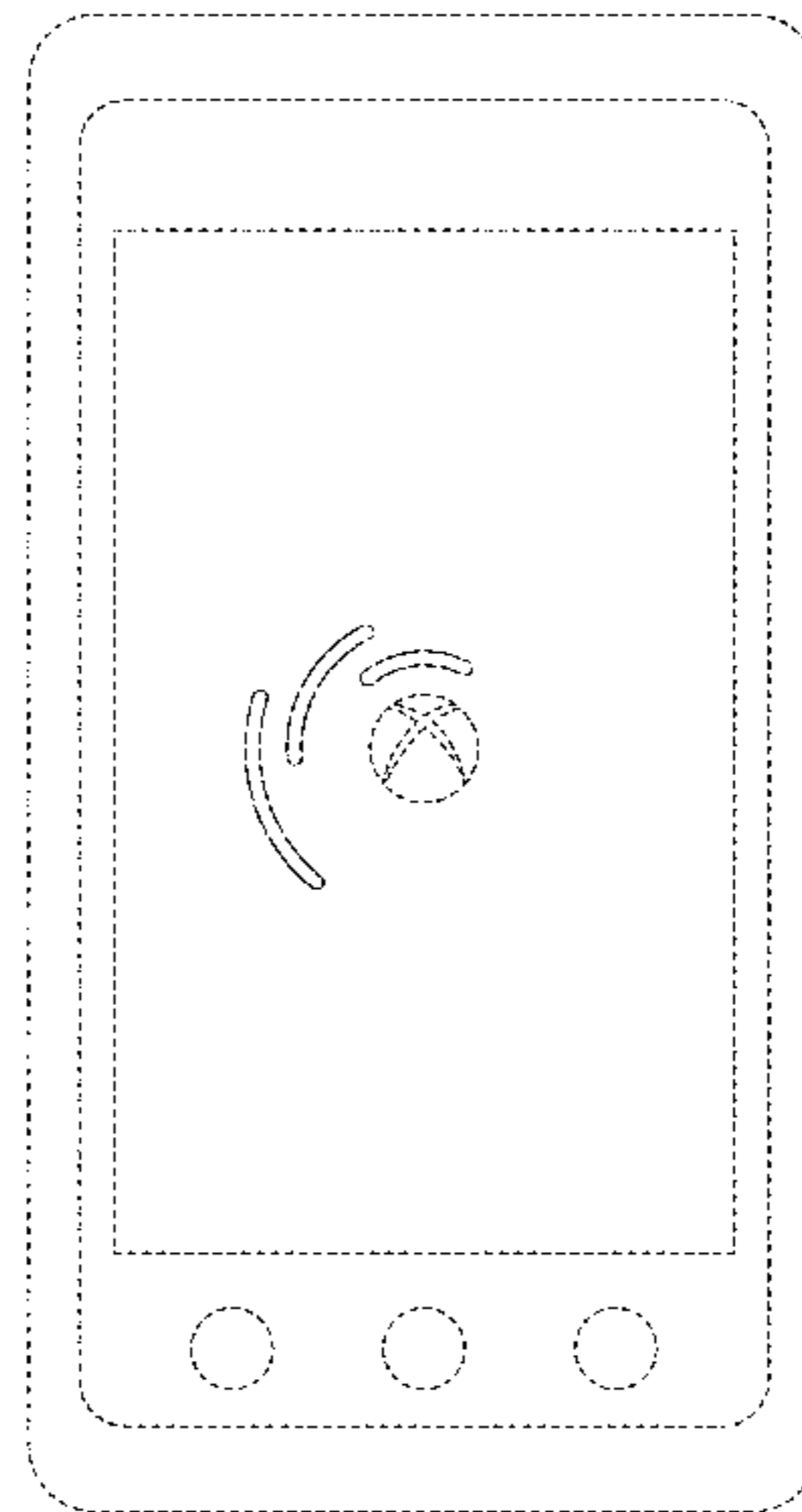
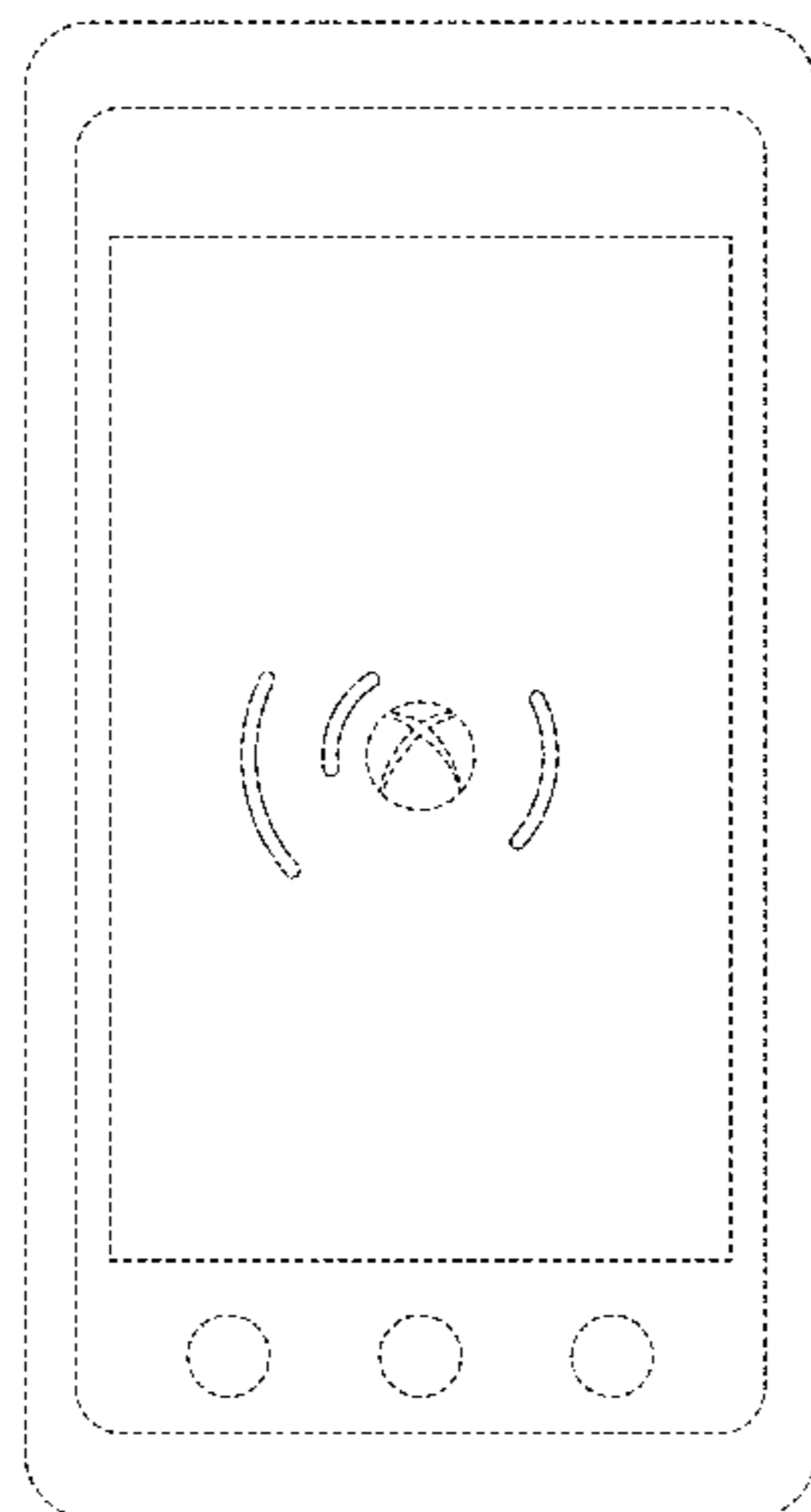

(56)

References Cited

U.S. PATENT DOCUMENTS

D582,940 S * 12/2008 Carpenter et al. D14/493
D599,814 S * 9/2009 Ogura et al. D14/489
D601,159 S * 9/2009 Truelove et al. D14/489
D607,893 S * 1/2010 Kanga et al. D14/485
D613,301 S * 4/2010 Lee et al. D14/489
D614,654 S * 4/2010 Winjum et al. D14/489
D619,145 S * 7/2010 Ebeling et al. D14/489
D625,324 S * 10/2010 Fitzmaurice et al. D14/488

D645,470 S * 9/2011 Matas D14/489
D667,450 S * 9/2012 Eby et al. D14/492
D668,674 S * 10/2012 Suarez D14/492
D669,497 S * 10/2012 Lee et al. D14/489
D669,499 S * 10/2012 Gardner et al. D14/495
D675,640 S * 2/2013 Frost et al. D14/488
D686,222 S 7/2013 Zurawski et al.
D688,700 S * 8/2013 Brown et al. D14/489
D698,363 S * 1/2014 Asai D14/488
2006/0107232 A1* 5/2006 Salt et al. 715/810

* cited by examiner

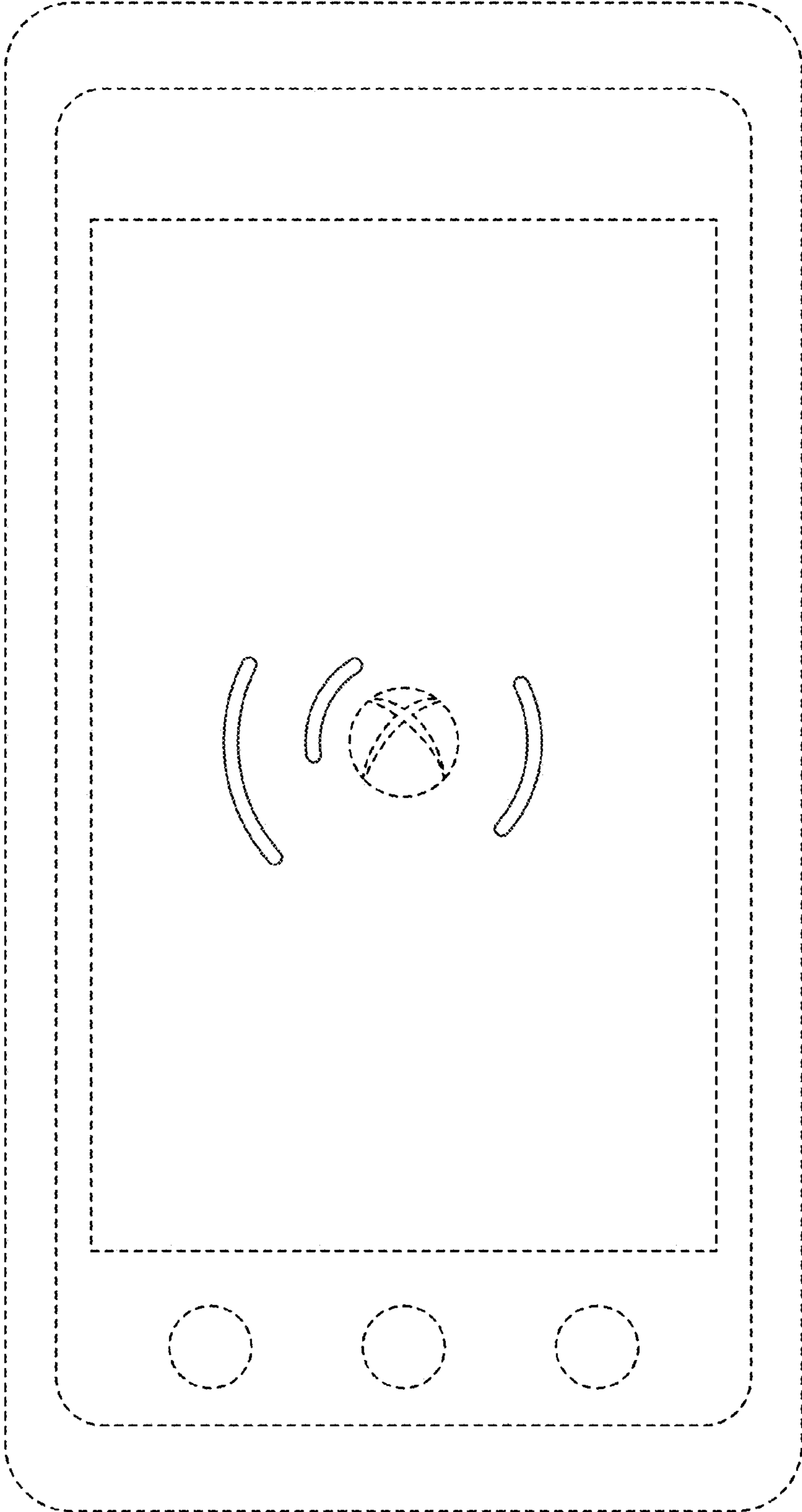

FIG. 1

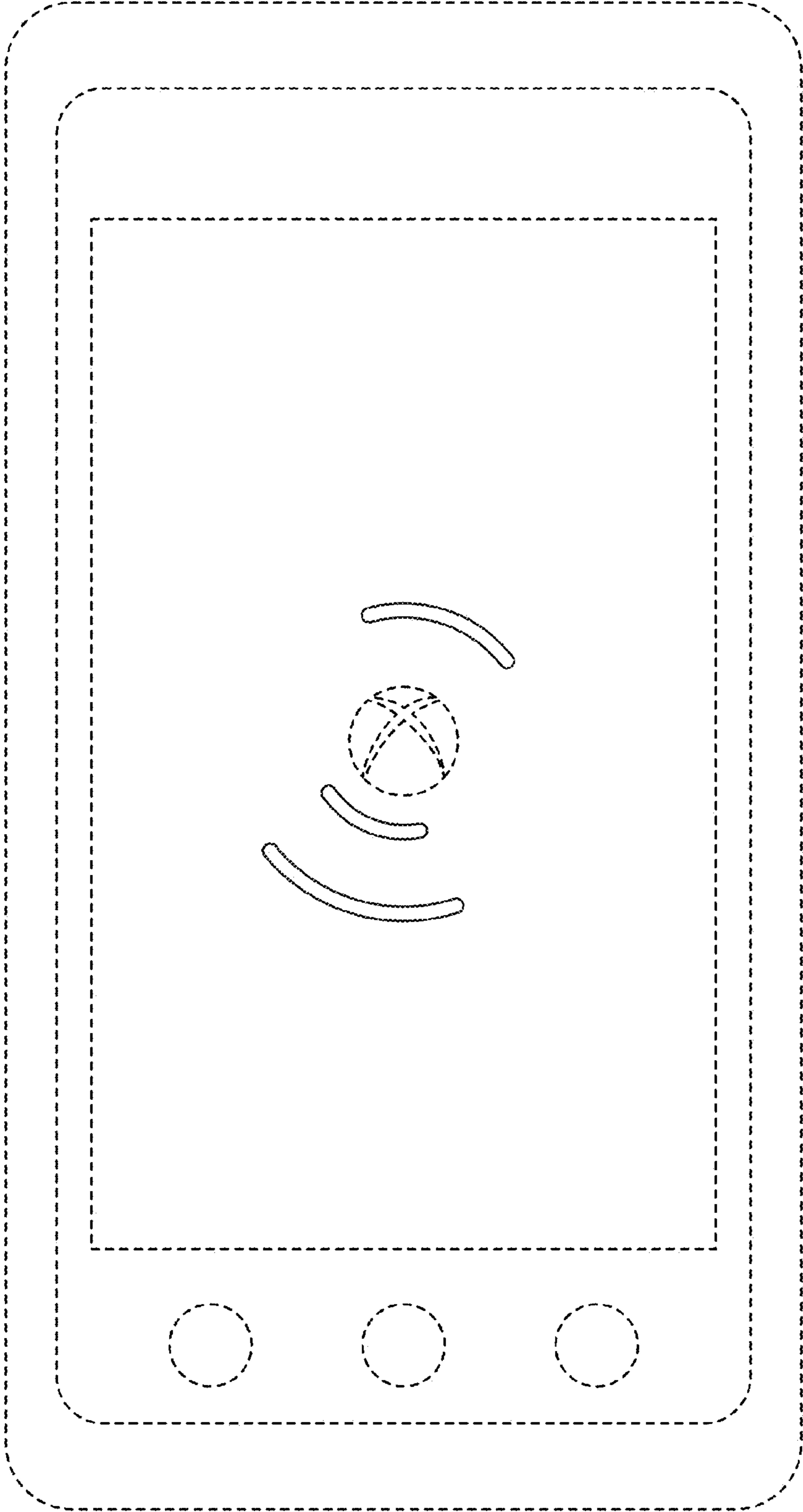

FIG. 2

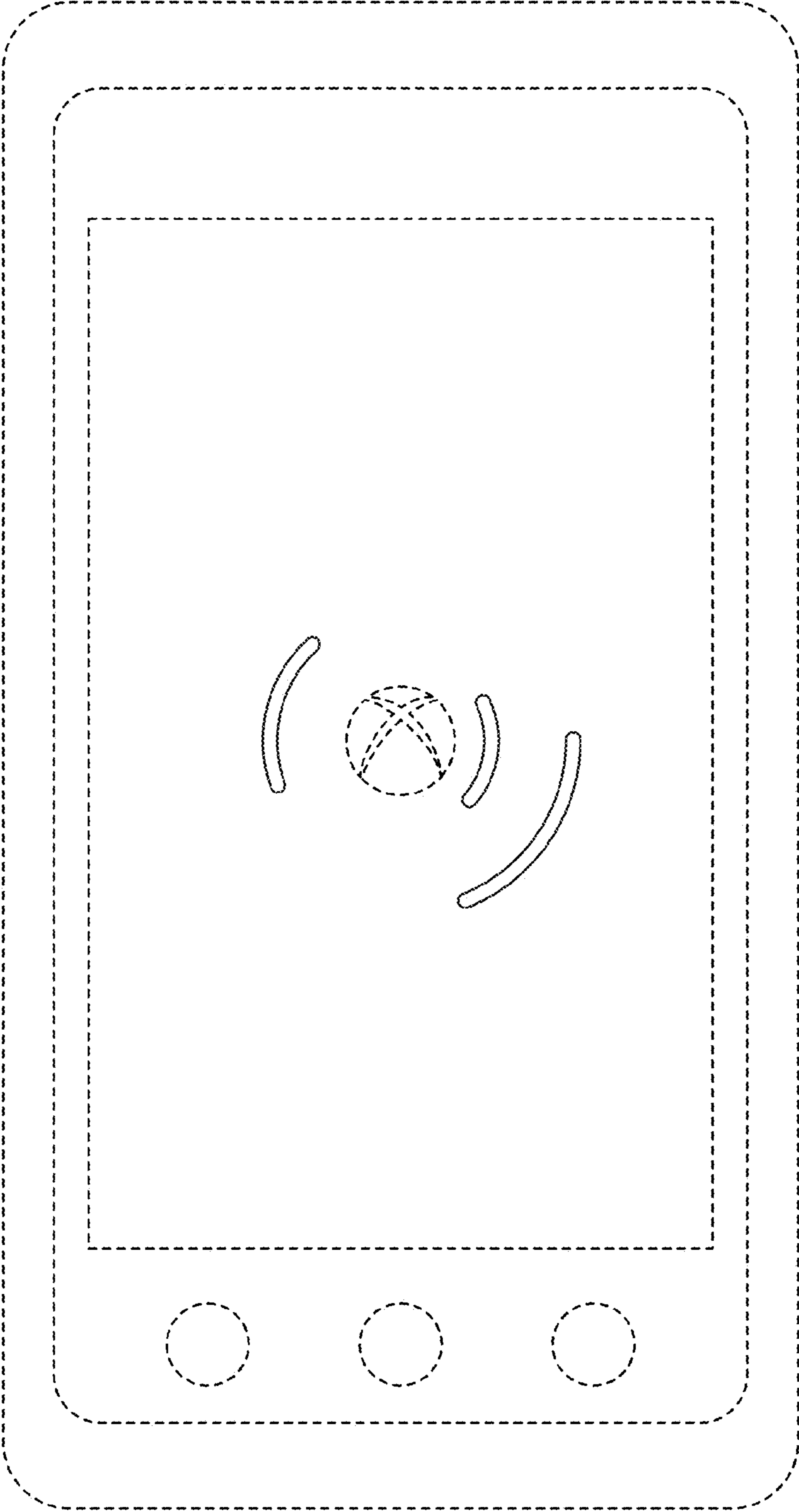

FIG. 3

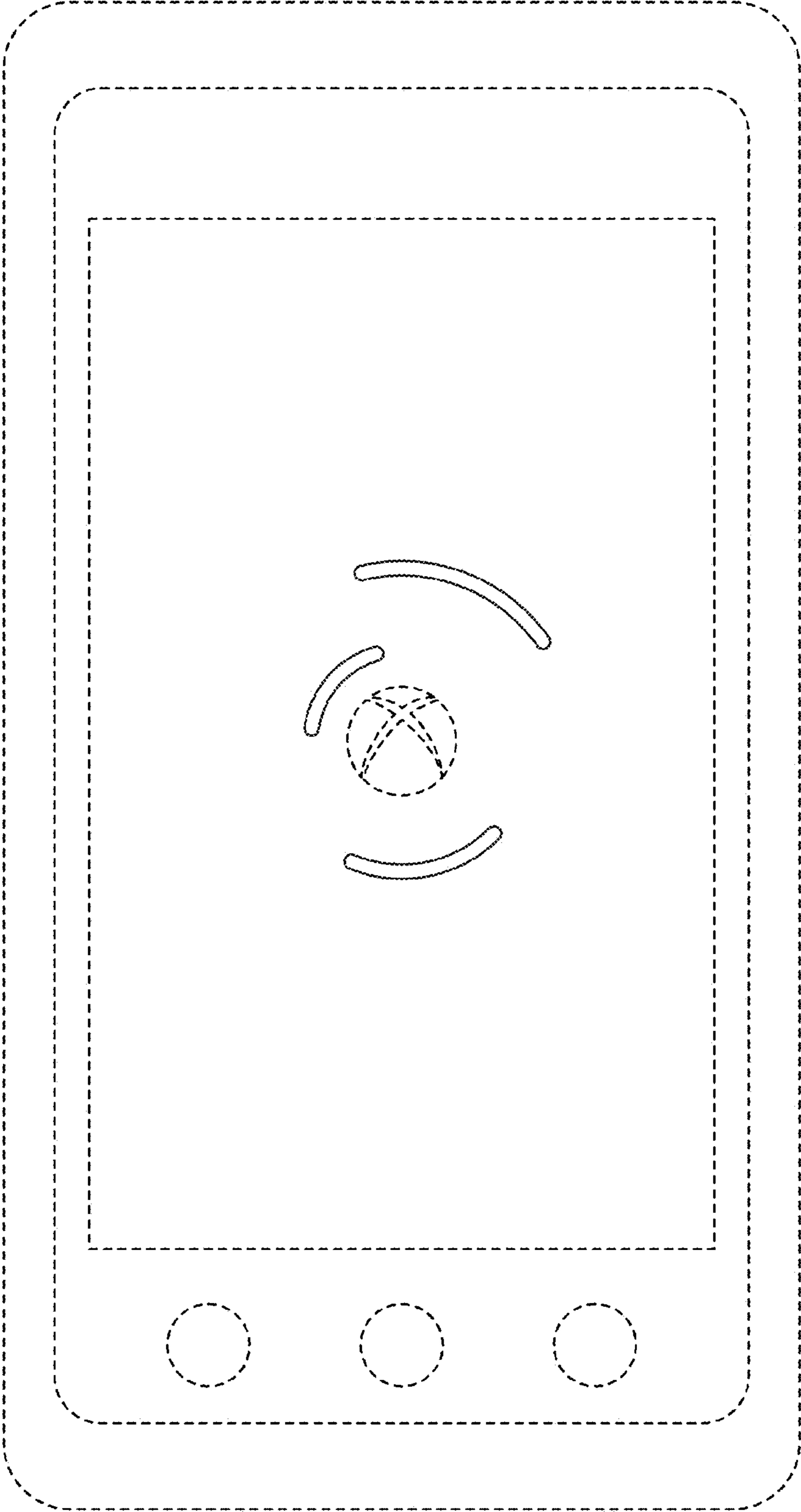

FIG. 4

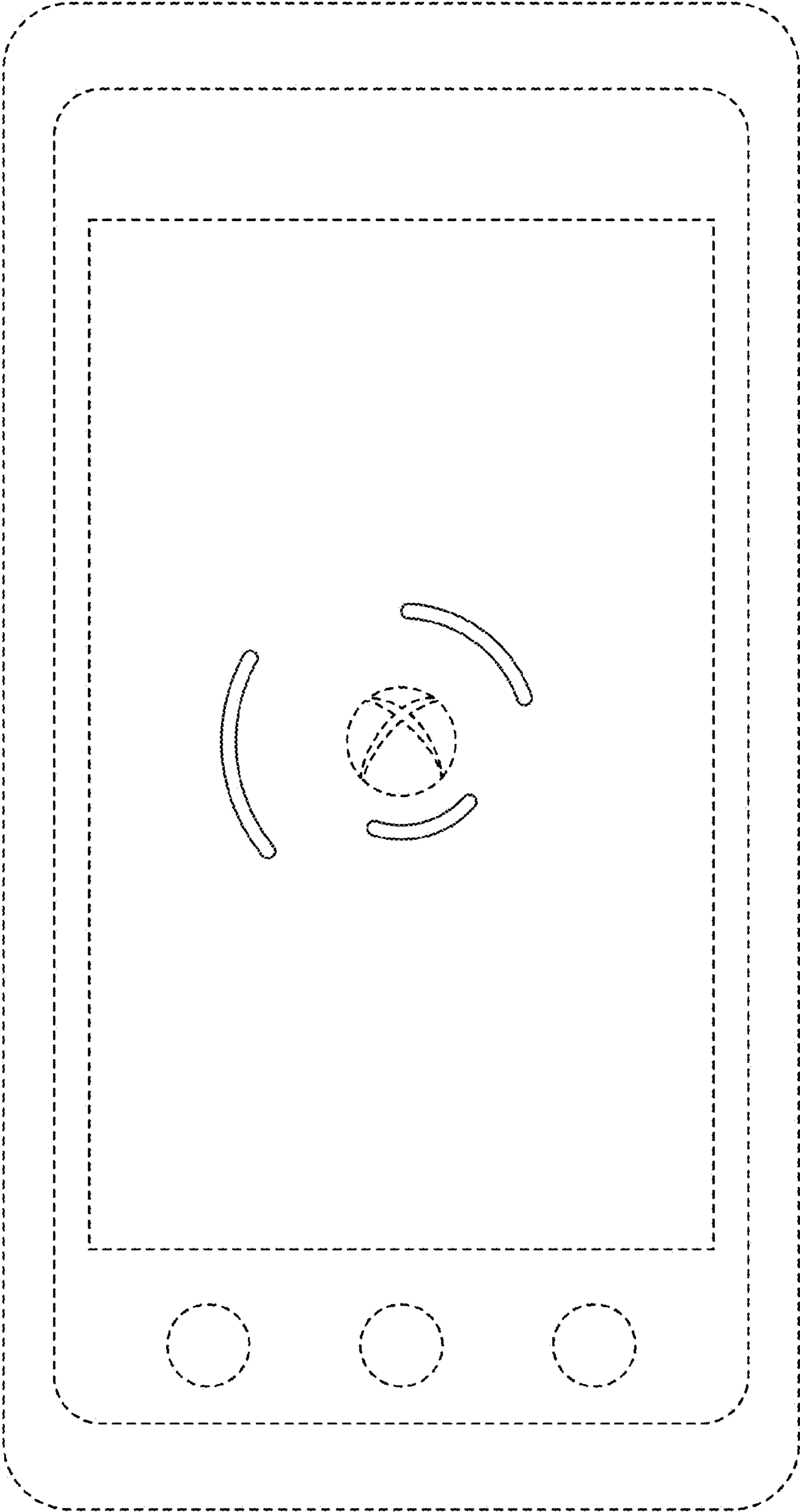

FIG. 5

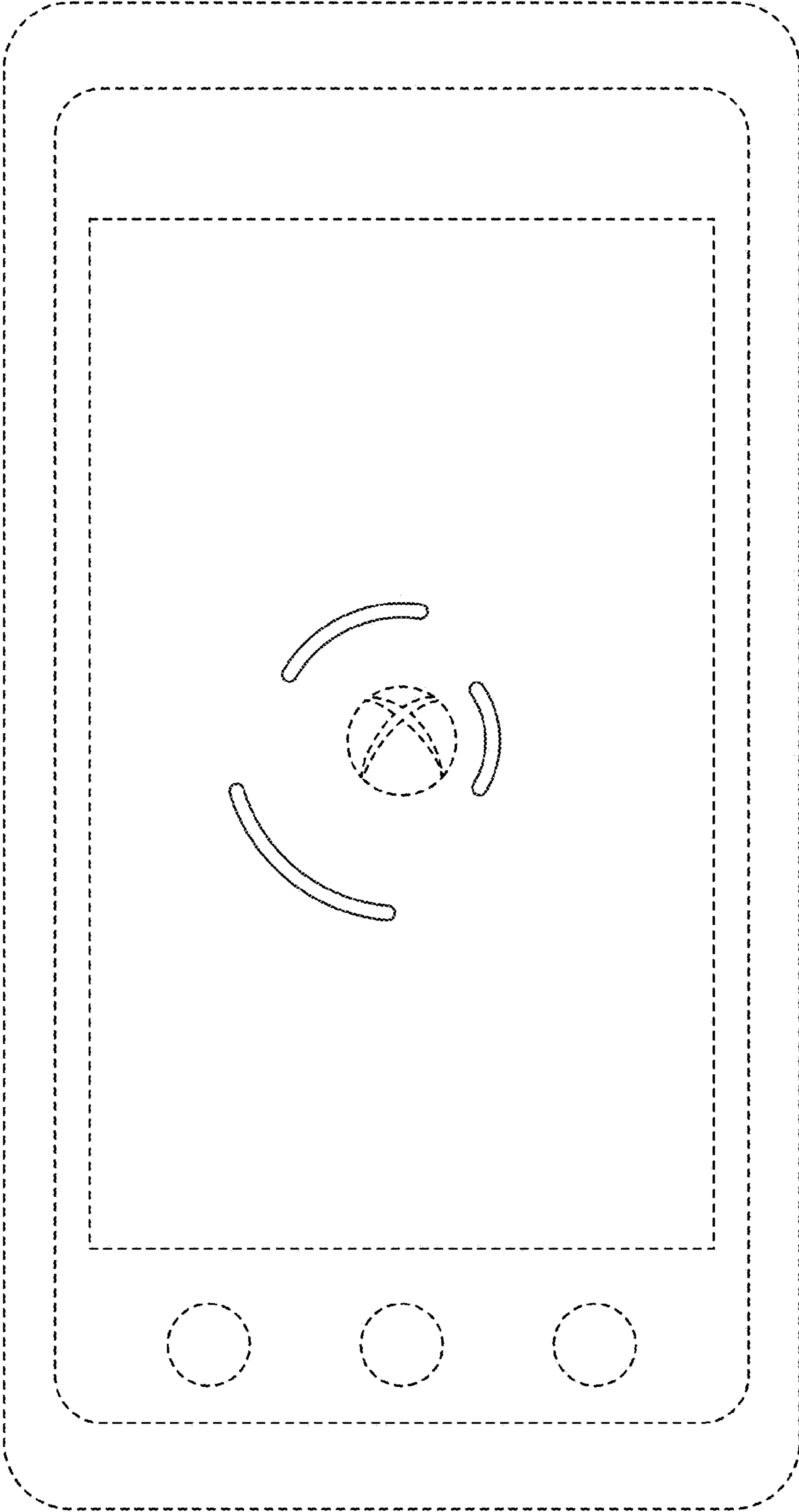

FIG. 6

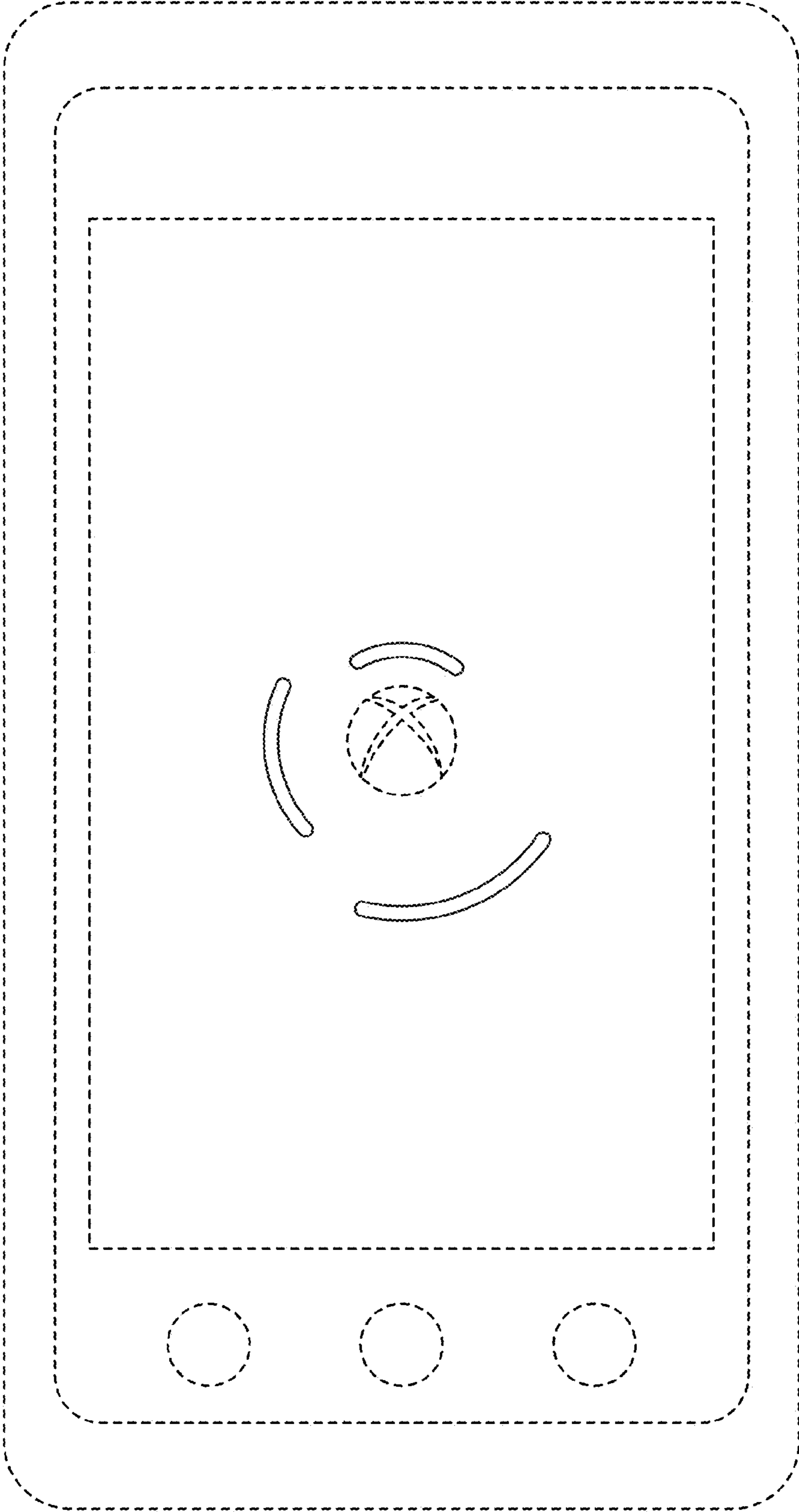

FIG. 7

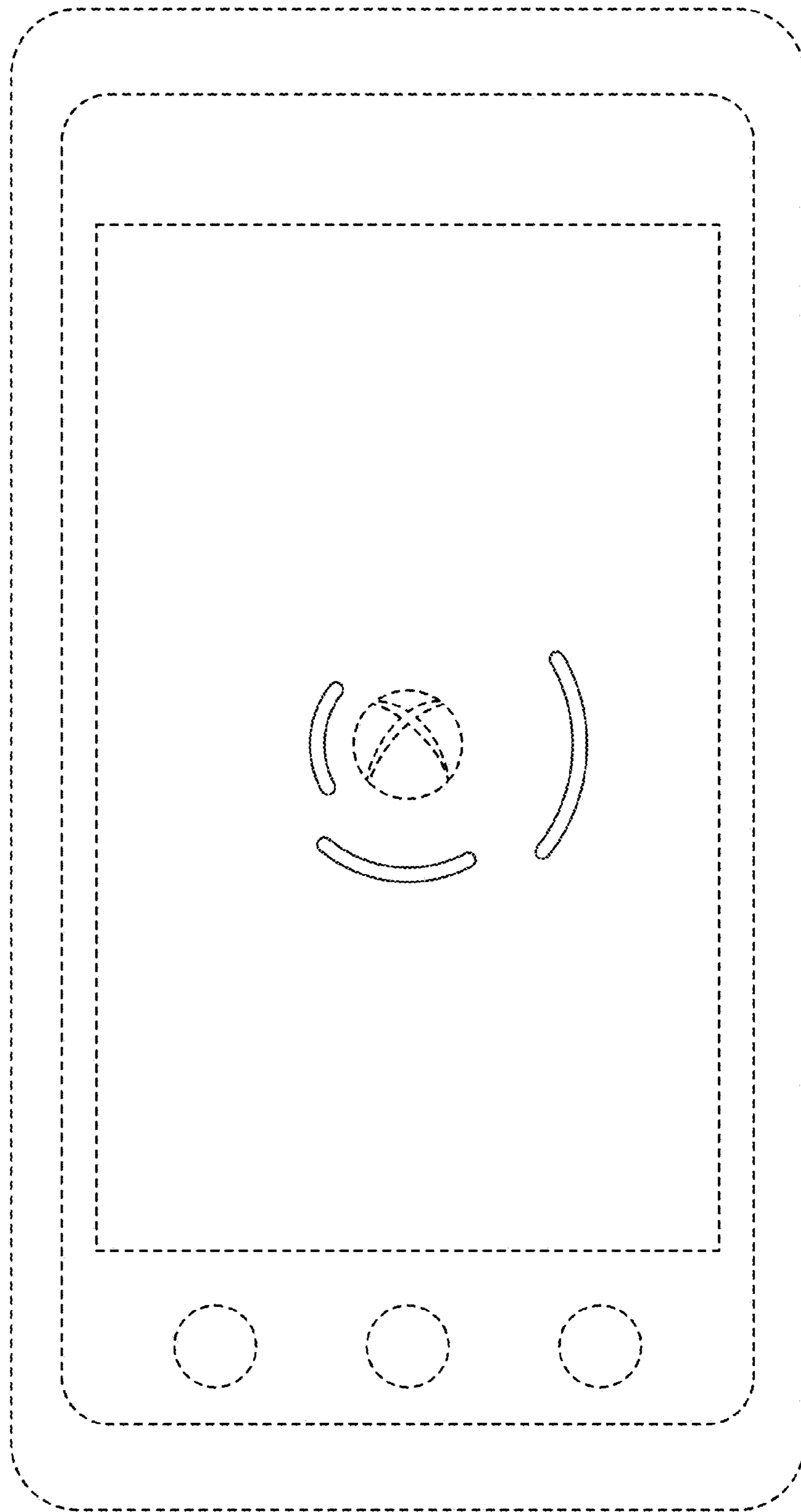

FIG. 8

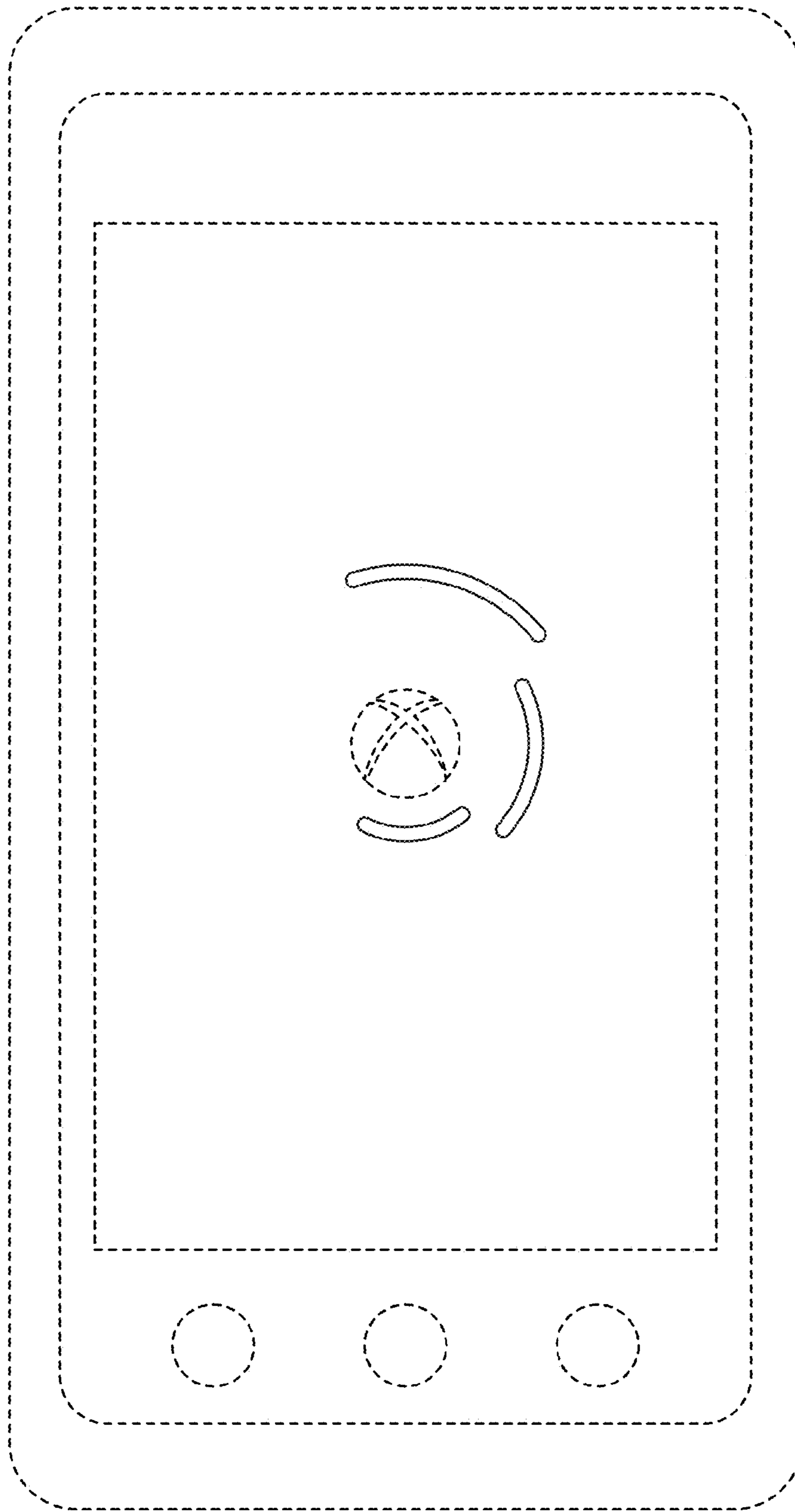

FIG. 9

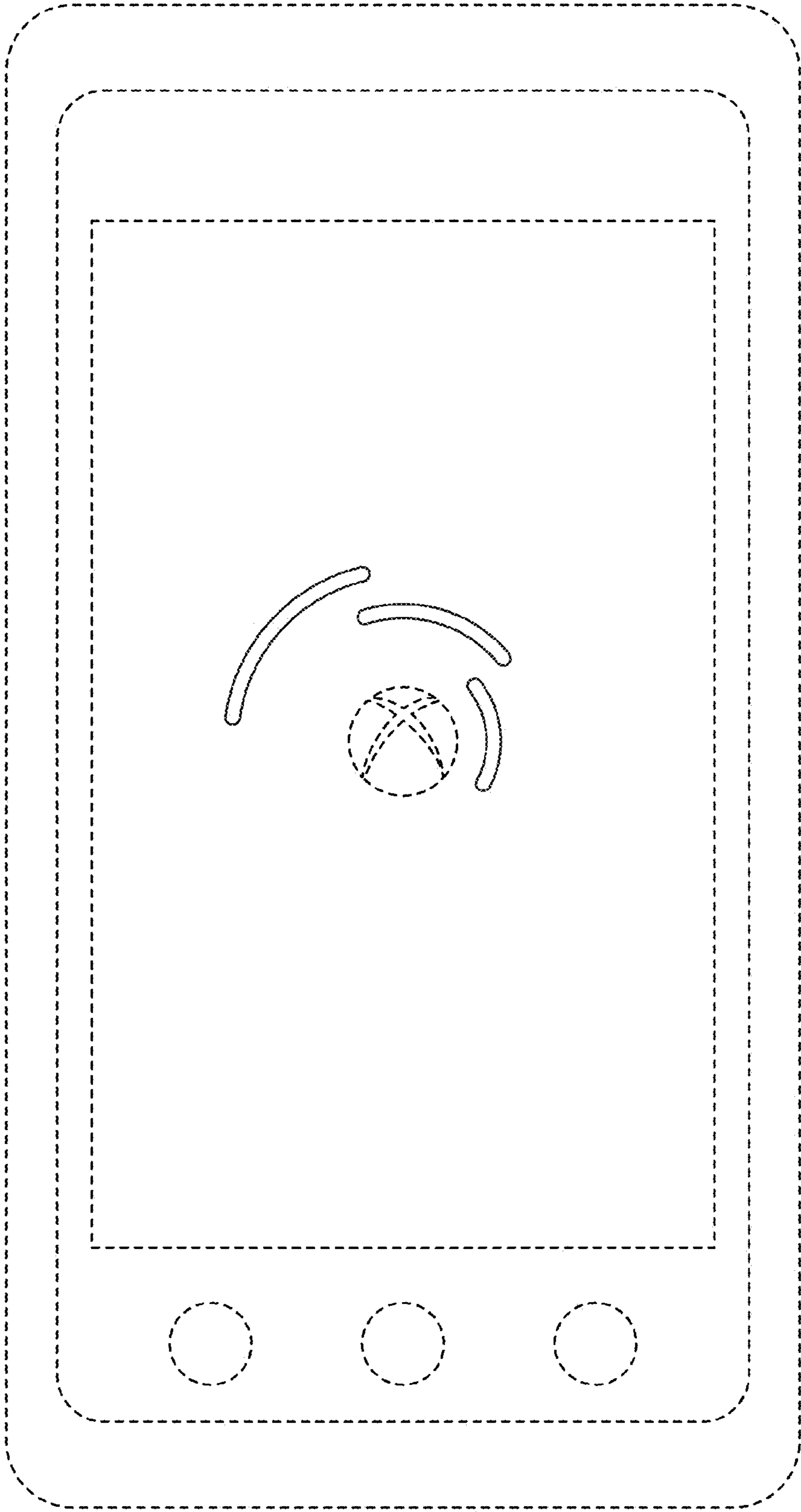

FIG. 10

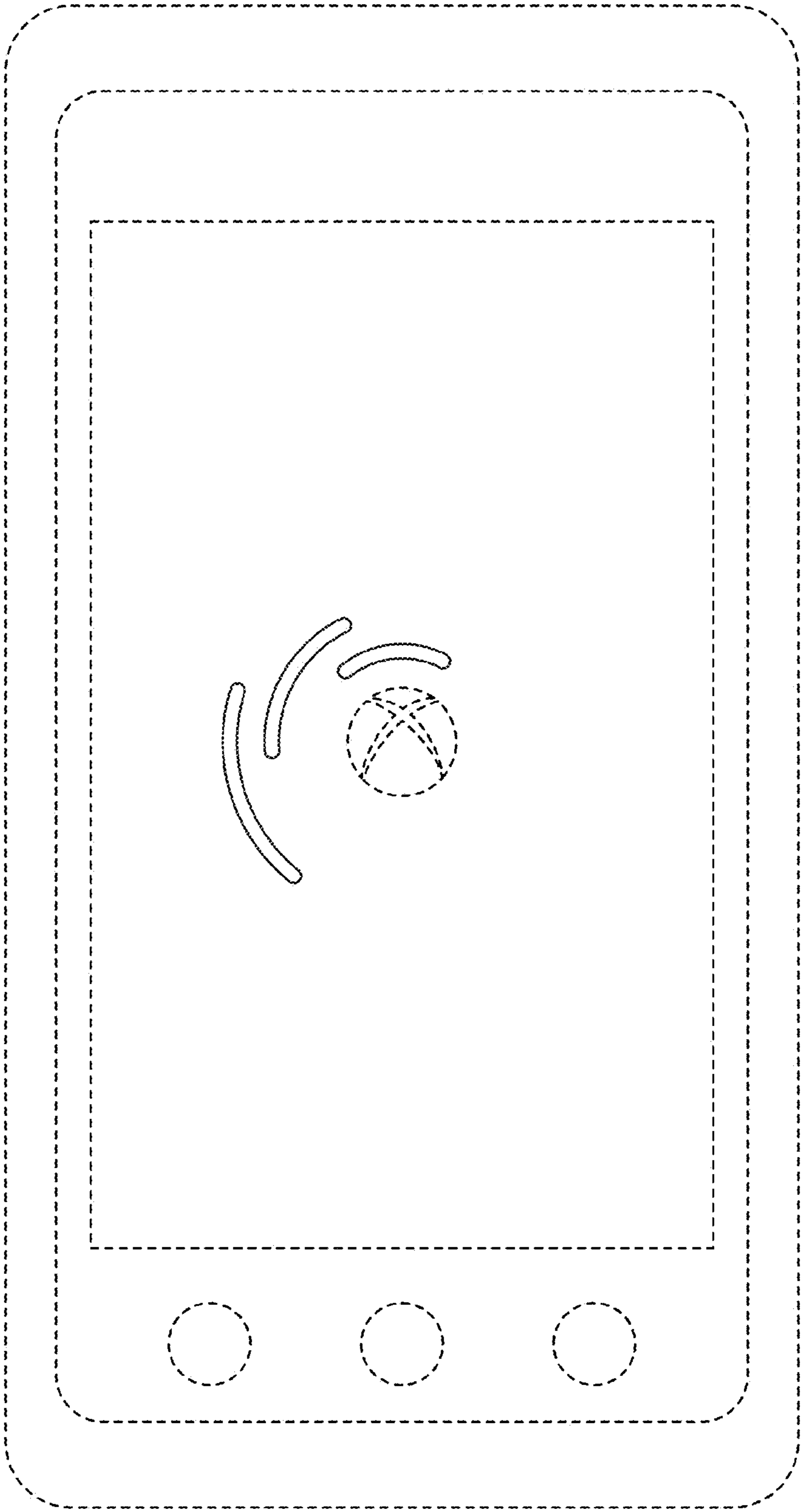

FIG. 11

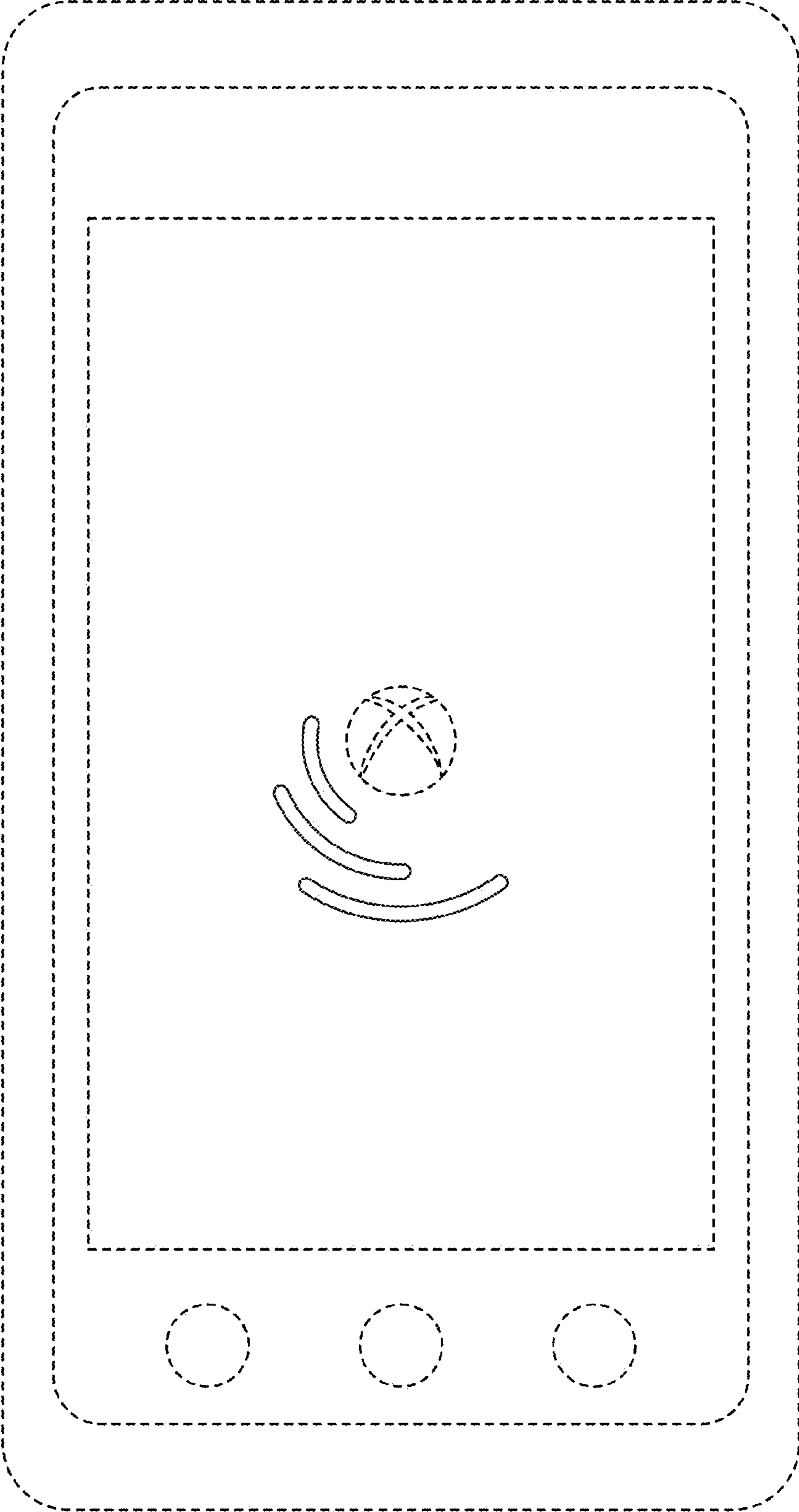

FIG. 12

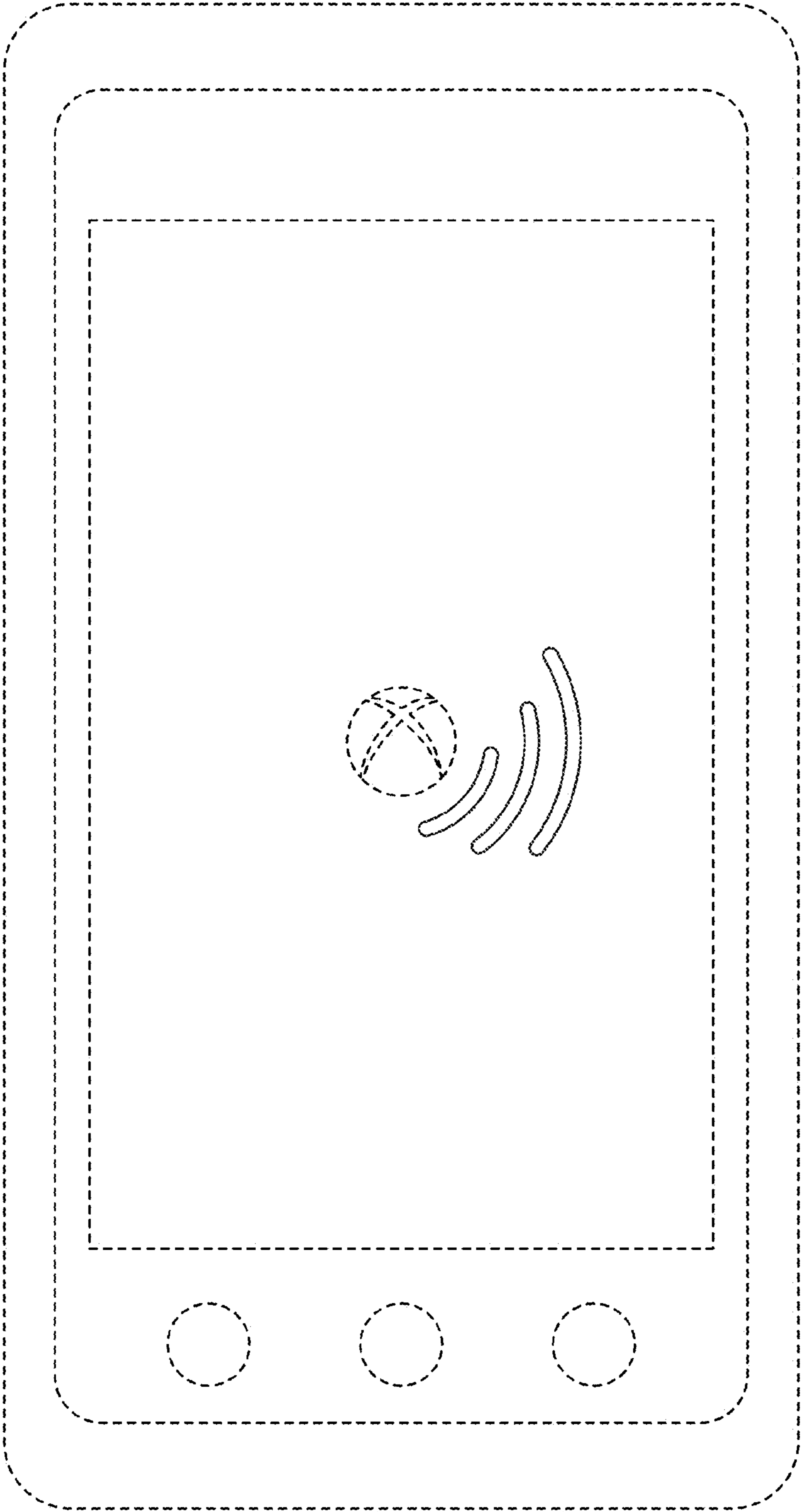

FIG. 13

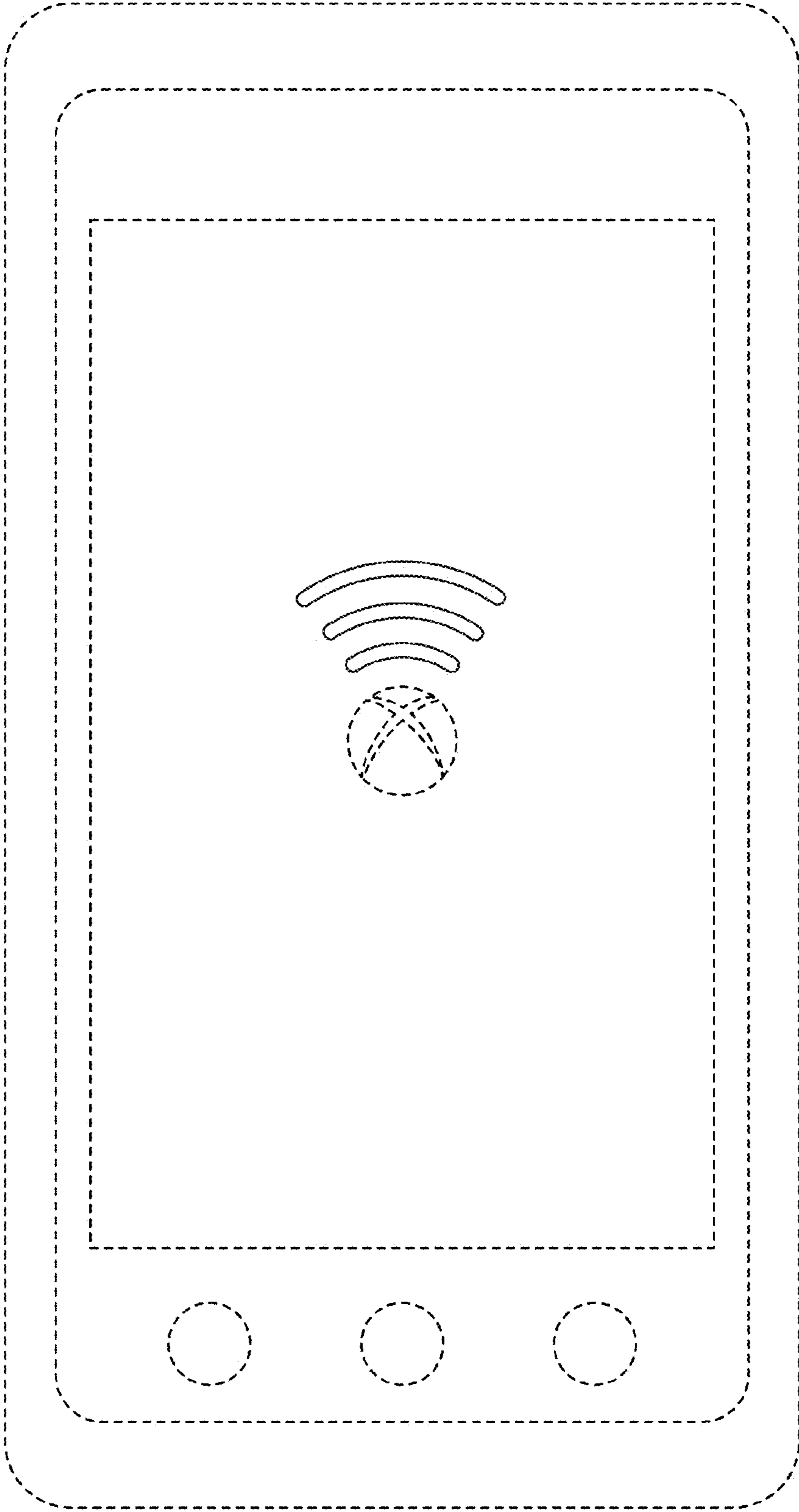

FIG. 14

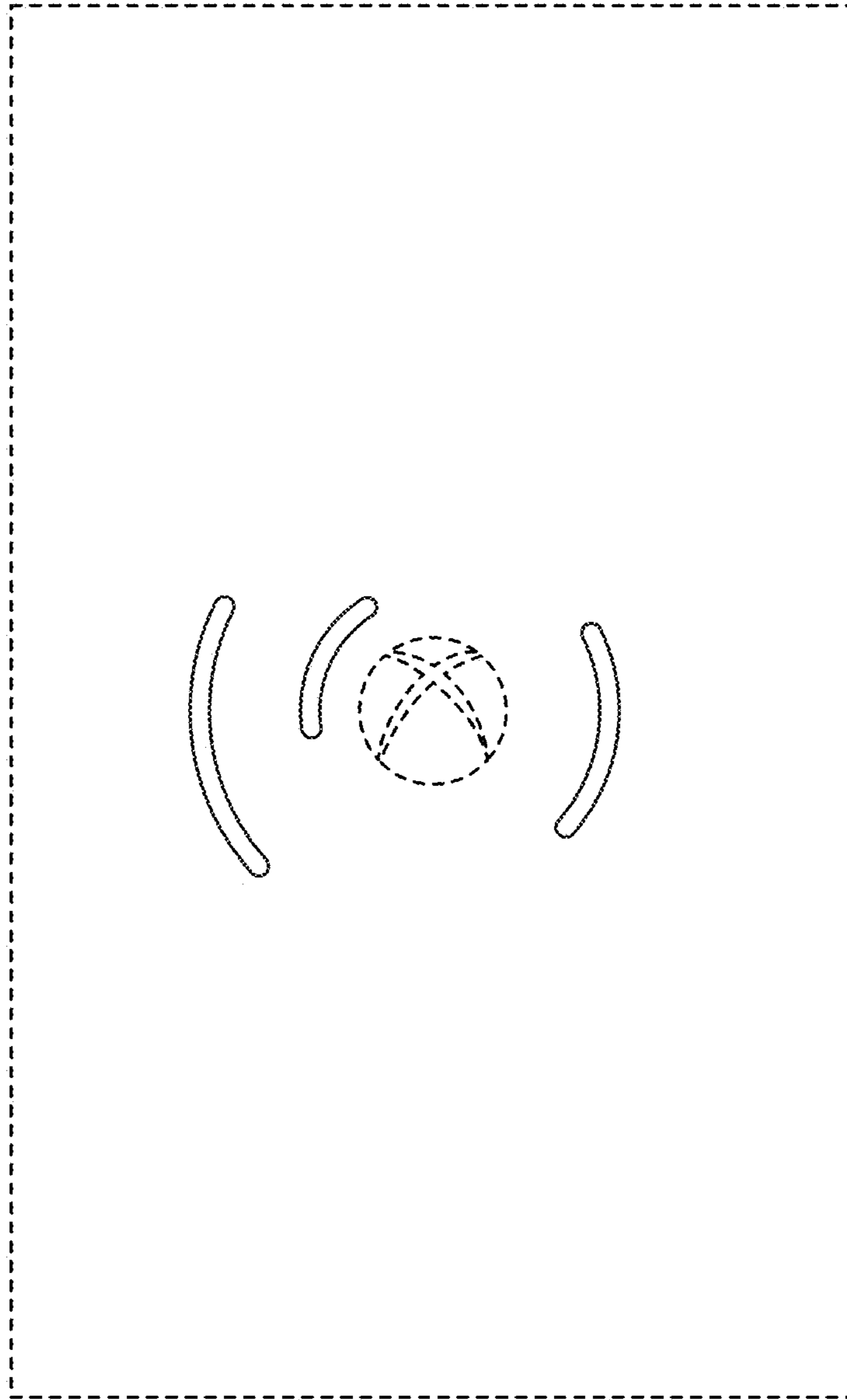

FIG. 15

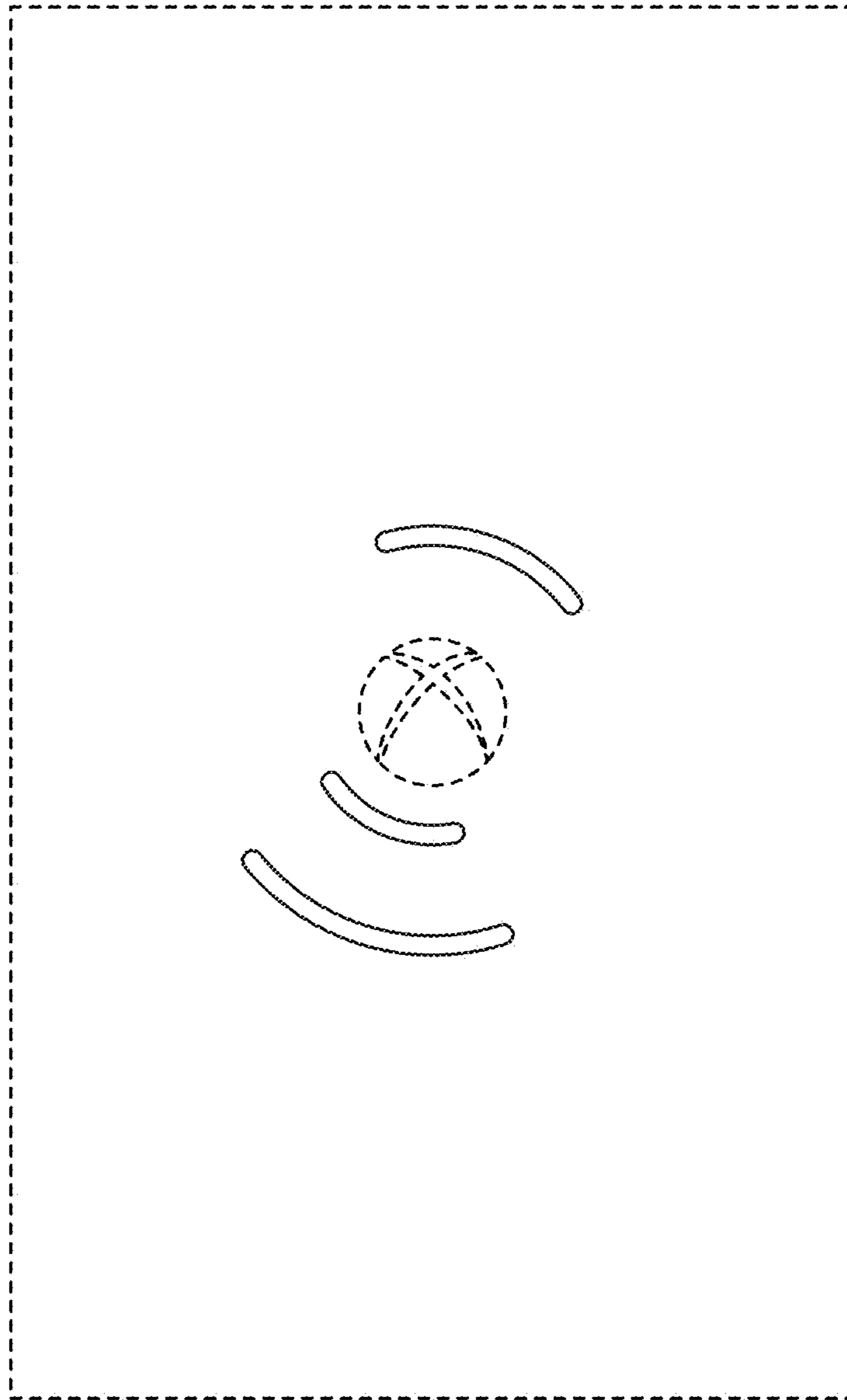

FIG. 16

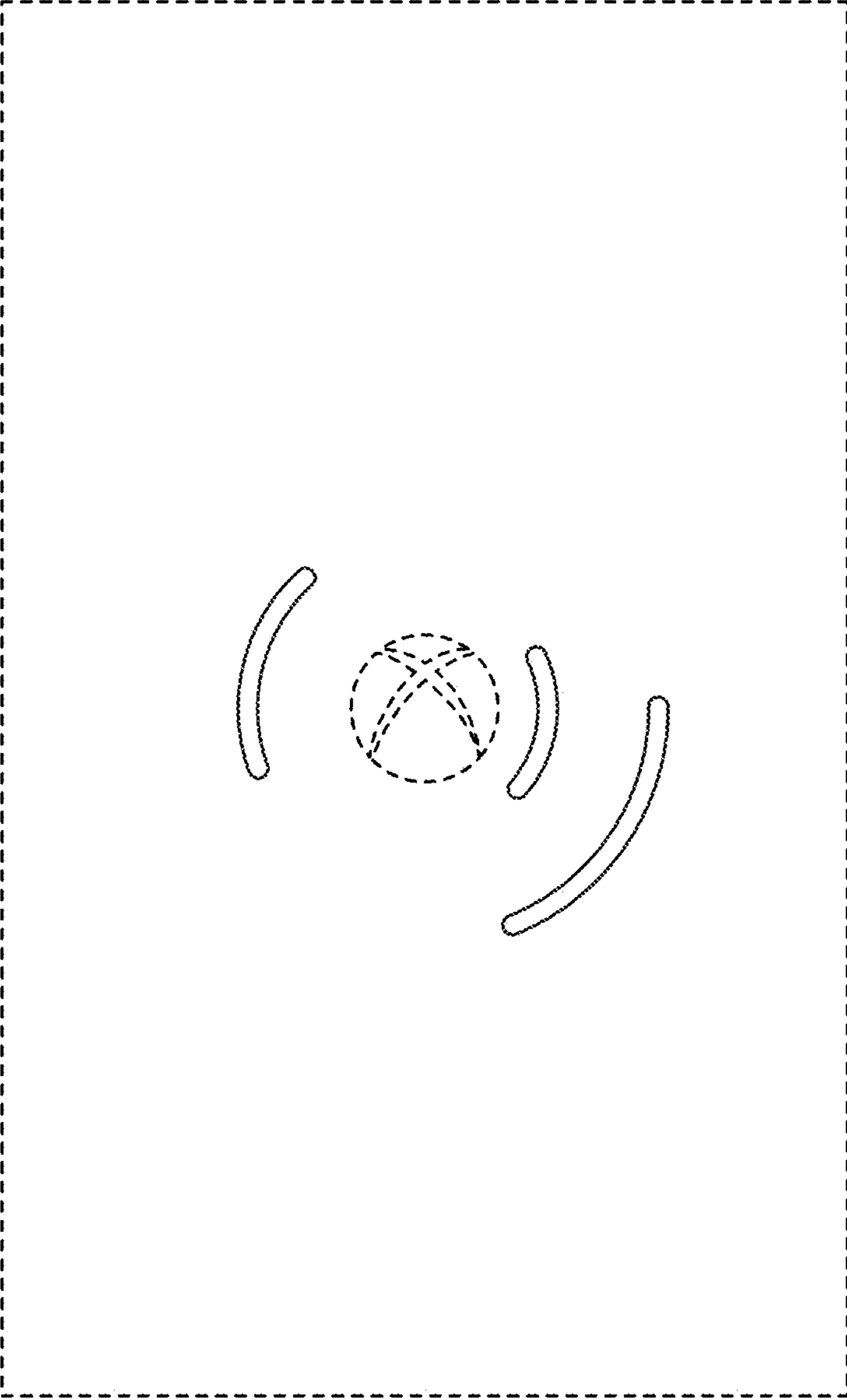

FIG. 17

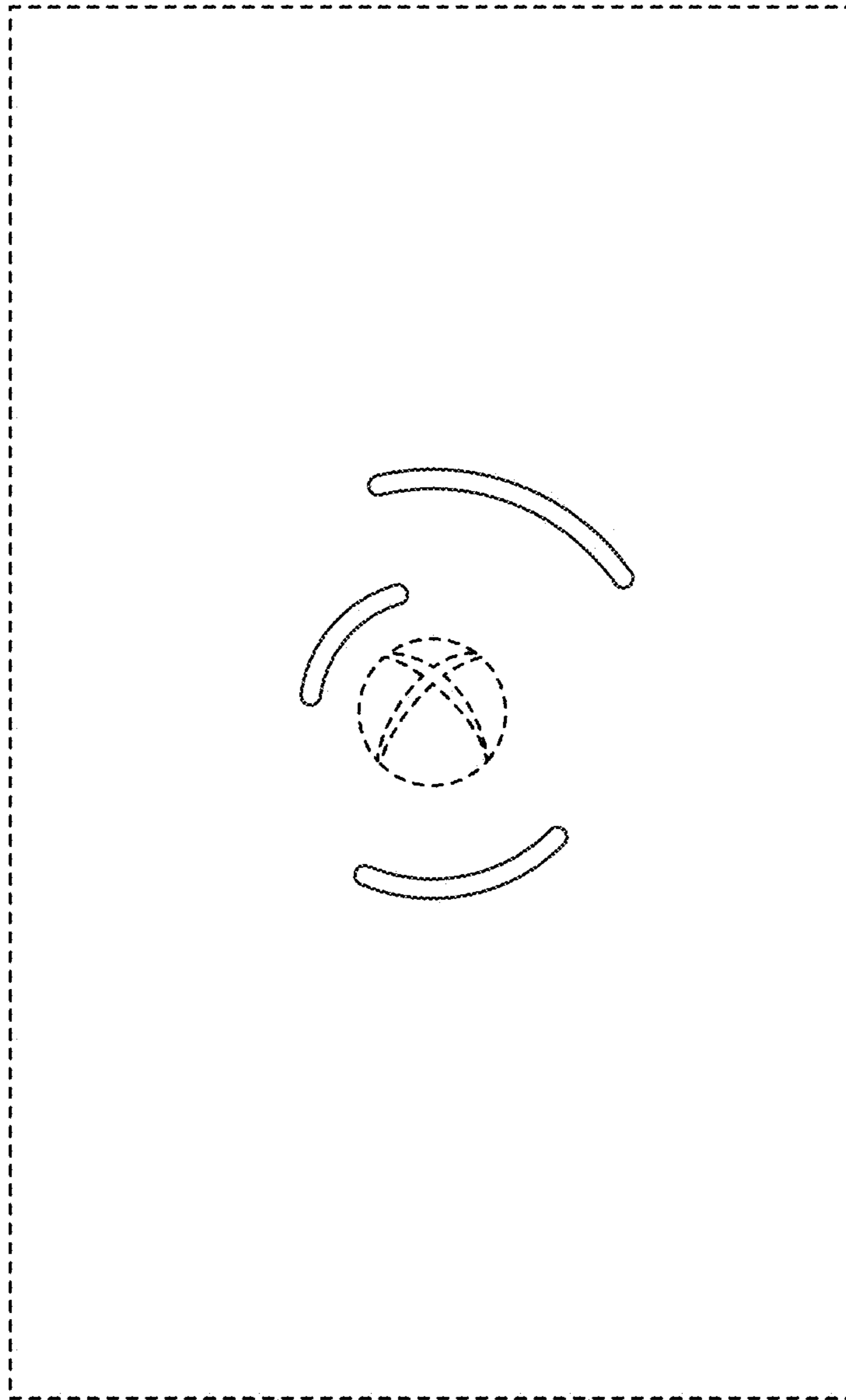

FIG. 18

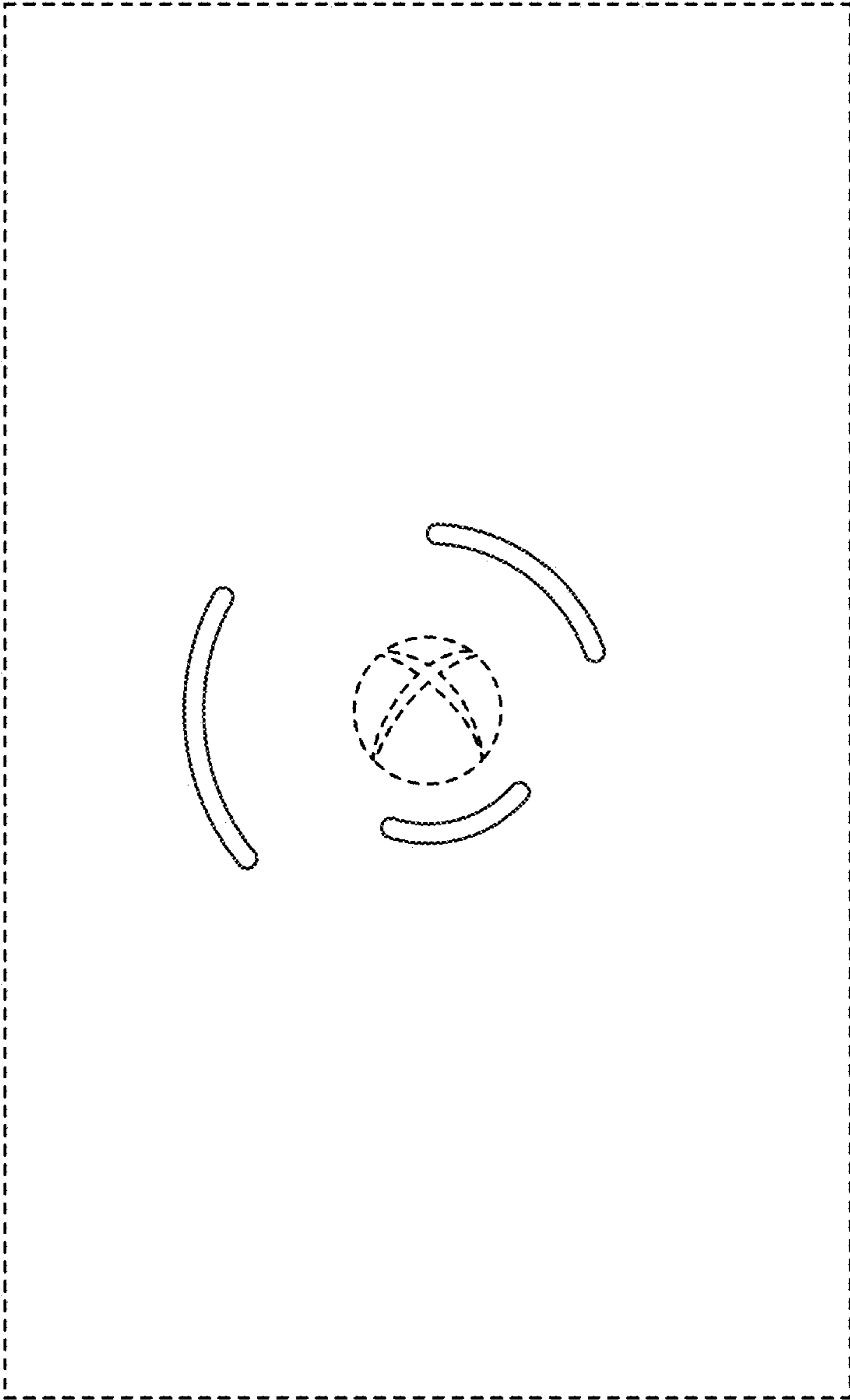

FIG. 19

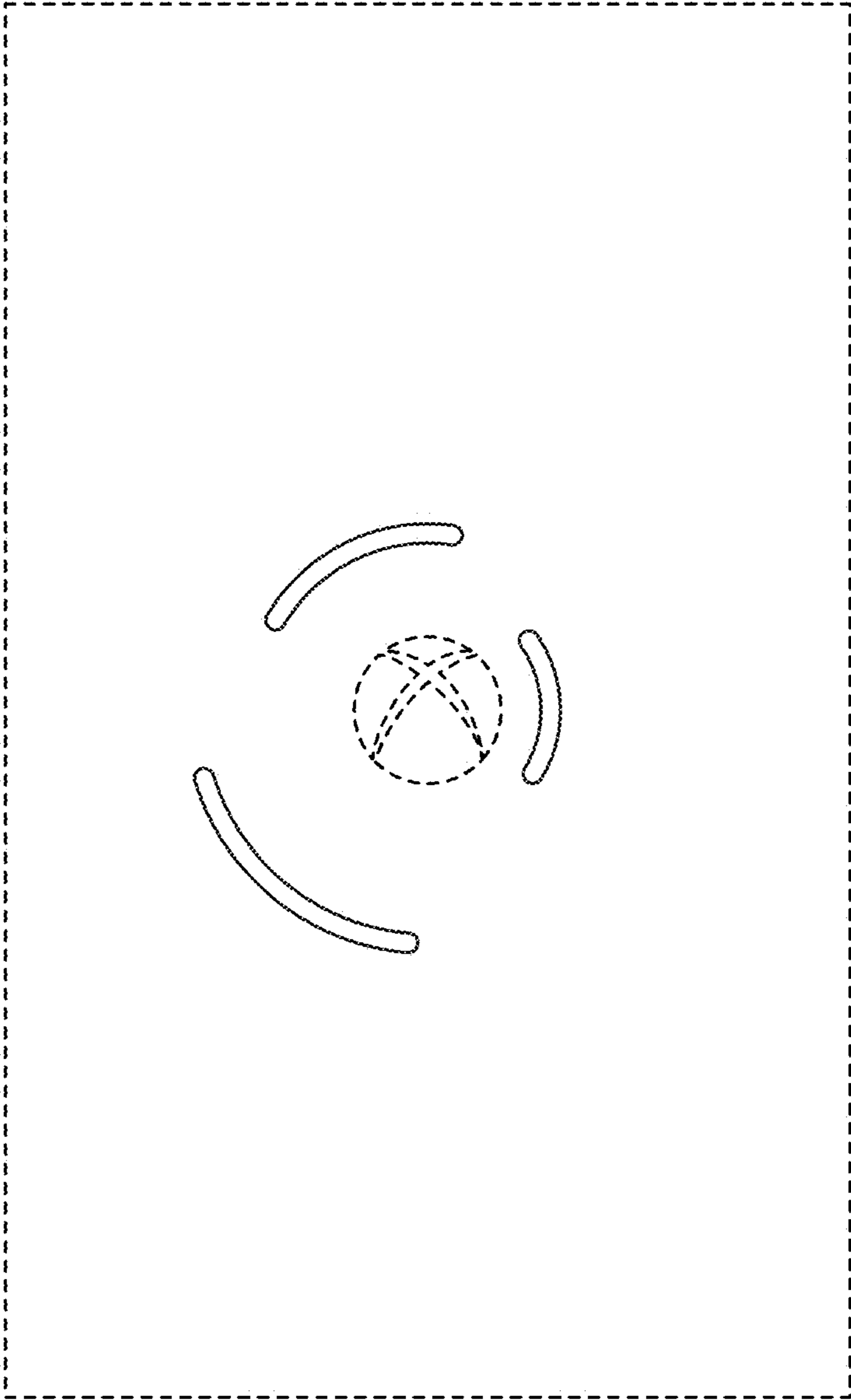

FIG. 20

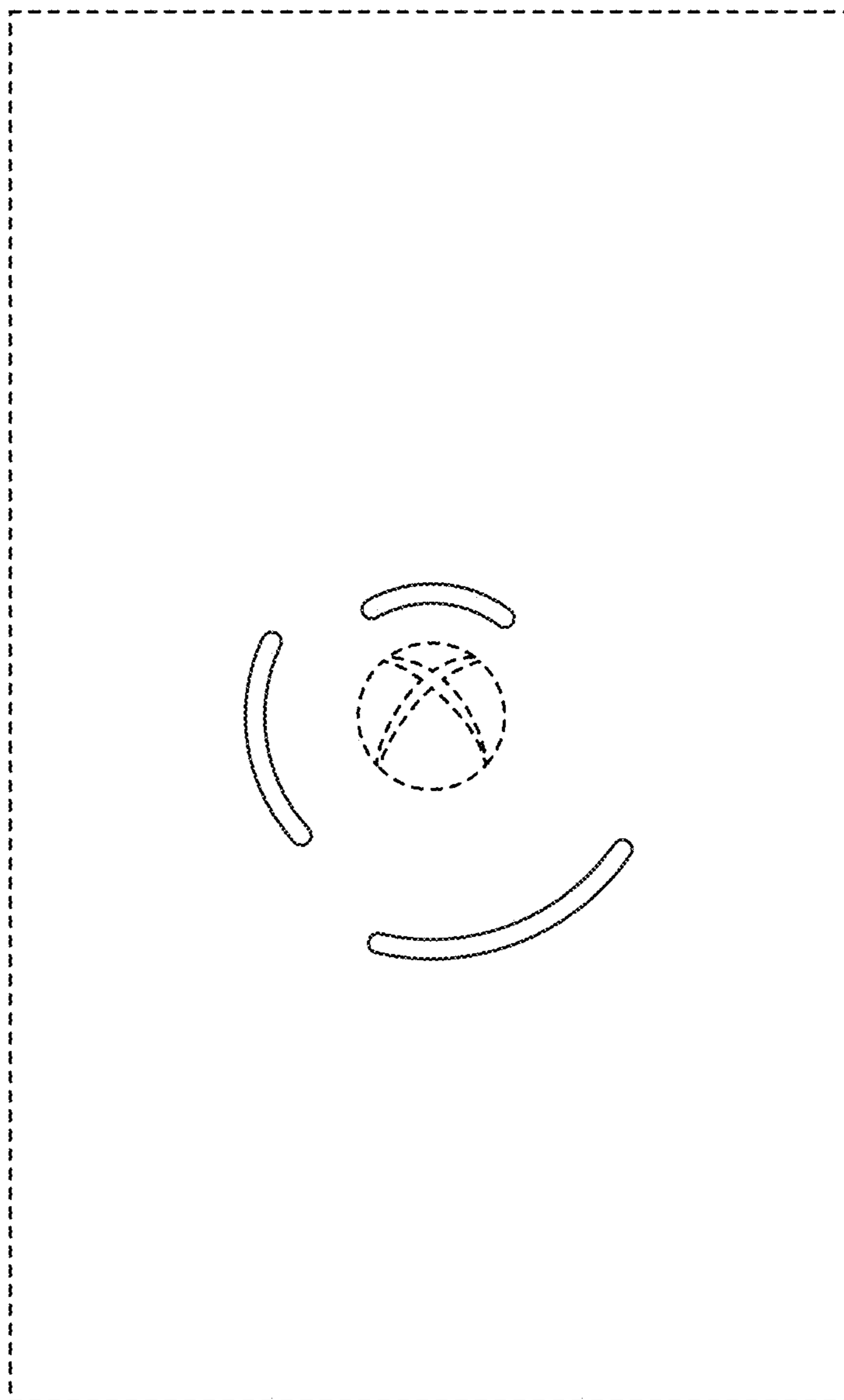

FIG. 21

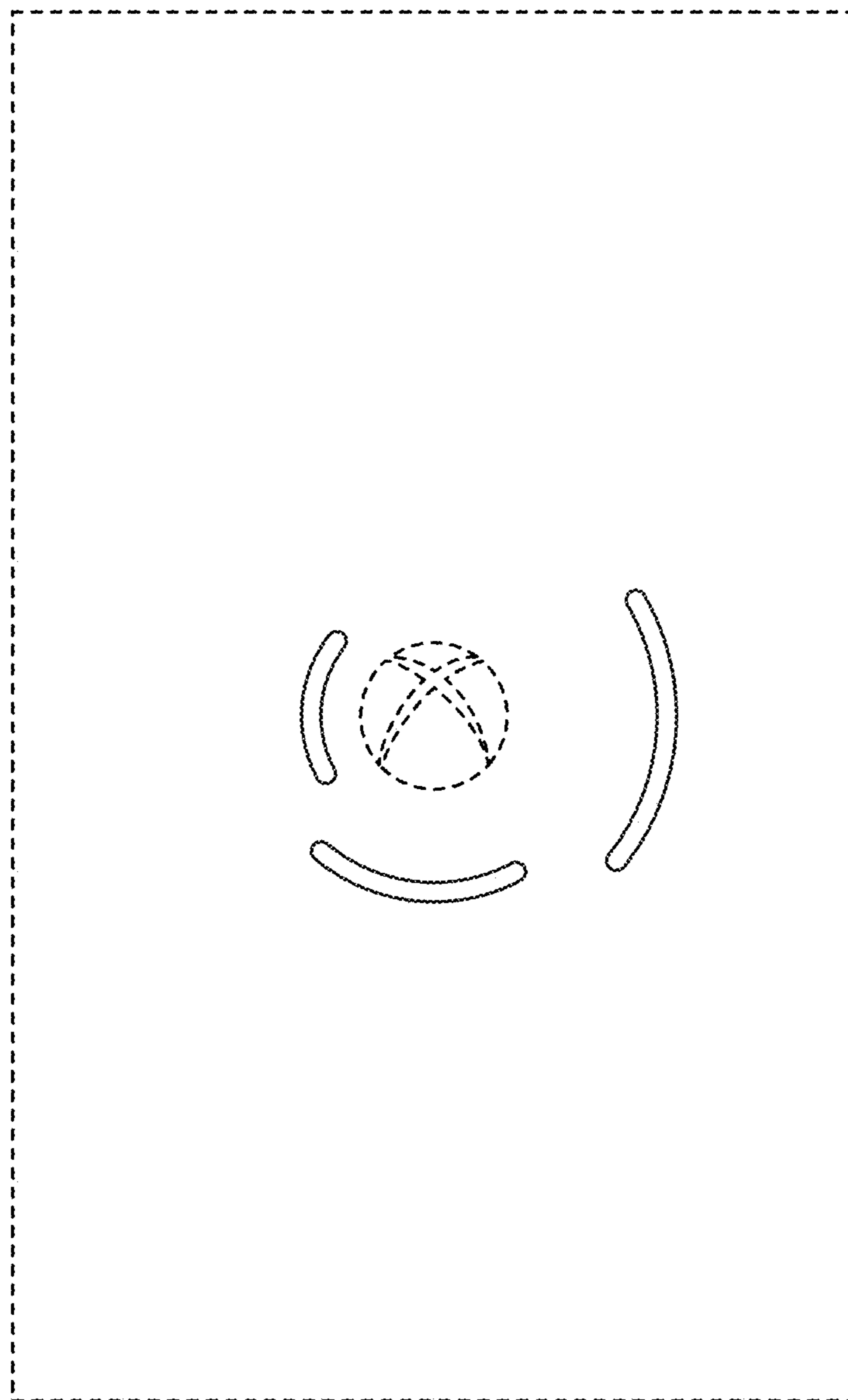

FIG. 22

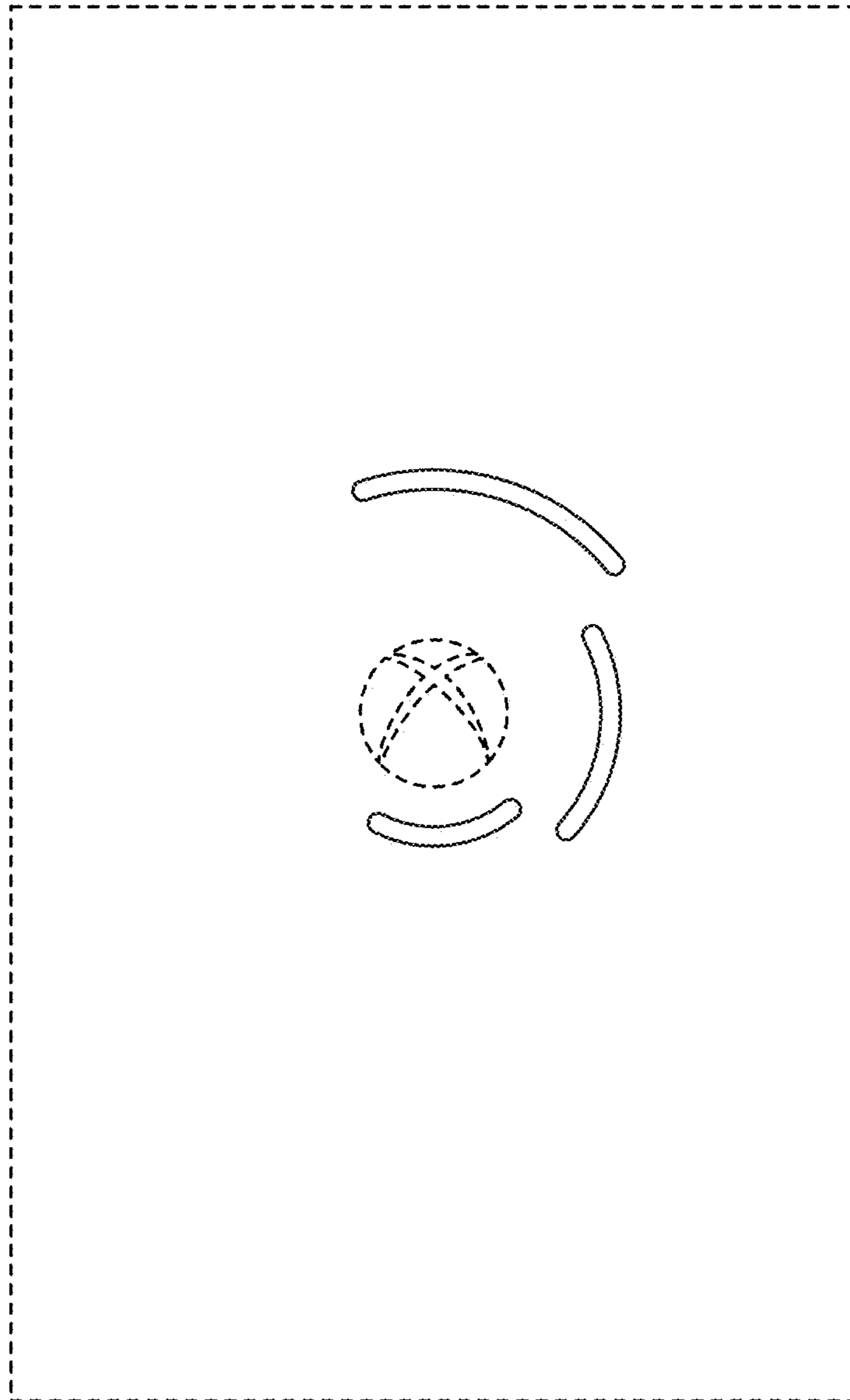

FIG. 23

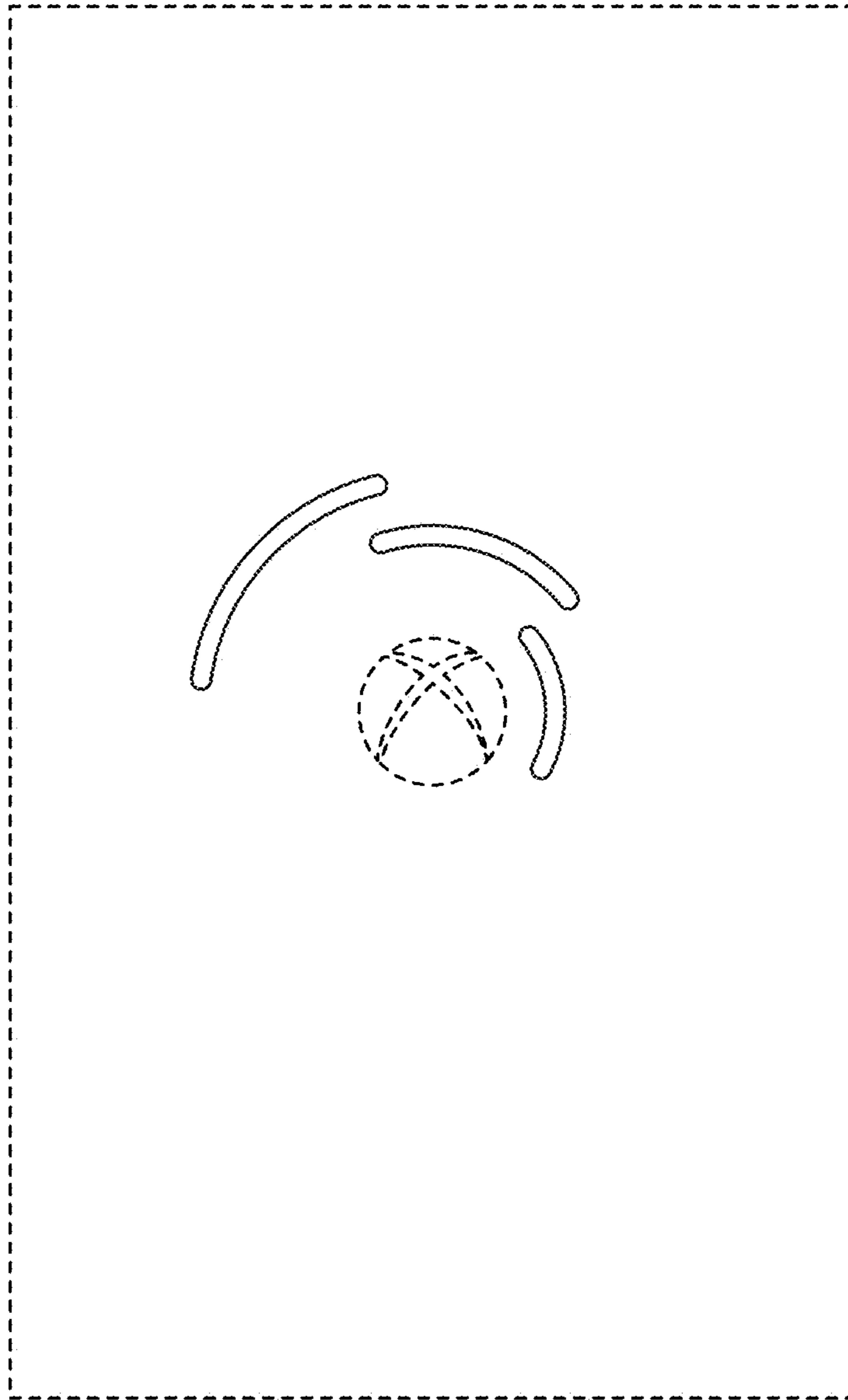

FIG. 24

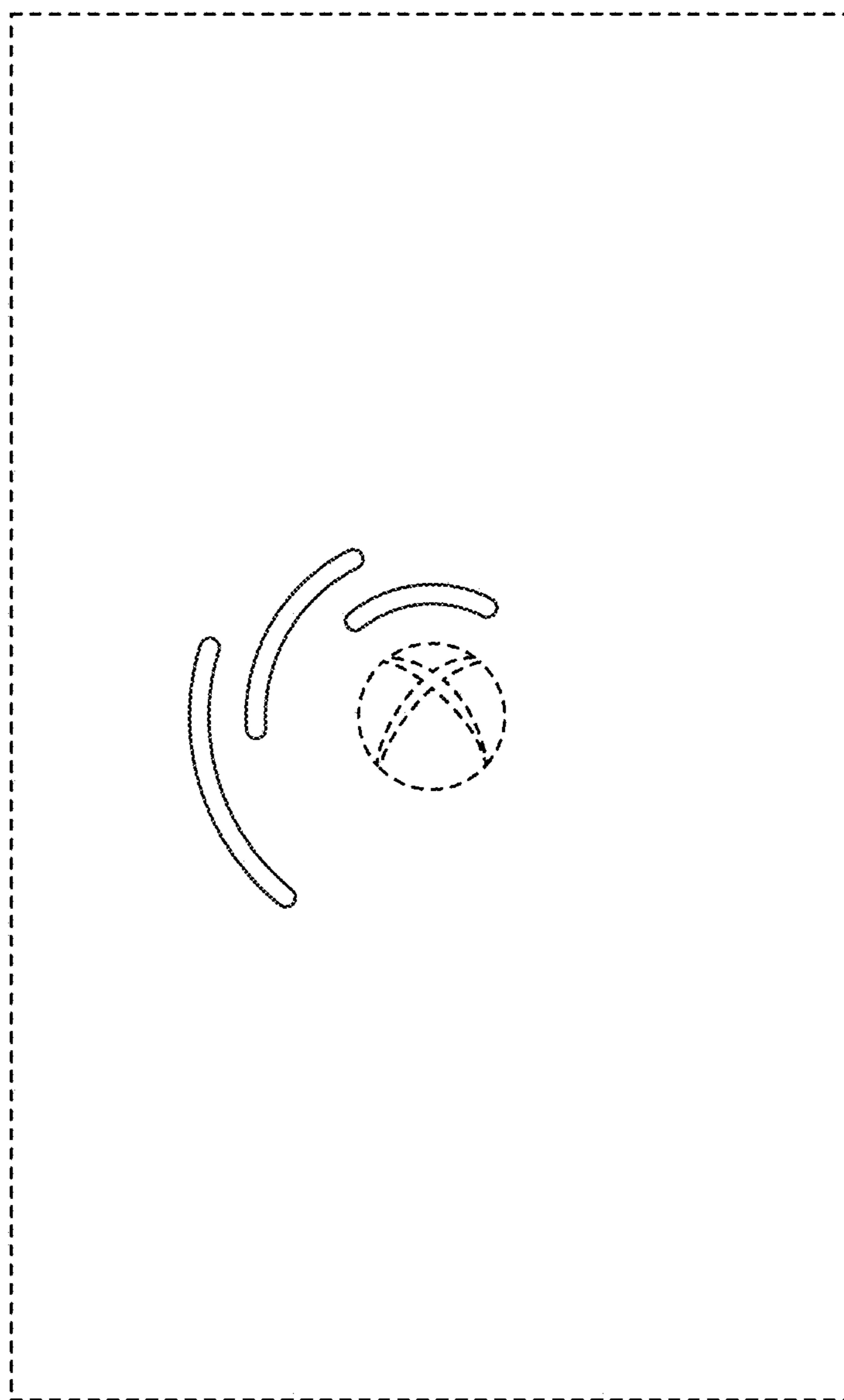

FIG. 25

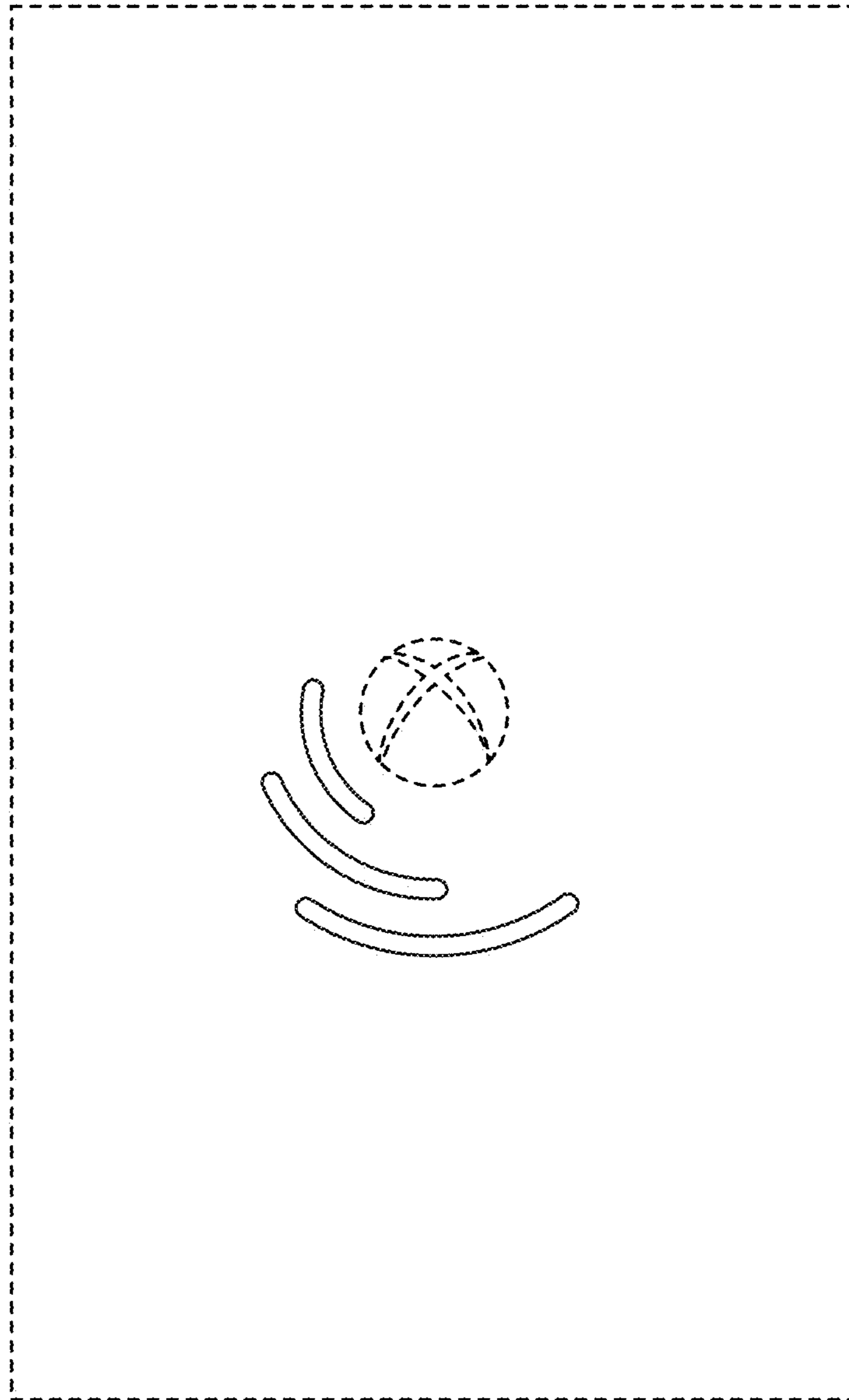

FIG. 26

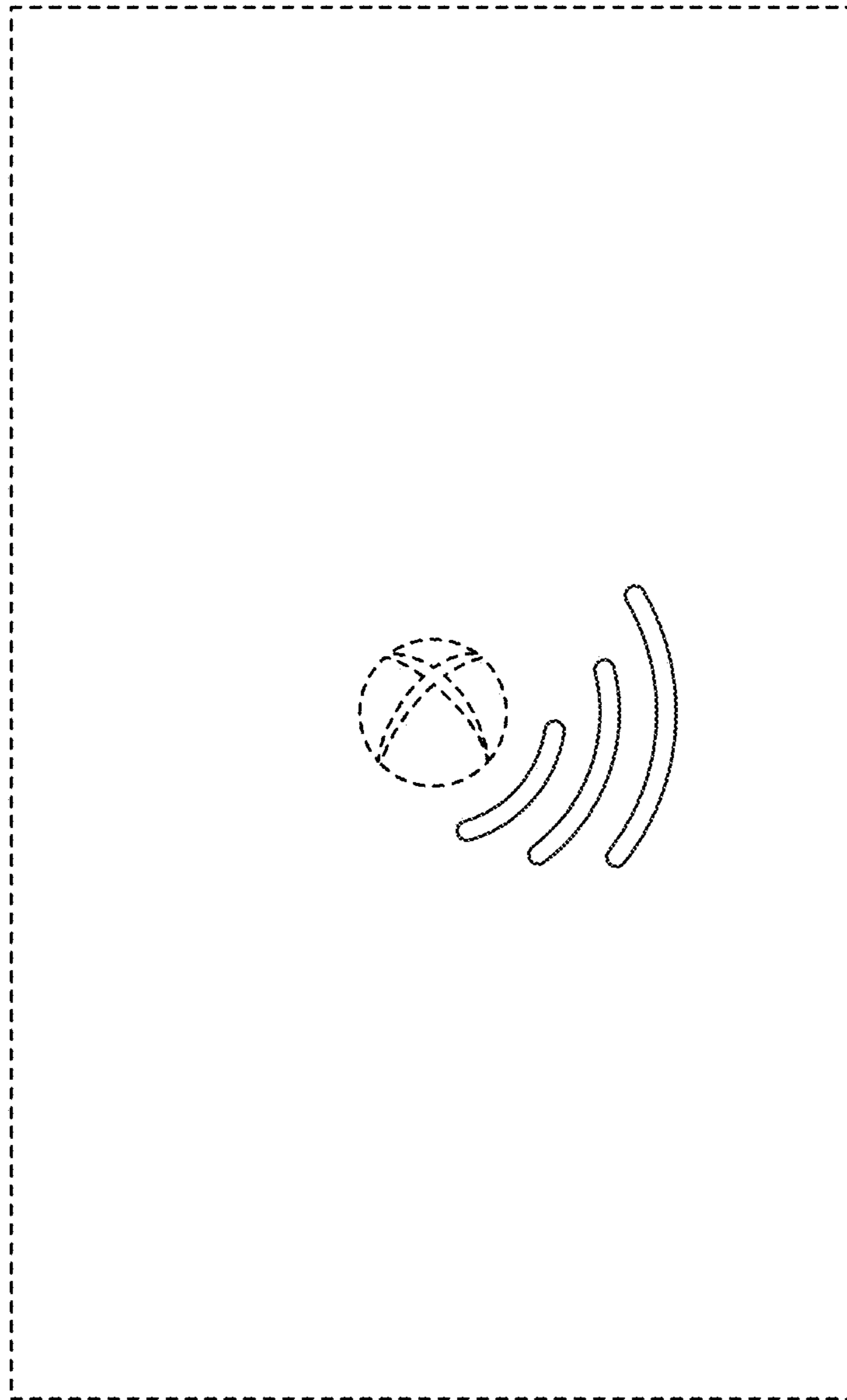

FIG. 27

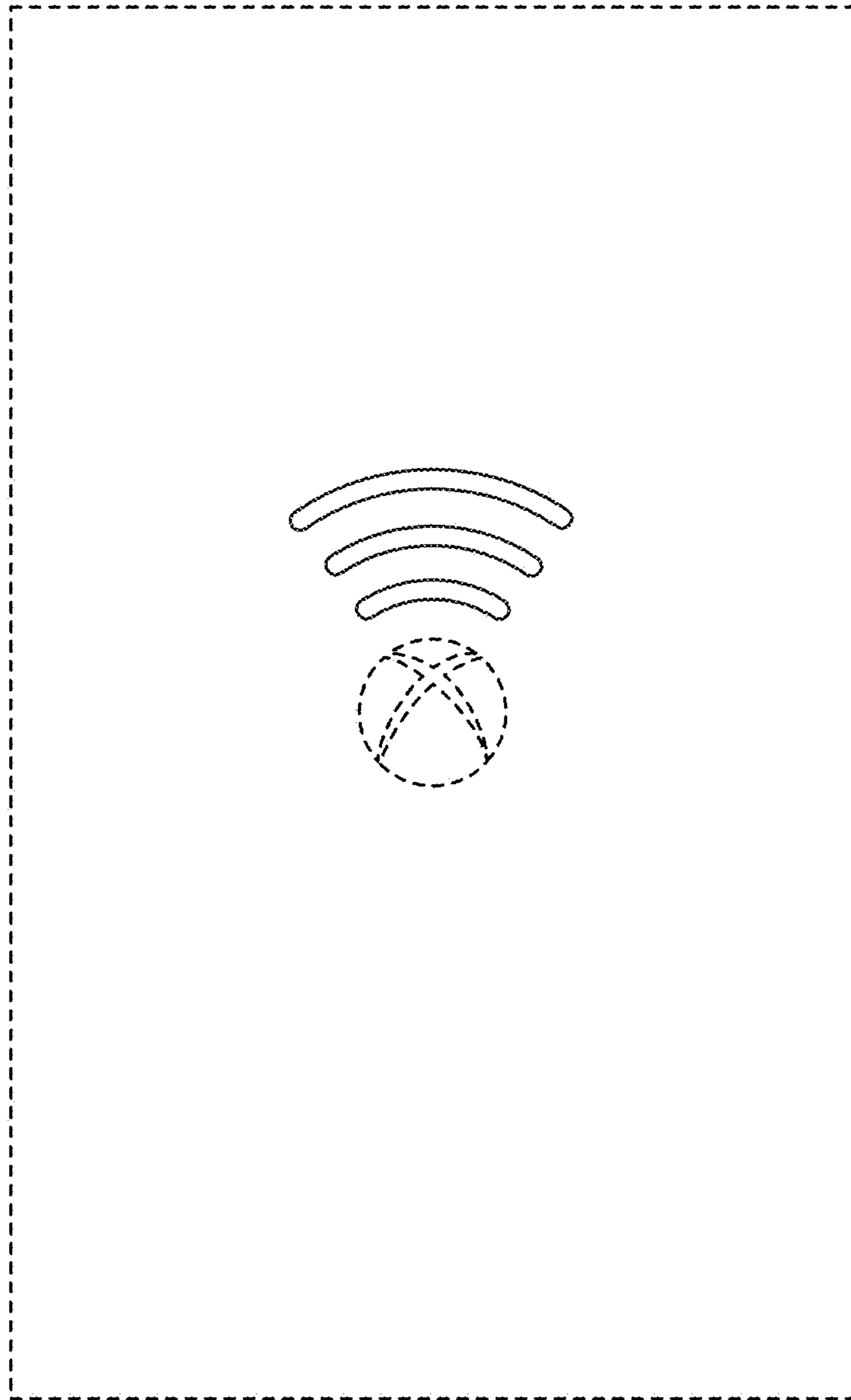

FIG. 28