



US00D709878S

(12) **United States Design Patent**  
**Akana et al.**

(10) **Patent No.:** **US D709,878 S**  
(45) **Date of Patent:** **\*\* Jul. 29, 2014**

(54) **DISPLAY**

(75) Inventors: **Jody Akana**, San Francisco, CA (US); **Bartley K. Andre**, Menlo Park, CA (US); **Jeremy Bataillou**, San Francisco, CA (US); **Daniel J. Coster**, San Francisco, CA (US); **Laura Michelle Deforest**, San Mateo, CA (US); **Daniele De Iuliis**, San Francisco, CA (US); **Adam Terence Garelli**, San Jose, CA (US); **Joss Giddings**, San Francisco, CA (US); **Bradley Joseph Hamel**, Redwood City, CA (US); **M. Evans Hankey**, San Francisco, CA (US); **Keith Hendren**, San Francisco, CA (US); **Julian Hoenig**, San Francisco, CA (US); **Richard P. Howarth**, San Francisco, CA (US); **Jonathan P. Ive**, San Francisco, CA (US); **Duncan Robert Kerr**, San Francisco, CA (US); **Dinesh Cherian Mathew**, San Francisco, CA (US); **Bryan William Posner**, La Selva Beach, CA (US); **Matthew Dean Rohrbach**, San Francisco, CA (US); **Peter Russell-Clarke**, San Francisco, CA (US); **Mikael Silvanto**, San Francisco, CA (US); **Christopher J. Stringer**, Woodside, CA (US); **Eugene Antony Whang**, San Francisco, CA (US); **Rico Zorkendorfer**, San Francisco, CA (US)

(73) Assignee: **Apple Inc.**, Cupertino, CA (US)

(\*\*) Term: **14 Years**

(21) Appl. No.: **29/424,266**

(22) Filed: **Jun. 9, 2012**

(51) **LOC (10) Cl.** ..... **14-02**

(52) **U.S. Cl.**  
USPC ..... **D14/371; D14/374**

(58) **Field of Classification Search**  
USPC ..... D14/315-327, 439, 371, 374, 375, D14/125-129; D18/1, 2, 7, 11; 235/145 A, 235/145 R; 341/22, 23; 345/104, 156, 168, 345/169, 173; 361/679.08, 679.09, 679.11, 361/679.26, 679.27; 16/367

See application file for complete search history.

(56) **References Cited**

U.S. PATENT DOCUMENTS

4,531,122 A \* 7/1985 Redfield ..... 345/74.1  
D491,177 S 6/2004 Andre et al.

(Continued)

OTHER PUBLICATIONS

Apple MacBook Air, available Jan. 15, 2008 <[http://images.apple.com/macbookair/images/design\\_displayair20080115.jpg](http://images.apple.com/macbookair/images/design_displayair20080115.jpg)>.

(Continued)

*Primary Examiner* — Freda S Nunn

(74) *Attorney, Agent, or Firm* — SAIDMAN DesignLaw Group

(57) **CLAIM**

The ornamental design for a display, as shown and described.

**DESCRIPTION**

FIG. 1 is a top perspective view of a first embodiment of a display showing our new design; FIG. 2 is a bottom perspective view thereof; FIG. 3 is top view thereof; FIG. 4 is a bottom view thereof; FIG. 5 is a front view thereof; FIG. 6 is a rear view thereof; FIG. 7 is a left view thereof; FIG. 8 is a right view thereof; FIG. 9 is a top perspective view of a second embodiment thereof; FIG. 10 is a bottom perspective view thereof; FIG. 11 is top view thereof; FIG. 12 is a bottom view thereof; FIG. 13 is a front view thereof; FIG. 14 is a rear view thereof; FIG. 15 is a left view thereof; and, FIG. 16 is a right view thereof.

The broken lines are for the purpose of illustrating portions of the electronic device and form no part of the claimed design. The light shade lines on the surface portions indicate contour and not surface decoration.

**1 Claim, 12 Drawing Sheets**

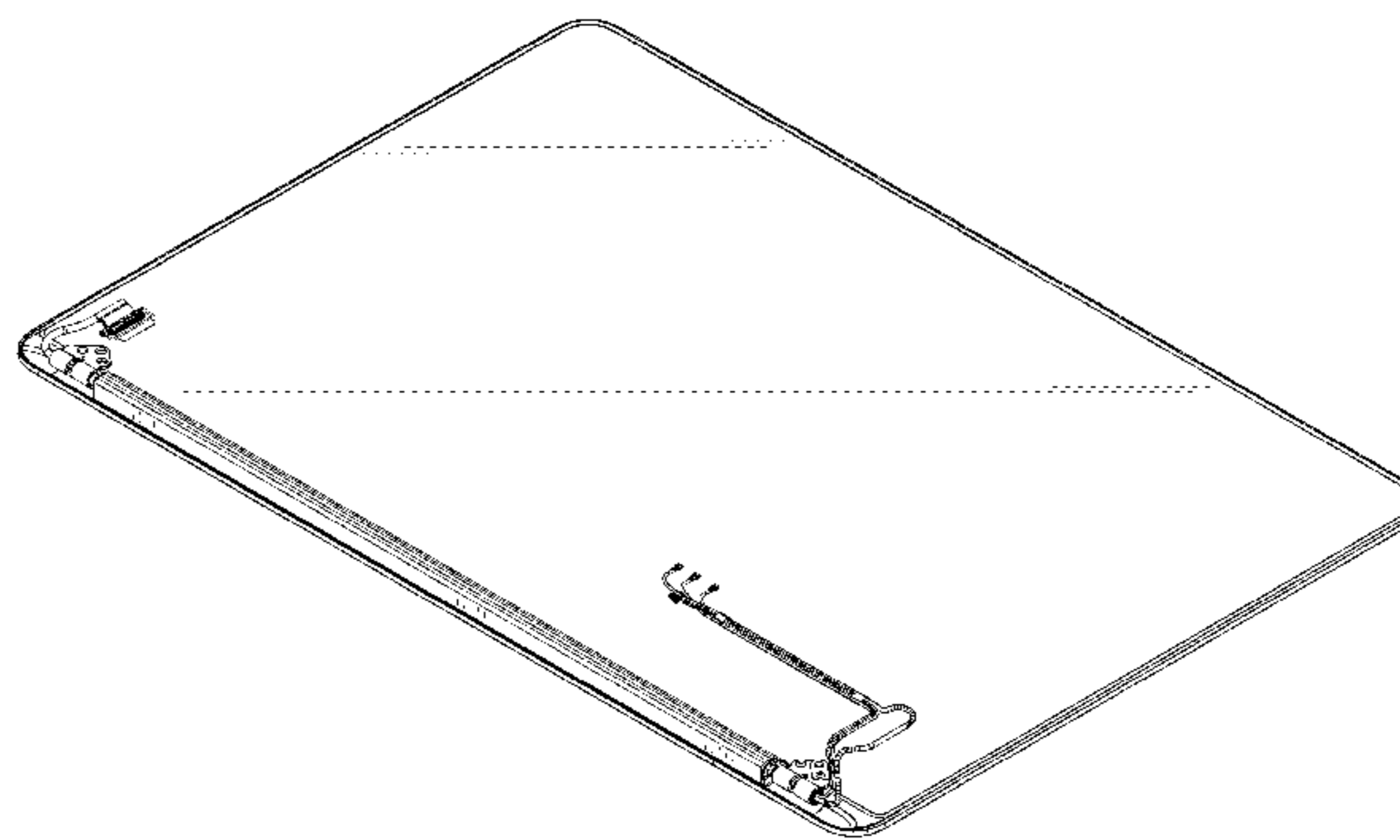
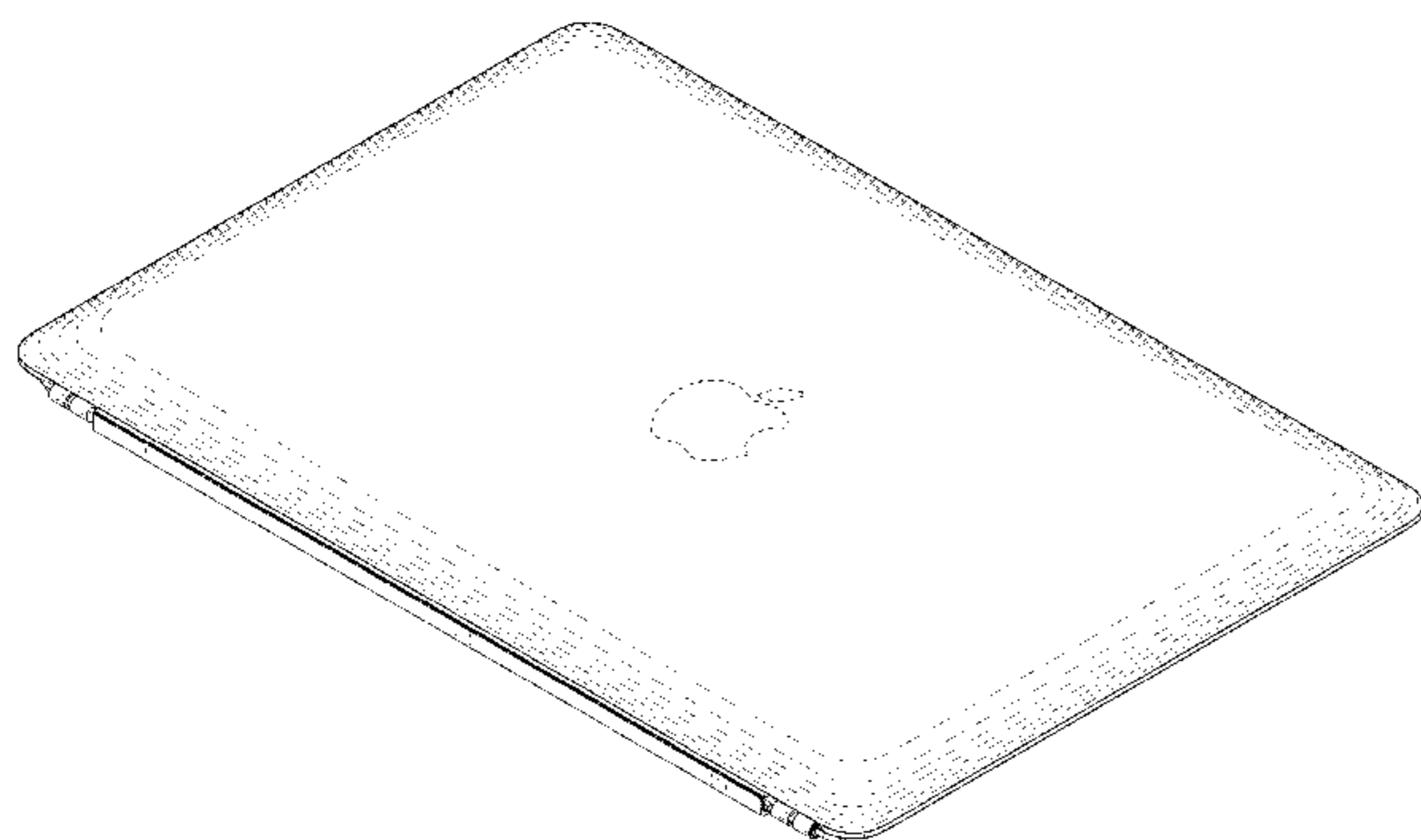

(56)

**References Cited**

U.S. PATENT DOCUMENTS

6,785,128 B1 \* 8/2004 Yun ..... 361/679.27  
 D506,752 S \* 6/2005 Huh ..... D14/316  
 D517,063 S \* 3/2006 Nakajima et al. .... D14/318  
 D558,753 S 1/2008 Andre et al.  
 D600,688 S 9/2009 Andre et al.  
 D604,289 S 11/2009 Andre et al.  
 D604,290 S 11/2009 Andre et al.  
 D604,291 S 11/2009 Andre et al.  
 D604,292 S 11/2009 Andre et al.  
 D606,989 S 12/2009 Andre et al.  
 D607,450 S 1/2010 Morishita et al.  
 D611,469 S 3/2010 Andre et al.  
 D621,824 S 8/2010 Andre et al.  
 D637,596 S 5/2011 Akana et al.  
 D642,172 S 7/2011 Akana et al.  
 D642,560 S 8/2011 Akana et al.  
 D648,334 S \* 11/2011 Andre et al. .... D14/315  
 8,149,222 B2 \* 4/2012 Hsieh et al. .... 345/173  
 D676,438 S 2/2013 Akana et al.  
 D686,205 S 7/2013 Akana et al.  
 2005/0041378 A1 \* 2/2005 Hamada et al. .... 361/680

2006/0262496 A1 11/2006 Lee  
 2008/0285216 A1 11/2008 Kobayashi et al.  
 2008/0298002 A1 \* 12/2008 Liu et al. .... 361/681  
 2009/0067125 A1 \* 3/2009 Xia et al. .... 361/679.27

OTHER PUBLICATIONS

Apple MacBook Air, available Jan. 15, 2008 <[http://images.apple.com/macbookair/images/design\\_galo1\\_20080115.jpg](http://images.apple.com/macbookair/images/design_galo1_20080115.jpg)>.  
 Apple MacBook Air, available Jan. 15, 2008 <[http://images.apple.com/macbookair/images/design\\_galo2\\_20080115.jpg](http://images.apple.com/macbookair/images/design_galo2_20080115.jpg)>.  
 Apple MacBook Air, available Jan. 15, 2008 <[http://images.apple.com/macbookair/images/design\\_galo3\\_20080115.jpg](http://images.apple.com/macbookair/images/design_galo3_20080115.jpg)>.  
 Apple MacBook Air, available Jan. 15, 2008 <[http://images.apple.com/macbookair/images/design\\_galo4\\_20080115.jpg](http://images.apple.com/macbookair/images/design_galo4_20080115.jpg)>.  
 Apple MacBook Air, available Jan. 15, 2008 <[http://images.apple.com/macbookair/images/design\\_galo8\\_20080115.jpg](http://images.apple.com/macbookair/images/design_galo8_20080115.jpg)>.  
 Apple MacBook Air, available Jan. 15, 2008 <[http://images.apple.com/macbookair/images/design\\_keyboardair20080115.jpg](http://images.apple.com/macbookair/images/design_keyboardair20080115.jpg)>.  
 Apple MacBook Air, available Jan. 15, 2008 <[http://images.apple.com/macbookair/images/design\\_thinair20080115.jpg](http://images.apple.com/macbookair/images/design_thinair20080115.jpg)>.

\* cited by examiner

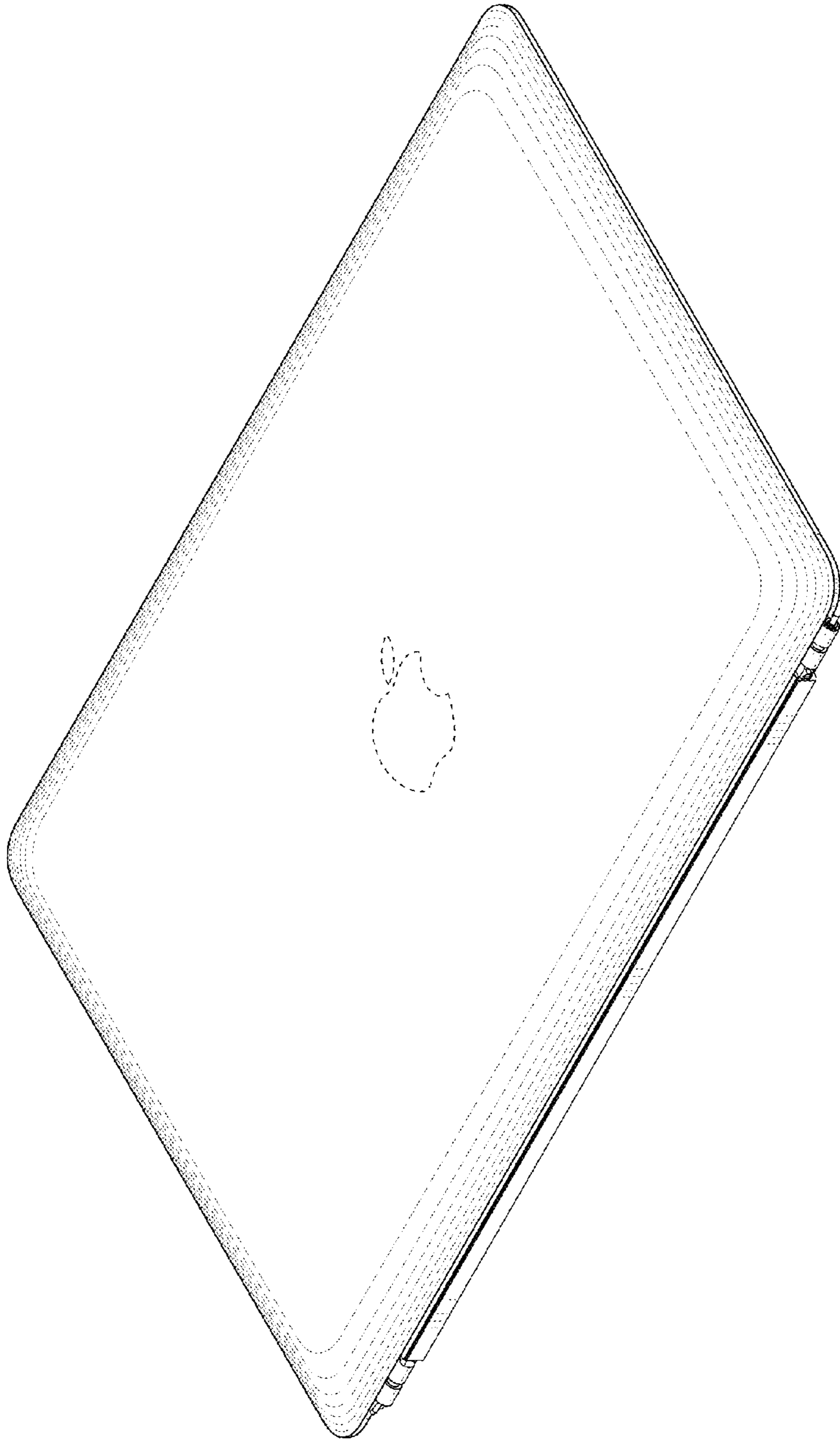

FIG. 1

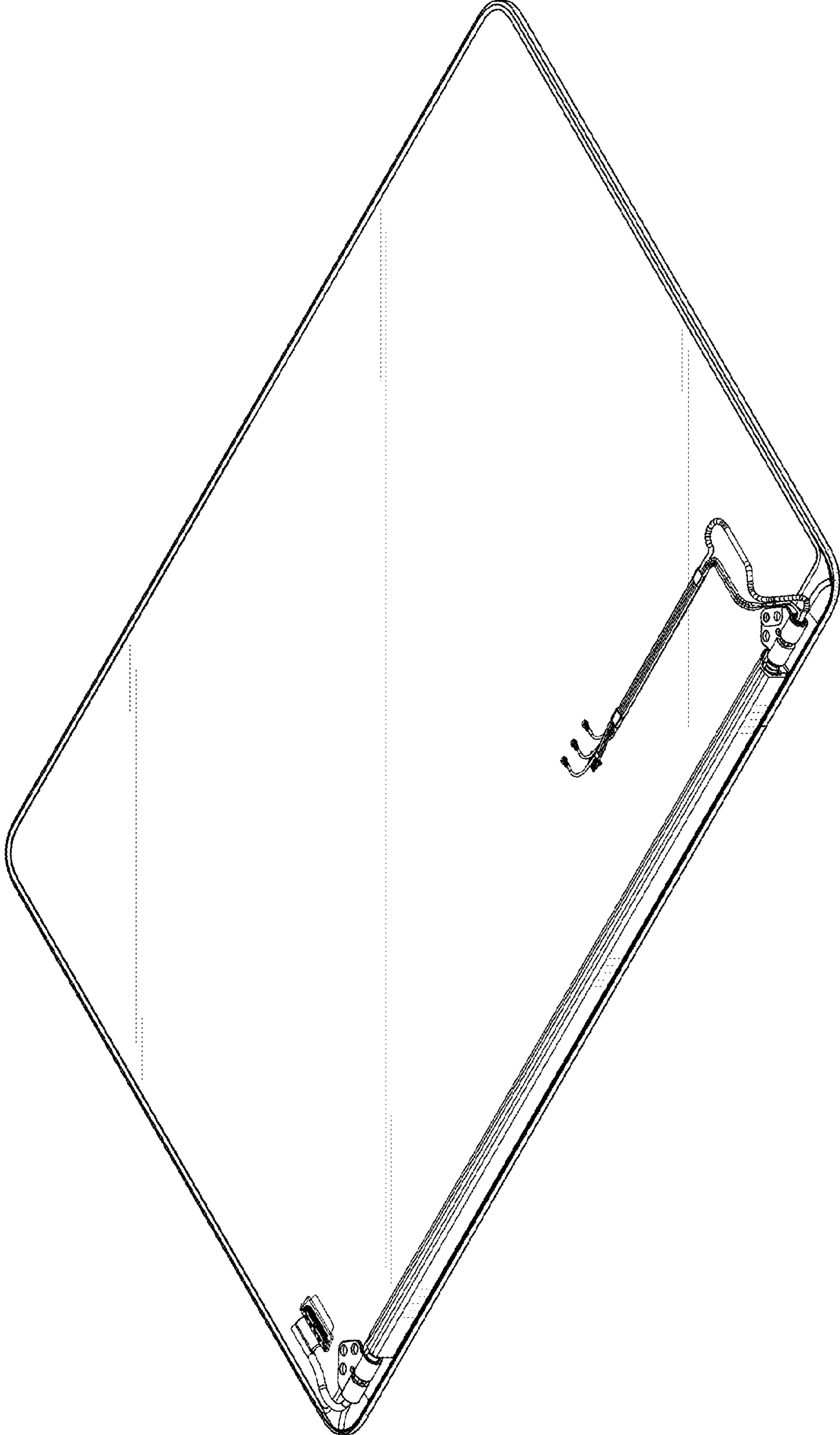

FIG. 2

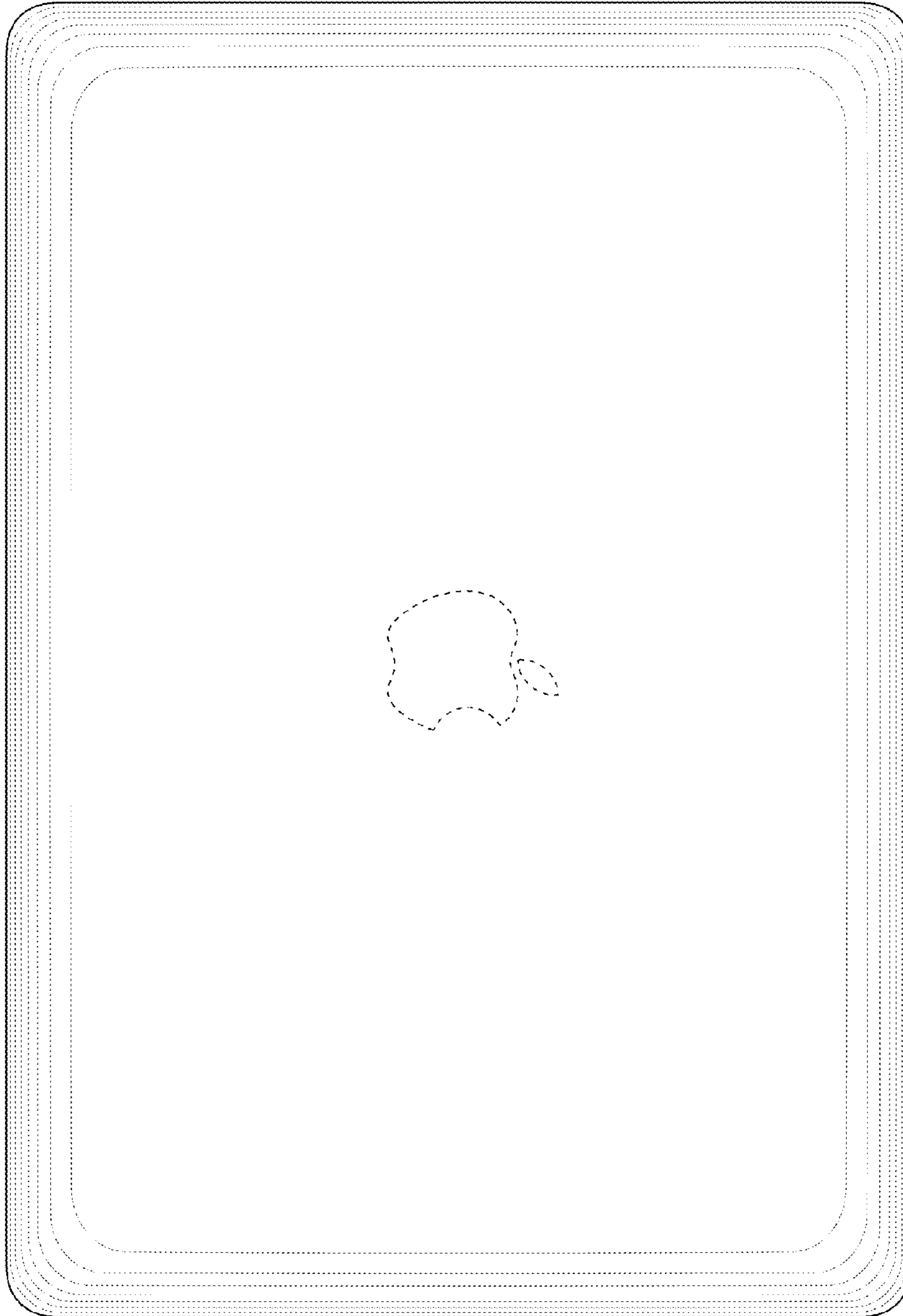

FIG. 3

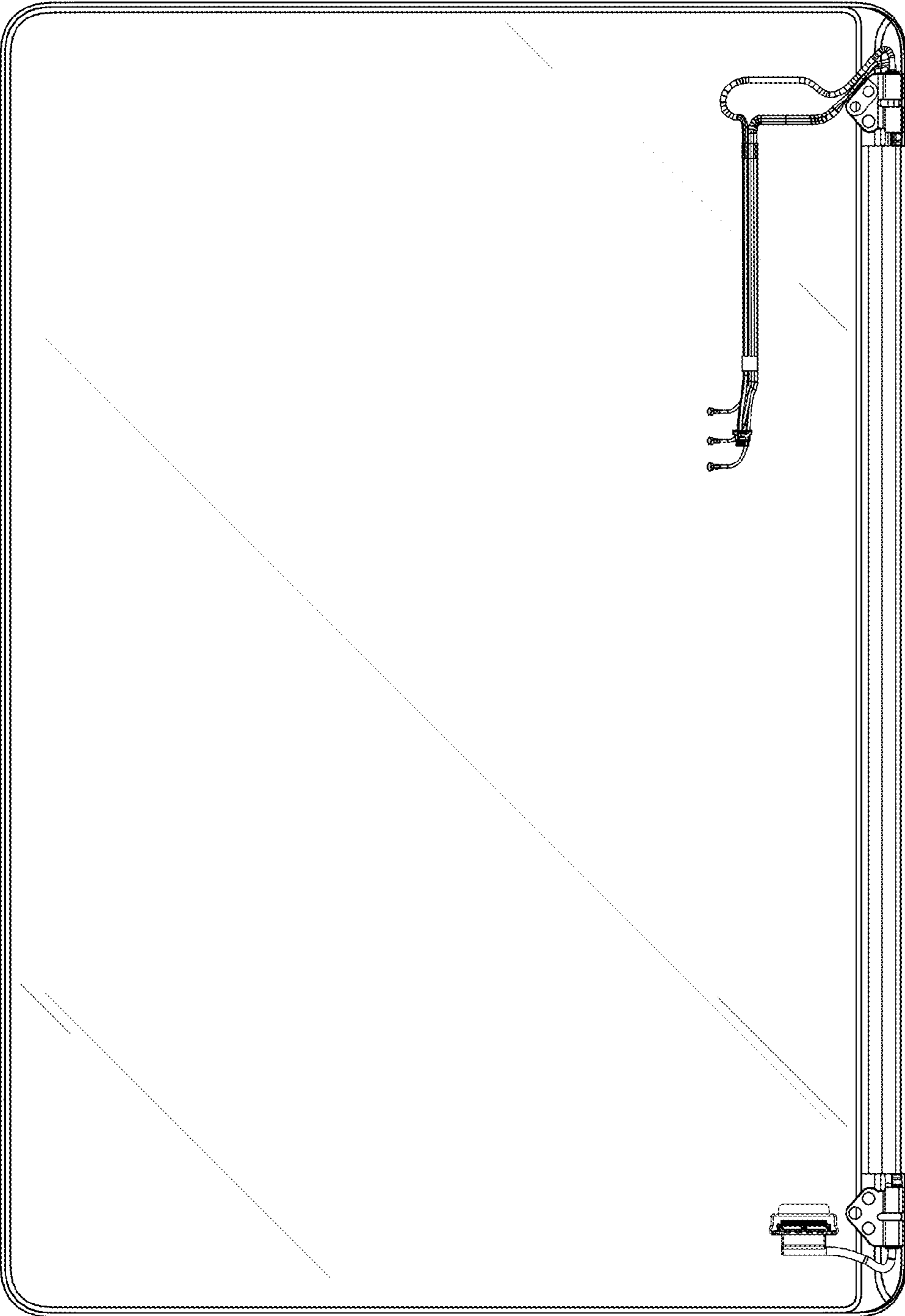

FIG. 4

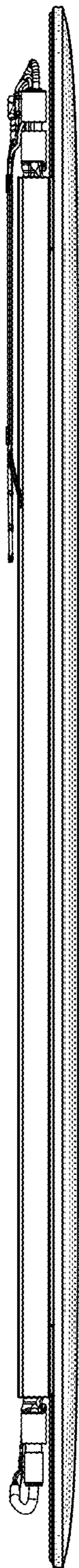

FIG. 5

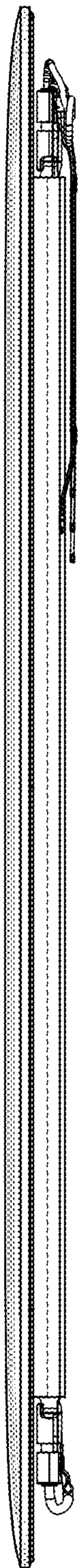

FIG. 6

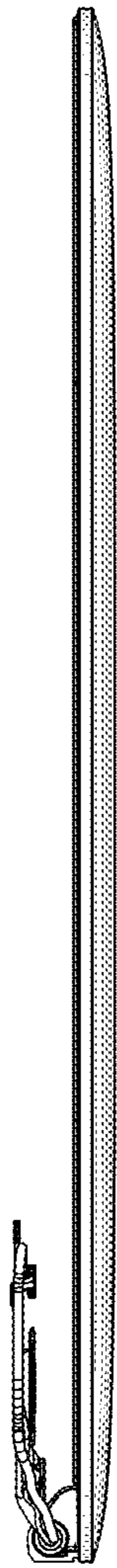

FIG. 7

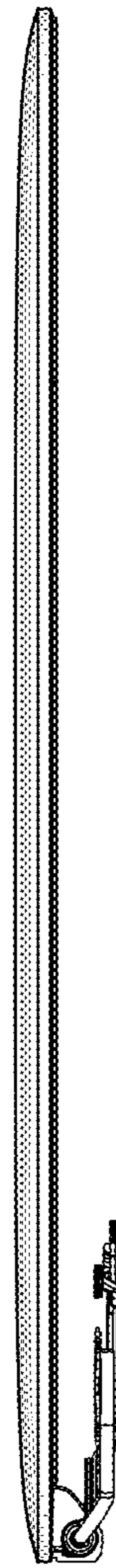

FIG. 8



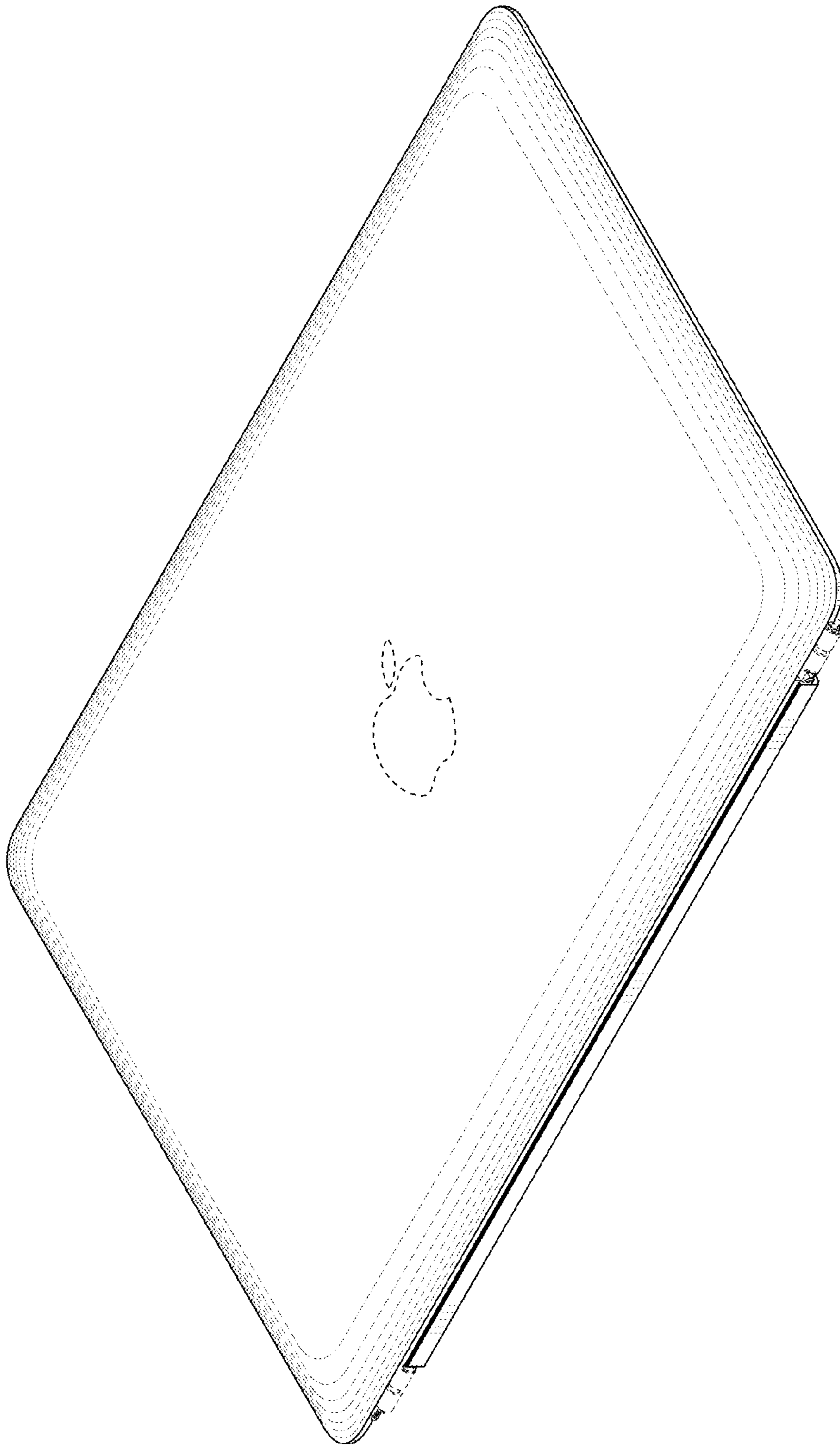

FIG. 9

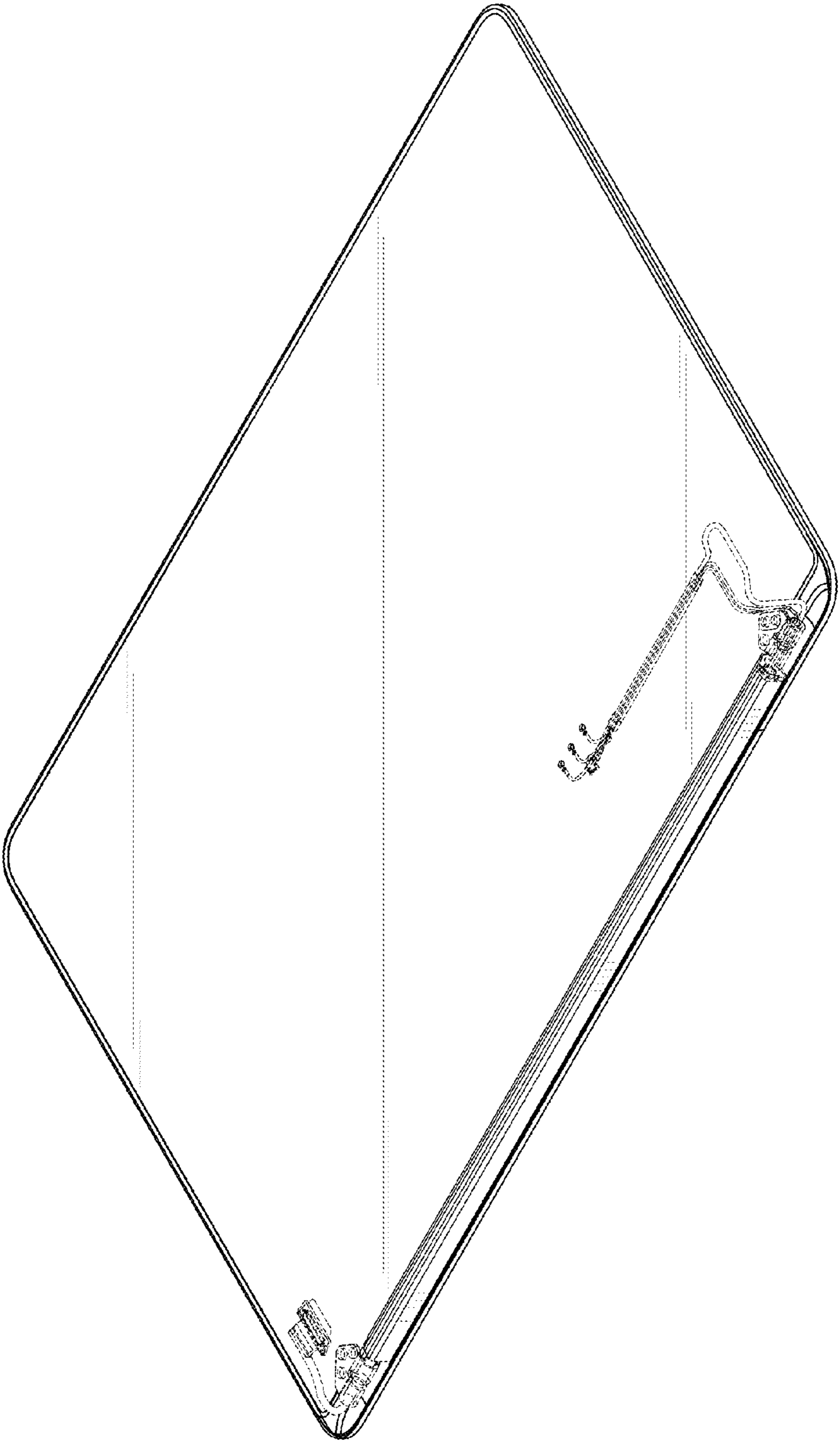

FIG. 10

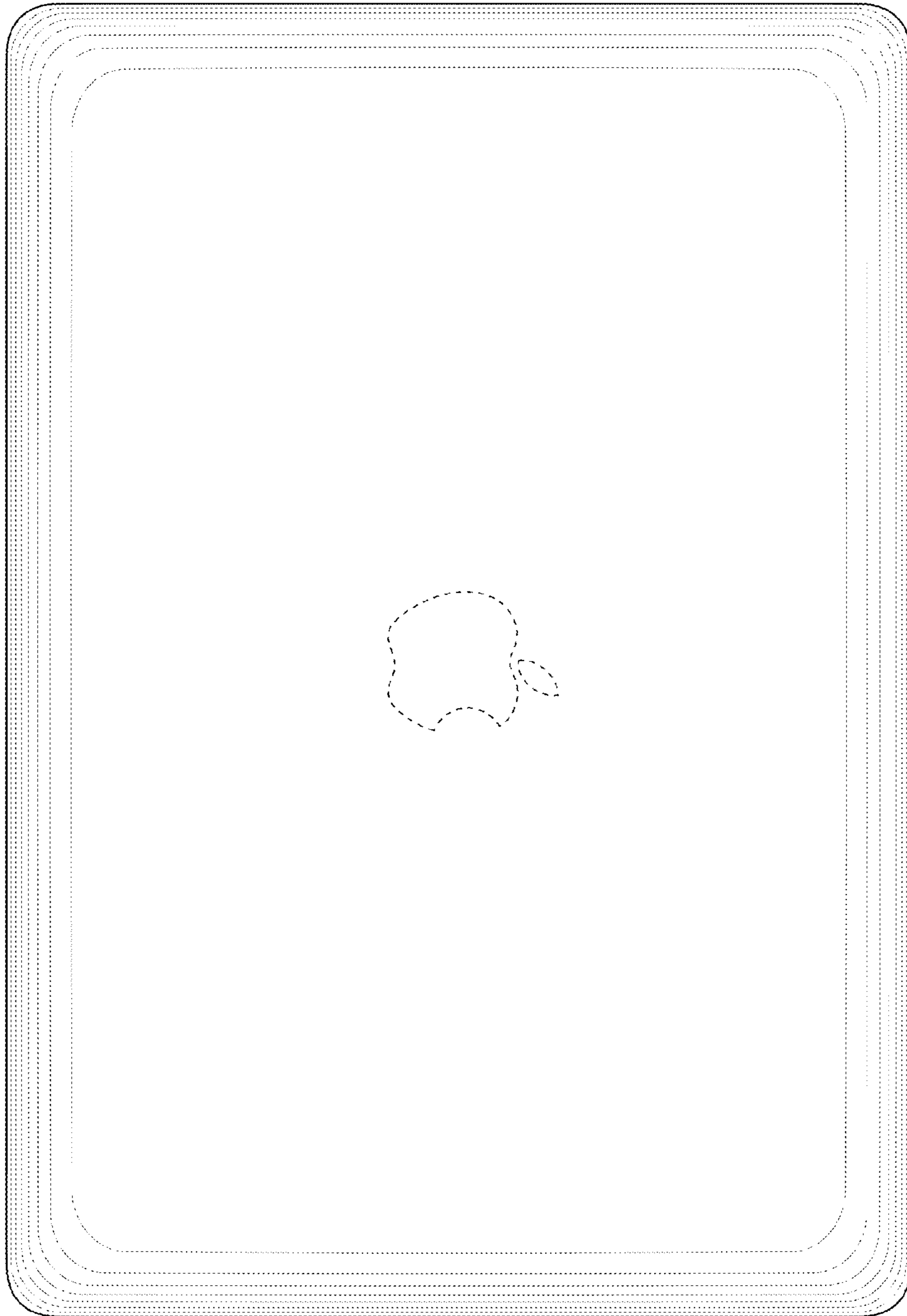

FIG. 11

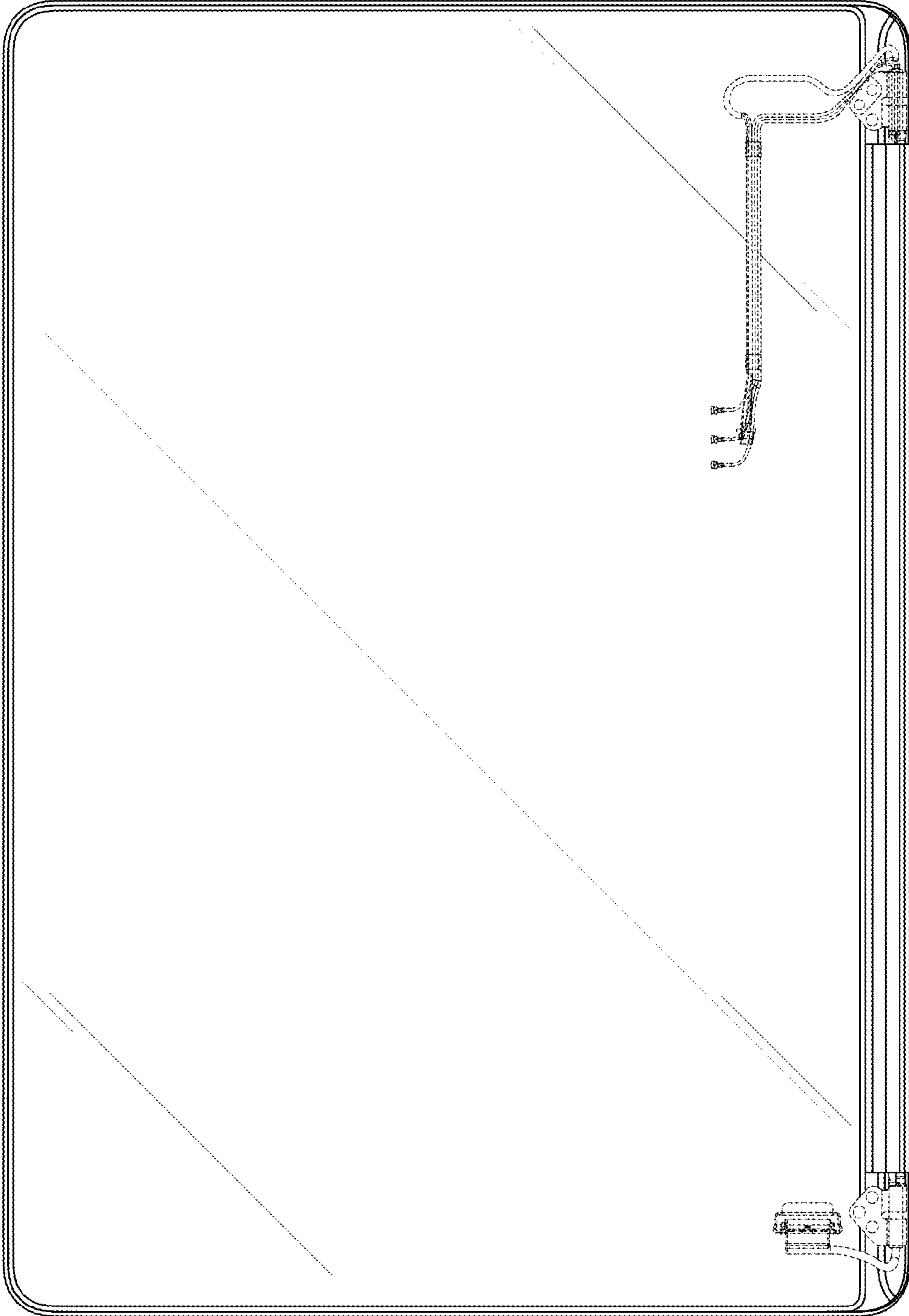

FIG. 12

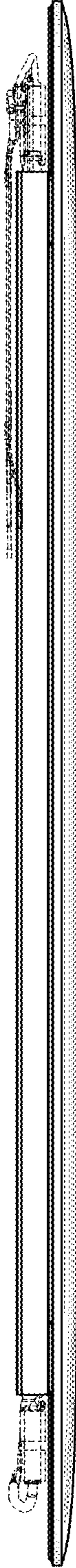

FIG. 13

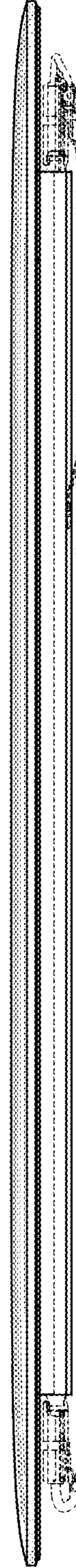

FIG. 14

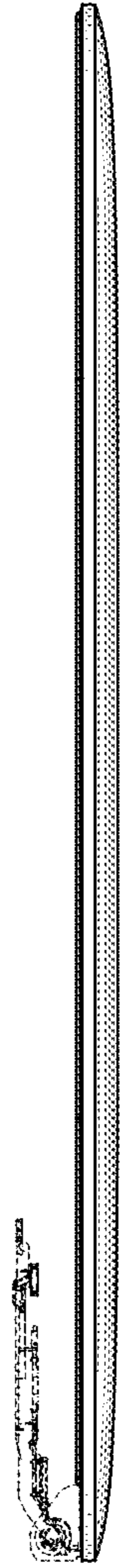

FIG. 15

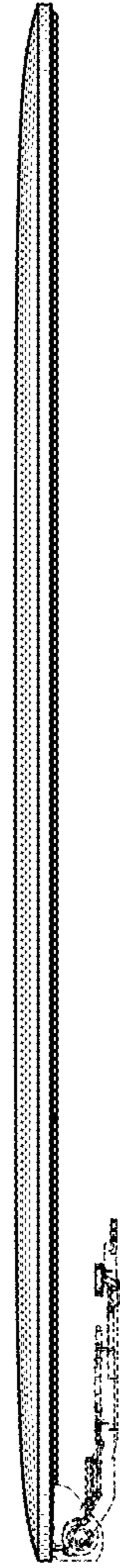

FIG. 16