



US00D709719S

(12) **United States Design Patent**  
**Hsu**

(10) **Patent No.:** **US D709,719 S**  
(45) **Date of Patent:** **\*\* Jul. 29, 2014**

(54) **ORGANIZER**

(71) Applicant: **Seville Classics, Inc.**, Torrance, CA (US)

(72) Inventor: **Li-Han Hsu**, Torrance, CA (US)

(73) Assignee: **Seville Classics Inc**, Torrance, CA (US)

(\*\*) Term: **14 Years**

(21) Appl. No.: **29/470,477**

(22) Filed: **Oct. 22, 2013**

(51) **LOC (10) Cl.** ..... **06-06**

(52) **U.S. Cl.**

USPC ..... **D6/683.1**

(58) **Field of Classification Search**

USPC ..... D6/408, 509–511, 462–465, 566–567,  
D6/569–572, 574, 672, 675, 675.5, 682,  
D6/682.2, 682.4, 683–683.1;  
211/59.2–59.3, 90.03, 85.31, 85.26,  
211/126.5, 126.9, 134, 153, 186–188,  
211/181.1; 312/42, 45, 72; 108/59–60, 152,  
108/191, 108, 147.11; 248/312, 235, 243,  
248/219.1, 250

See application file for complete search history.

(56) **References Cited**

**U.S. PATENT DOCUMENTS**

3,083,836 A \* 4/1963 Bussemer ..... 211/134  
D273,643 S \* 5/1984 Sanker et al. .... D6/503  
D277,723 S \* 2/1985 Wolff ..... D6/475  
D438,724 S \* 3/2001 Trulaske, Sr. .... D6/408

D470,451 S \* 2/2003 Bushart et al. .... D12/412  
D473,359 S \* 4/2003 Joseph ..... D32/55  
D538,106 S \* 3/2007 Julian ..... D7/409  
D542,092 S \* 5/2007 Raichlen et al. .... D7/409  
D544,250 S \* 6/2007 Daugherty et al. .... D6/463  
D544,251 S \* 6/2007 Daugherty et al. .... D6/463  
D560,937 S \* 2/2008 Hwang ..... D6/510  
D579,691 S \* 11/2008 Snider ..... D6/463  
D586,583 S \* 2/2009 Schluter et al. .... D6/462  
D628,856 S \* 12/2010 Wang et al. .... D7/601  
D668,103 S \* 10/2012 Cloutier et al. .... D7/402  
D680,361 S \* 4/2013 Zobel et al. .... D6/705  
D687,253 S \* 8/2013 McIntyre ..... D6/705.6  
D699,073 S \* 2/2014 Cheung ..... D7/402  
D699,986 S \* 2/2014 Tsai ..... D6/675.4

\* cited by examiner

*Primary Examiner* — Kelley Donnelly

(74) *Attorney, Agent, or Firm* — Raymond Sun

(57) **CLAIM**

The ornamental design for an organizer, as shown and described.

**DESCRIPTION**

FIG. 1 is a perspective view of an organizer showing the new design;

FIG. 2 is a front plan view thereof;

FIG. 3 is a right plan view thereof;

FIG. 4 is a left plan view thereof;

FIG. 5 is a top plan view thereof;

FIG. 6 is a bottom plan view thereof; and,

FIG. 7 is a rear plan view.

**1 Claim, 7 Drawing Sheets**

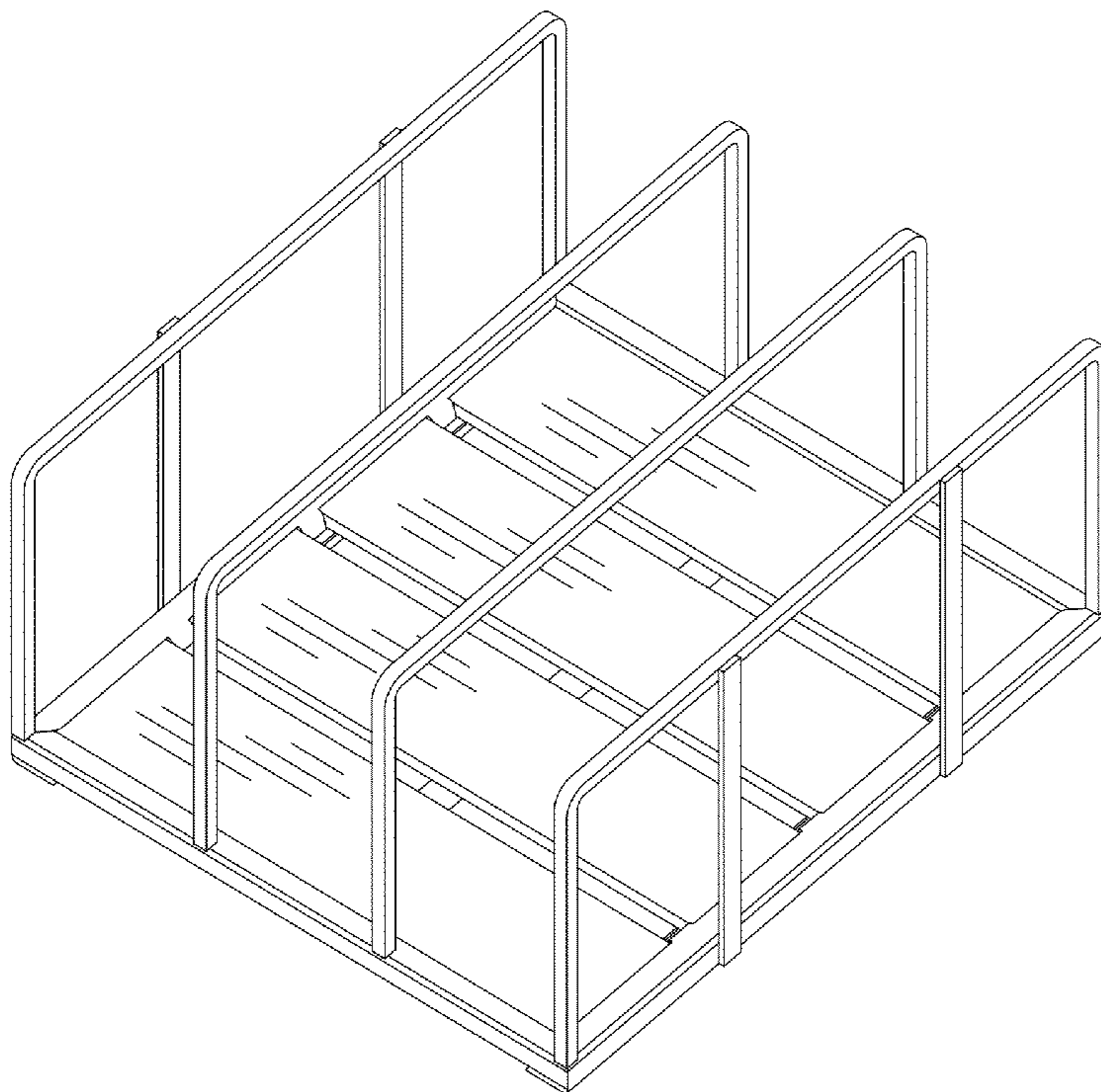

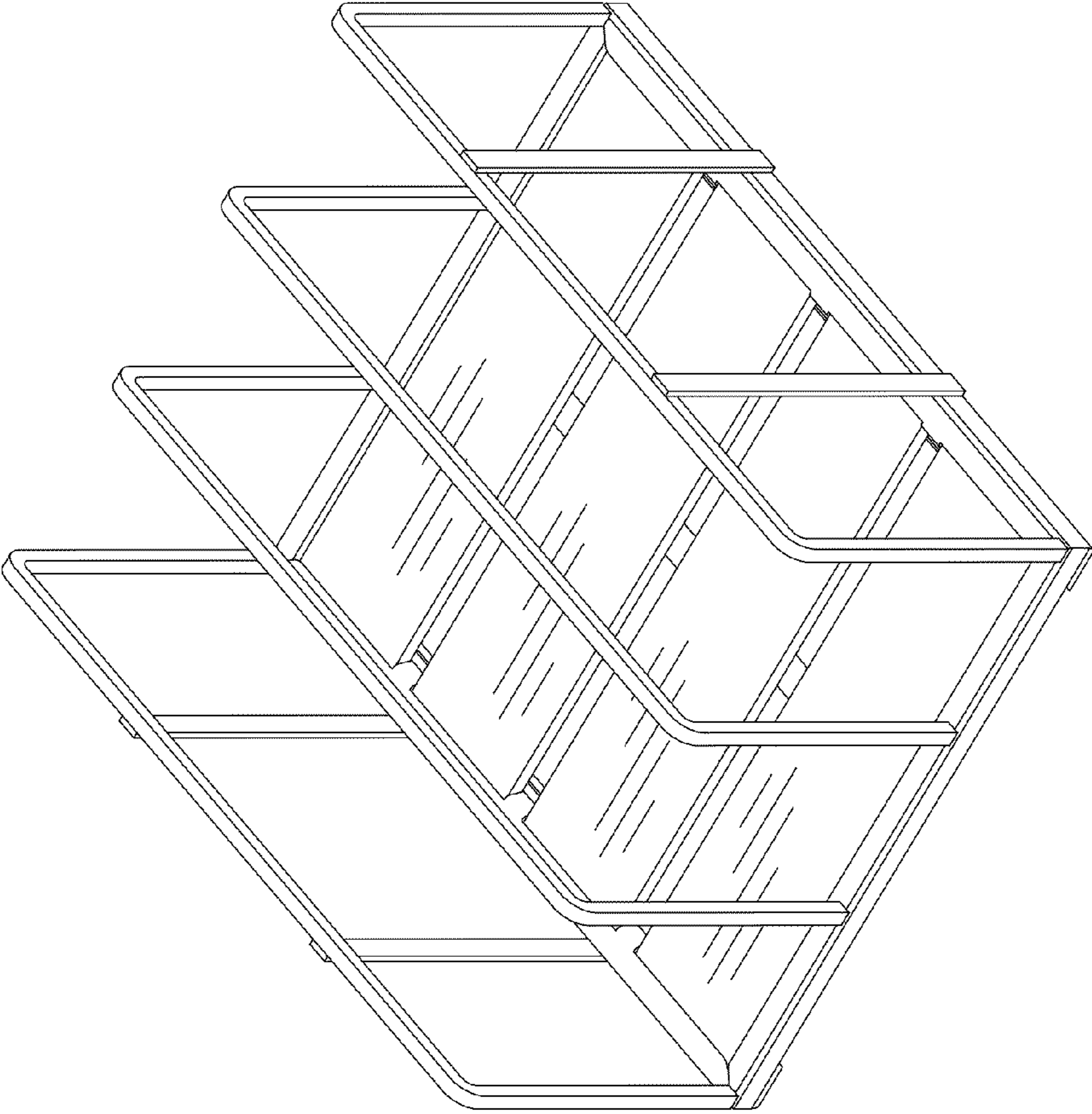

FIG. 1

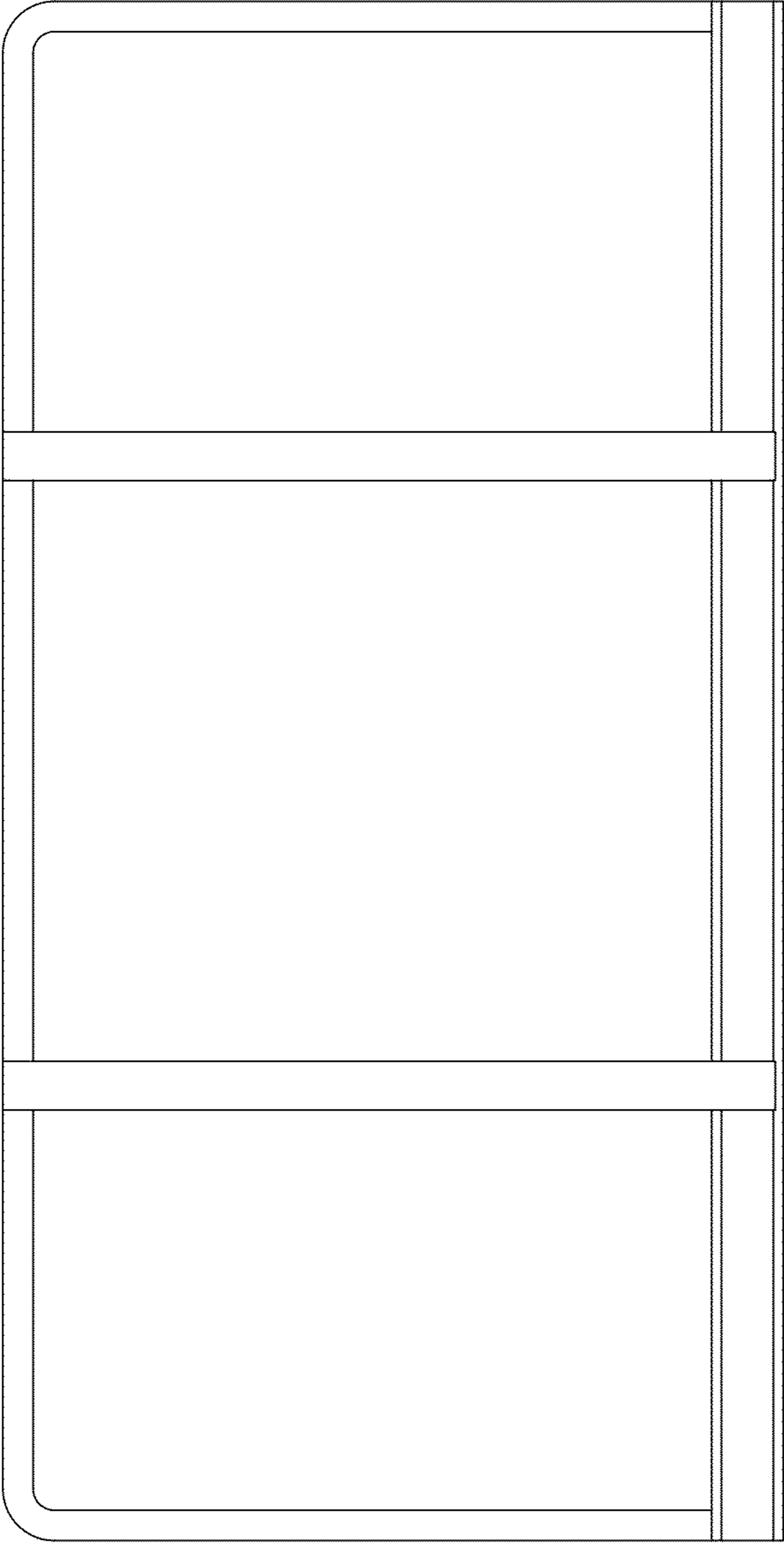

FIG. 2

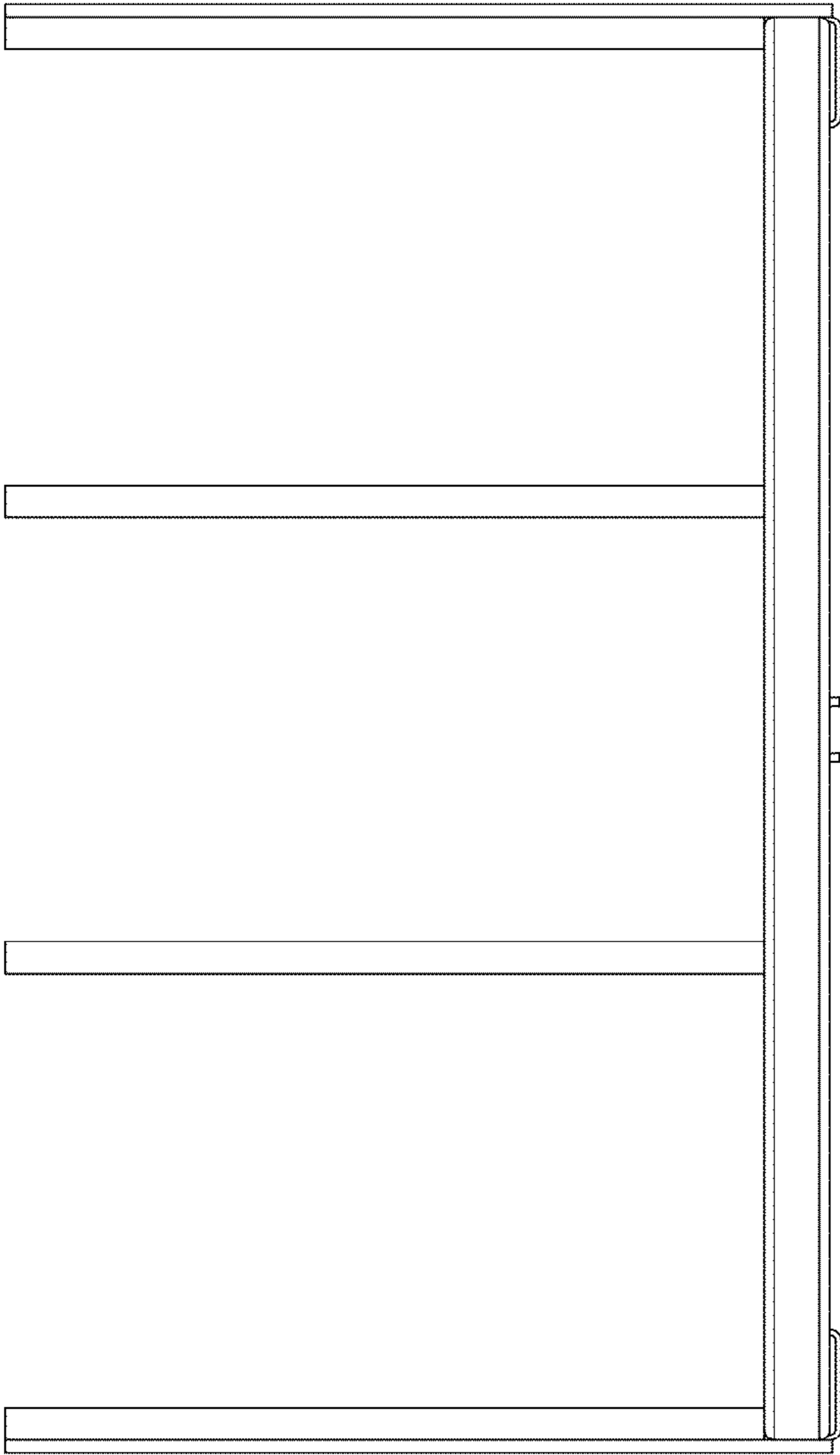

FIG. 3

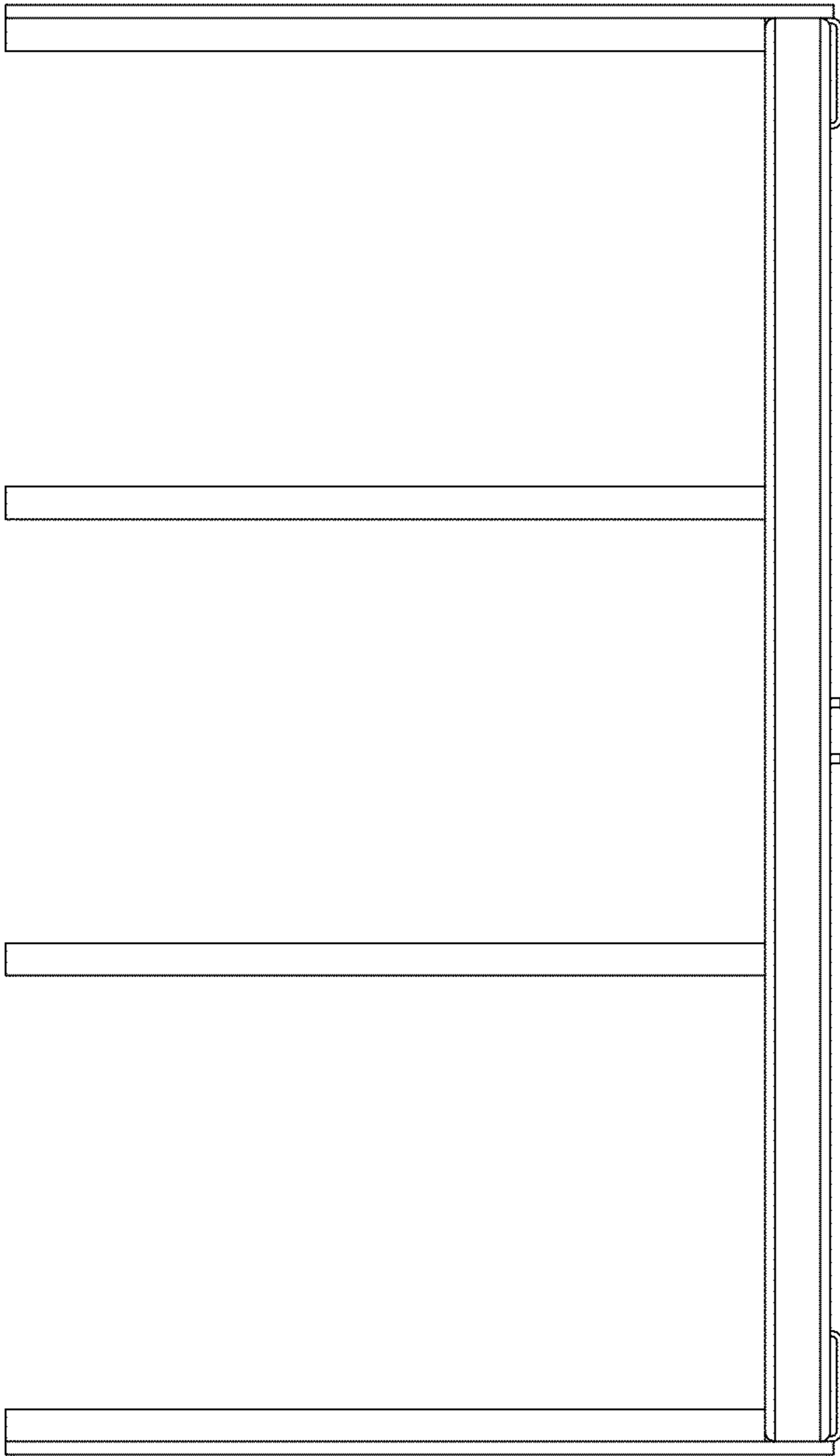

FIG. 4

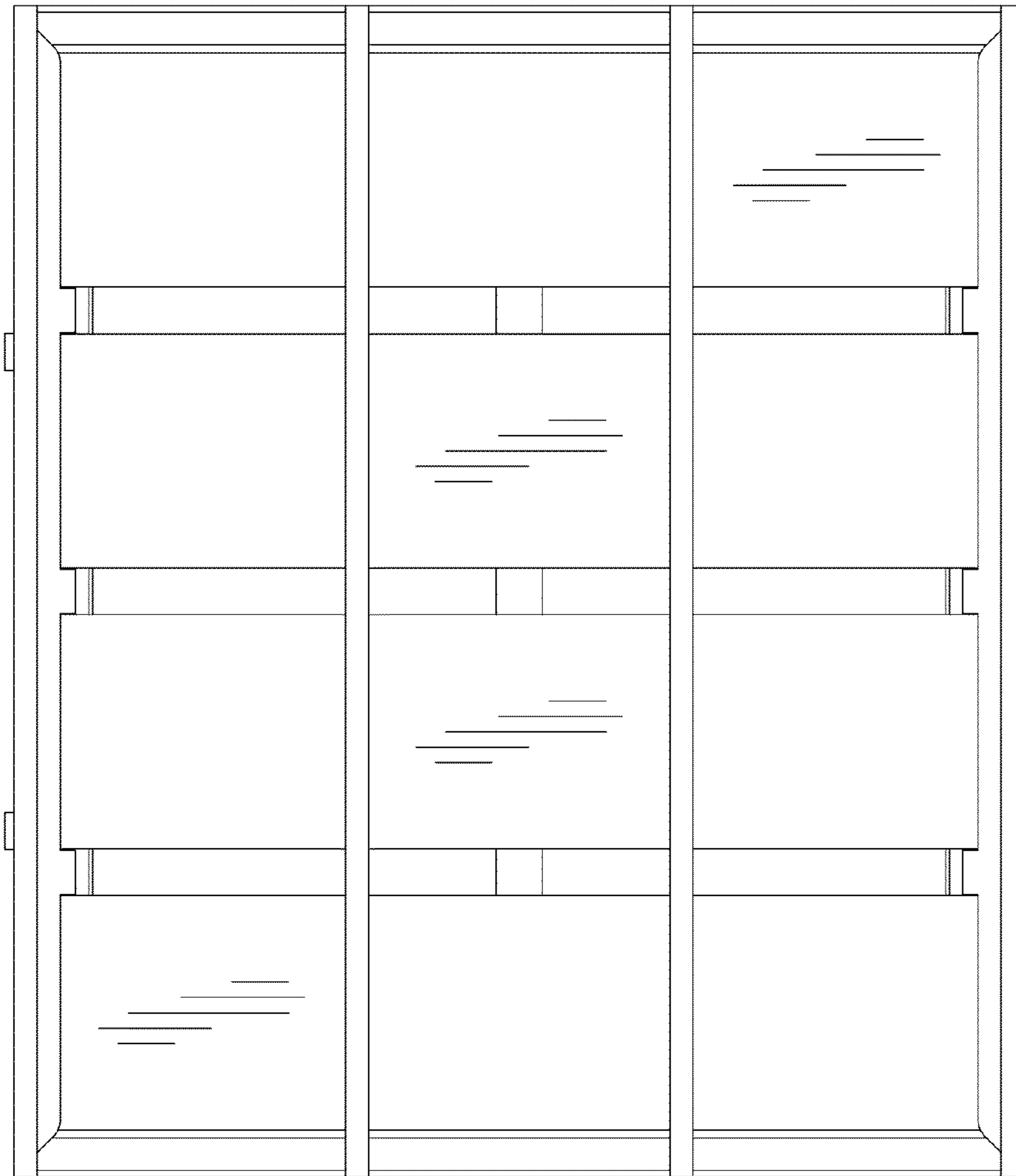

FIG. 5

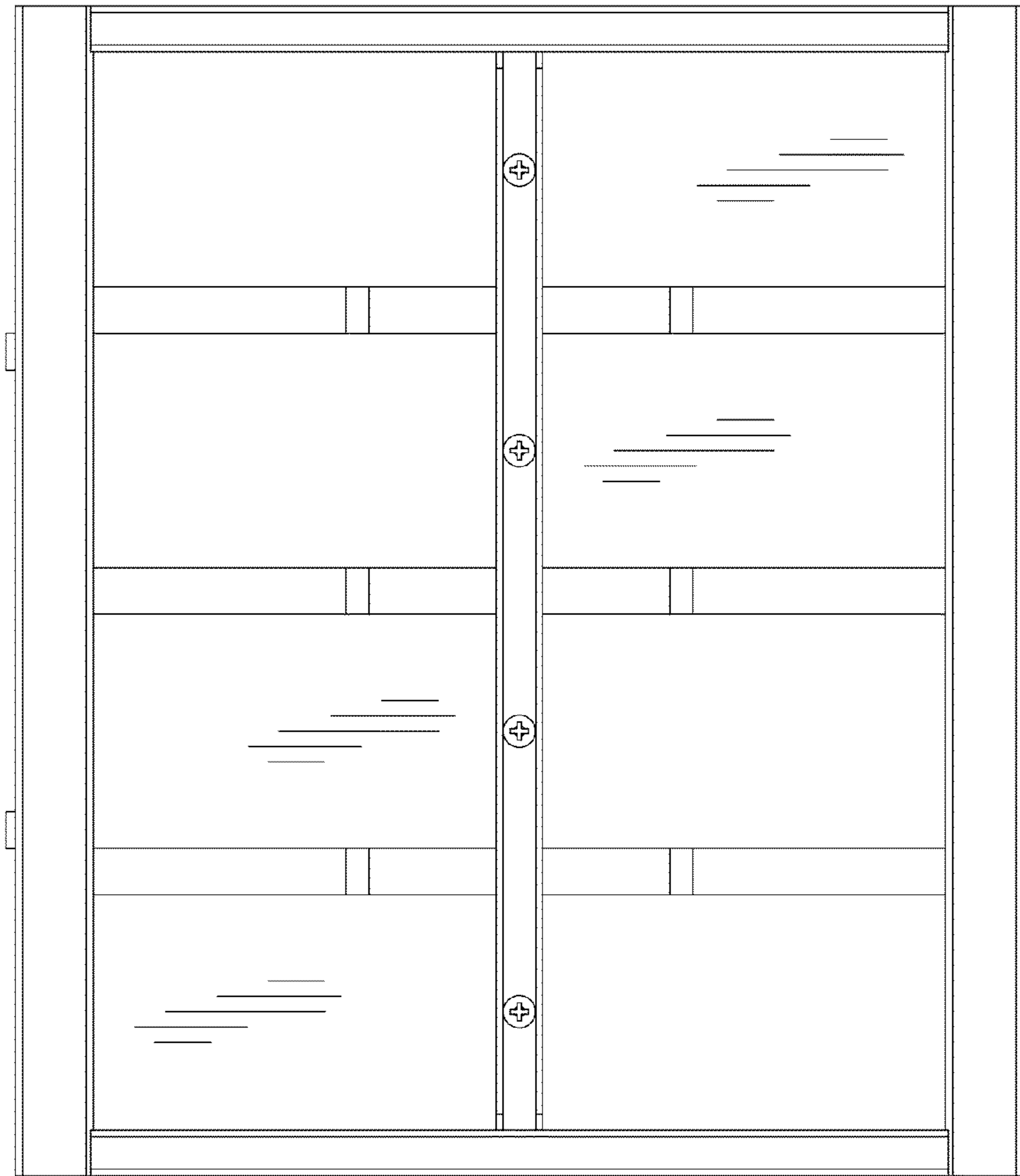

FIG. 6

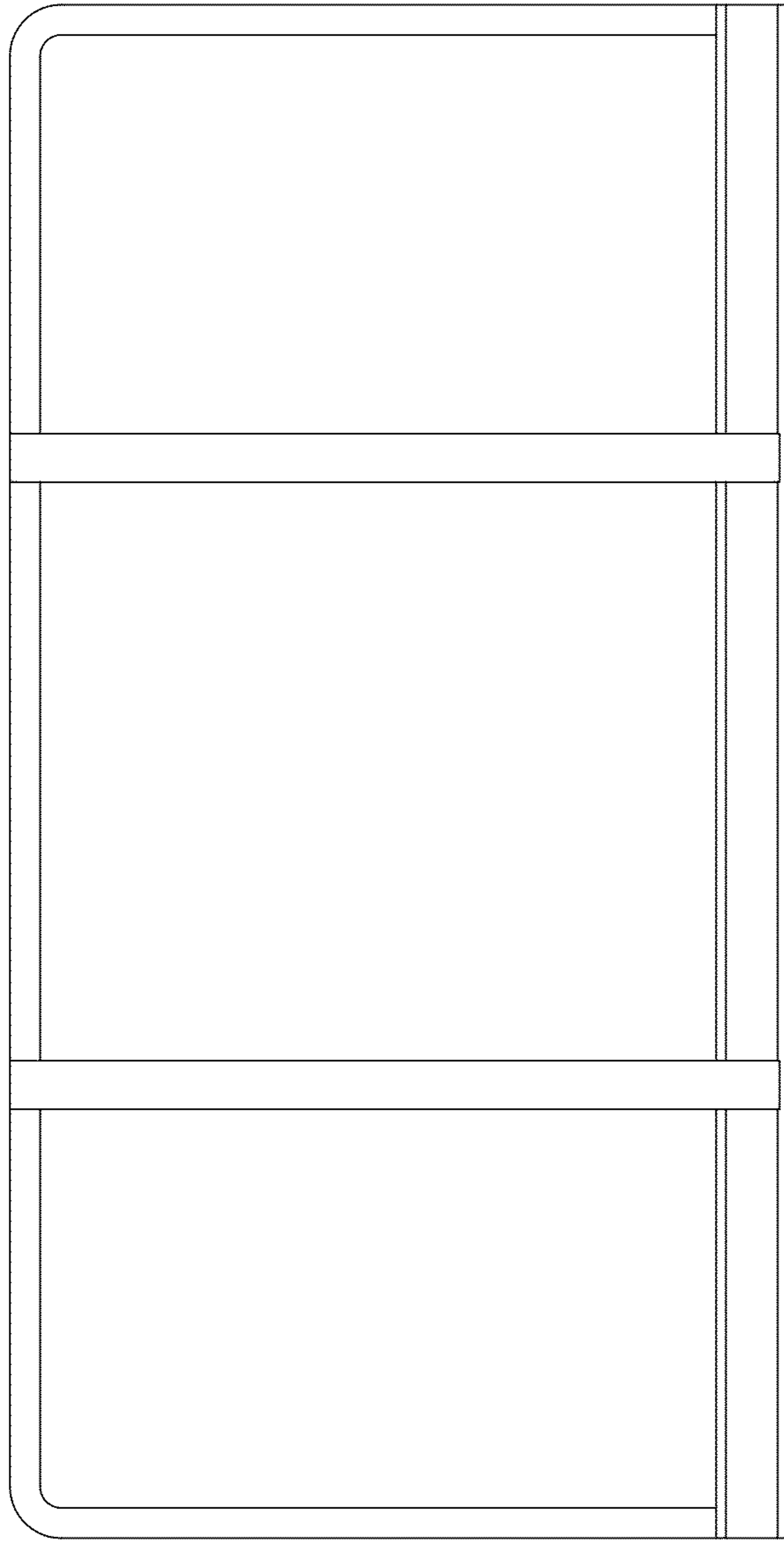

FIG. 7