



US00D709685S

(12) **United States Design Patent**
Spring

(10) **Patent No.:** **US D709,685 S**

(45) **Date of Patent:** **** Jul. 29, 2014**

(54) **FOOTWEAR**

(75) **Inventor:** **Angie Spring**, Portland, OR (US)

(73) **Assignee:** **Sorel Corporation**, Portland, OR (US)

(**) **Term:** **14 Years**

(21) **Appl. No.:** **29/420,617**

(22) **Filed:** **May 10, 2012**

(51) **LOC (10) Cl.** **02-99**

(52) **U.S. Cl.**
USPC **D2/971**; D2/929; D2/936; D2/940

(58) **Field of Classification Search**
USPC D2/896, 916, 925-942, 946, 969, 971;
36/1, 7.5-7.8, 83, 8.3, 45-58, 104,
36/108, 76 R, 58.5, 58.6
See application file for complete search history.

(56) **References Cited**

U.S. PATENT DOCUMENTS

D64,104 S *	2/1924	Kezy	D2/911
D100,136 S *	6/1936	Troy	D2/912
D105,061 S *	6/1937	Jodencrants	D2/939
D105,412 S *	7/1937	Saccal	D2/935
D106,547 S *	10/1937	Sutton	D2/942
D116,700 S *	9/1939	Calderazzo	D2/932
D118,928 S *	2/1940	Elkin	D2/930

D127,117 S *	5/1941	Wood	D2/928
D127,118 S *	5/1941	Wood	D2/928
D127,119 S *	5/1941	Wood	D2/928
D127,531 S *	5/1941	Wolock	D2/940
D514,301 S *	2/2006	Kelsey	D2/971
D605,394 S *	12/2009	Guers-Neyraud	D2/971
D632,884 S *	2/2011	Issler	D2/971

* cited by examiner

Primary Examiner — Dominic Simone

(74) *Attorney, Agent, or Firm* — Schwabe, Williamson & Wyatt, P.C.

(57) **CLAIM**

I claim the ornamental design for footwear, as shown and described.

DESCRIPTION

FIG. 1 is a perspective view of footwear, showing my new design;
FIG. 2 is a left side view thereof;
FIG. 3 is a right side view thereof;
FIG. 4 is a top view thereof;
FIG. 5 is a bottom view thereof;
FIG. 6 is a front view thereof; and,
FIG. 7 is a back view thereof.

The dashed lines are included for illustrating environmental structure and form no part of the claimed design.

1 Claim, 6 Drawing Sheets

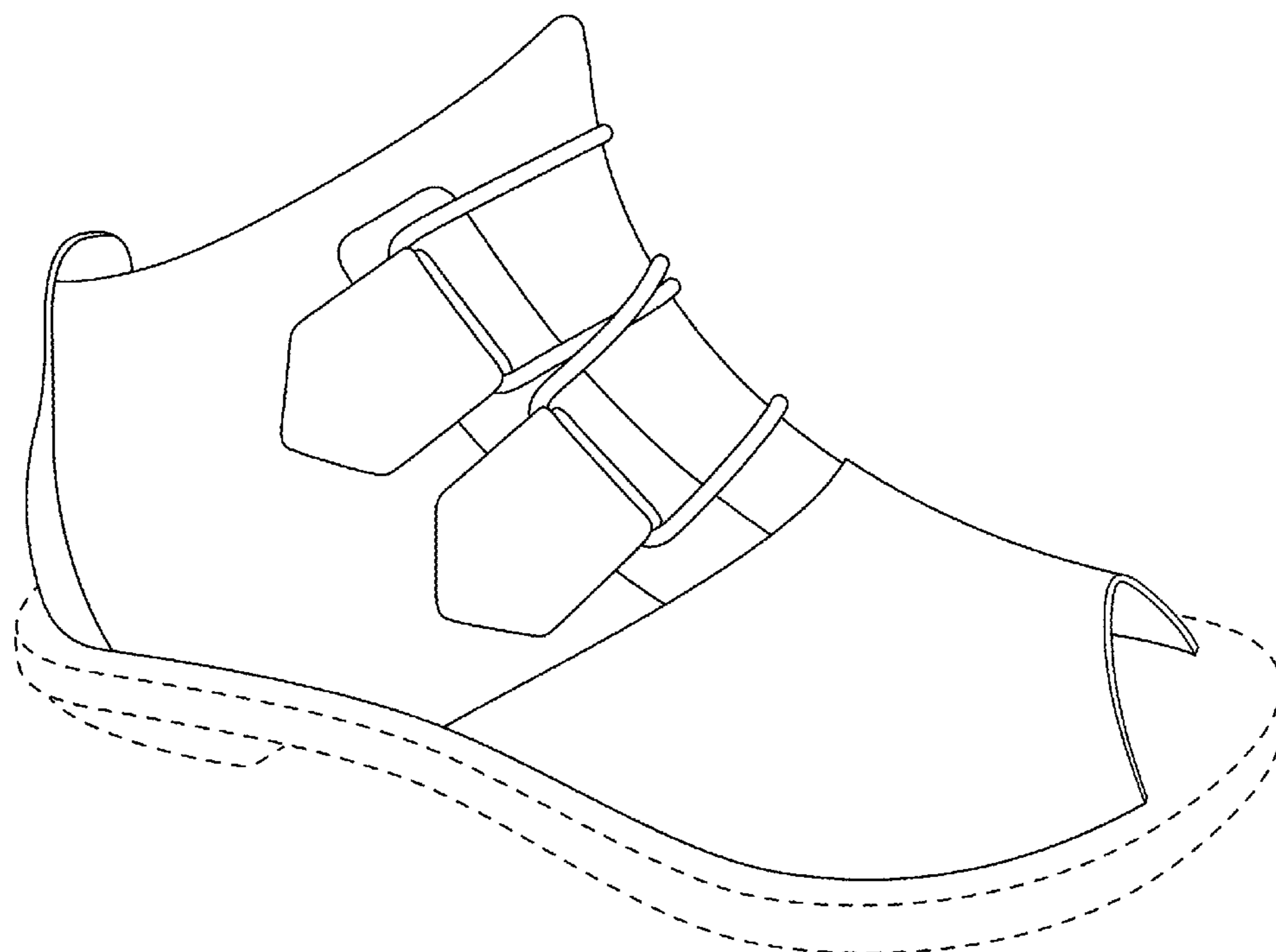

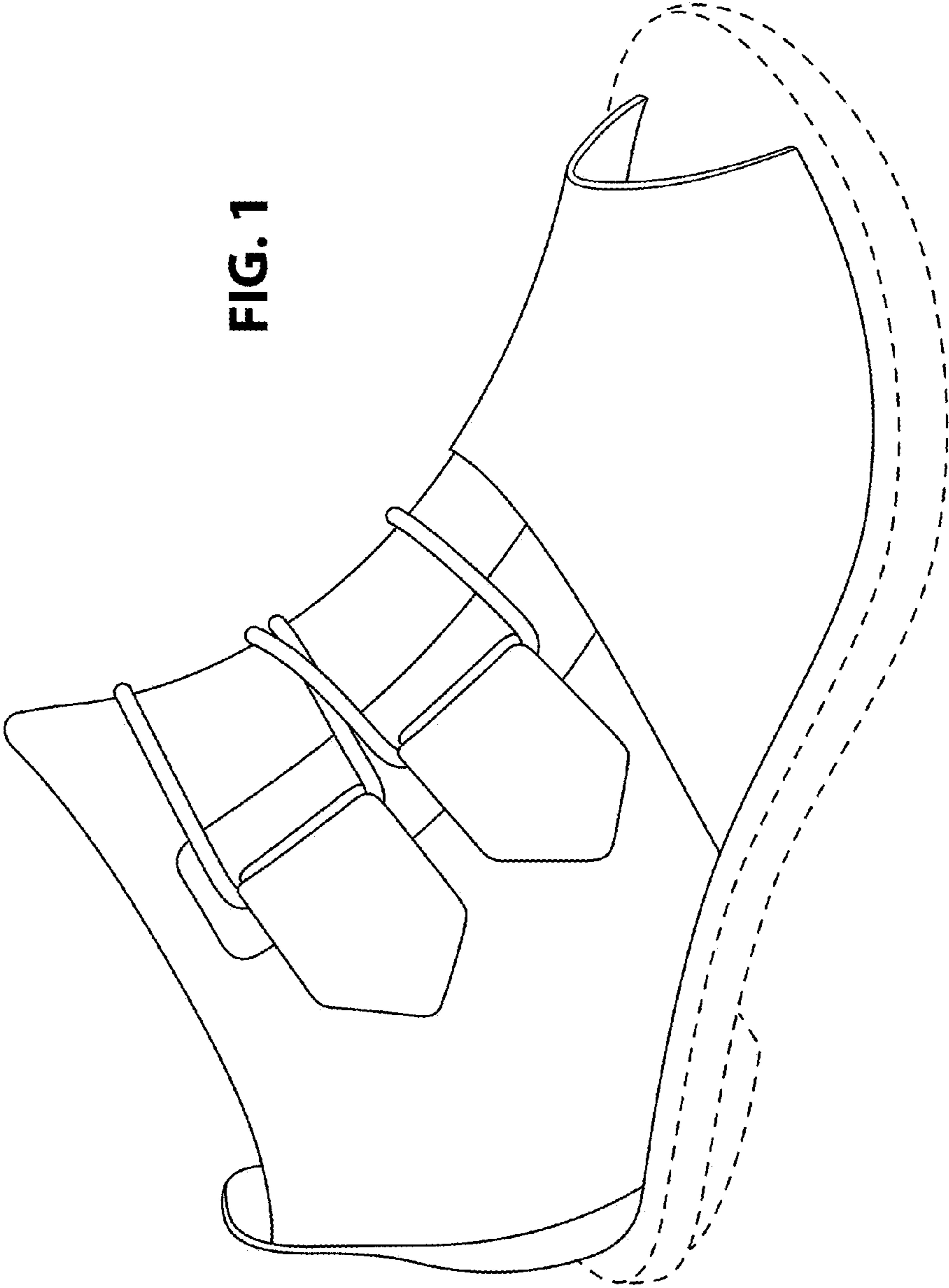
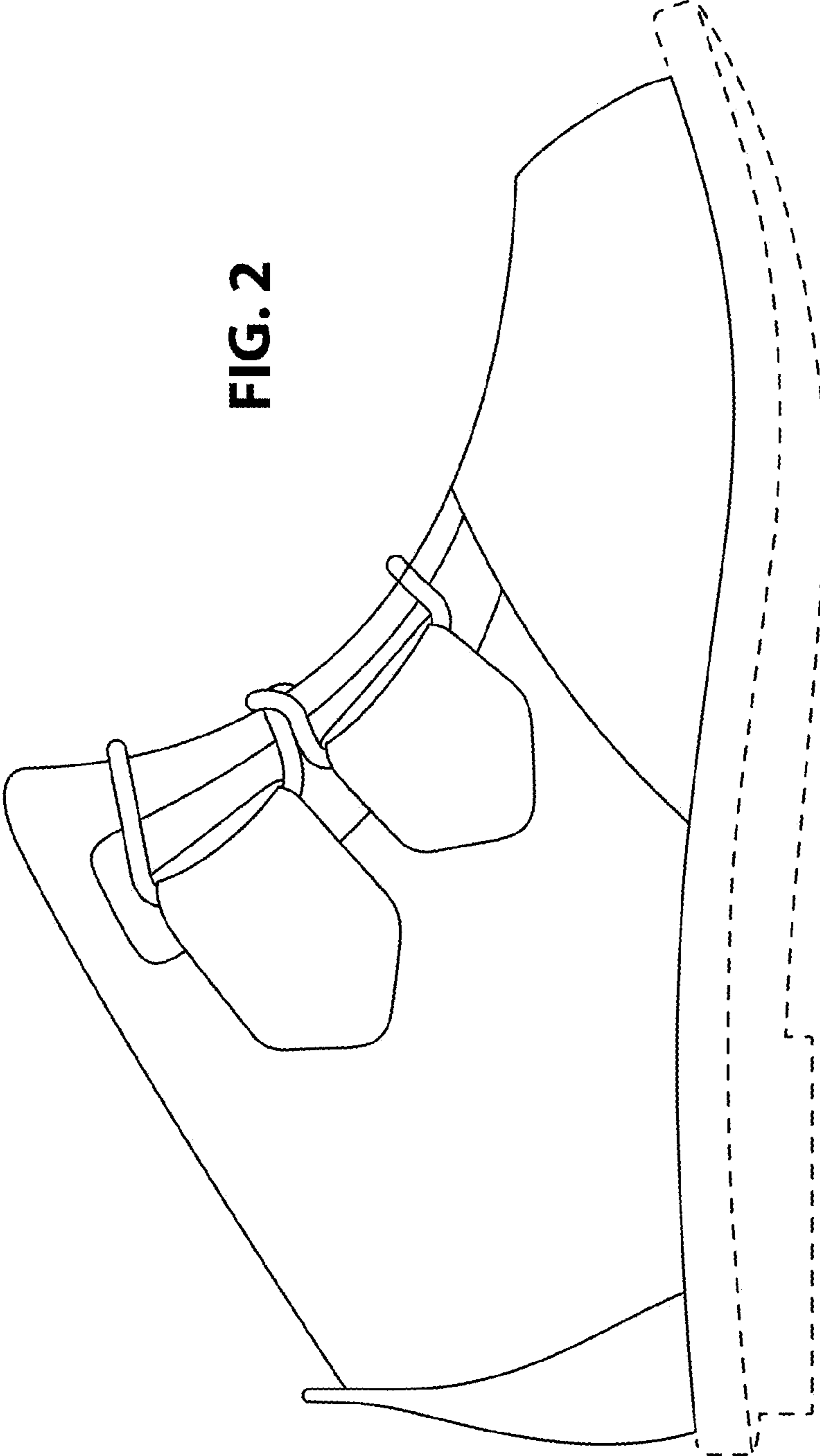

FIG. 1

FIG. 2



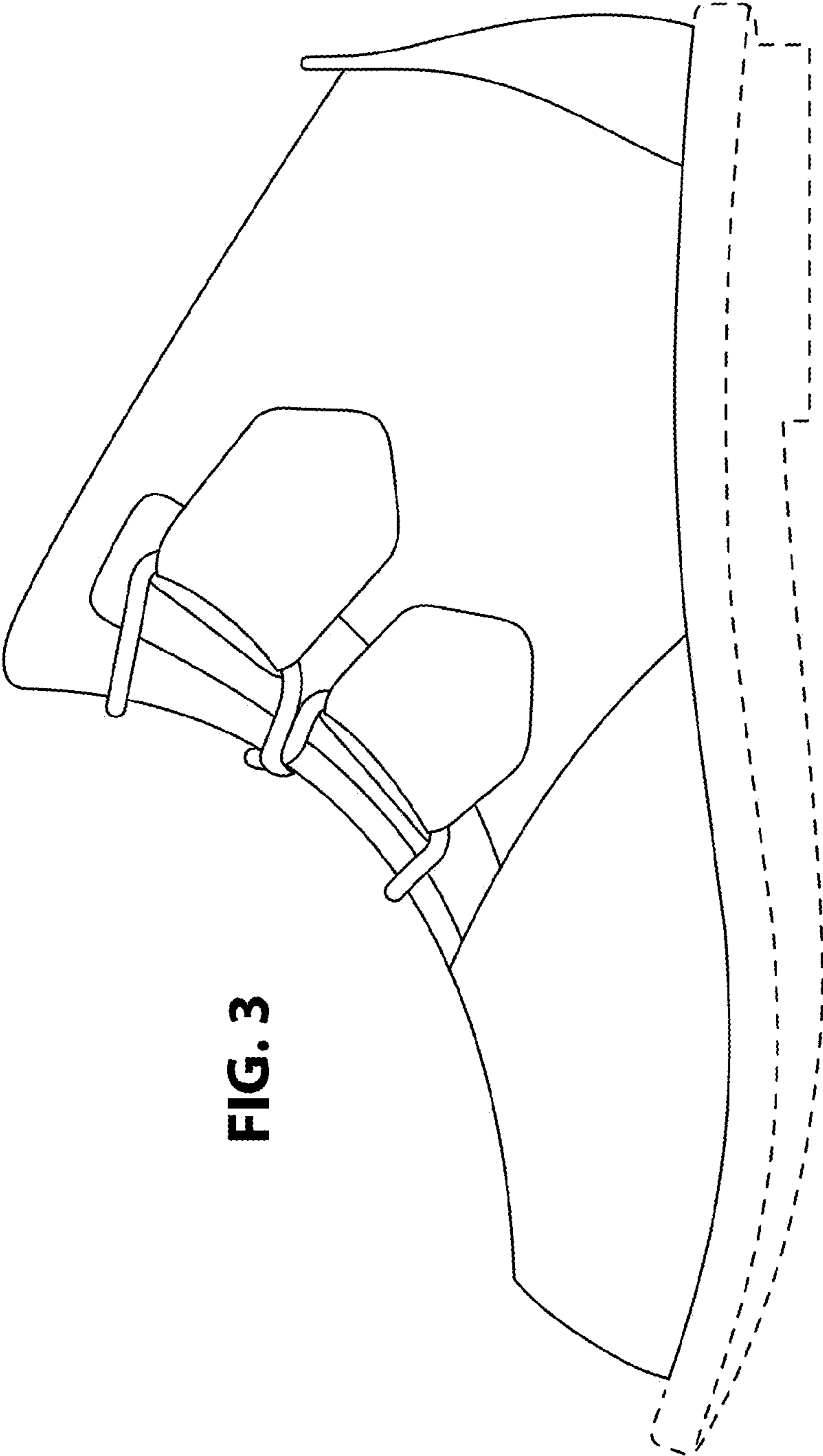

FIG. 3

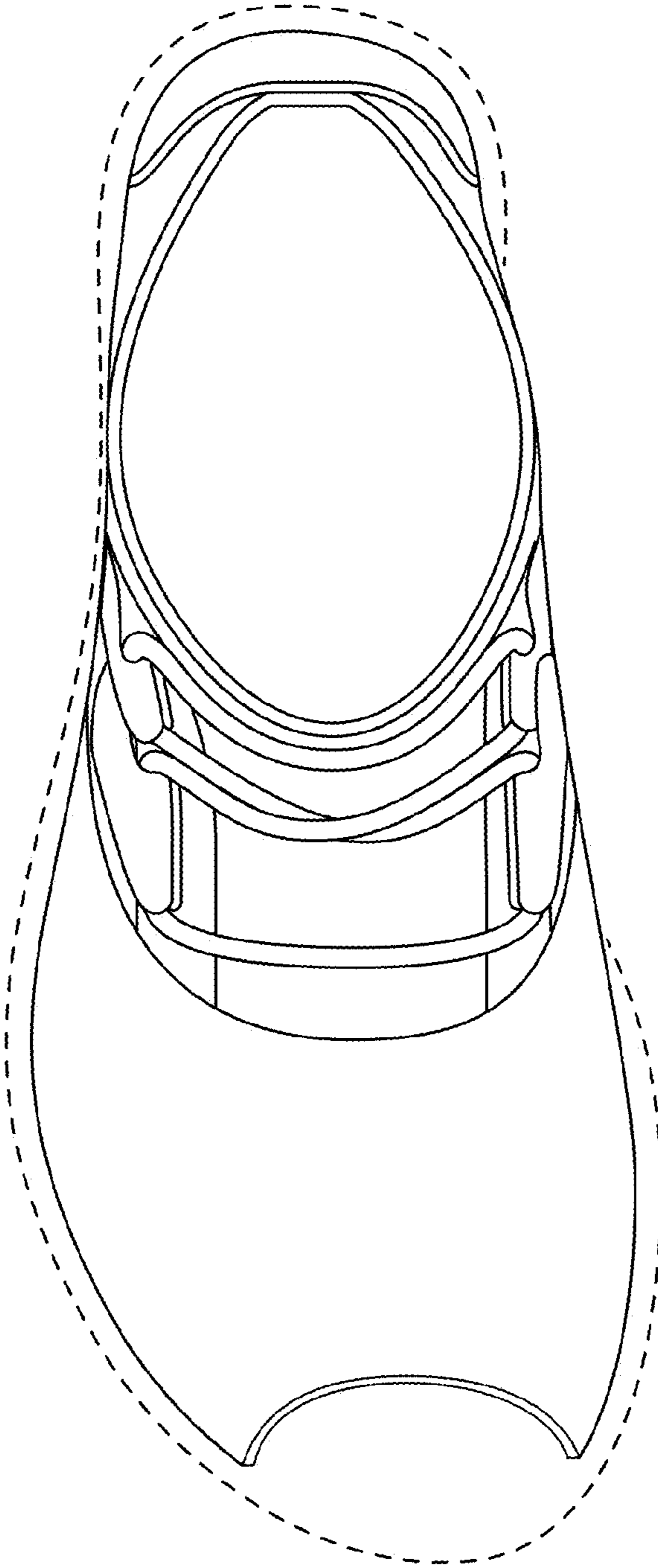

FIG. 4

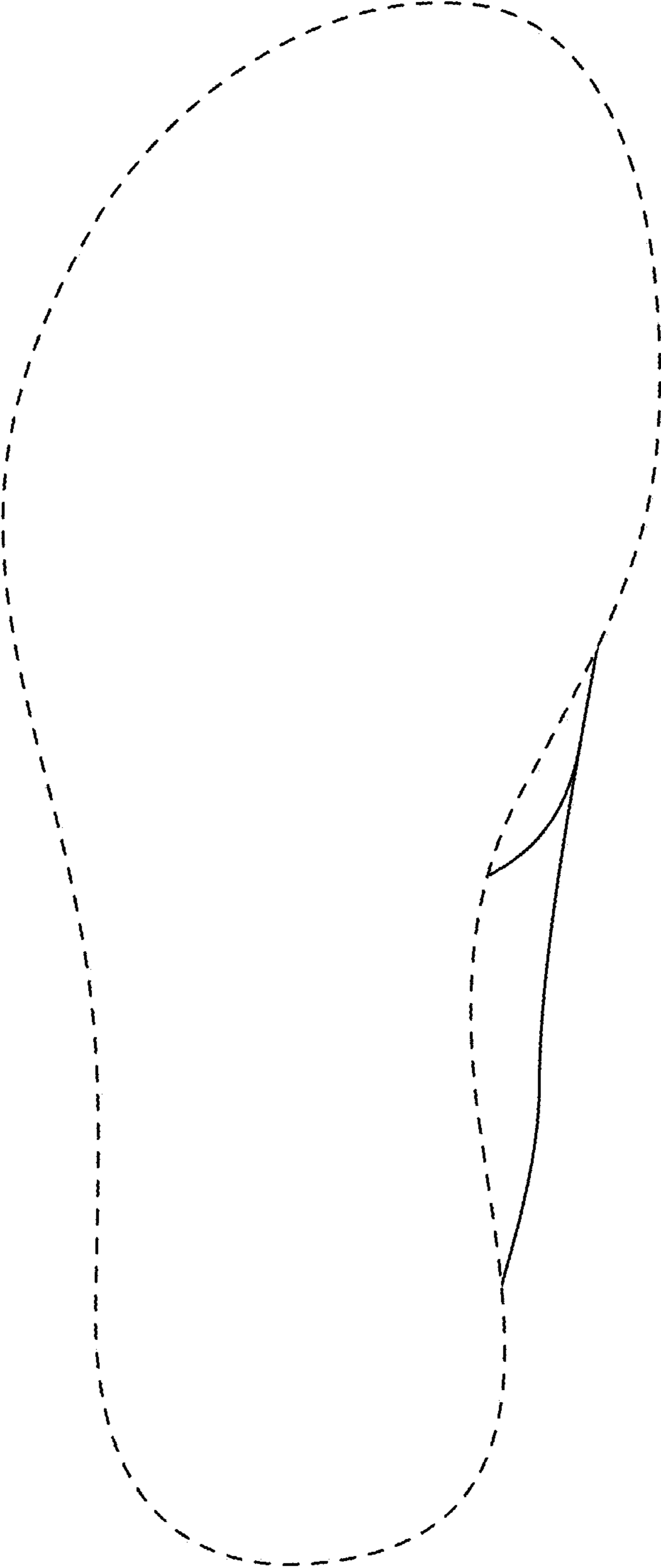

FIG. 5

FIG. 7

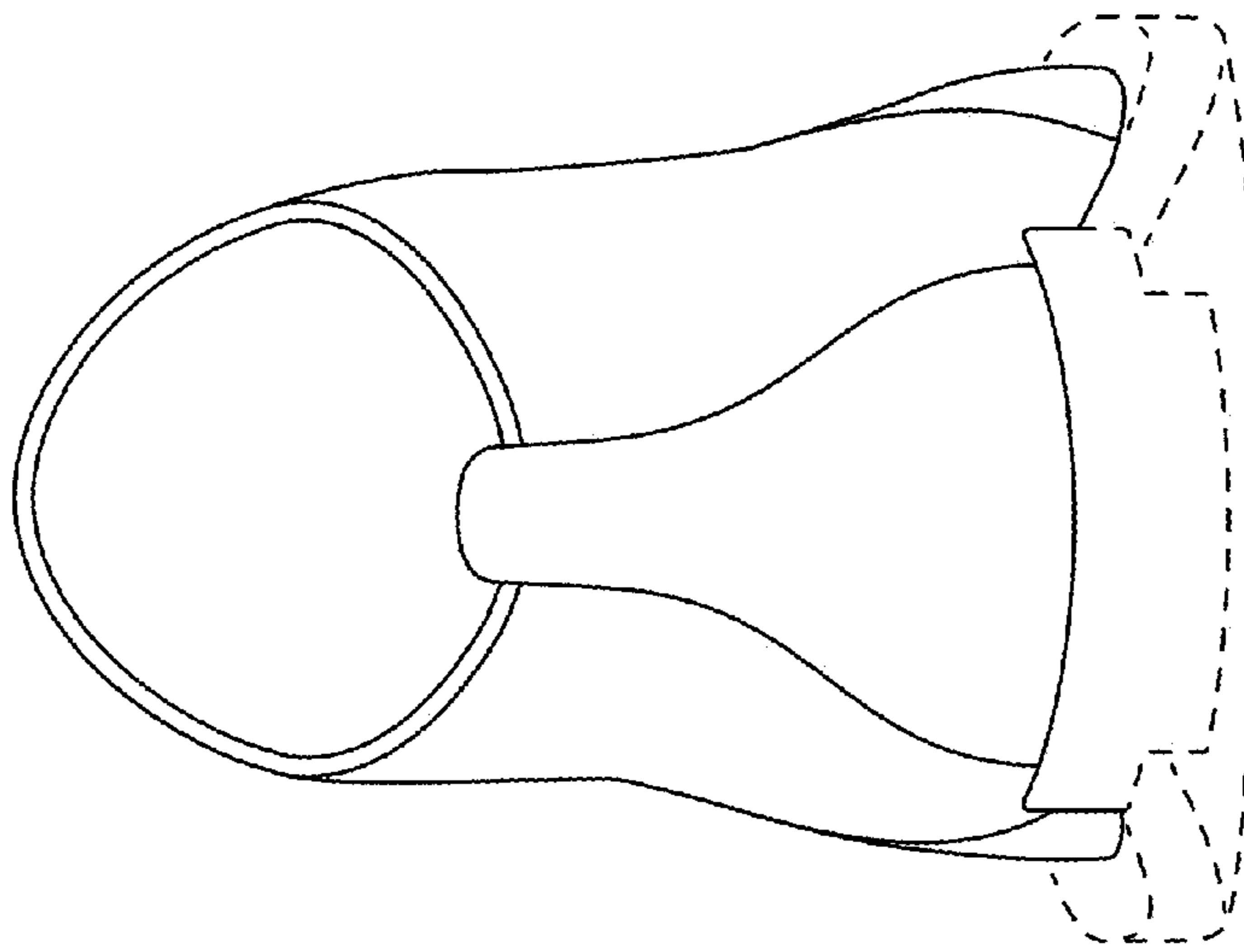

FIG. 6

