



US00D709670S

(12) **United States Design Patent**
Vericella

(10) **Patent No.:** **US D709,670 S**
(45) **Date of Patent:** **** Jul. 29, 2014**

(54) **BRA WITH INTERCHANGEABLE BACK STRAP**

(76) Inventor: **Gina Vericella**, Chicago, IL (US)

(**) Term: **14 Years**

(21) Appl. No.: **29/426,940**

(22) Filed: **Jul. 11, 2012**

(51) **LOC (10) Cl.** **02-01**

(52) **U.S. Cl.**
USPC **D2/708**

(58) **Field of Classification Search**

USPC D2/700, 701, 702, 703, 704, 705, 706,
D2/707, 708, 709, 710, 731, 737, 793, 829,
D2/841; 2/67, 69, 104, 109; 450/1, 2, 34,
450/39, 45, 47, 48, 49, 63, 79, 80, 82, 86
See application file for complete search history.

(56) **References Cited**

U.S. PATENT DOCUMENTS

2,021,906	A *	11/1935	Whitaker	450/92
6,086,451	A	7/2000	Fernandes		
6,186,861	B1	2/2001	Flaherty		
6,200,194	B1	3/2001	Grier		
6,206,752	B1 *	3/2001	Fagin et al.	450/1
6,375,538	B1 *	4/2002	Allen et al.	450/41
6,517,409	B2	2/2003	Flaherty		
D475,835	S	6/2003	Hoffman		
D519,261	S	4/2006	Reis		
D535,807	S *	1/2007	Macchi	D2/706
D578,277	S	10/2008	Lung		
D597,278	S	8/2009	Cavosie		
7,882,569	B2 *	2/2011	Liu	2/67
D643,179	S	8/2011	Naughton		
D643,594	S *	8/2011	Francucci et al.	D2/709
8,075,369	B2 *	12/2011	Hendrickson	450/86

8,176,572	B2 *	5/2012	Falla	2/400
8,506,349	B2 *	8/2013	Sobah-Wilhelm	450/57
2003/0013379	A1 *	1/2003	Henz	450/1
2009/0093190	A1	4/2009	Wooley		
2013/0084776	A1 *	4/2013	Walsh	450/57
2013/0237124	A1 *	9/2013	Hall	450/38
2014/0051331	A1 *	2/2014	Handras	450/89

* cited by examiner

Primary Examiner — Karen E Eldridge Powers

(74) *Attorney, Agent, or Firm* — QuickPatent; Kevin Prince

(57) **CLAIM**

I claim the ornamental design for a bra with interchangeable back strap, as shown and described.

DESCRIPTION

FIG. 1 is a rear perspective view of a bra with interchangeable back strap, showing my new design;
 FIG. 2 is an exploded rear perspective view thereof;
 FIG. 3 is a front elevational view of the design as shown in FIG. 1;
 FIG. 4 is a rear elevational view of the design as shown in FIG. 1;
 FIG. 5 is a left-side elevational view of the design as shown in FIG. 1, the right-side elevational view being a mirror image thereof;
 FIG. 6 is a top plan view thereof;
 FIG. 7 is a bottom plan view thereof; and,
 FIG. 8 is a front perspective view thereof, illustrated with the back strap in a flat configuration. The back strap is shown separately for clarity of illustration.
 The broken lines showing a person in FIG. 1 depict environmental matter and form no part of the claimed design. The finely-incremented broken lines shown on the back strap are lines of stitching.

1 Claim, 4 Drawing Sheets

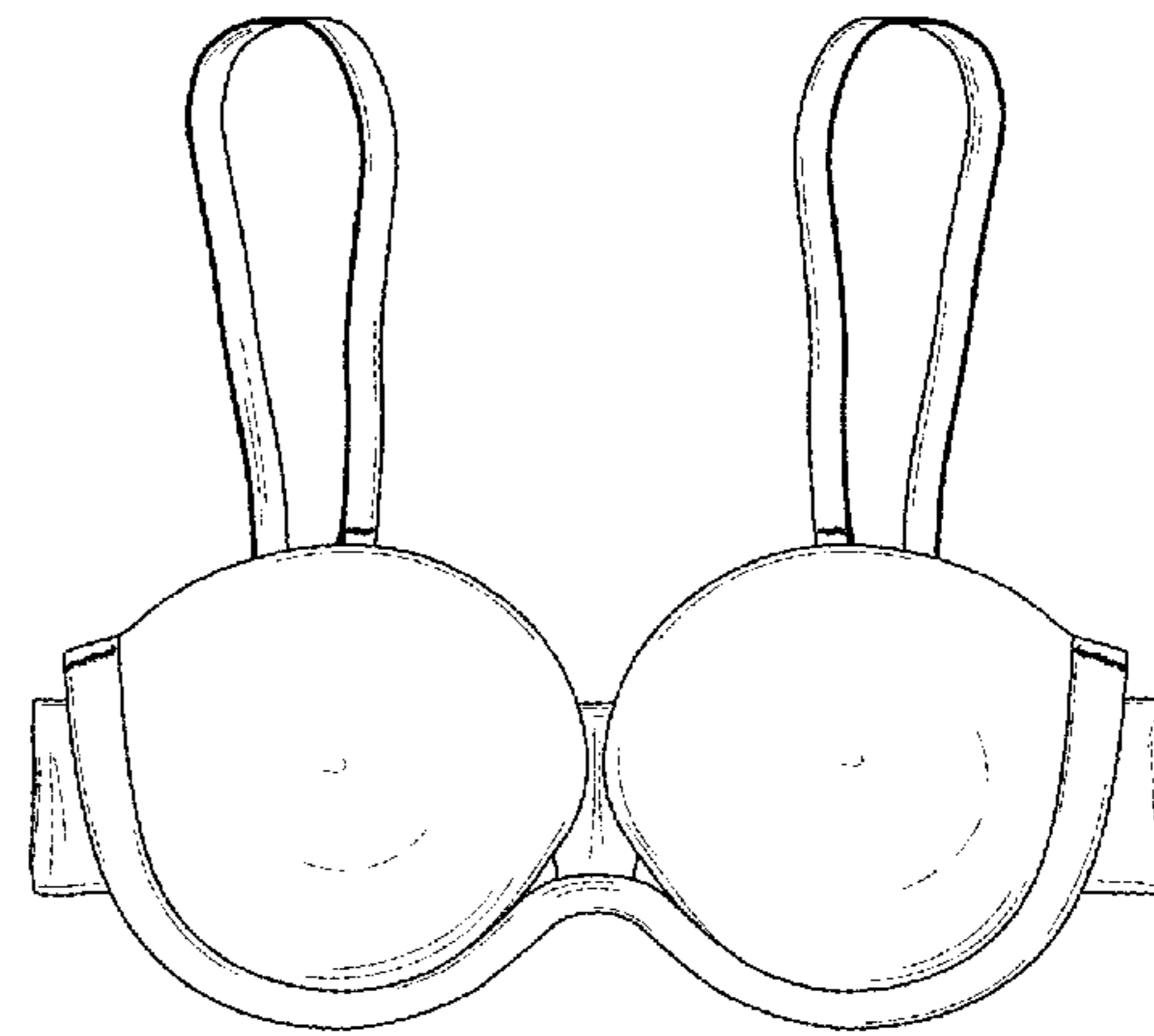
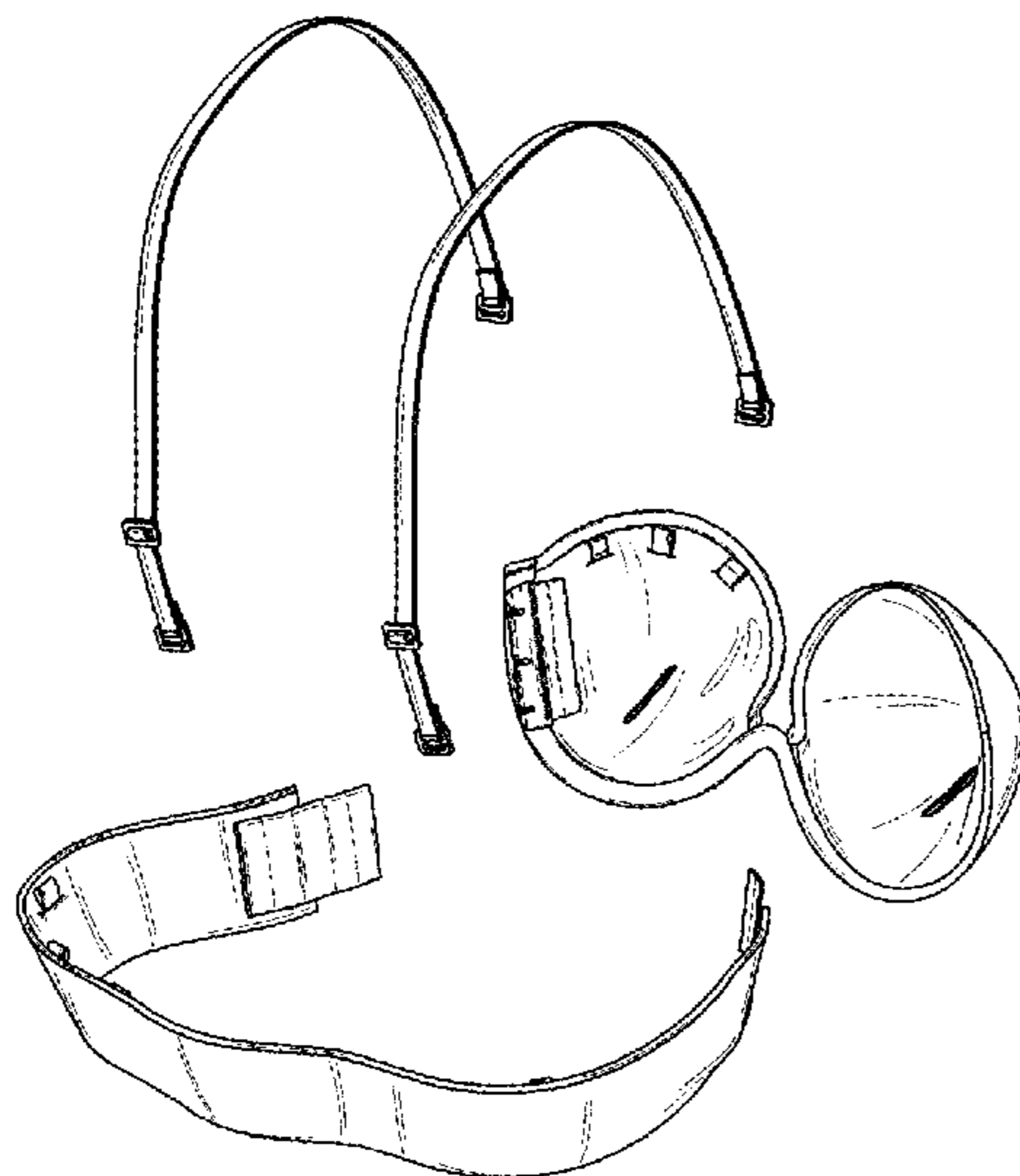

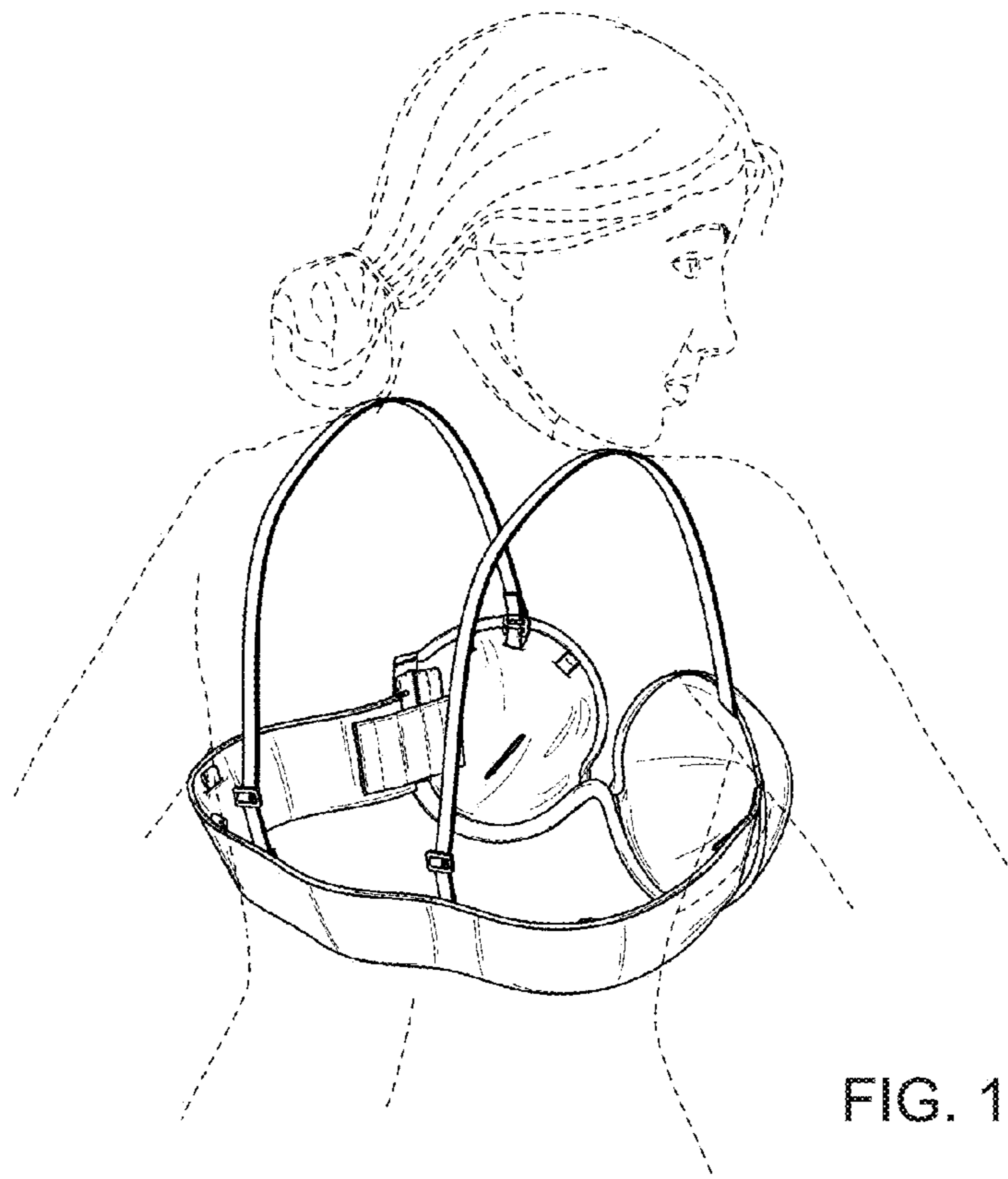

FIG. 1

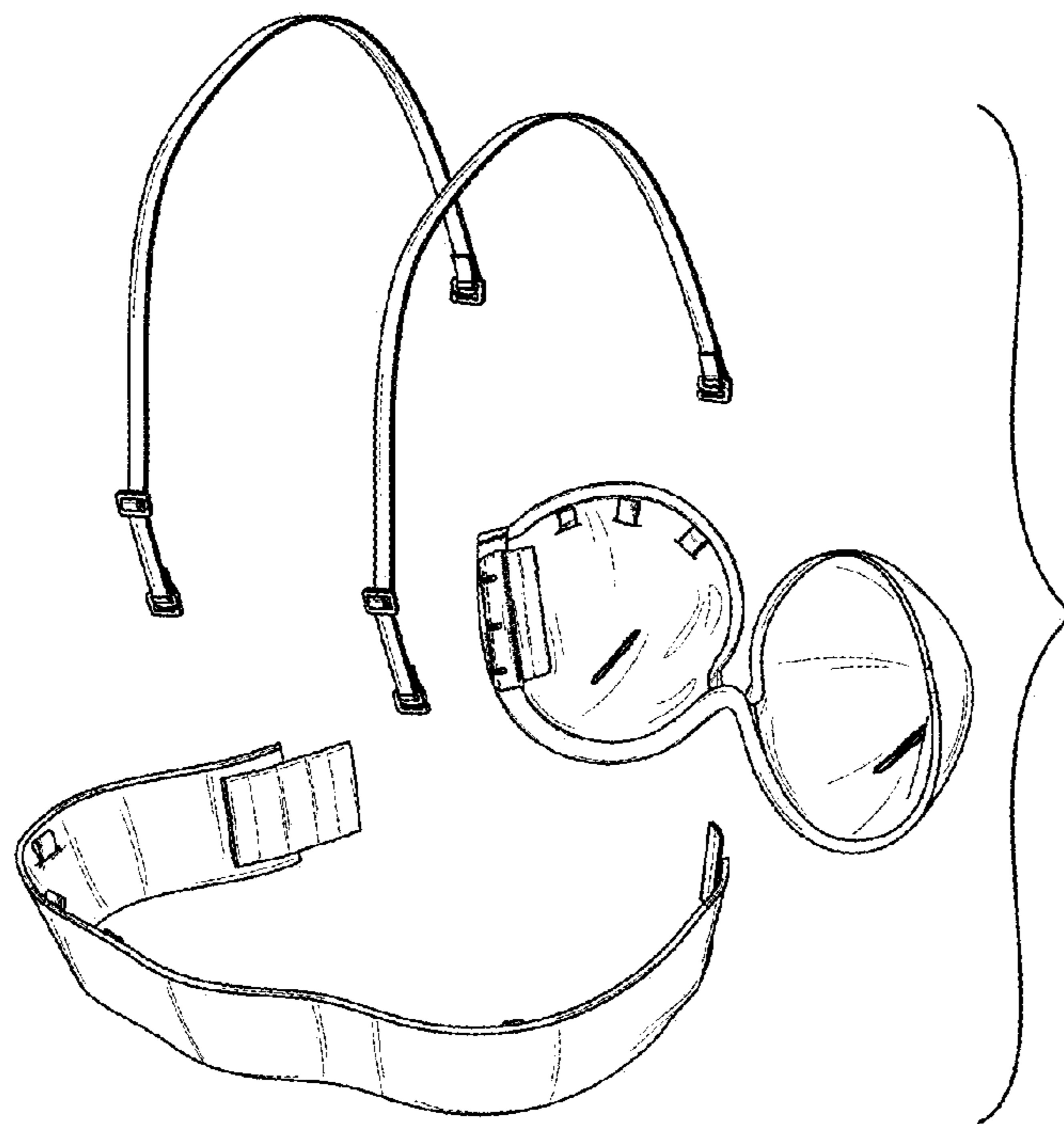

FIG. 2

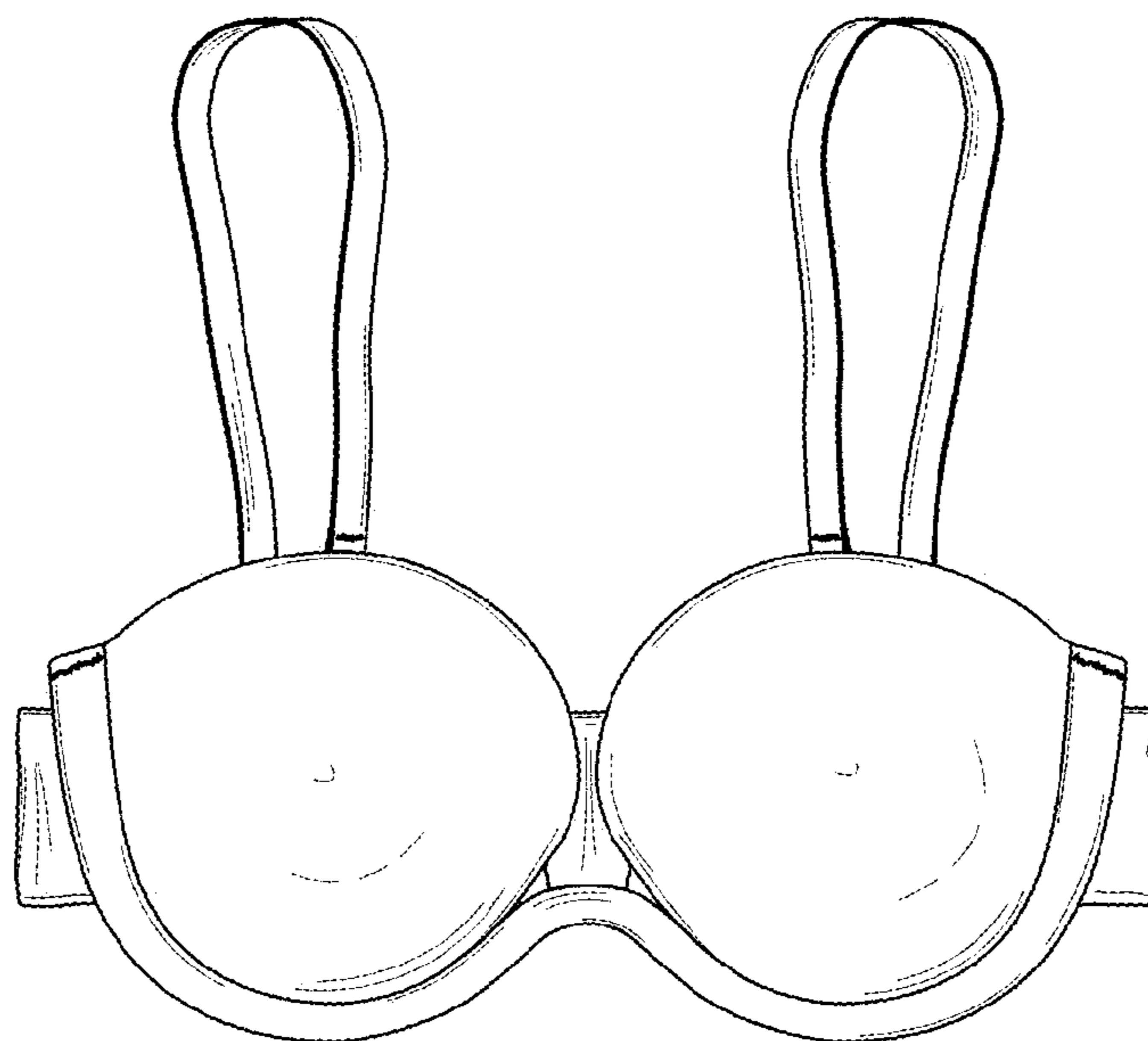

FIG. 3

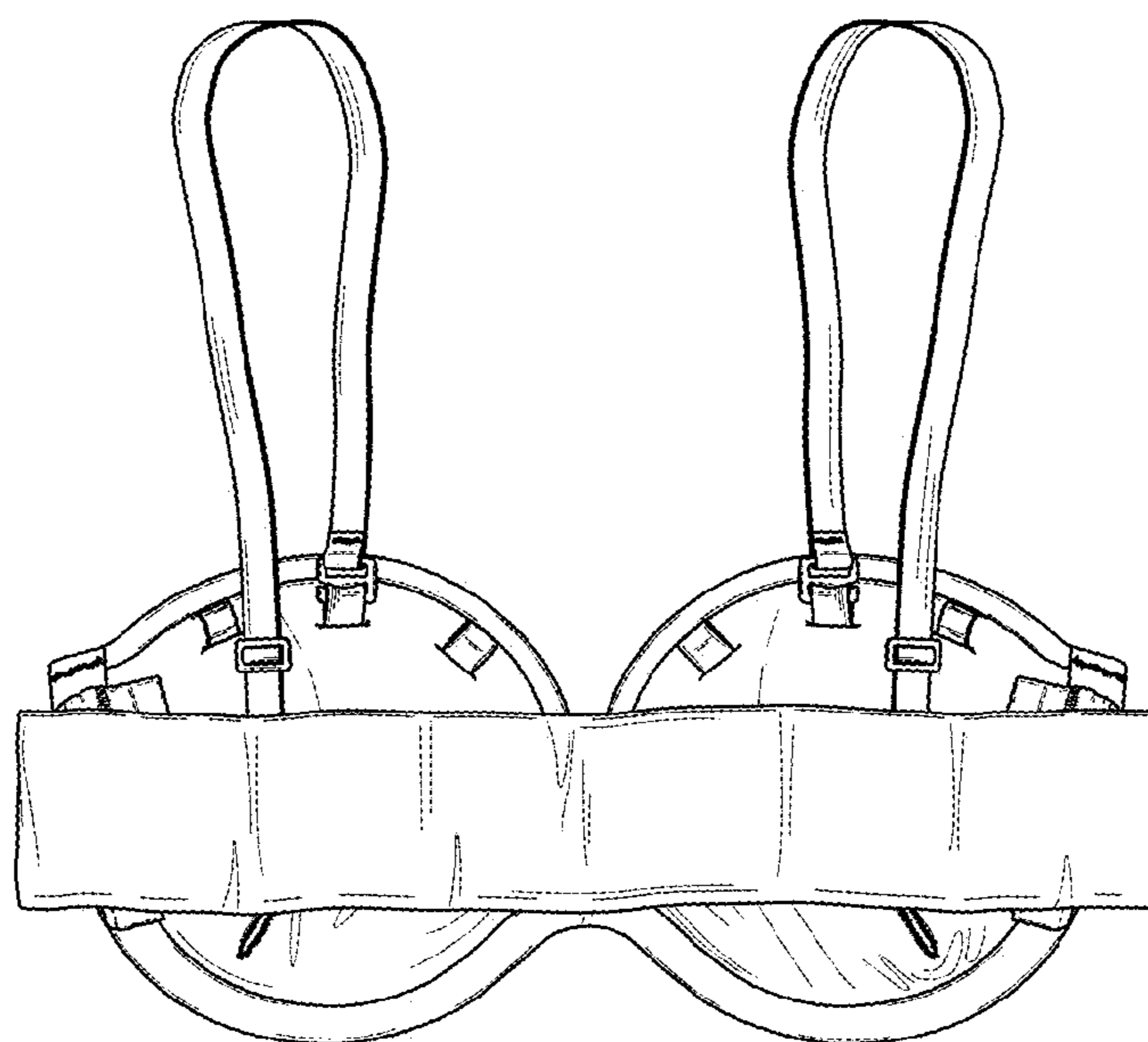

FIG. 4

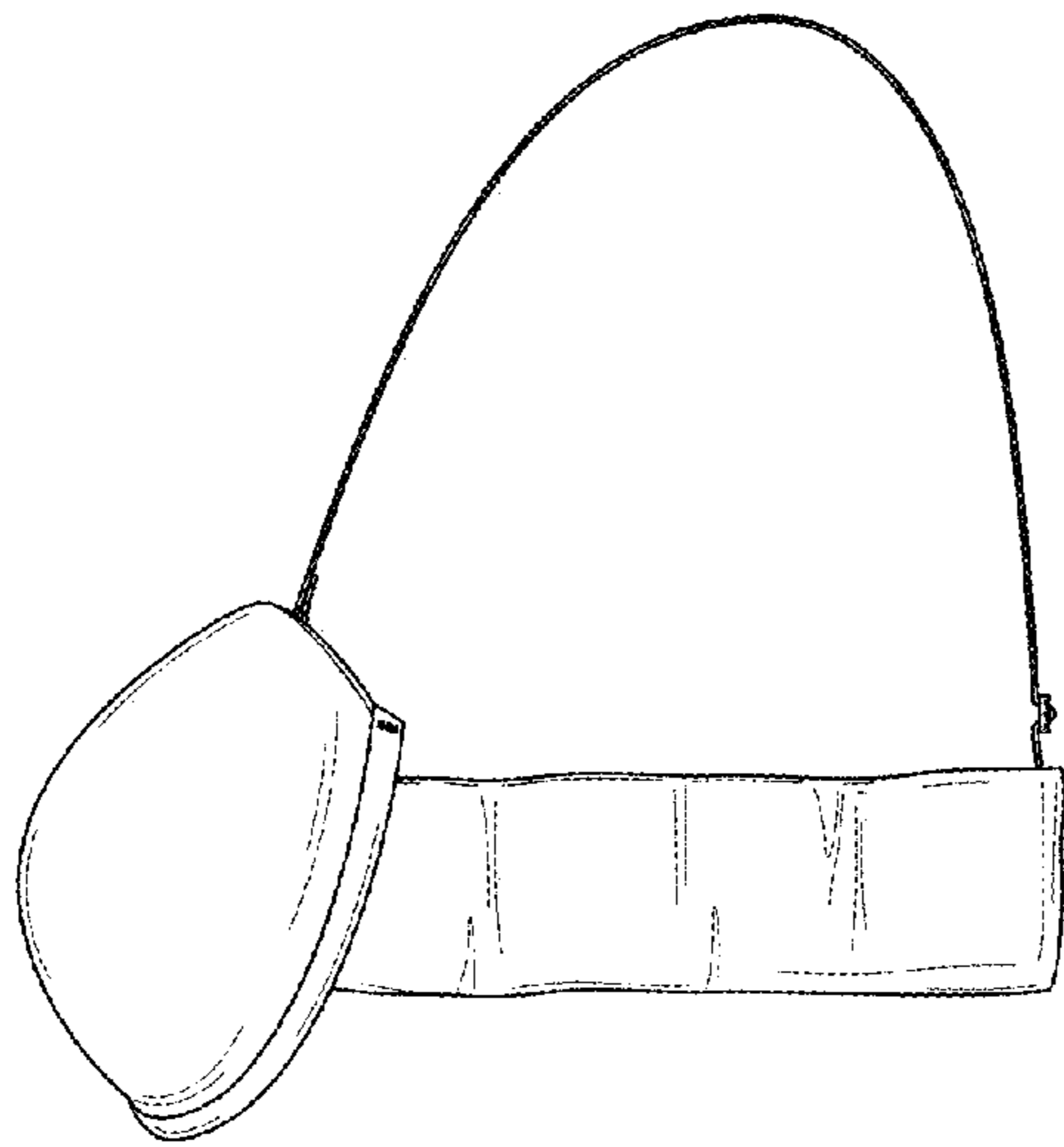

FIG. 5

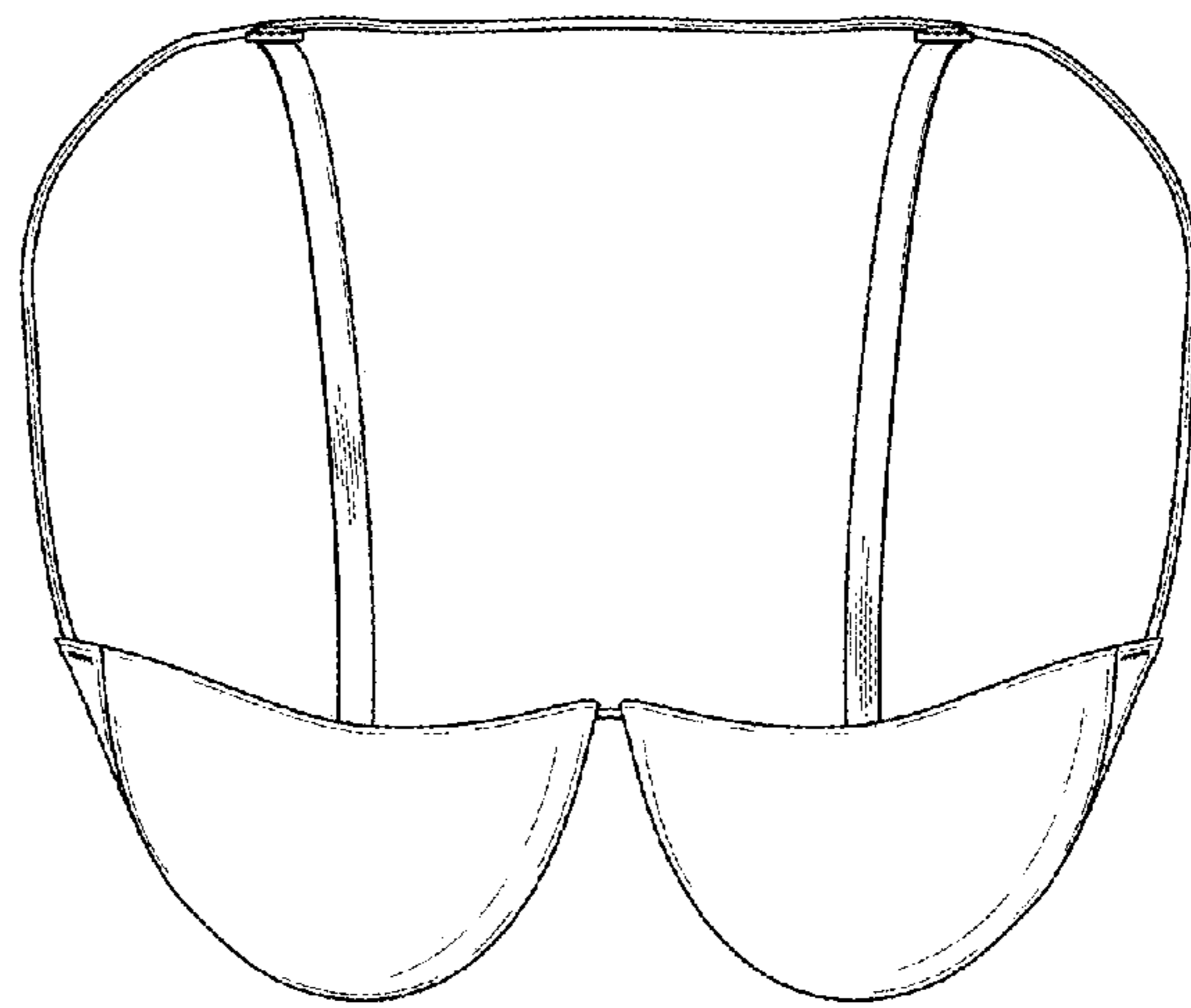

FIG. 6

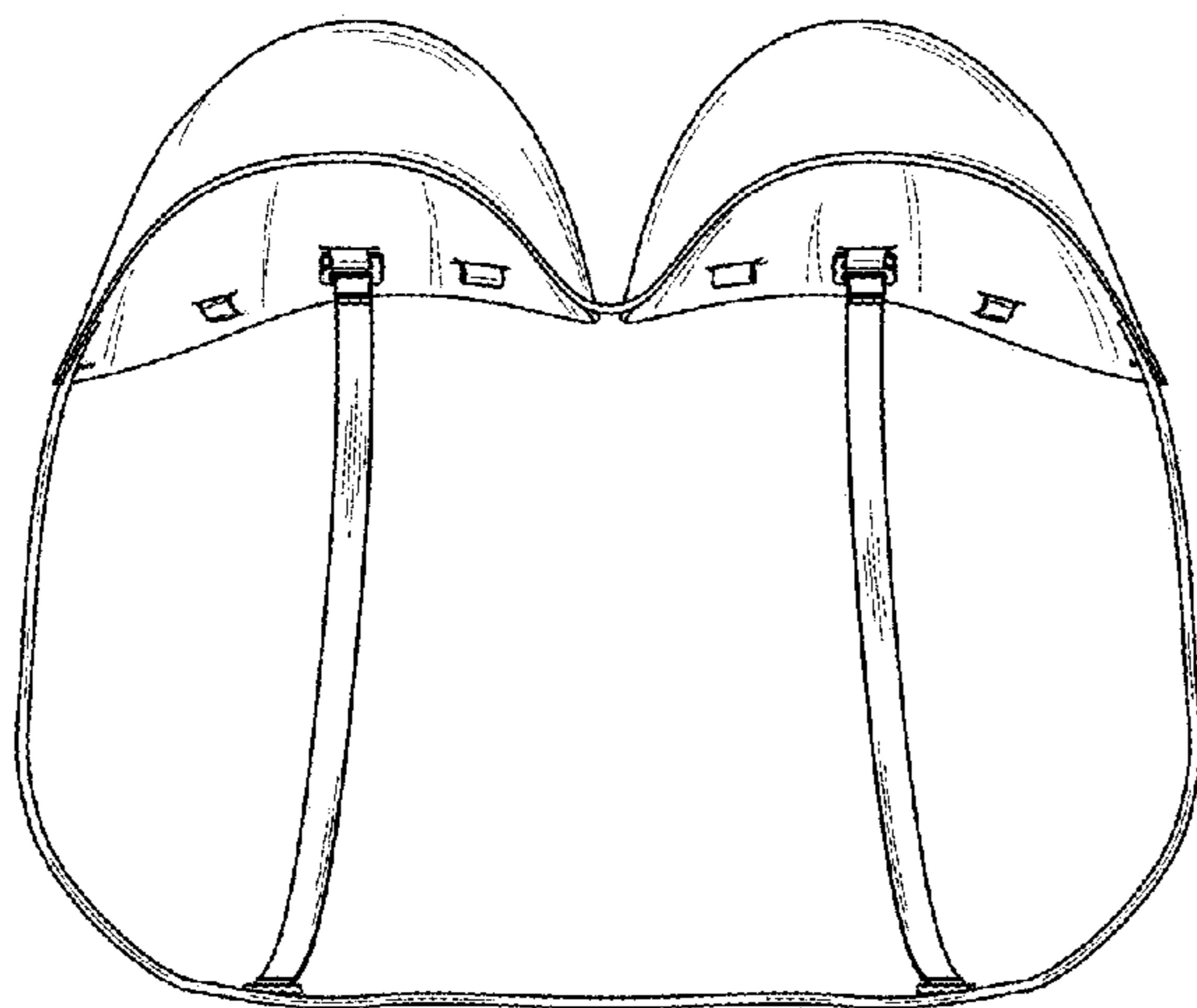

FIG. 7

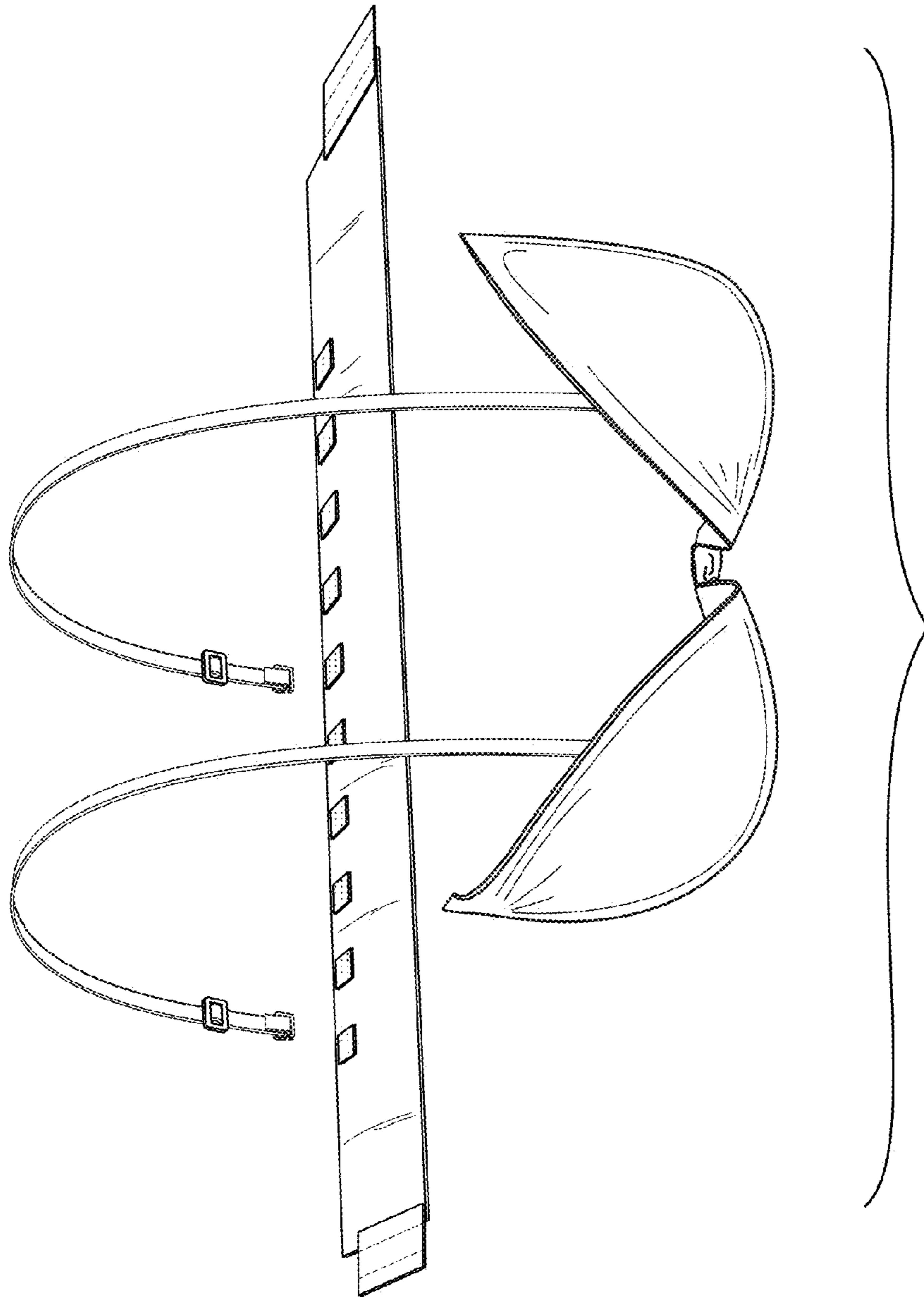

FIG. 8