



US00D709599S

(12) **United States Design Patent**  
**Lobley et al.**

(10) **Patent No.:** **US D709,599 S**  
(45) **Date of Patent:** **\*\* Jul. 22, 2014**

(54) **OUTDOOR SHOWER**

(71) Applicants: **James N Lobley**, Greenfield, MA (US);  
**Kirsten E Oxboel**, Greenfield, MA (US)

(72) Inventors: **James N Lobley**, Greenfield, MA (US);  
**Kirsten E Oxboel**, Greenfield, MA (US)

(73) Assignee: **Oborain, LLC**, Greenfield, MA (US)

(\*\*) Term: **14 Years**

(21) Appl. No.: **29/454,408**

(22) Filed: **May 9, 2013**

(51) **LOC (10) Cl.** ..... **23-02**

(52) **U.S. Cl.**  
USPC ..... **D23/283**

(58) **Field of Classification Search**  
USPC ..... D23/275, 283, 303-307, 228, 213;  
4/552, 596, 661, 599, 600; D6/640;  
D25/16; D21/837-839

See application file for complete search history.

(56) **References Cited**

U.S. PATENT DOCUMENTS

3,208,083	A	9/1965	Witzak	
D221,771	S	9/1971	Le Blanc et al.	
3,629,875	A *	12/1971	Dow et al.	4/599
D268,308	S *	3/1983	Milani	D6/583
4,807,310	A	2/1989	Sedala	
4,975,992	A	12/1990	Patterson et al.	
4,993,201	A	2/1991	Bunyard	
5,331,778	A	7/1994	Mazpule et al.	
5,544,369	A	8/1996	Roberts	
5,920,927	A	7/1999	Thomas	
5,970,536	A	10/1999	Suarez	
D444,215	S	6/2001	Schanz et al.	
D500,356	S	12/2004	Haug et al.	
D564,625	S *	3/2008	Bickler et al.	D23/228
7,946,307	B2	5/2011	Zheng	
7,979,926	B1	7/2011	Boegler	
8,109,044	B2 *	2/2012	Graber	52/36.2

D673,659	S	1/2013	Collins, IV
2008/0040851	A1	2/2008	Jackson
2010/0293868	A1	11/2010	Holzworth
2011/0094027	A1	4/2011	Barney et al.

FOREIGN PATENT DOCUMENTS

GB 0 107 960 A1 5/1984

OTHER PUBLICATIONS

Samantha Emmerling: "101 Kitchen and Bath Updates"; House Beautiful Feb. 2013 edition, p. 87; Hearst Corporation; New York NY. Editorial: "Outdoor Showers Are A Bit Of Luxury In Your Own Back Yard"; dornob Design Ideas Daily, dornob.com, Jan. 2013, Internet Brands, Inc., USA.

Nigel F. Maynard: "Oborain Outdoor Shower"; Builder Magazine; online edition Dec. 2012; Hanley Wood, LLC, Washington, DC.

Mick Tan: "Panelized Shower: Oborain pre-fab outdoor shower"; hotelmanagement.net: bath; online ed., Dec. 2012 Questex Media Group, LLC, Skokie, IL.

Nigel F. Maynard: "Oborain Outdoor Shower"; Residential Architect Magazine online edition Nov/Dec. 2012; Hanley Wood, LLC; Washington, DC.

(Continued)

*Primary Examiner* — Robert Delehanty

(74) *Attorney, Agent, or Firm* — George L. Goodridge

(57) **CLAIM**

The ornamental design for an outdoor shower, as shown and described.

**DESCRIPTION**

FIG. 1 is a perspective view of a shower showing our new design;

FIG. 2 is a front elevational view thereof;

FIG. 3 is a left side elevational view thereof;

FIG. 4 is a right side elevational view thereof;

FIG. 5 is a rear elevational view thereof;

FIG. 6 is a top plan view thereof; and,

FIG. 7 is a bottom plan view thereof.

**1 Claim, 4 Drawing Sheets**

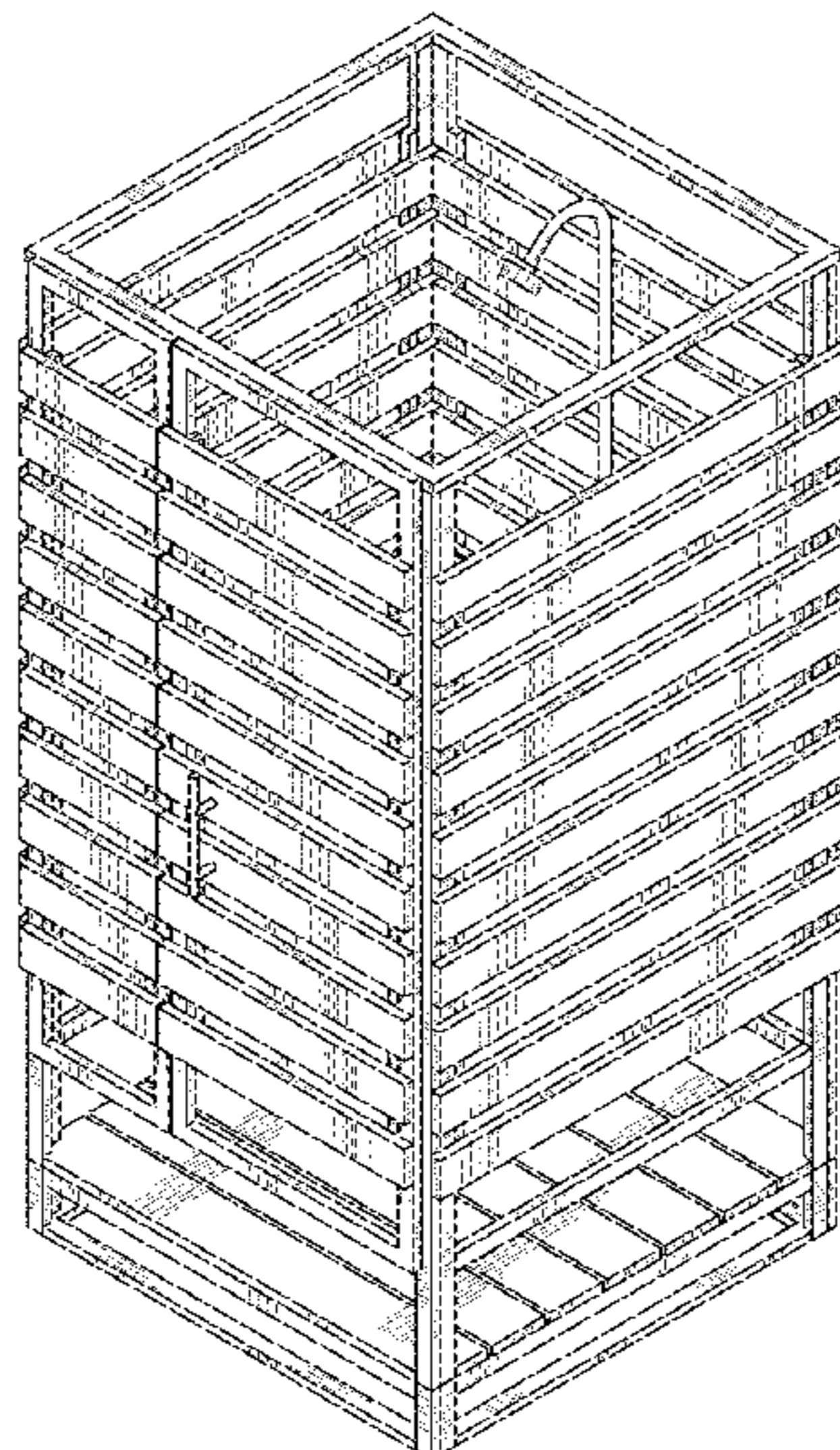

(56)

**References Cited**

## OTHER PUBLICATIONS

Editorial: "Product Spotlight: Outdoor Bathing"; Dwell Bath & Spa Special Issue, Fall 2012, p. 161; Dwell Magazine, Dwell Media, New York, NY.

Editorial: md International designsout for furniture, interior and design; Nov. 2012 ed., p. 75, Konradin Verlag R. Kohlhammer GmbH, Leinfelden-Echterdingen, Germany.

Editorial: "Outdoor Shower—Oberain"; OnOffice online magazine; Nov. 2012 edition; London, UK.

Editorial: "Modcoach Finds Perfect Acquisition for Blu Homes"; Modular Home Builder online blog; modularhomecoach.com; Nov. 19, 2012; USA.

Editorial: "Spa Appointments: Bliss Out in the Bath"; Interior Design Market Tabloid, Kitchen & Bath section Oct. 2012, p. 186(?), Sandow Media, LLC, New York, NY.

Mary Beth Breckenridge: "Outdoor Showers Go Upscale"; The Miami Herald newspaper online edition; Oct. 19, 2012; McClatchy Company, Miami, FL.

Chris Wright: "Bathers Without Borders: Oberain Outdoor Shower"; Gear Patrol online magazine; Oct. 2012; Say Media, Inc.; San Francisco, CA.

Editorial: "Outdoor Products"; Custom Home Outdoors: A Supplement to Custom Home, Fall 2012 edition, p. XX; Custom Home; Hanley Wood, LLC, Washington, DC.

Maria Newman: "An Outdoor Shower That Only Looks Permanent"; New York Times newspaper, Home & Garden section; Sep. 21, 2012; New York Times Company, New York, NY.

David Keeps: "Dwell On Design: Mod Must-Haves"; Garden Design magazine, Oct. 9, 2012 online edition, pp. 1-7; Bonnier Corp., Winter Park, FL.

Caroline Williamson: "A Modern Pre-Fab Outdoor Shower"; design-milk.com online magazine/Home Furnishings, pp. 107, Sep. 12, 2012; JD2 Media, LLC, Cherry Hill, NJ.

Editorial: "Oberain, A Pretty Prefab Outdoor Shower"; Notcot.org for your ideas +aesthetics+amusement online blog, Sep. 2012; Notcot, Inc., Los Angeles, CA.

Kimberley Mok: "Sleek & Sustainable Prefab Outdoor Shower Assembles in 30 Minutes"; treehugger online magazine; Sep. 2012; Mother Nature Network, Atlanta GA.

Editorial: "Oberain, the first modern pre-fab outdoor shower"; designerpages.com/3rings online magazine; Sep. 2012; Designer Pages Online, LLC, New York, NY.

Editorial: "Peco: Na powietrzu"; Kultura section, Purpose online magazine; Sep. 2012 edition, Evolution Media Net, Warsaw, Poland.

Editorial: "Modern Prefab Outdoor Shower"; Landscaping Network online magazine; Aug. 2012; LandscapingNetwork.com, Calimesa, CA.

Michael J. Rocha: "Dwell on Design: The Art Of Loving Modern"; San Diego Union-Tribune online newspaper; Jun. 2012, San Diego Union-Tribune, LLC, San Diego, CA.

Jaime Gillin: "Dwell on Design: Outdoor Focus"; Dwell: At Home In The Modern World Magazine (online); Jun. 2012; Dwell, LLC, San Francisco, CA.

Sandy Keenan: "An Outdoor Shower Inspired by P.S. 122"; NY Times newspaper/Home & Garden section, p. 1-2; Jul. 31, 2013; New York Times Company, New York, NY.

Ingrid Abramovitch: "What the Pros Know: Waterside Retreats"; Elle Decor Magazine; online edition, p. 6; Hearst Corporation; Jun. 2013.

Courtney Kasianowicz: "Local Wares: Clean Sweep", Design New England magazine; p. 84, May/Jun. 2013 edition, Boston Globe Media, Boston, MA.

\* cited by examiner



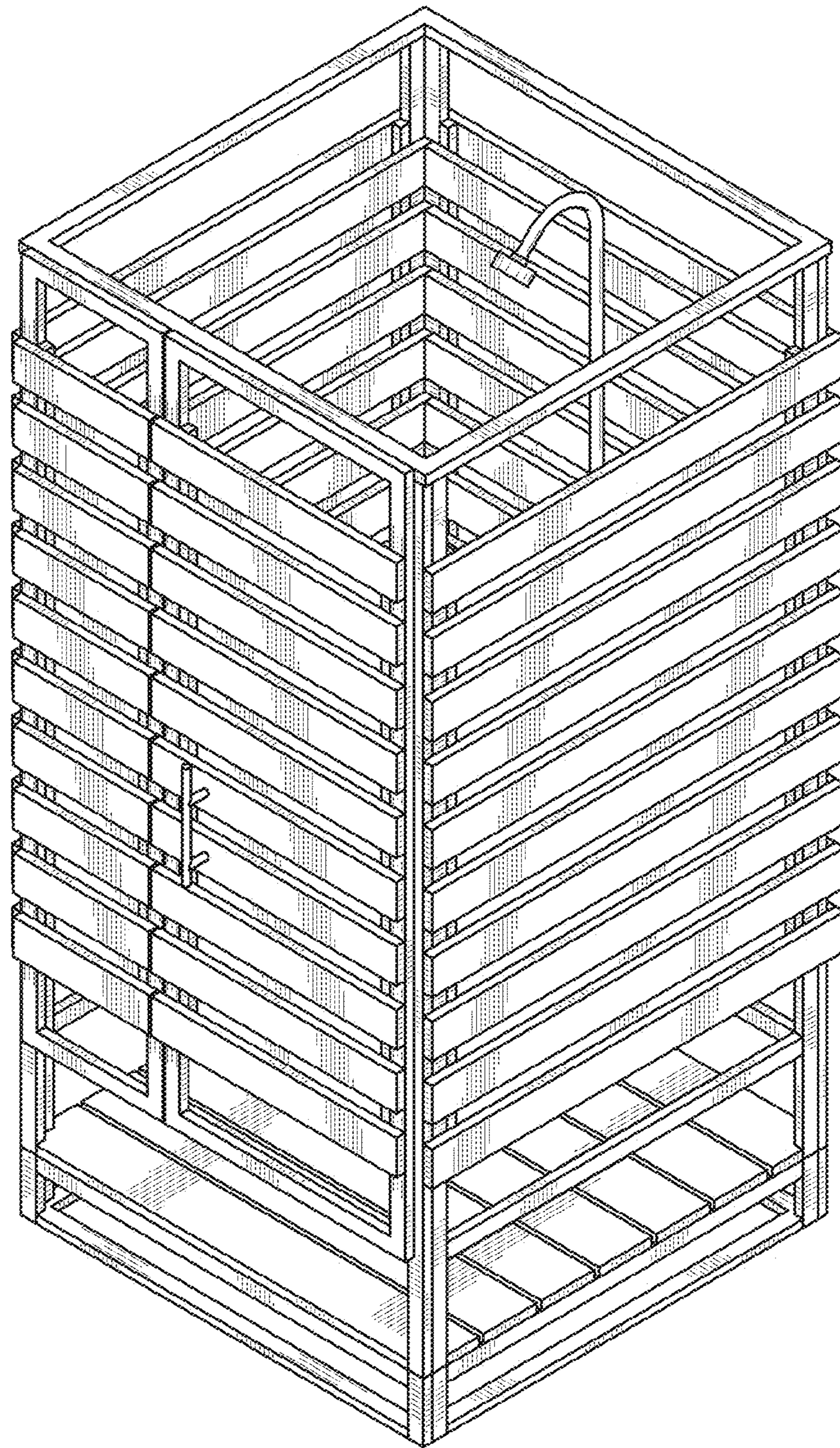

FIG. 1



FIG. 3

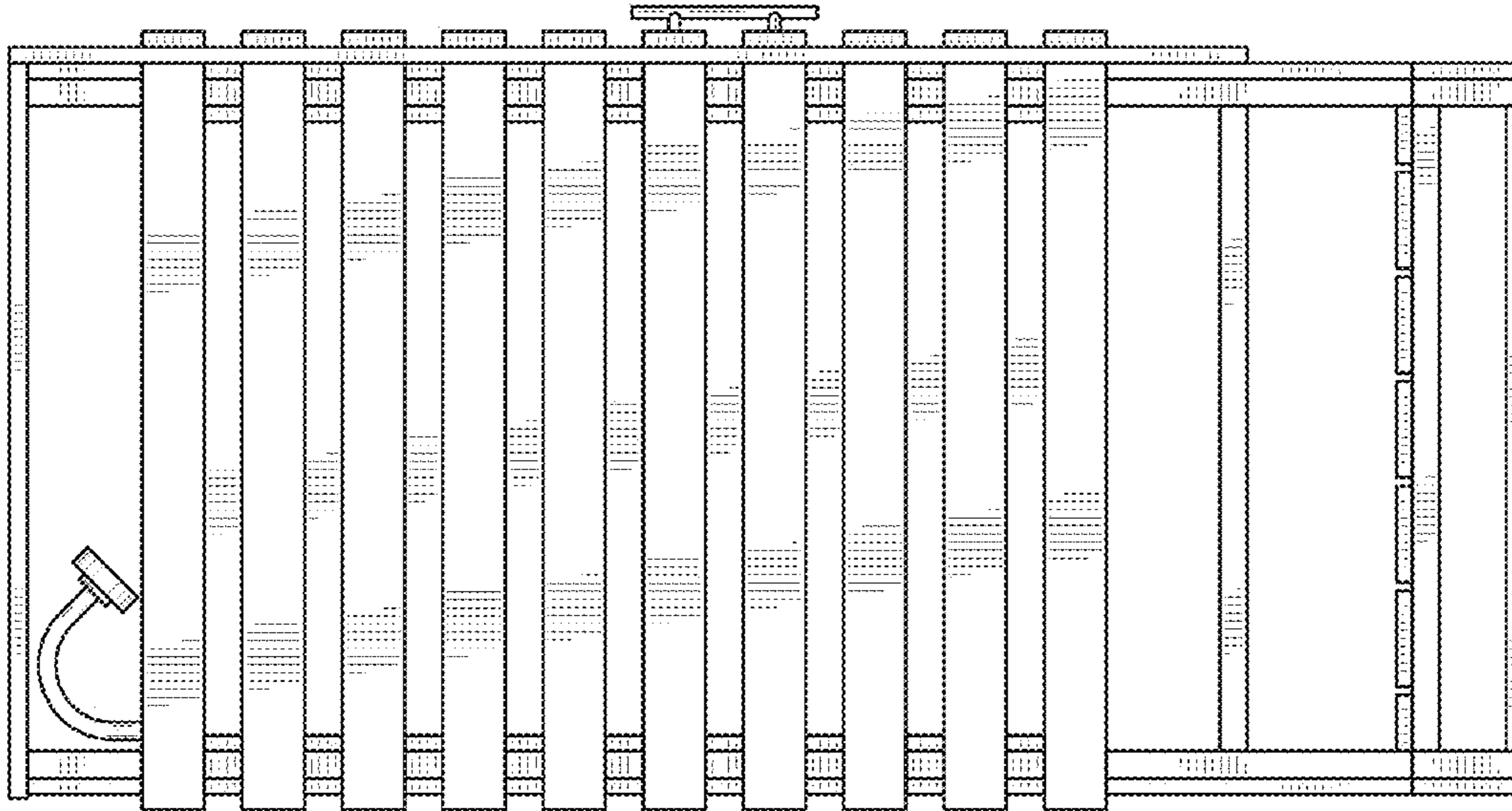

FIG. 2

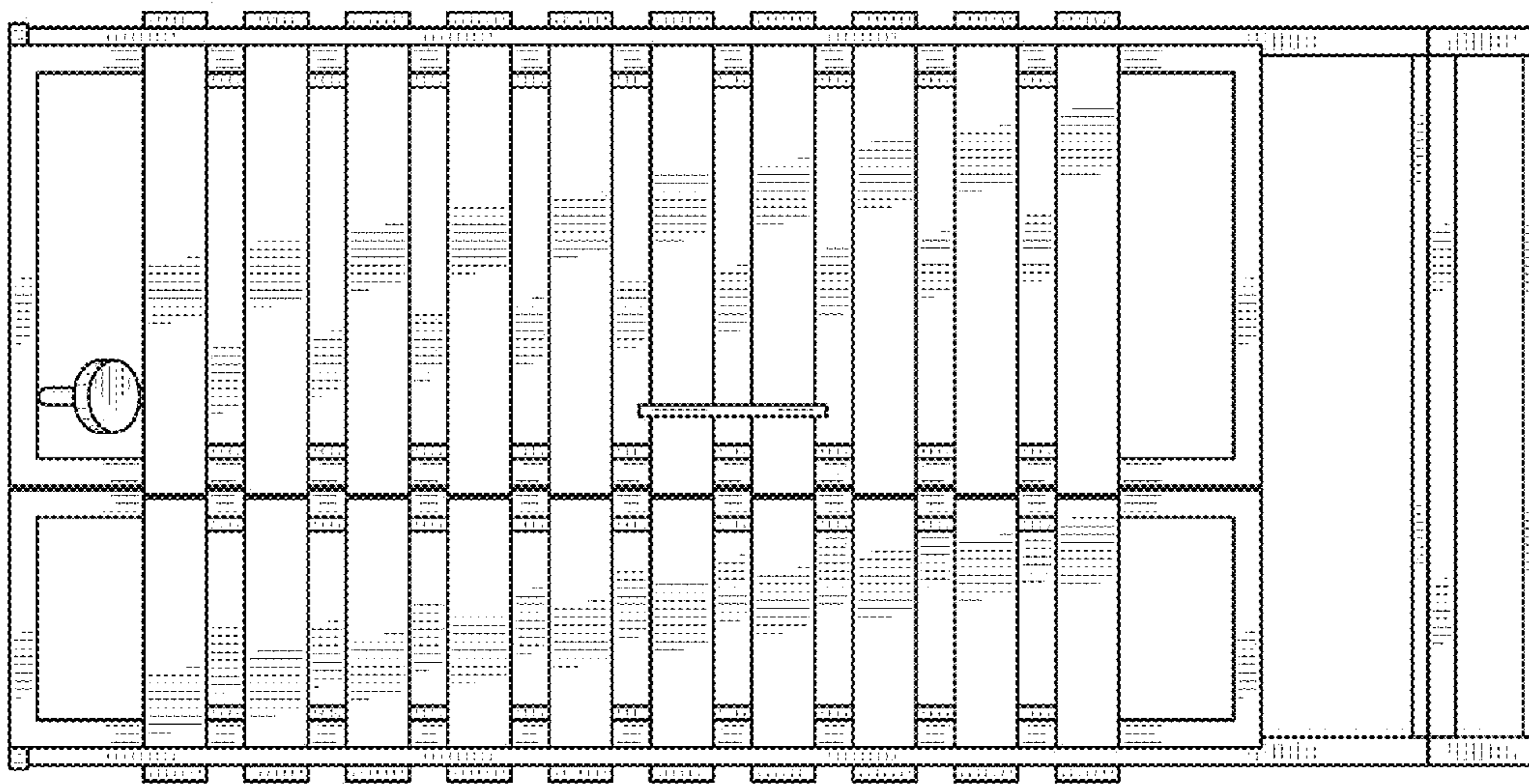

FIG. 5

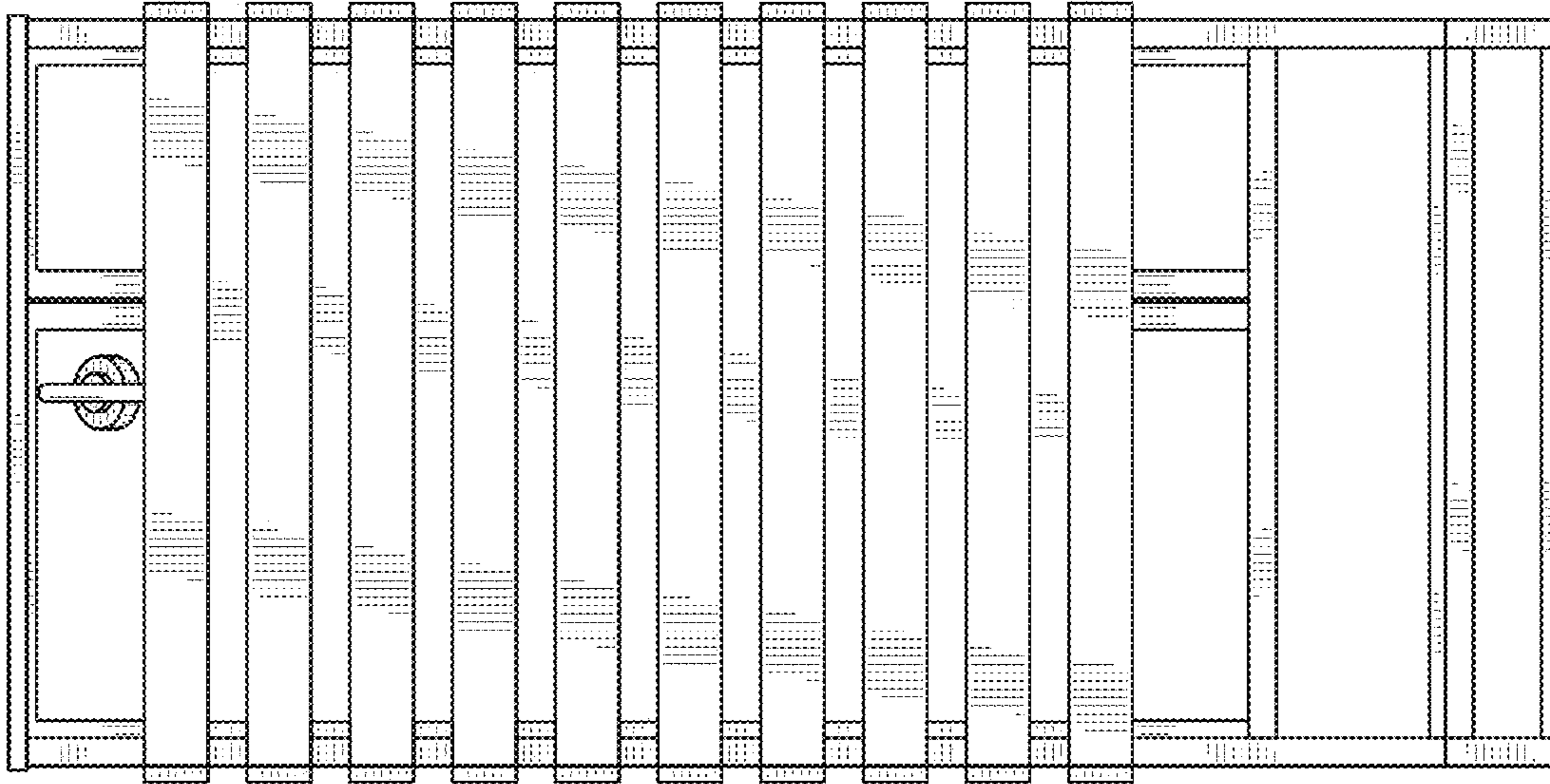
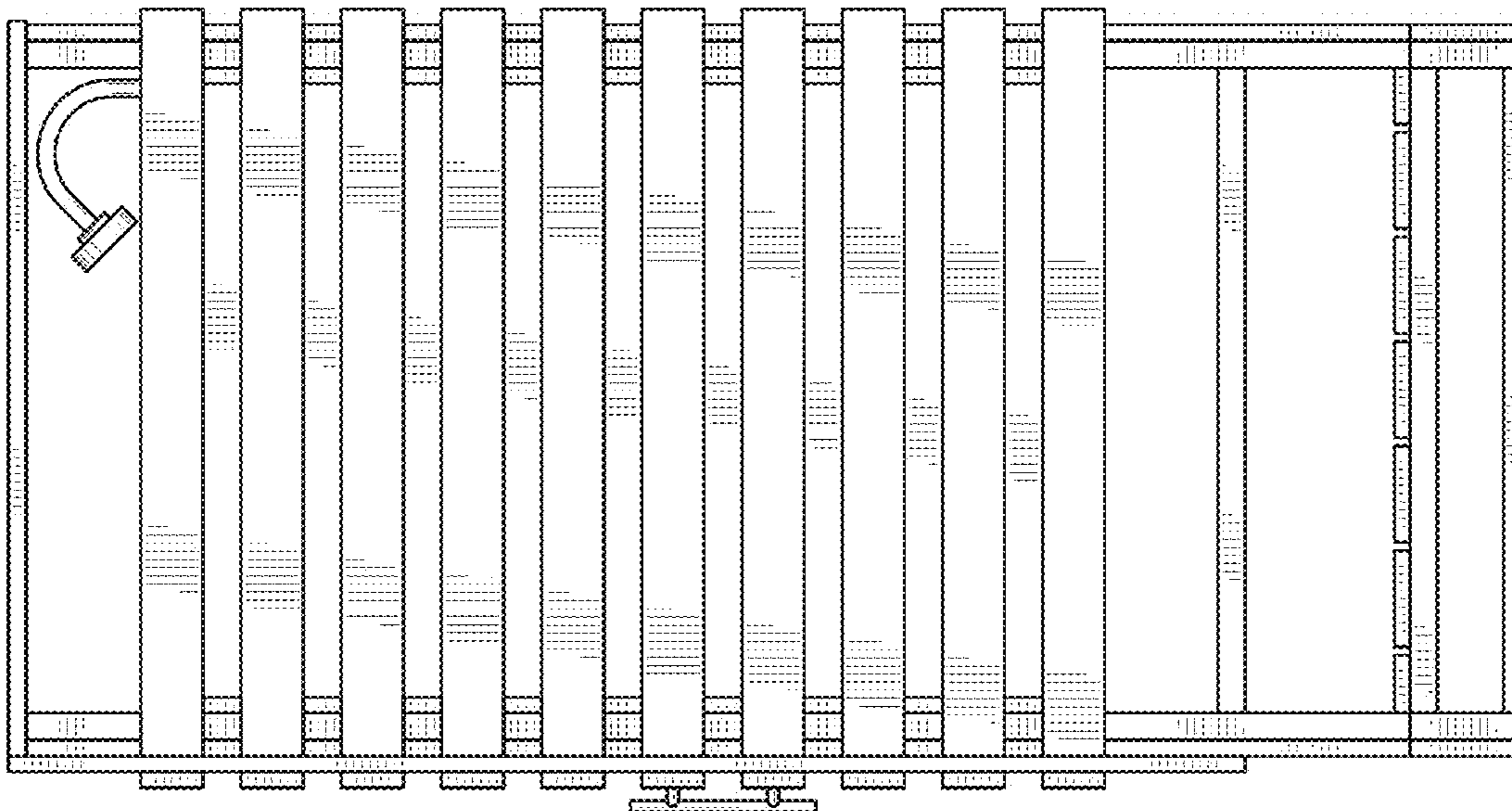

FIG. 4



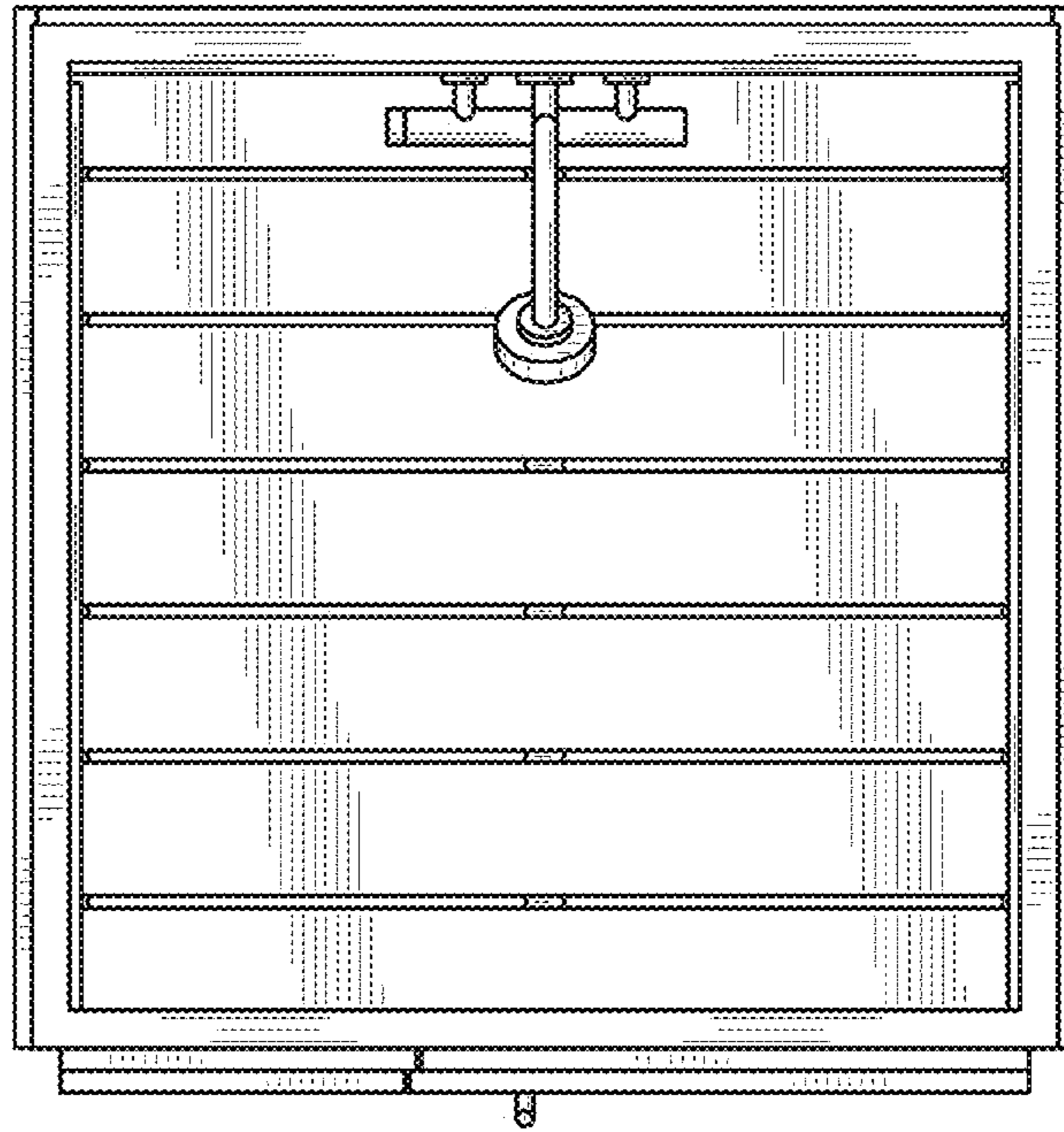

FIG. 6

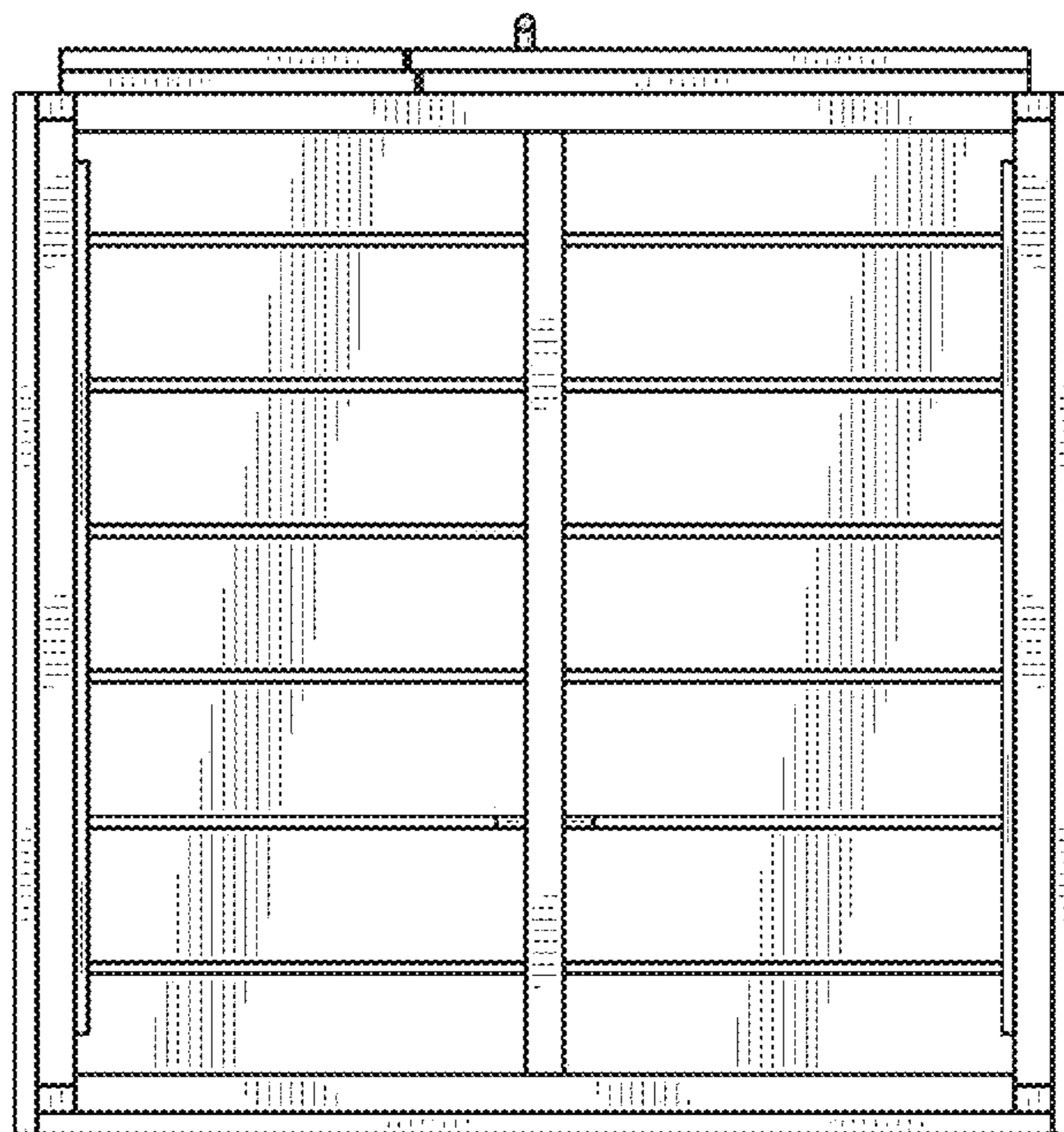

FIG. 7