



US00D709585S

(12) **United States Design Patent**  
**Klecker et al.**

(10) **Patent No.:** **US D709,585 S**  
(45) **Date of Patent:** **\*\* Jul. 22, 2014**

- (54) **LASER GRIP DEVICE**
- (71) Applicant: **Crimson Trace, Inc.**, Wilsonville, OR (US)
- (72) Inventors: **Glenn Klecker**, Wilsonville, OR (US); **Drew Essig**, Portland, OR (US); **Christopher John Murray**, Philadelphia, PA (US); **Jeffrey James Smith**, Honeoye Falls, NY (US)
- (73) Assignee: **Crimson Trace, Inc.**, Wilsonville, OR (US)
- (\*\*) Term: **14 Years**
- (21) Appl. No.: **29/443,185**
- (22) Filed: **Jan. 14, 2013**
- (51) **LOC (10) Cl.** ..... **22-01**
- (52) **U.S. Cl.**  
USPC ..... **D22/108**
- (58) **Field of Classification Search**  
USPC ..... D22/108-109; 42/111-128; 89/1.61, 89/200-204; 356/247-256  
See application file for complete search history.

- D669,958 S \* 10/2012 Essig et al. .... D22/108
- D687,120 S \* 7/2013 Hughes et al. .... D22/109
- D692,518 S \* 10/2013 Anderson et al. .... D22/109
- D694,848 S \* 12/2013 Anderson et al. .... D22/109
- D696,376 S \* 12/2013 Anderson et al. .... D22/109
- 2013/0074351 A1\* 3/2013 Kowalczyk et al. .... 33/286

**FOREIGN PATENT DOCUMENTS**

WO WO 02101315 A2 \* 12/2002  
\* cited by examiner

*Primary Examiner* — Michael A Pratt  
(74) *Attorney, Agent, or Firm* — Schwabe, Williamson & Wyatt, P.C.

(57) **CLAIM**  
We claim an ornamental design for a laser grip device, as shown and described.

**DESCRIPTION**

FIG. 1 is a perspective view of one embodiment of the present invention;  
FIG. 2 is a front view of the embodiment of FIG. 1;  
FIG. 3 is a rear view of the embodiment of FIG. 1;  
FIG. 4 is a right side view of the embodiment of FIG. 1;  
FIG. 5 is a left side view of the embodiment of FIG. 1 and the opposite side of FIG. 4;  
FIG. 6 is a top view of the embodiment of FIG. 1;  
FIG. 7 is a bottom view of the embodiment of FIG. 1; and,  
FIG. 8 is a side view of the embodiment of FIG. 1.  
The dashed lines are included for illustrating environmental structure and form no part of the claimed design.

**1 Claim, 8 Drawing Sheets**

- (56) **References Cited**  
**U.S. PATENT DOCUMENTS**  
D612,757 S \* 3/2010 D'Amelio et al. .... D10/70  
8,256,154 B2 \* 9/2012 Danielson et al. .... 42/146  
D669,552 S \* 10/2012 Essig et al. .... D22/108  
D669,957 S \* 10/2012 Hughes et al. .... D22/108

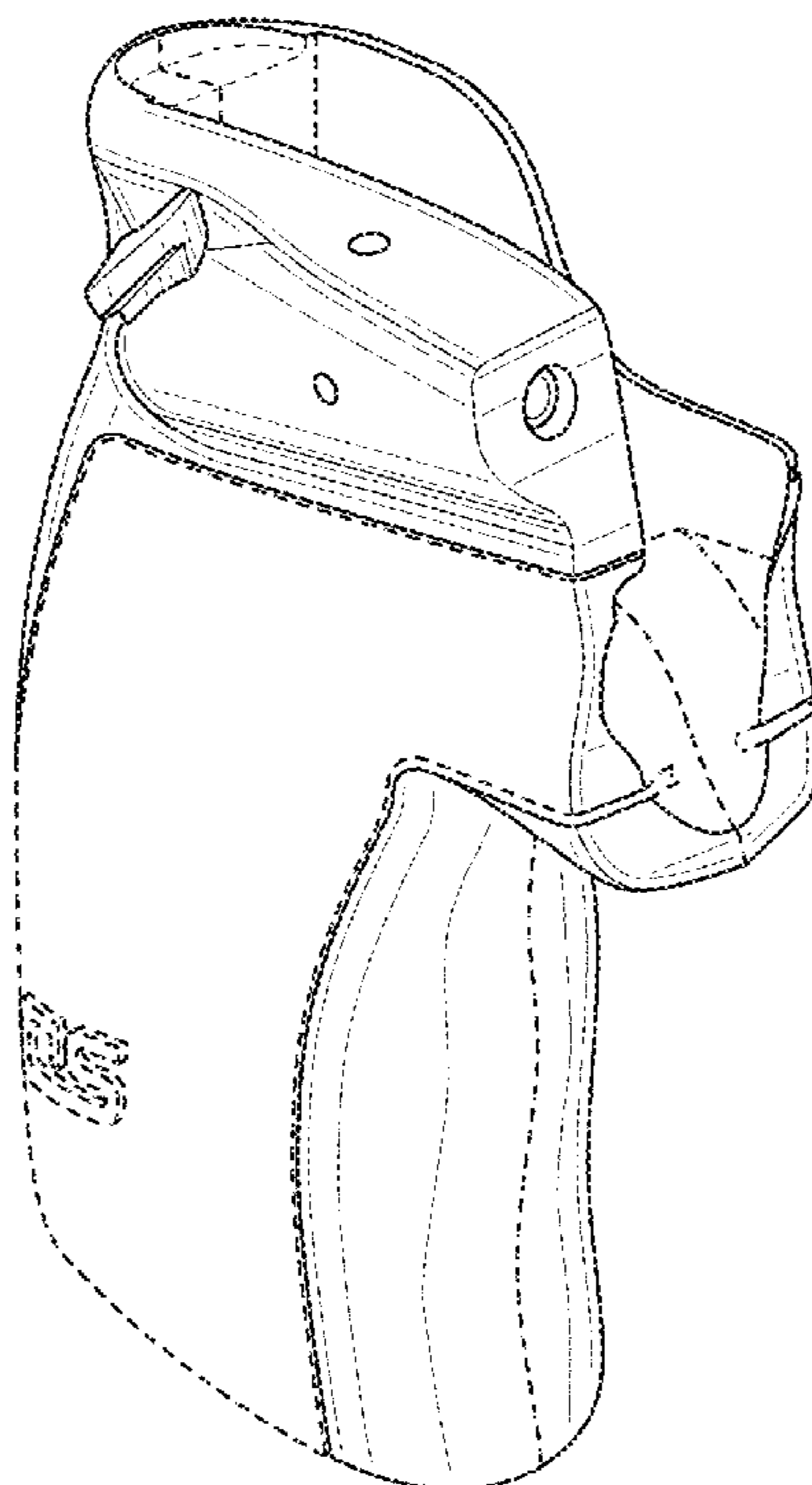

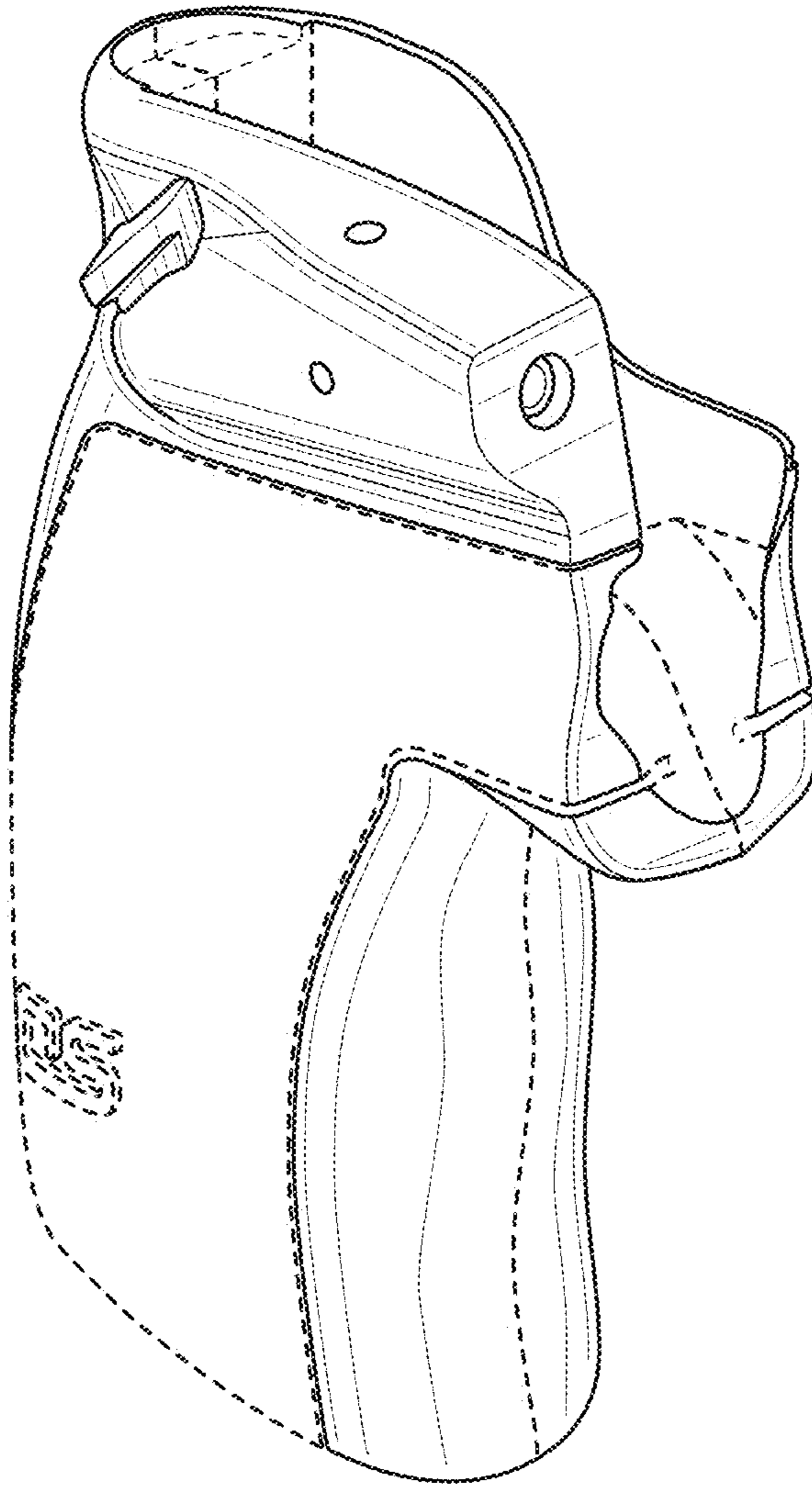

FIG. 1

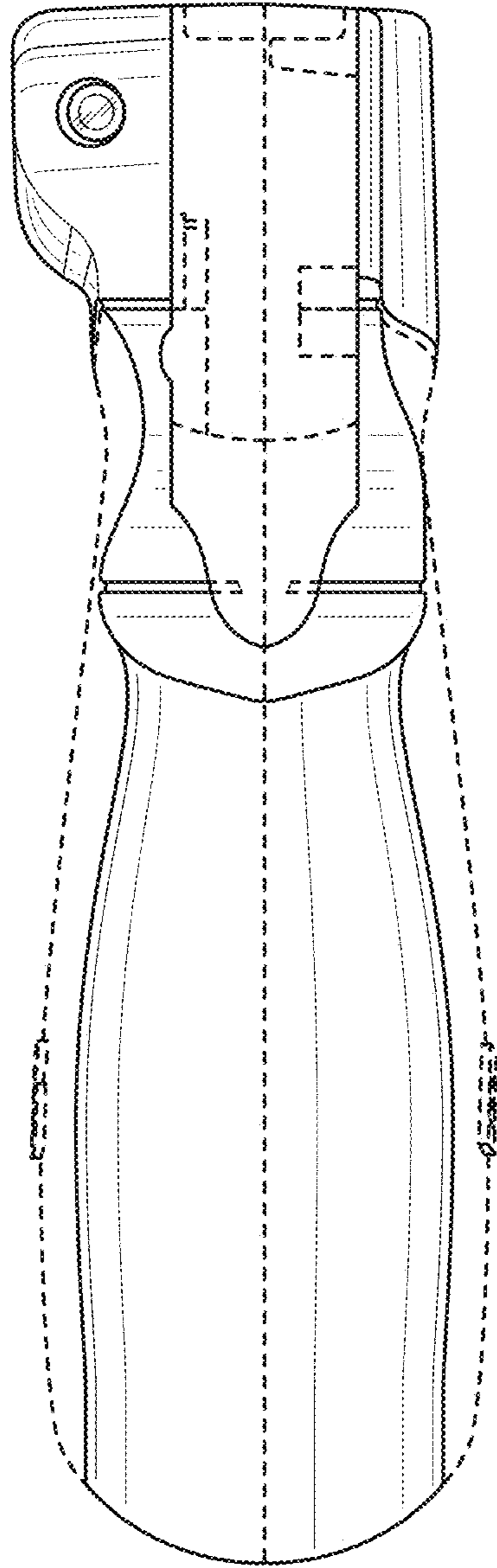

FIG. 2

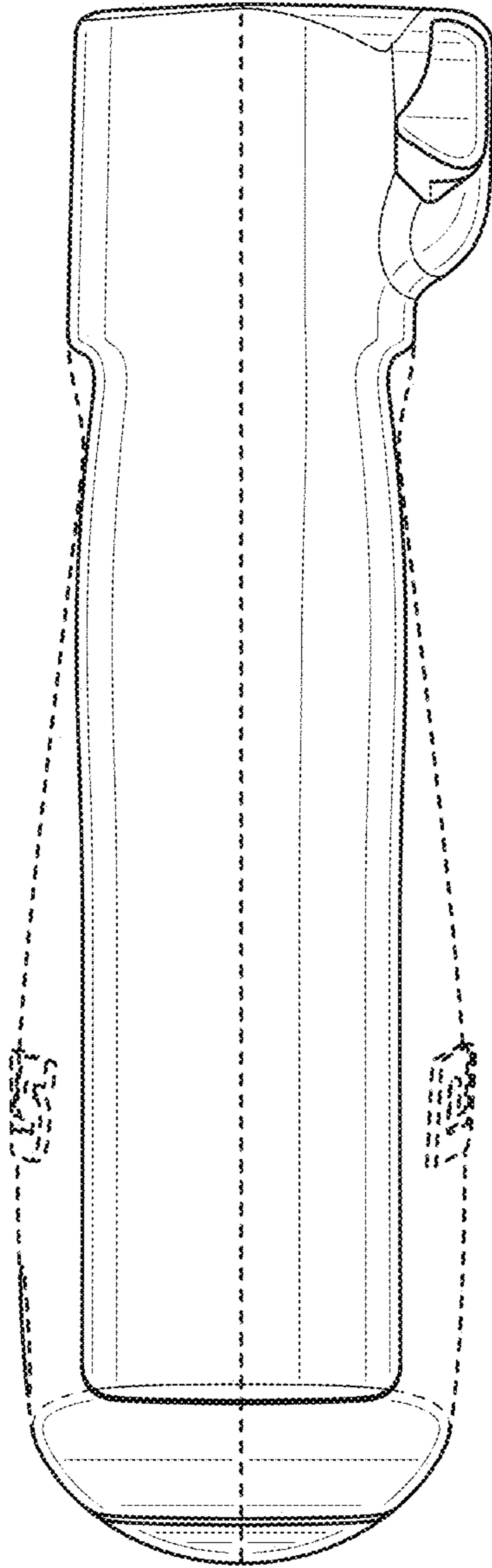

FIG. 3

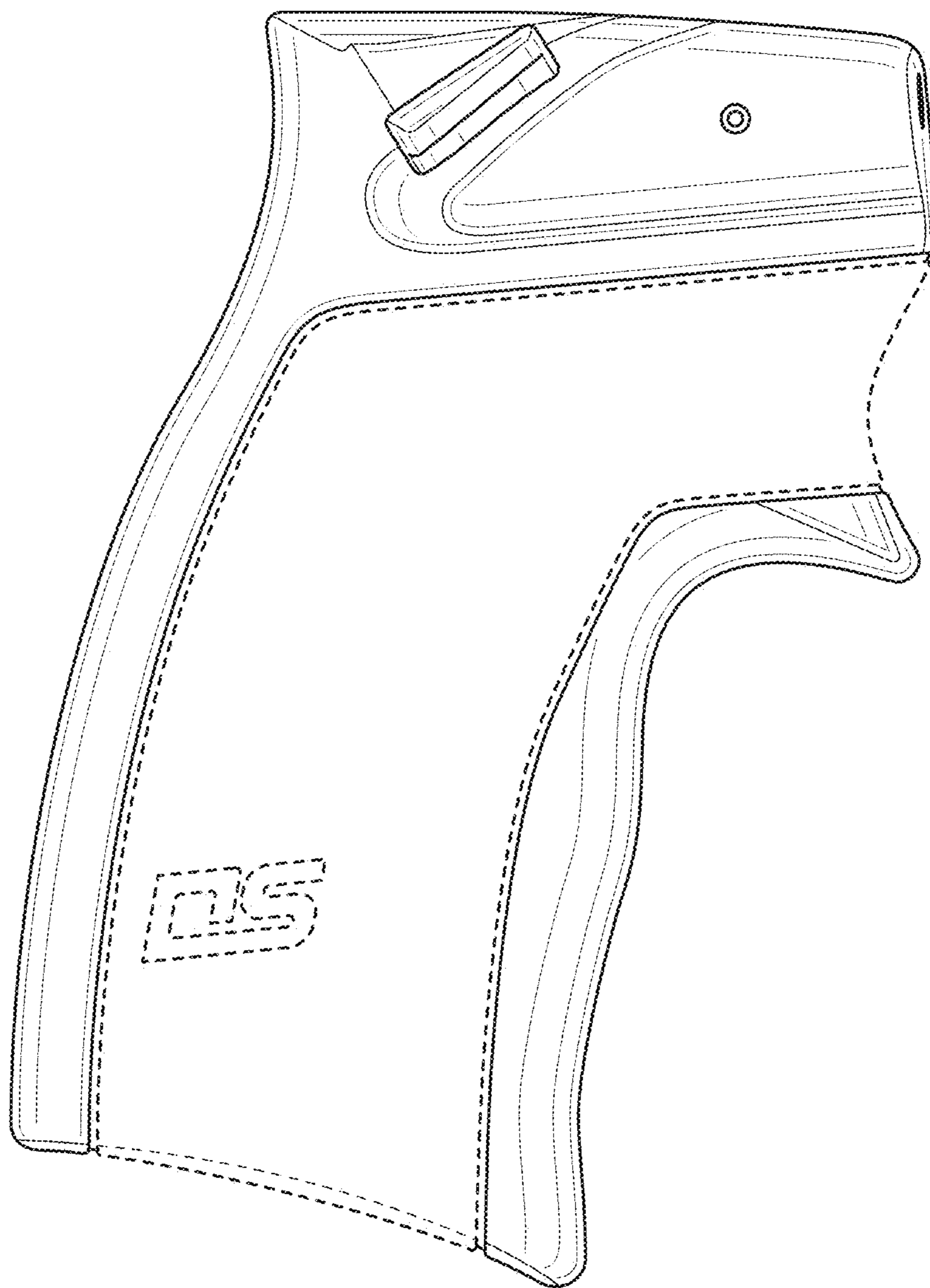

FIG. 4

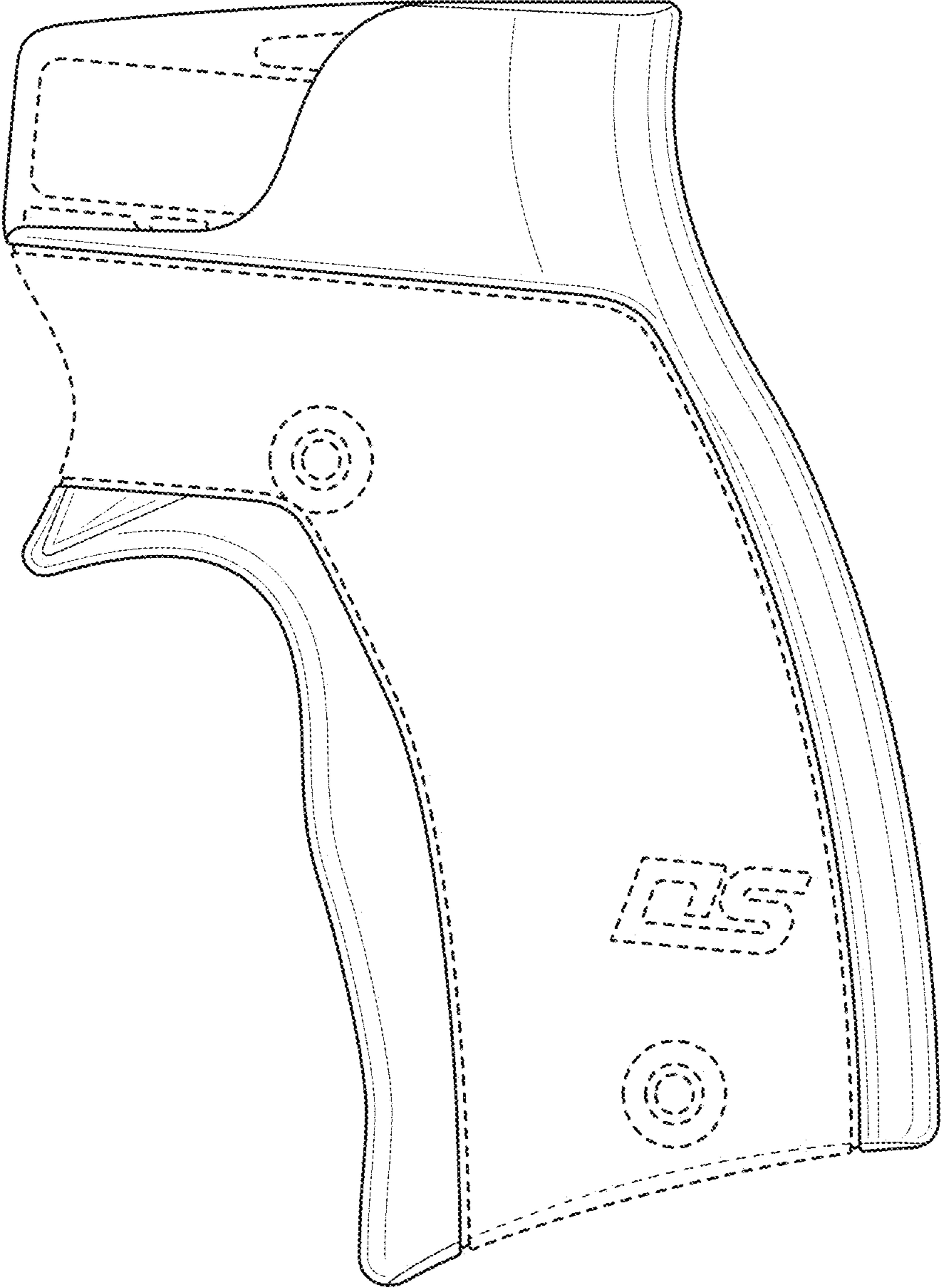

FIG. 5

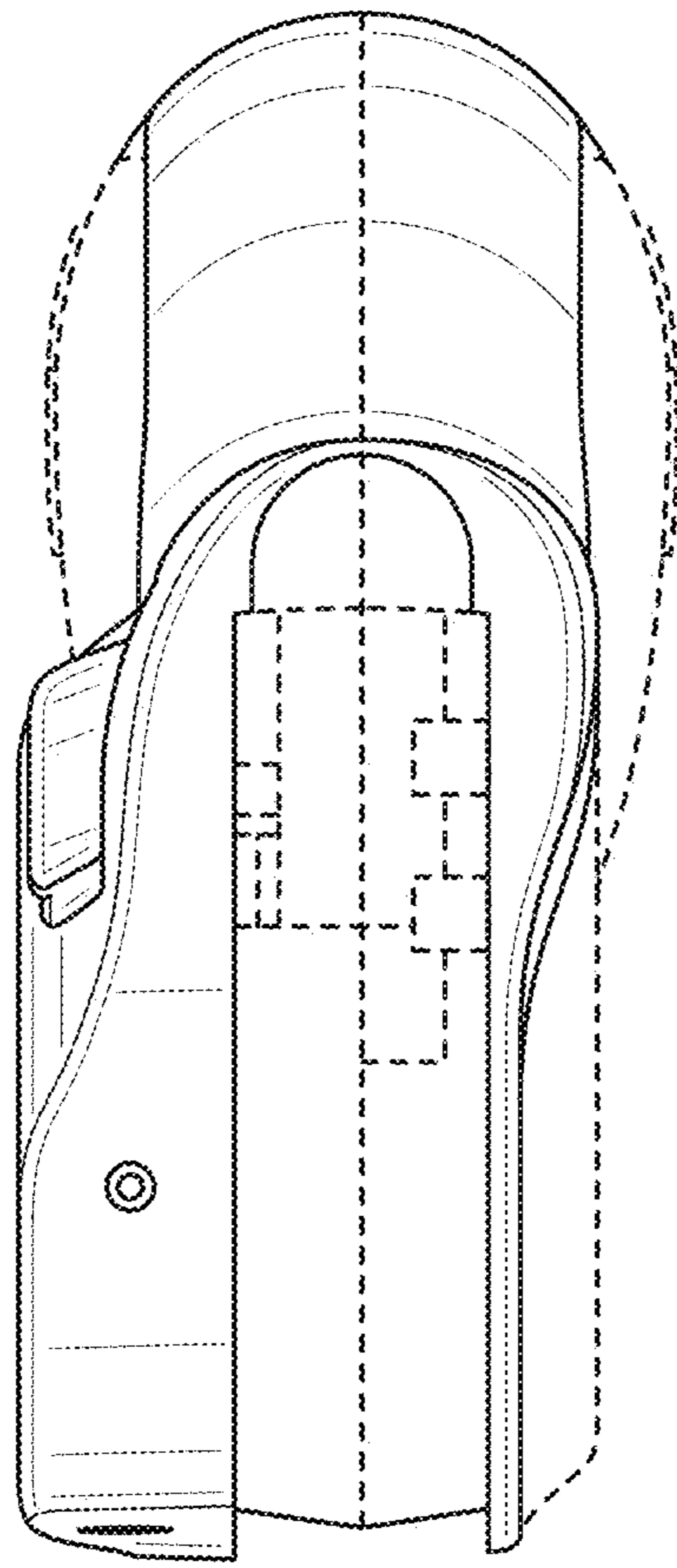

FIG. 6

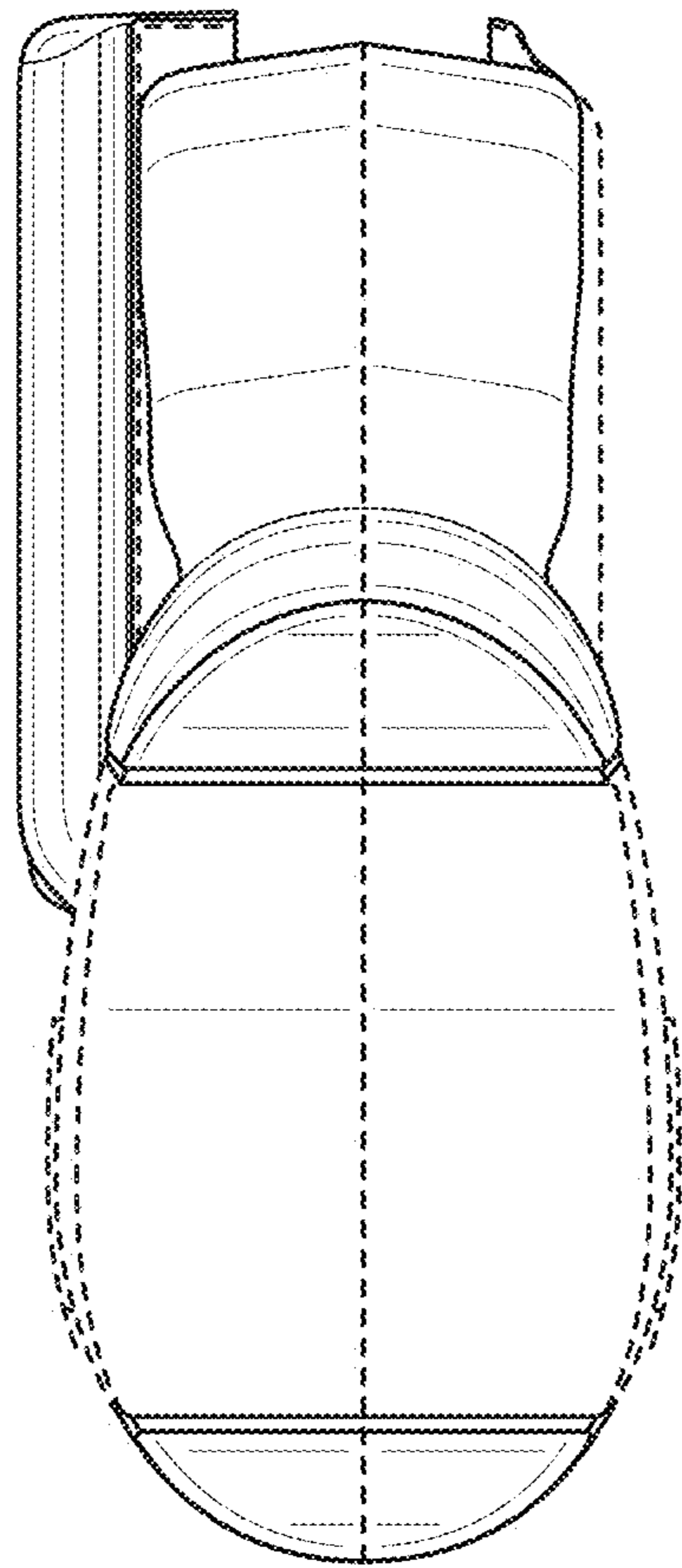

FIG. 7



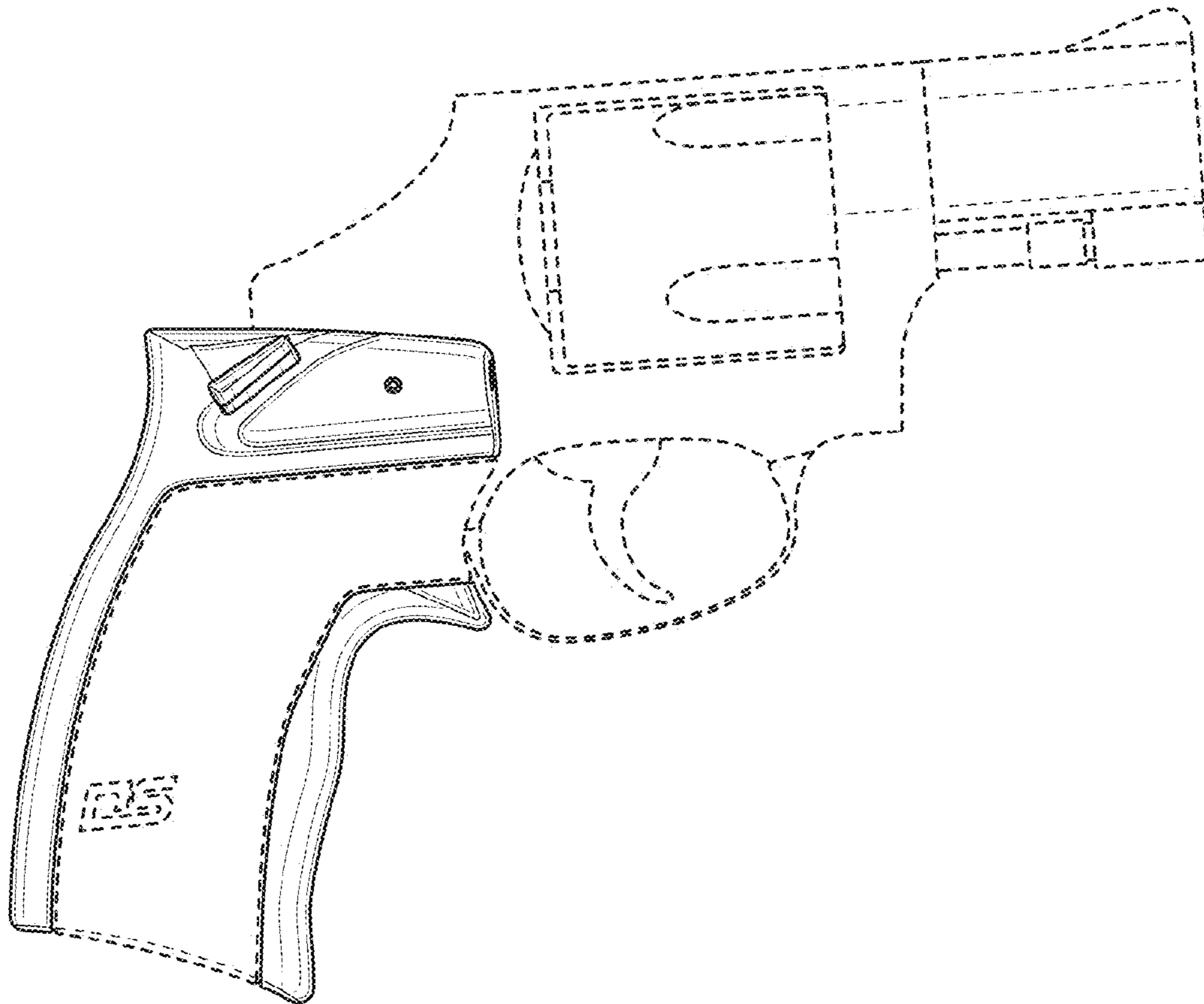

FIG. 8