



US00D709552S

(12) **United States Design Patent**
Bowman et al.

(10) **Patent No.:** **US D709,552 S**
(45) **Date of Patent:** **** Jul. 22, 2014**

- (54) **FILE FOLDER ASSEMBLY AND FOLDERS FOR USE THEREIN**
- (75) Inventors: **Vincent H. Bowman**, Highland Park, IL (US); **Jeffrey Herz**, Aliso Viejo, CA (US); **Jay K. Sato**, Mission Viejo, CA (US)
- (73) Assignee: **CCL Label, Inc.**, Framingham, MA (US)
- (**) Term: **14 Years**
- (21) Appl. No.: **29/408,728**
- (22) Filed: **Dec. 15, 2011**

Related U.S. Application Data

- (63) Continuation-in-part of application No. 29/402,327, filed on Sep. 22, 2011.
 - (51) **LOC (10) Cl.** **19-04**
 - (52) **U.S. Cl.**
USPC **D19/26**
 - (58) **Field of Classification Search**
USPC D19/26-33, 75, 86, 90; 229/67.1-67.4, 229/72; 206/214, 232, 308.1, 308.3, 425, 206/758; 40/124.2, 391; 402/3-4, 73, 79; 249/451; 383/39
- See application file for complete search history.

(56) **References Cited**

U.S. PATENT DOCUMENTS

259,410	A *	6/1882	Marmaduke	383/39
916,206	A *	3/1909	Shedd	229/67.3
1,596,661	A	8/1926	Hutchings		
1,721,248	A	7/1929	Davis		
1,929,615	A	10/1933	Tanner		
2,524,965	A	10/1950	Eddy		
3,121,966	A *	2/1964	Upton	40/124.2
3,294,134	A *	12/1966	Matross et al.	383/39
3,444,635	A *	5/1969	Setzler	40/641
3,507,064	A *	4/1970	Hammero	40/124.2
3,676,942	A *	7/1972	Elrod	40/124.2
3,863,371	A *	2/1975	Shertenlieb	40/124.2
4,085,534	A *	4/1978	Eckstein et al.	40/124.2
D252,334	S *	7/1979	Small	D19/90
4,365,433	A *	12/1982	Buell	40/391
4,444,314	A	4/1984	Jacobson		

4,588,094	A	5/1986	Evans		
4,589,544	A	5/1986	Schweinsberg		
4,706,396	A *	11/1987	Nomura	40/124.2
4,790,474	A *	12/1988	Mitsuyama	229/67.3
4,871,066	A	10/1989	La Wall		
4,921,027	A	5/1990	Scheunemann		
4,988,038	A *	1/1991	Mitsuyama	229/67.3
5,161,682	A *	11/1992	Seifert et al.	206/308.1
D334,588	S *	4/1993	Okola	D19/27
5,344,030	A	9/1994	Evenson		
5,411,135	A *	5/1995	Danzyger et al.	206/758
D359,310	S *	6/1995	Su	D19/90
5,487,617	A *	1/1996	Cole et al.	402/4
5,509,533	A *	4/1996	Veenstra	206/425
5,575,396	A	11/1996	Smed		
5,641,074	A	6/1997	Smed		
D390,871	S *	2/1998	Whitney	D19/26
5,741,028	A	4/1998	Hatano et al.		
6,030,121	A *	2/2000	Strzyinski et al.	383/39
6,065,616	A	5/2000	Velles		
D452,976	S	1/2002	Carpenter		
6,659,336	B2	12/2003	Brennan		
6,678,974	B1 *	1/2004	Su	40/124.2
6,758,336	B2	7/2004	Kohana		
6,837,368	B1 *	1/2005	Chang	206/232
6,997,310	B1 *	2/2006	Fenley	206/214
7,047,677	B2 *	5/2006	Rambaldi	40/124.2
7,152,351	B2 *	12/2006	Eby et al.	40/124.2
7,597,192	B2 *	10/2009	Lee	206/425
7,708,141	B1 *	5/2010	Huang	206/425
D662,132	S *	6/2012	Smith et al.	D19/26
8,245,423	B2 *	8/2012	Goslee	40/388
8,540,138	B1 *	9/2013	Christensen et al.	229/67.3
D699,300	S *	2/2014	Lyons	D19/90
2006/0226204	A1	10/2006	O'Leary et al.		
2007/0012752	A1	1/2007	Lee		
2007/0235506	A1	10/2007	Shapiro		
2008/0223907	A1	9/2008	Su		
2009/0166400	A1	7/2009	Lee		
2010/0258613	A1	10/2010	Goslee		
2013/0075457	A1 *	3/2013	Sato et al.	229/67.2

FOREIGN PATENT DOCUMENTS

DE	20 2005 01196	10/2005
EP	0126980	12/1984

OTHER PUBLICATIONS

- Notification of Registration for Australian Design Application 11468/2012 dated Jun. 7, 2012, 13 pgs.
- Notification of Registration for Australian Design Application 12476/2012 dated Jun. 22, 2012, 6 pgs.

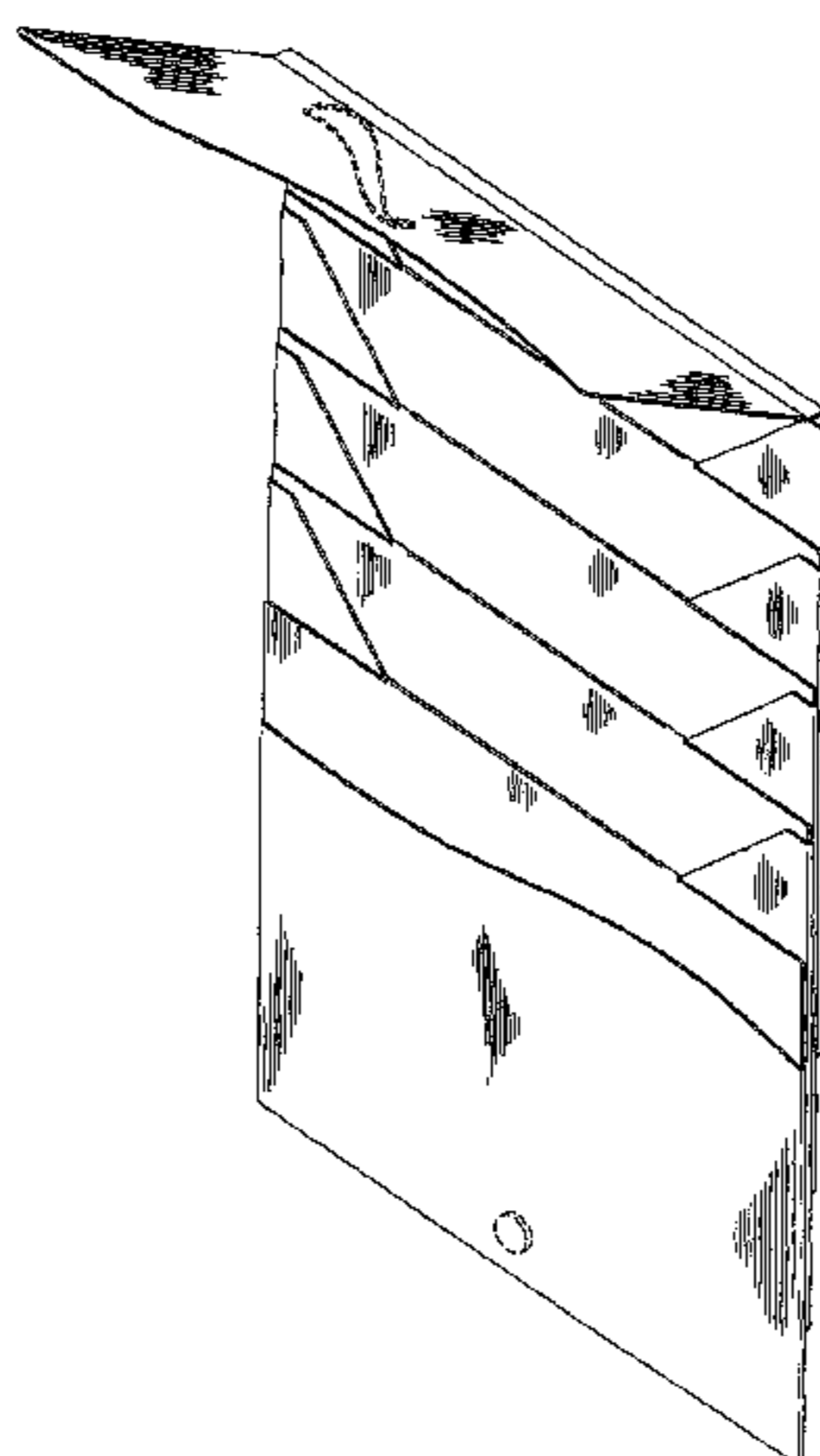

Notification of Registration for Australian Design Application 12475/2012 dated Jun. 7, 2012, 6 pgs.
 Notification of Registration for Australian Design Application 12474/2012 dated Jun. 7, 2012, 8 pgs.
 Office Action issued in Canadian Design Application No. 145,015 dated Oct. 9, 2012, 2 pgs.
 Response to Canadian OA issued in Design Application No. 145,015 dated Feb. 5, 2013, 25 pgs.
 Office Action in New Zealand Application No. 416026 dated Apr. 10, 2012, 2 pgs.
 Response to Office Action in New Zealand Application No. 416026 dated Jun. 15, 2012, 46 pgs.
 Registration Certificate in New Zealand Application No. 416026 dated Jul. 5, 2012, 12 pgs.
 Registration Certificate in New Zealand Application No. 416371 dated Jul. 5, 2012, 5 pgs.
 Registration Certificate in New Zealand Application No. 416373 dated Jul. 5, 2012, 5 pgs.
 Registration Certificate in New Zealand Application No. 416374 dated Jul. 5, 2012, 7 pgs.
 International Search Report and Written Opinion in PCT Application No. PCT/US2012/029831 dated Jun. 19, 2012, 13 pgs.
 Notice of Allowance in Design U.S. Appl. No. 29/402,327 dated Nov. 15, 2012, 14 pgs.
 Eldon Rubbermaid Add on Pocket for Hot Wall File, Smoke; http://www.staples.com/Eldon-Rubbermaid-Add-on-Pocket-for-Hot-Wall-File-Smoke/product_114173 dated May 8, 2012, 1 pg.
 Folder with Four Sliding Pockets, Ltr., 100 Sht. Cap., Blue; http://www.amazon.com/Folder-Sliding-Pockets_Ltr-Blue/dp/B006L0PMRK/ref=sr_1_3?s=office-products&ie=UTF8&qid=1328292318&sr=1-3 dated May 8, 2012, 1 pg.
 Office Action Issued in Argentina Design Application 83689, dated Jun. 28, 2012, 2 pgs. (English Translation).

* cited by examiner

Primary Examiner — T. Chase Nelson
Assistant Examiner — Kathleen M Sims
 (74) *Attorney, Agent, or Firm* — McDonald Hopkins LLC

(57) **CLAIM**

We claim the ornamental design for a file folder assembly and folders for use therein, as shown and described.

DESCRIPTION

FIG. 1 is a front perspective view of a file folder assembly and folders for use therein showing our new design in an expanded state with the back folder cover flap partially opened;

FIG. 2 is a front elevational view thereof;
 FIG. 3 is a right side elevational view thereof;
 FIG. 4 is a left side elevational view thereof;
 FIG. 5 is a rear elevational view thereof;
 FIG. 6 is a top plan view thereof;
 FIG. 7 is a bottom plan view thereof;
 FIG. 8 is a front perspective view of the file folder assembly and folders for use therein shown in a compacted state with the back folder cover flap partially opened;
 FIG. 9 is a front elevational view thereof;
 FIG. 10 is a right side elevational view thereof;
 FIG. 11 is a left side elevational view thereof;
 FIG. 12 is a rear elevational view thereof;
 FIG. 13 is a top plan view thereof;
 FIG. 14 is a bottom plan view thereof;
 FIG. 15 is a front perspective view of the front folder of the file folder assembly and folders for use therein with the cover flap of the front folder partially opened and folded reward;
 FIG. 16 is a front elevational view thereof;
 FIG. 17 is a right side elevational view thereof;
 FIG. 18 is a left side elevational view thereof;
 FIG. 19 is a rear elevational view thereof;
 FIG. 20 is a top plan view thereof;
 FIG. 21 is a bottom plan view thereof;
 FIG. 22 is a front perspective view of one of the three identical middle folders of the file folder assembly and folders for use therein of FIG. 1 with the middle folder cover flap opened and folded reward;
 FIG. 23 is a front elevational view thereof;
 FIG. 24 is a right side elevational view thereof;
 FIG. 25 is a left side elevational view thereof;
 FIG. 26 is a rear elevational view thereof;
 FIG. 27 is a top plan view thereof;
 FIG. 28 is a bottom plan view thereof;
 FIG. 29 is a front perspective view of the back folder of the file folder assembly and folders for use therein of FIG. 1 with the back folder cover flap partially opened;
 FIG. 30 is a front elevational view thereof;
 FIG. 31 is a right side elevational view thereof;
 FIG. 32 is a left side elevational view thereof;
 FIG. 33 is a rear elevational view thereof;
 FIG. 34 is a top plan view thereof; and,
 FIG. 35 is a bottom plan view thereof.
 The dashed lines shown in the drawings represent portions of the file folder assembly and folders for use therein that do not form a part of the claimed design.

1 Claim, 21 Drawing Sheets

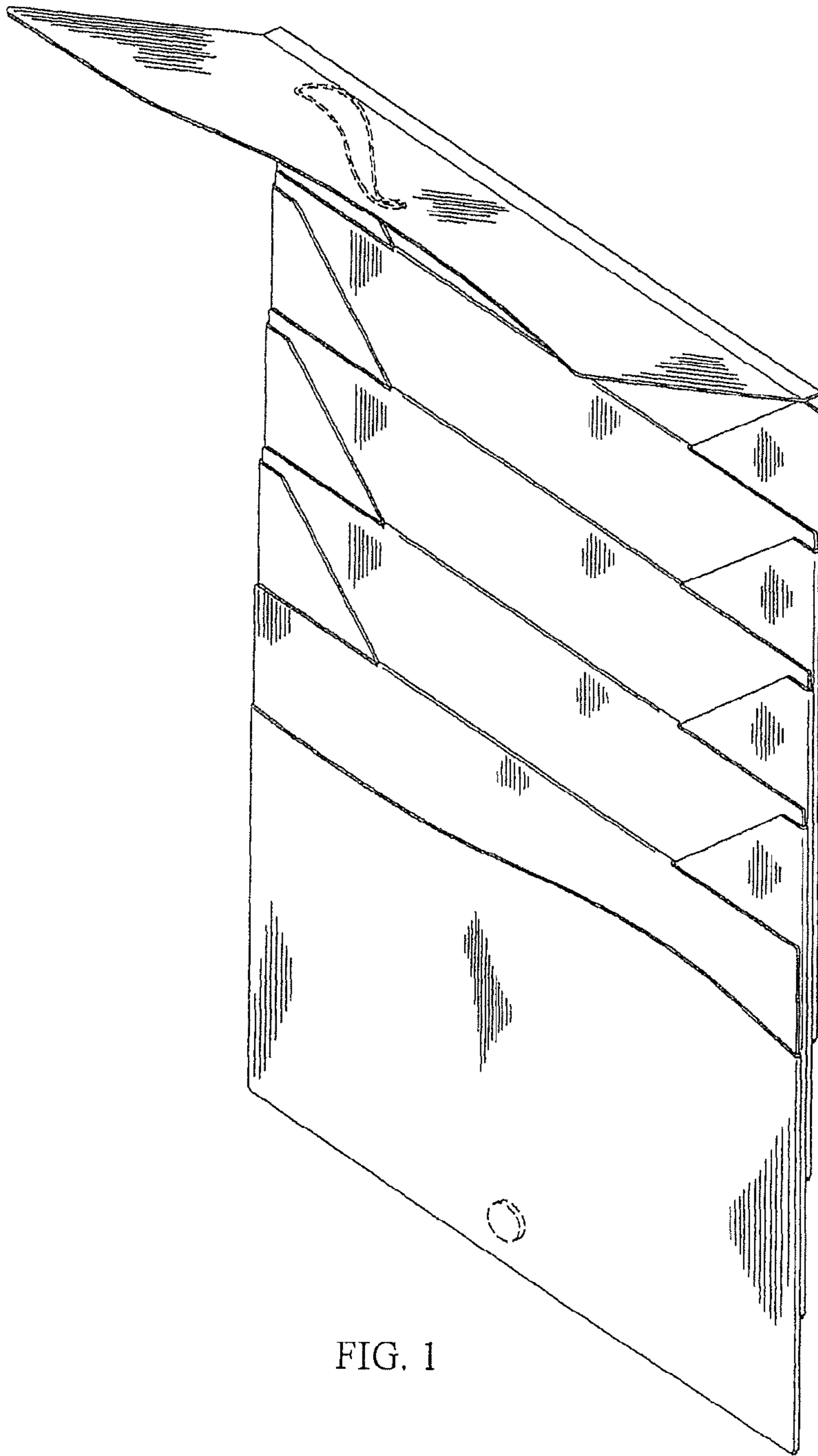

FIG. 1

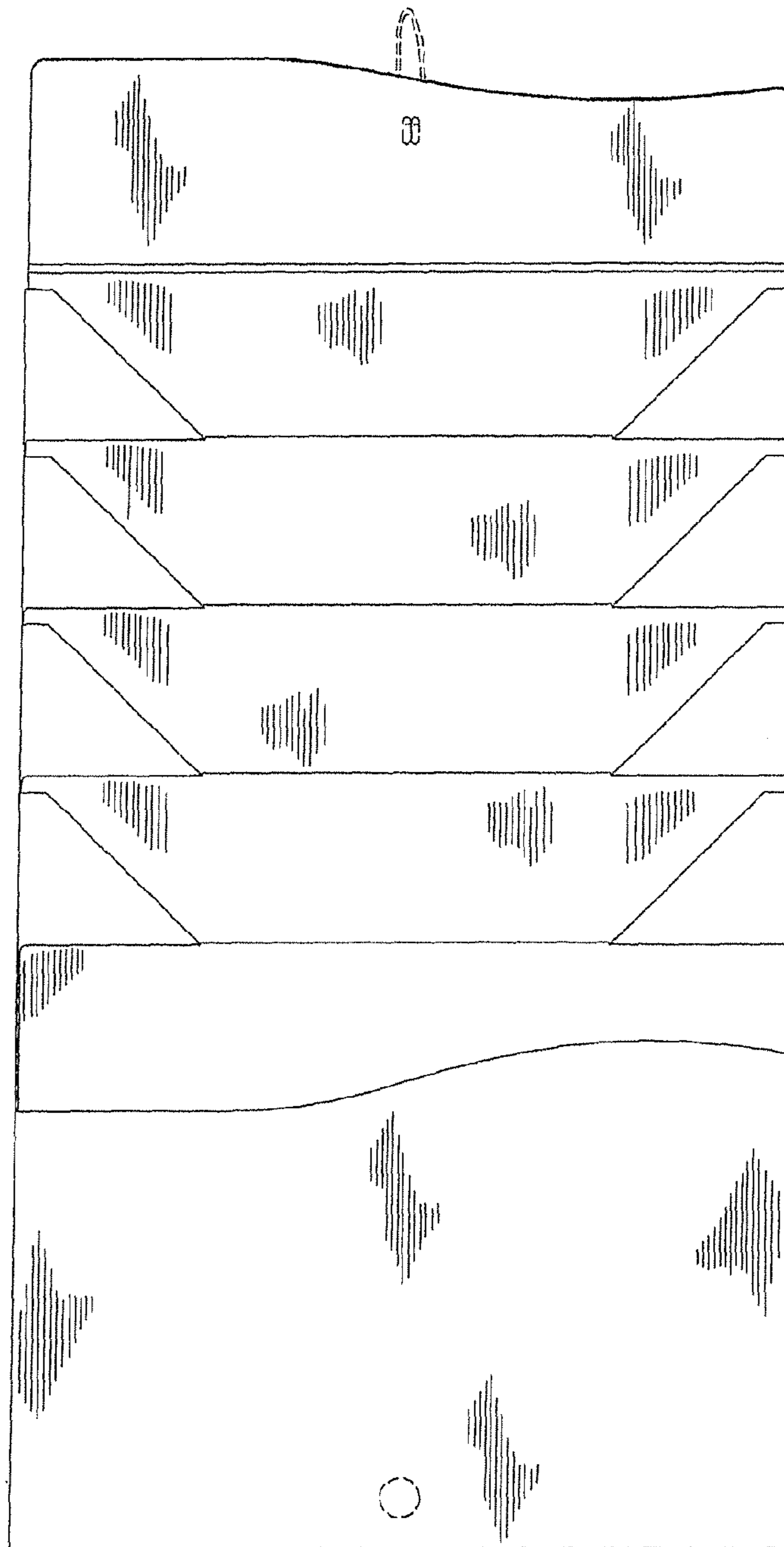

FIG. 2

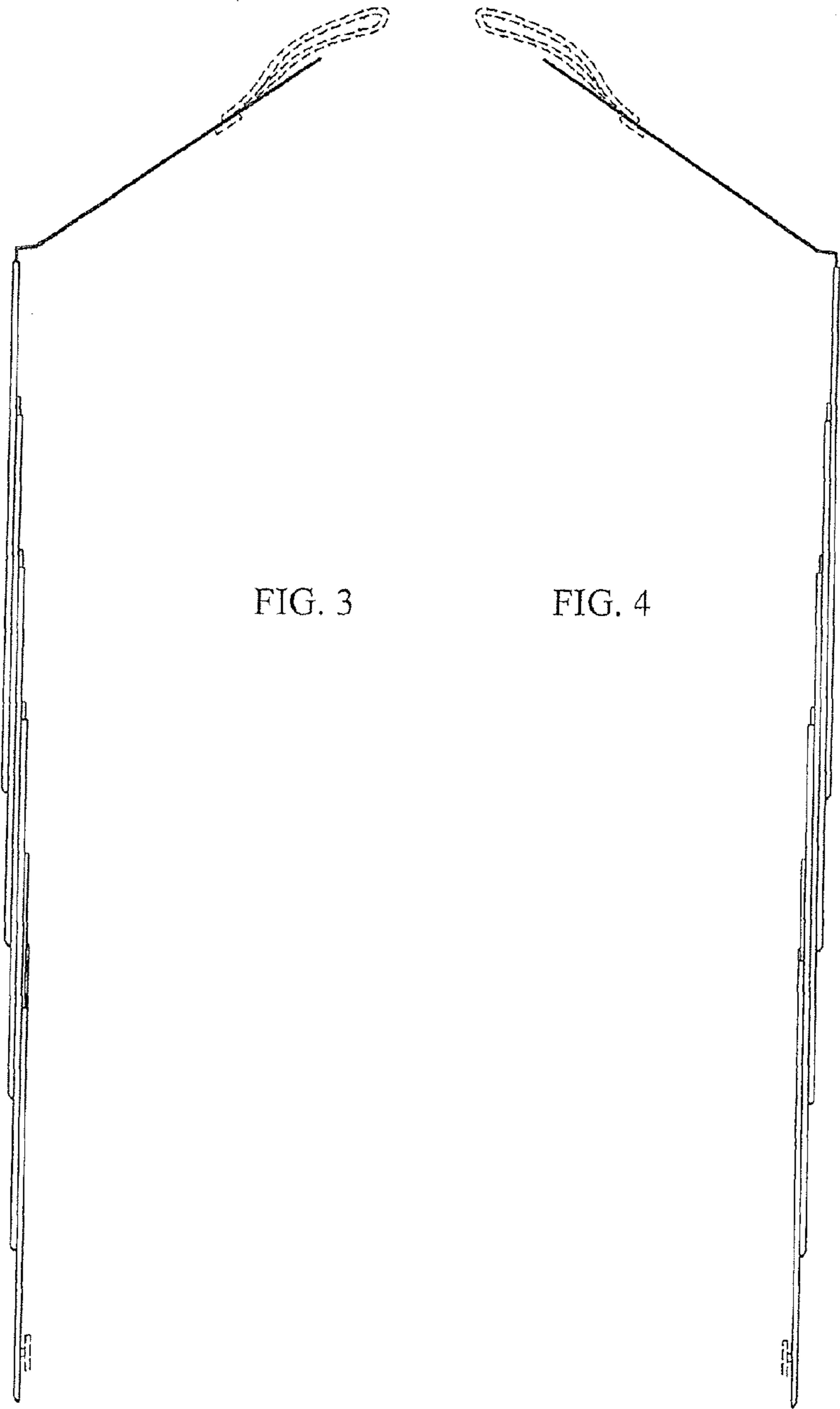
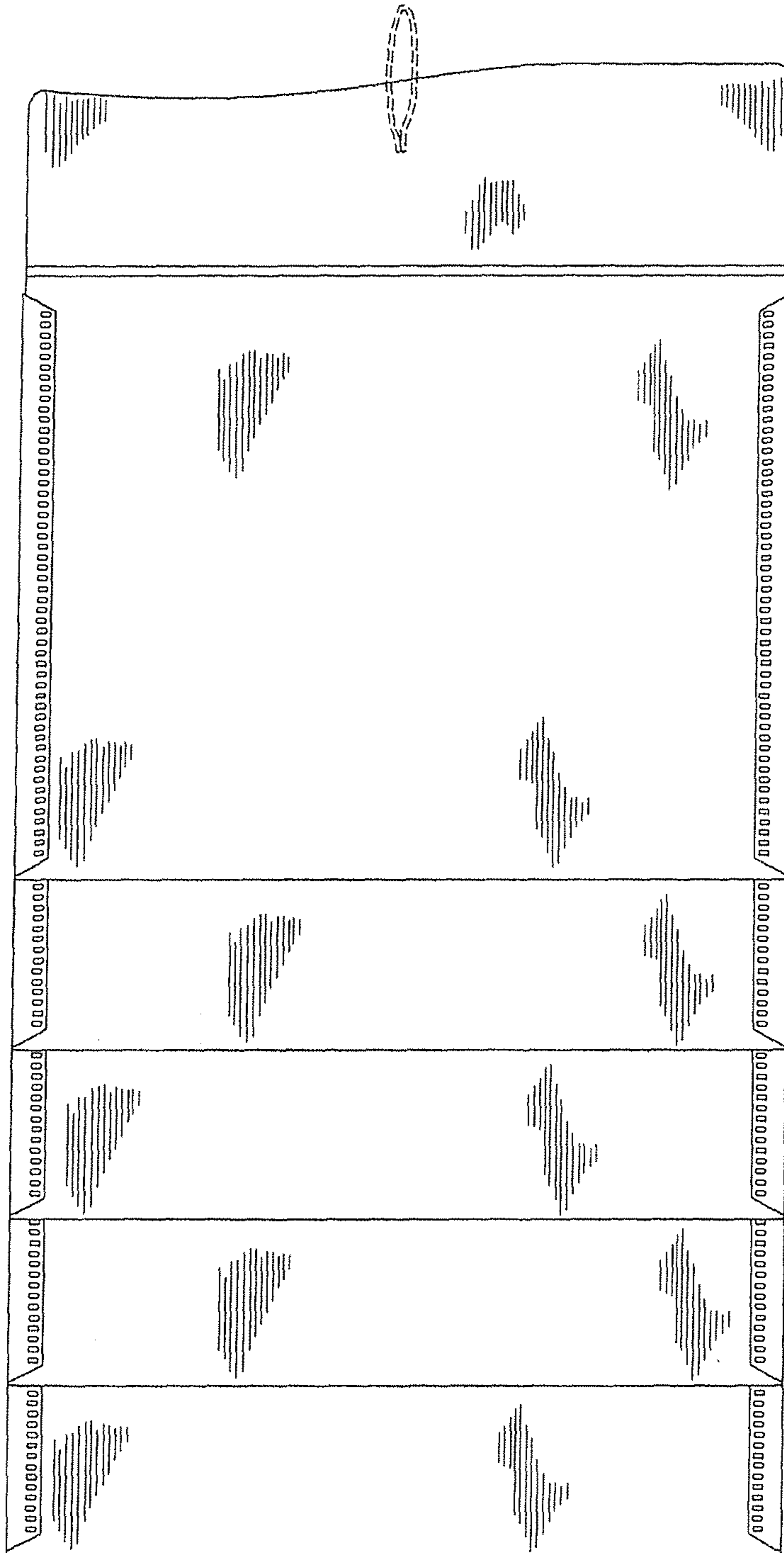

FIG. 3

FIG. 4

FIG. 5



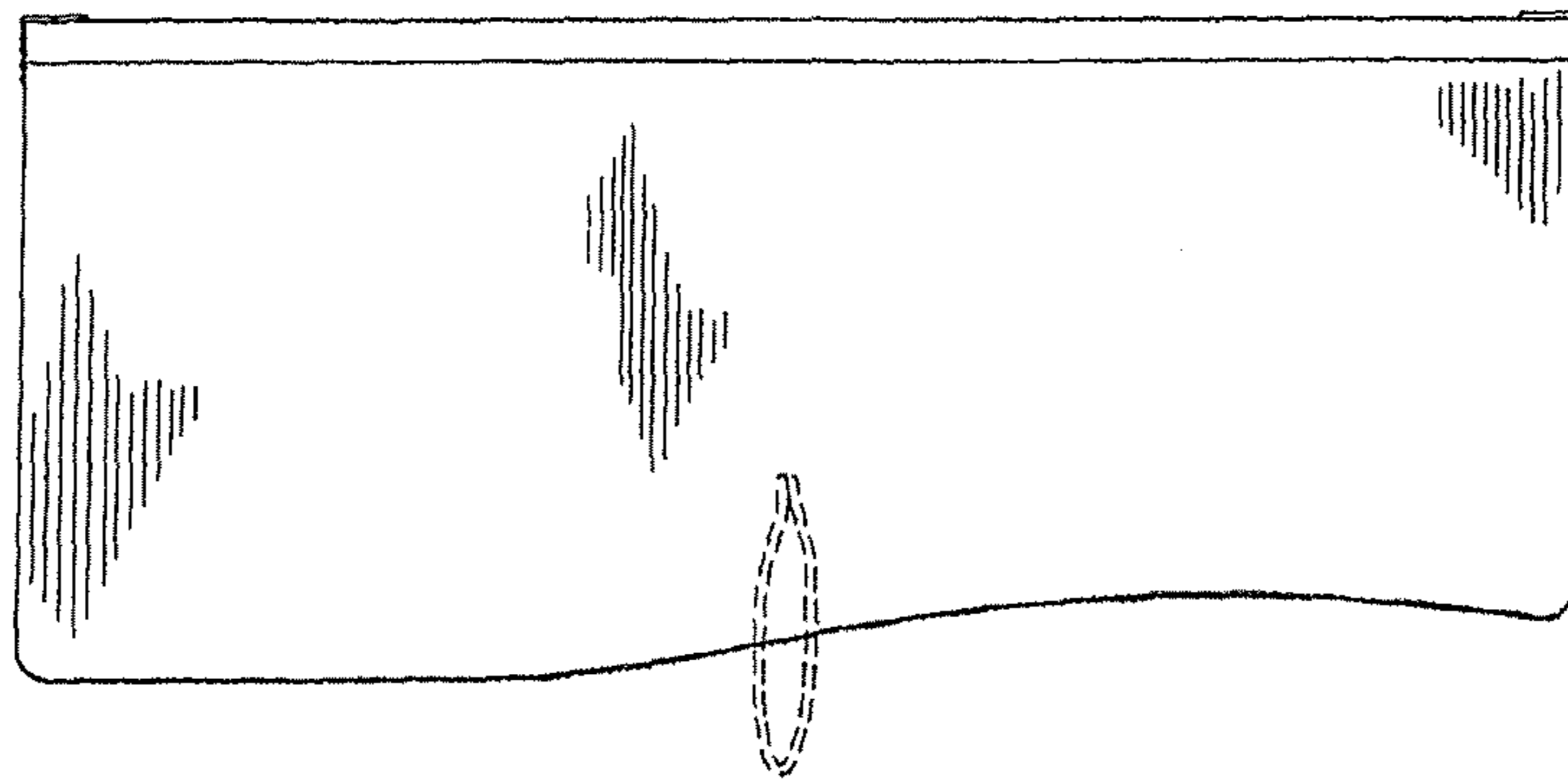

FIG. 6

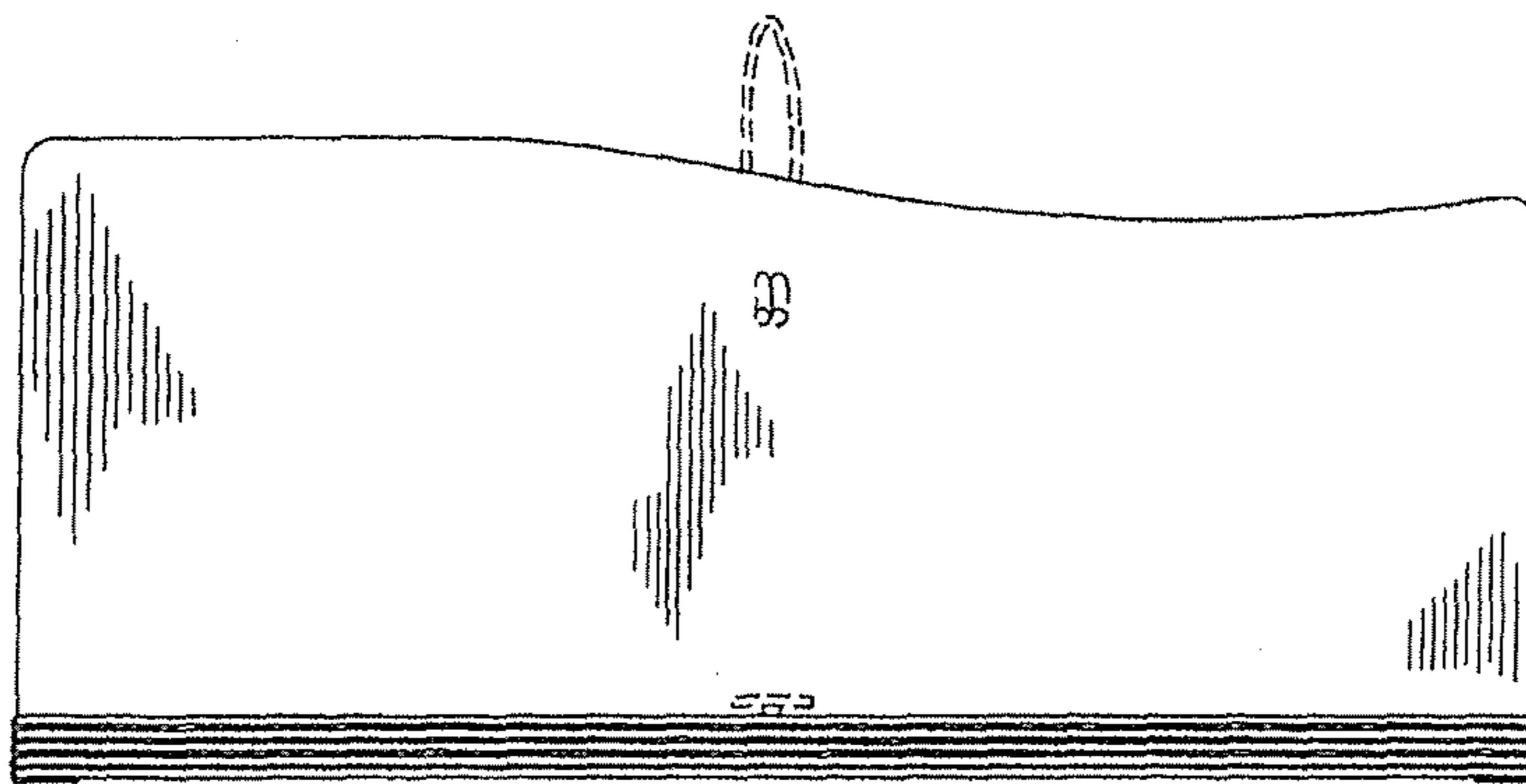

FIG. 7

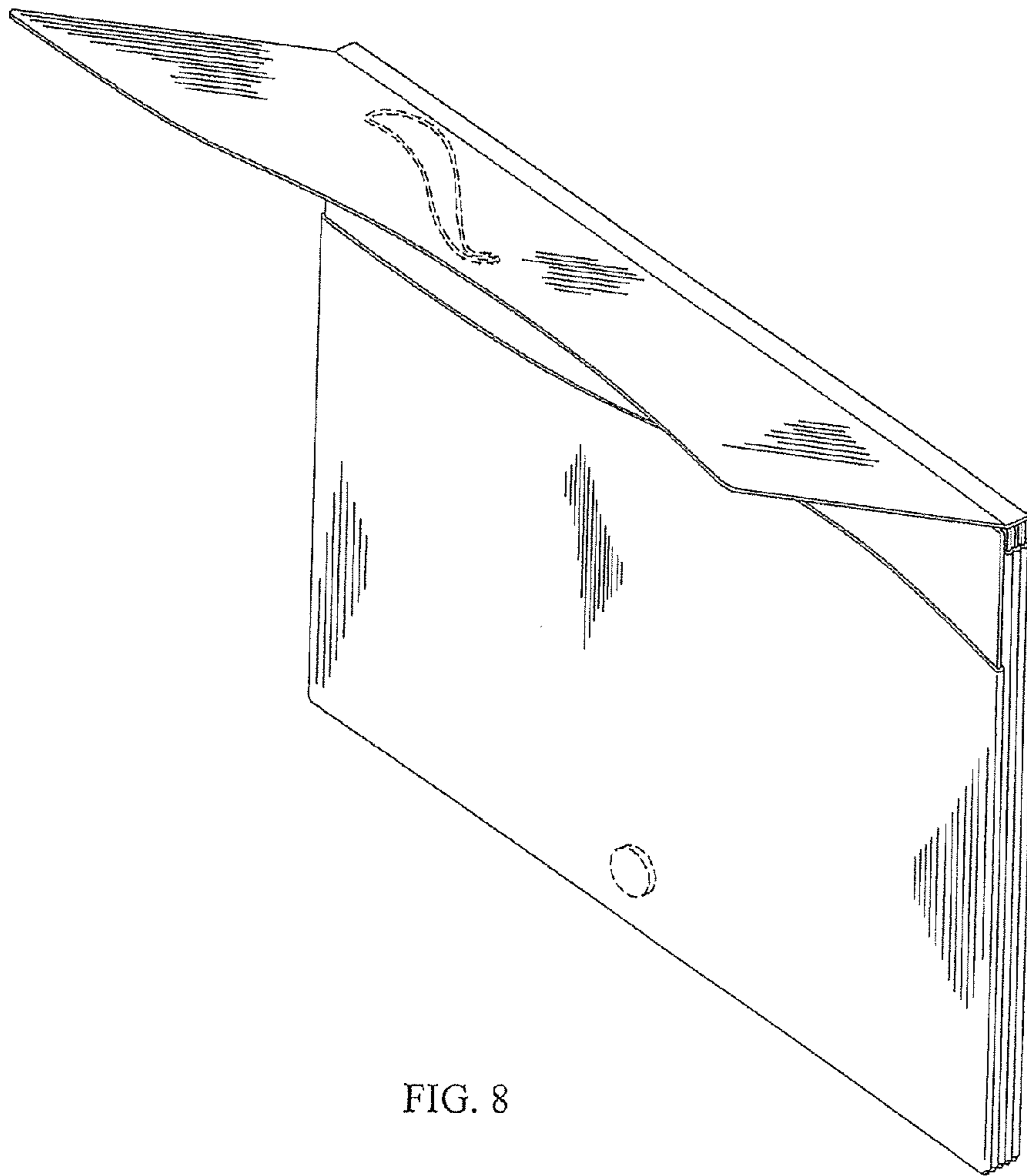

FIG. 8

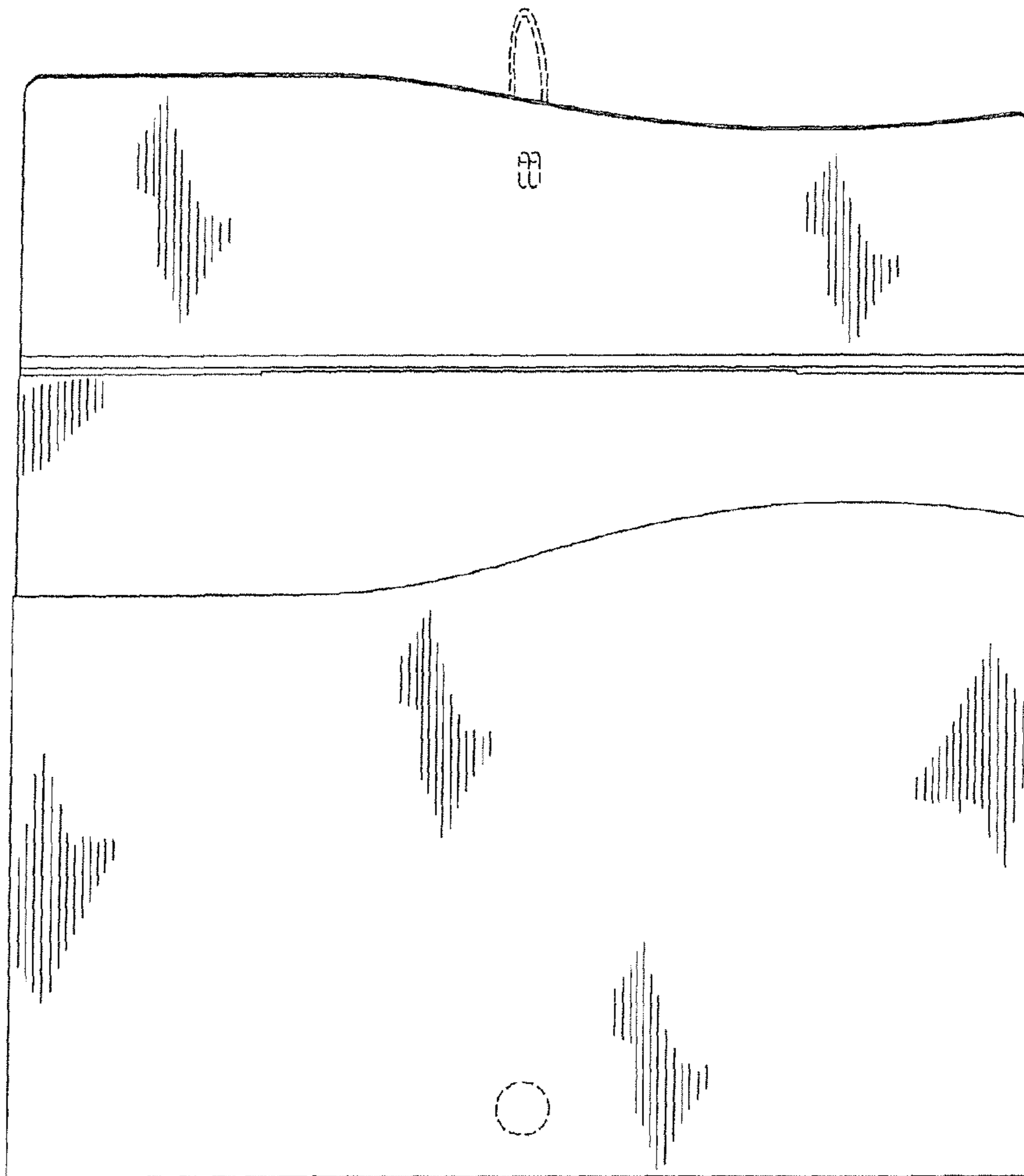
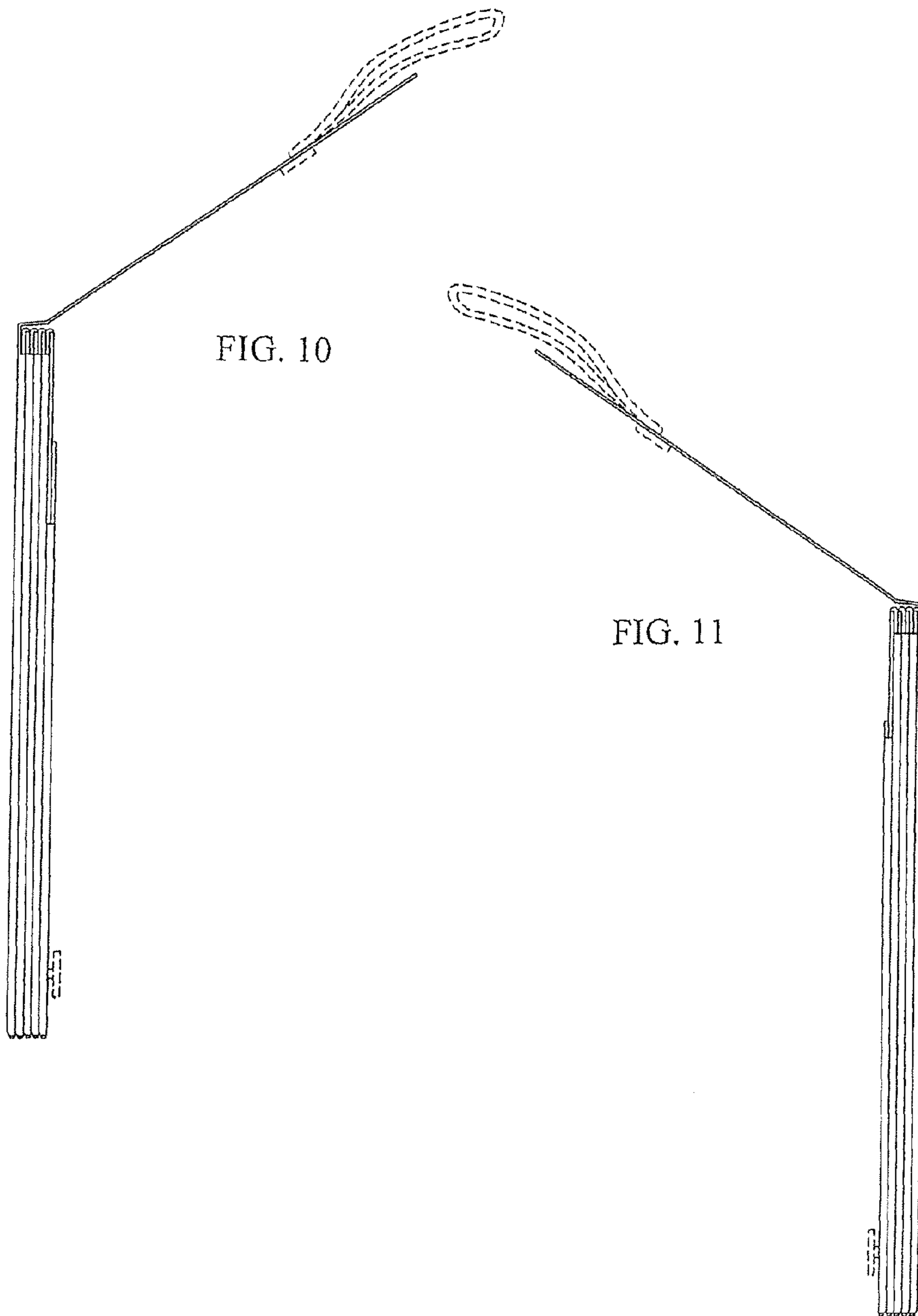

FIG. 9



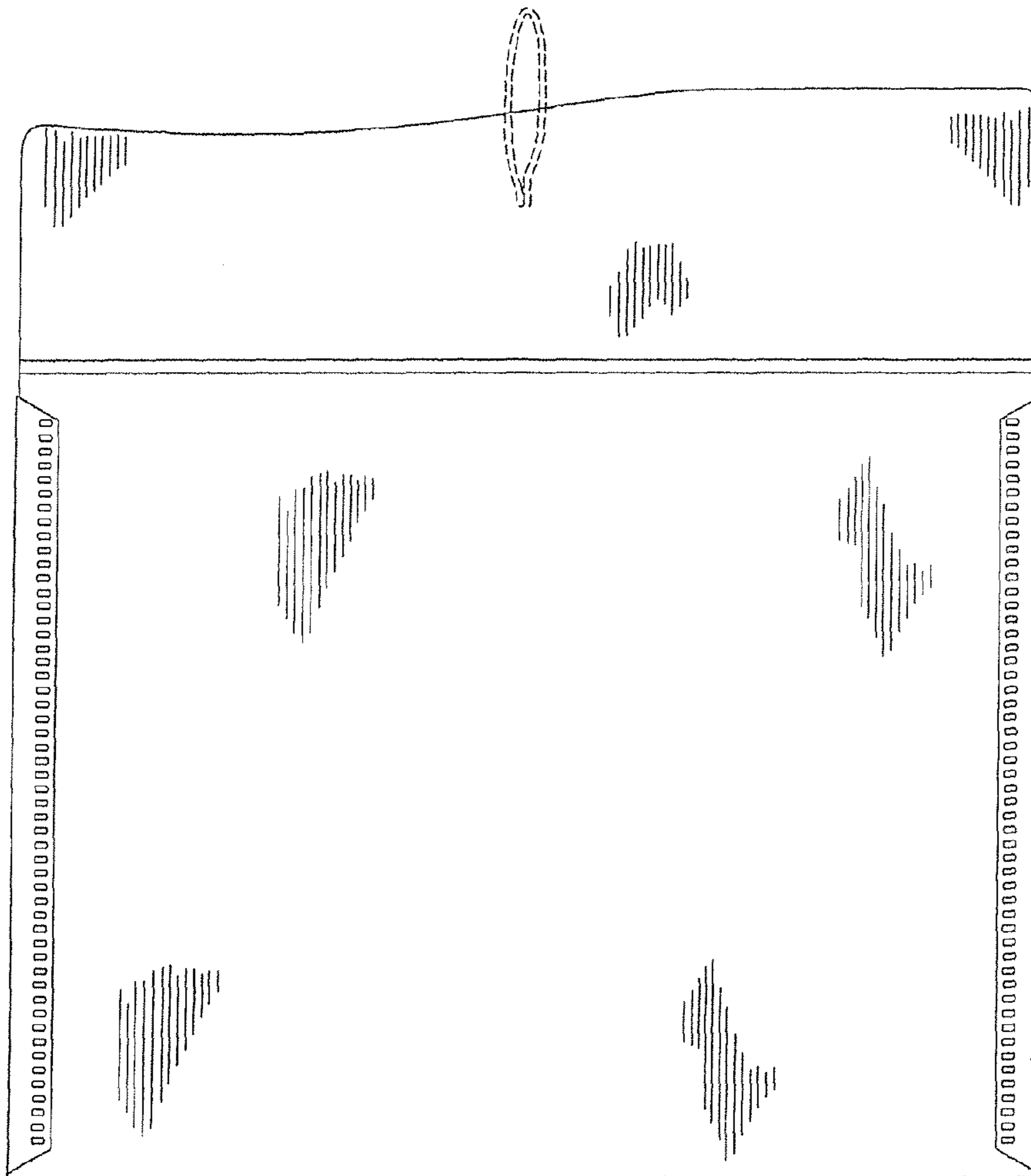

FIG. 12

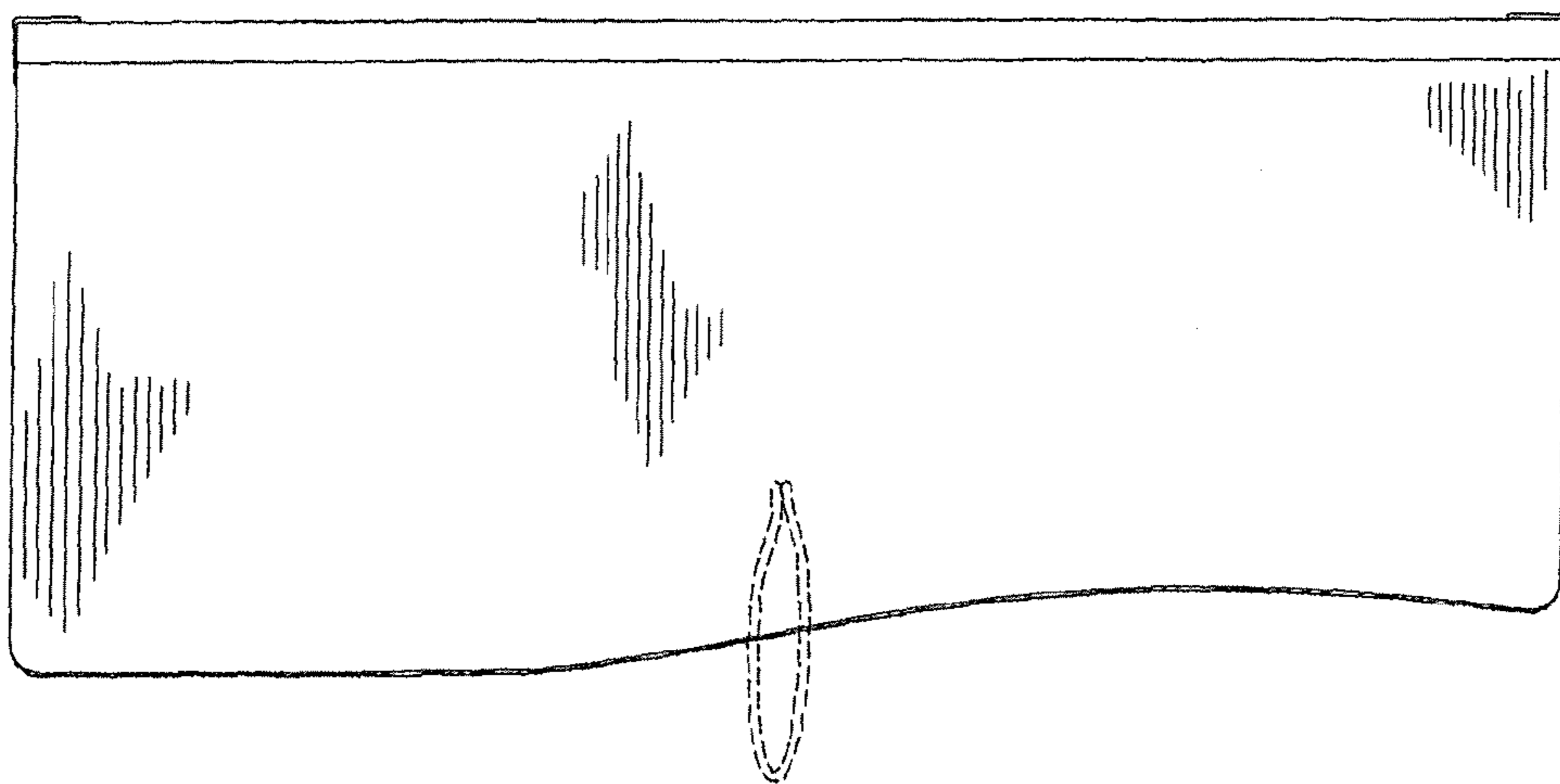

FIG. 13

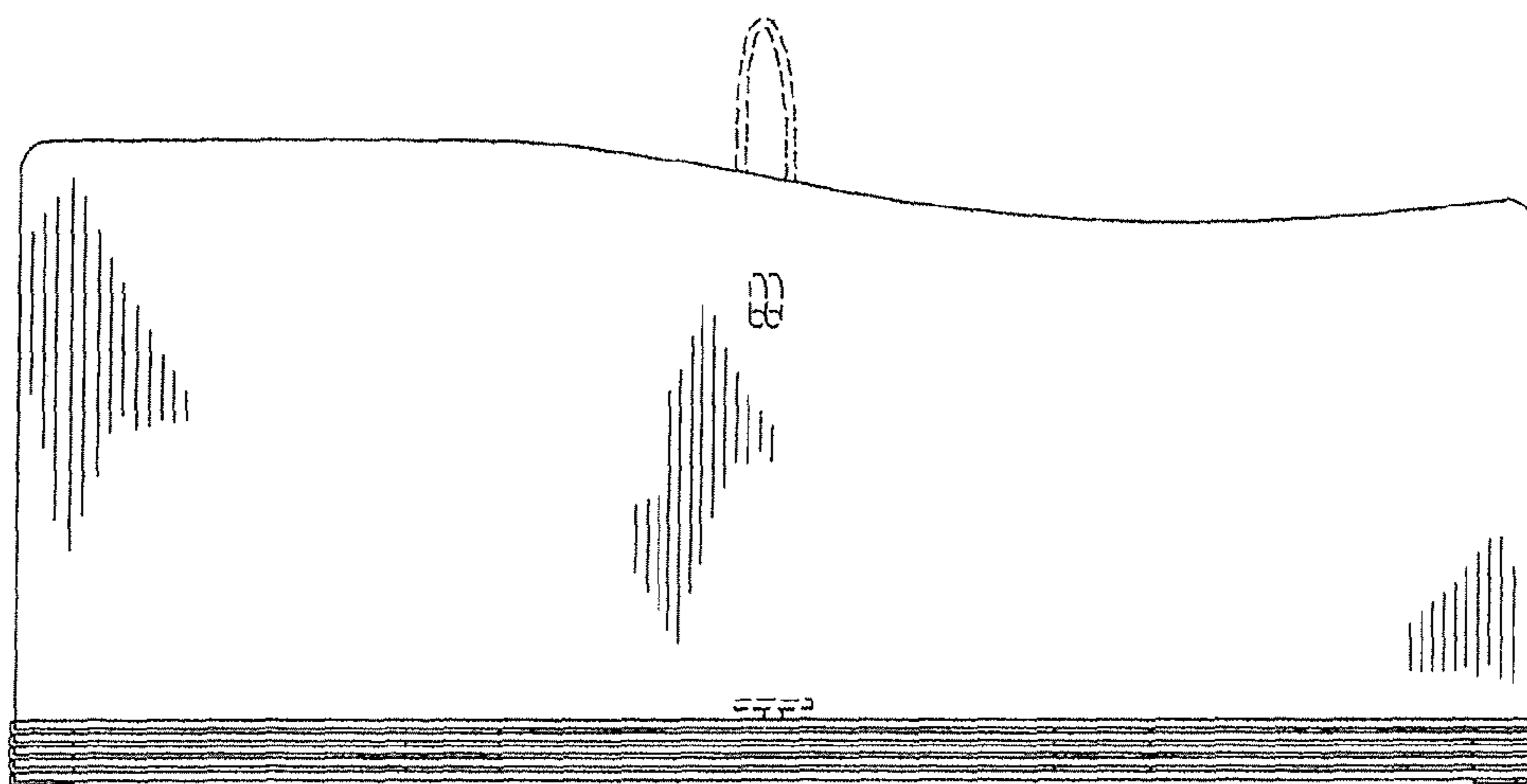

FIG. 14

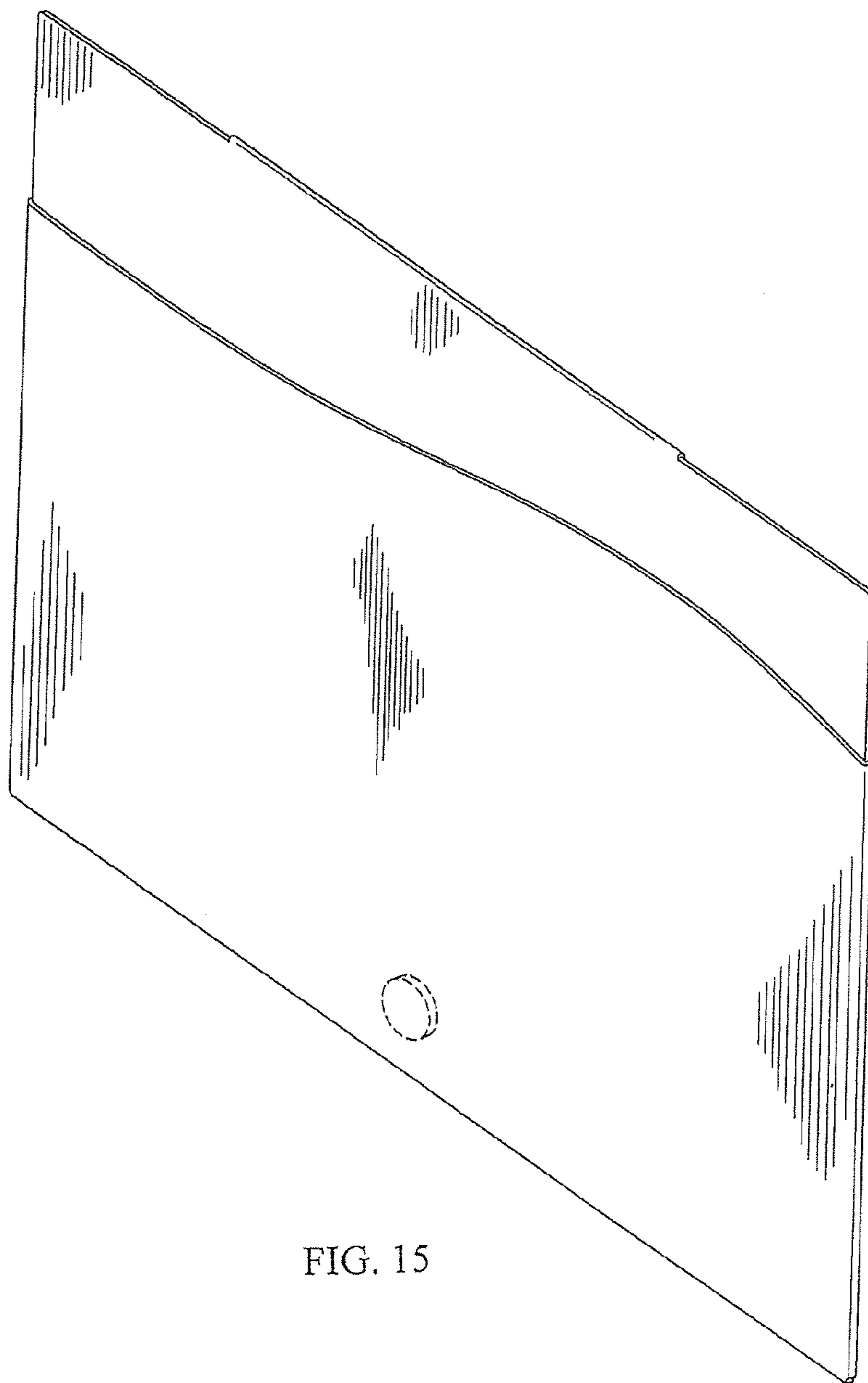

FIG. 15

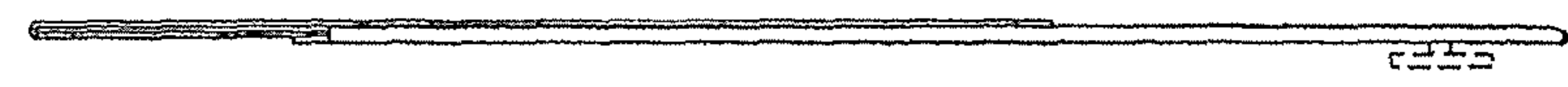

FIG. 18

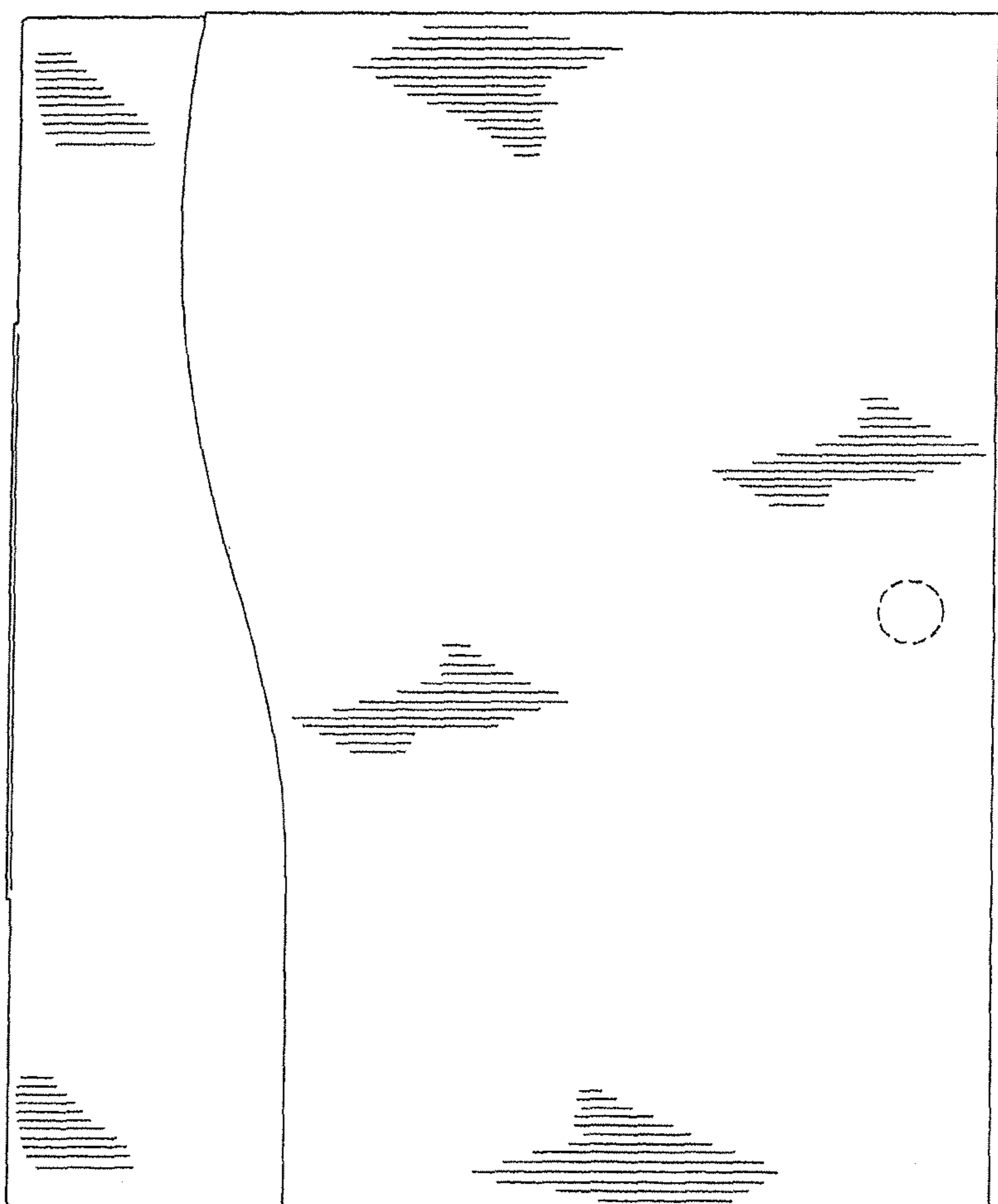

FIG. 16



FIG. 17

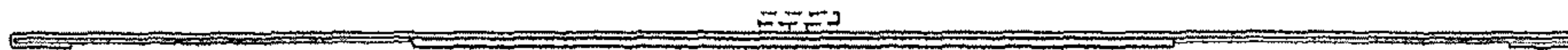

FIG. 20

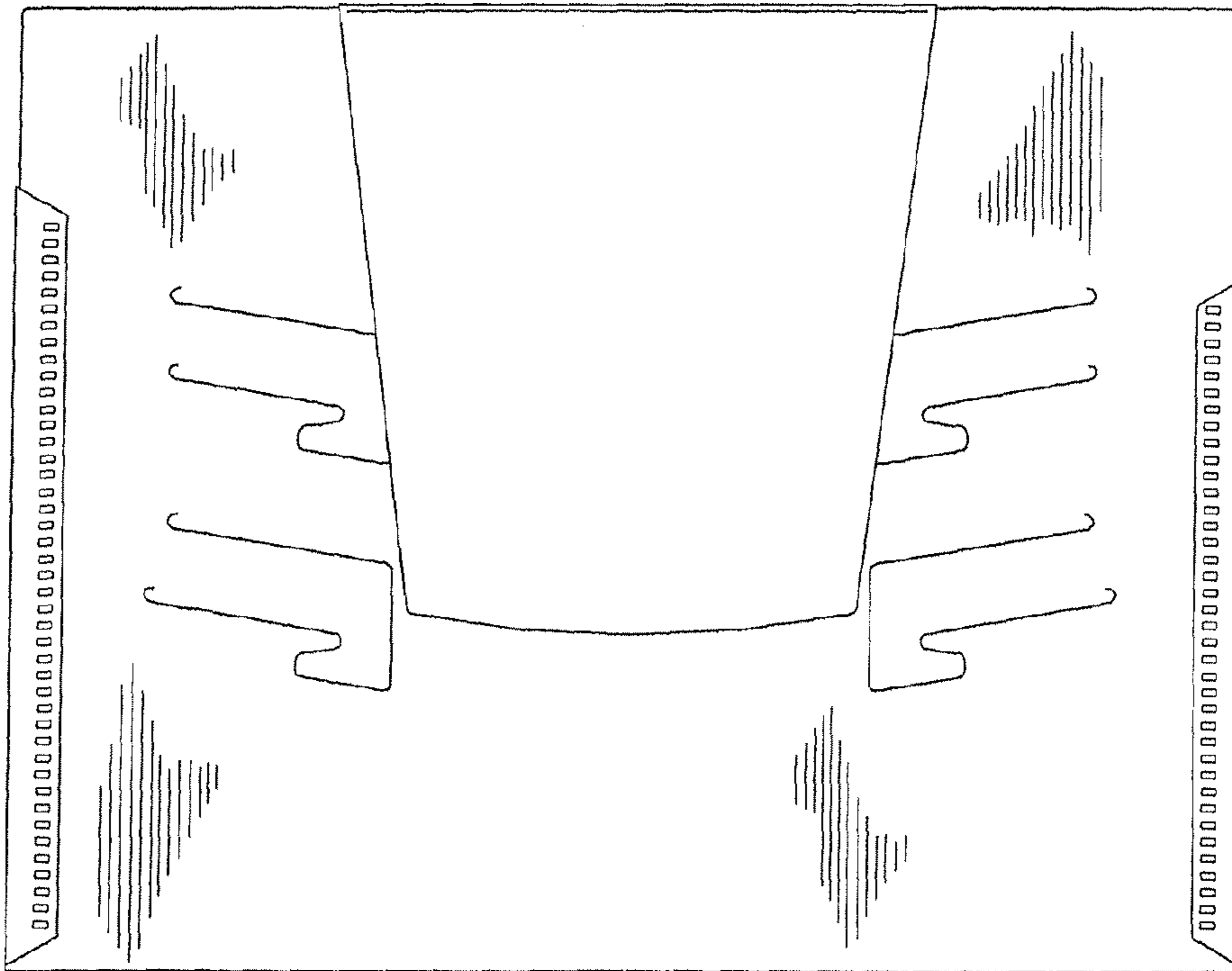

FIG. 19

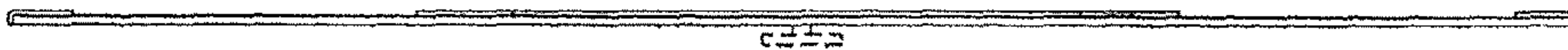

FIG. 21

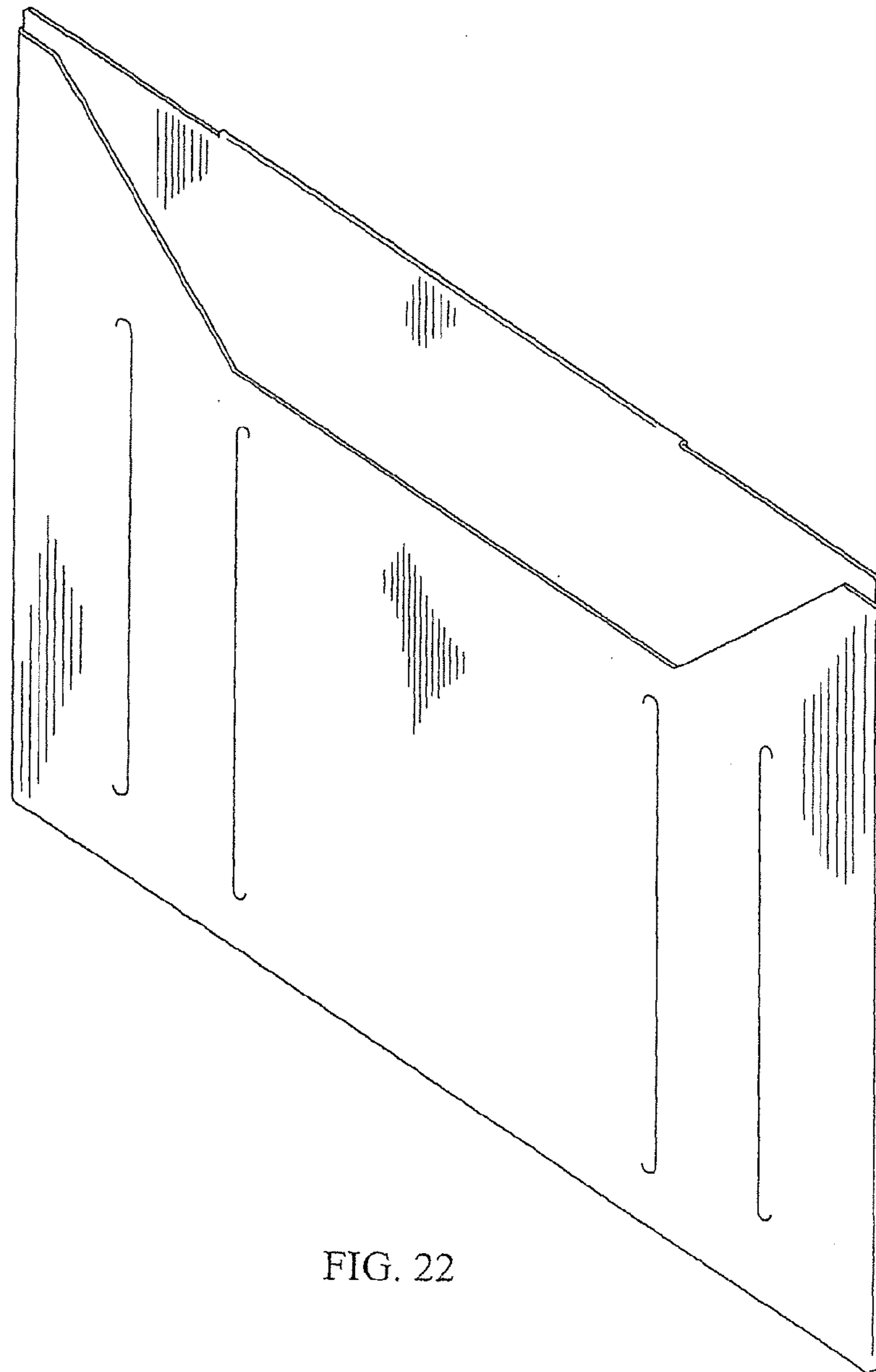

FIG. 22

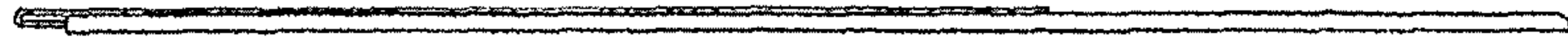

FIG. 25

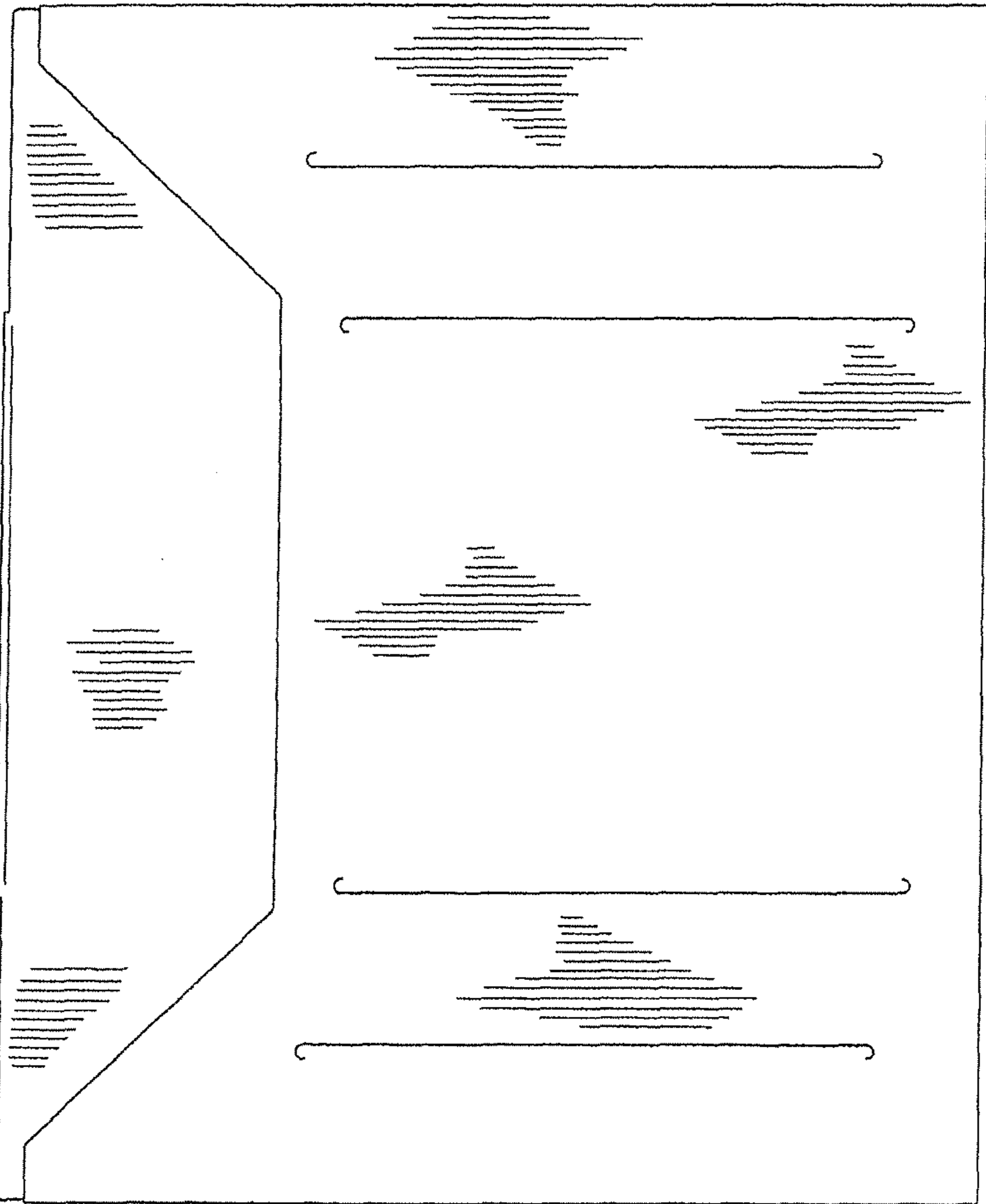

FIG. 23

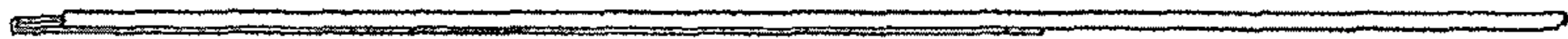

FIG. 24

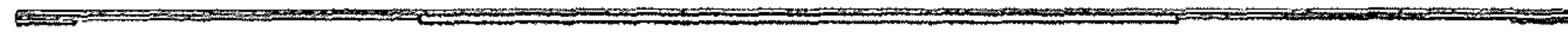

FIG. 27

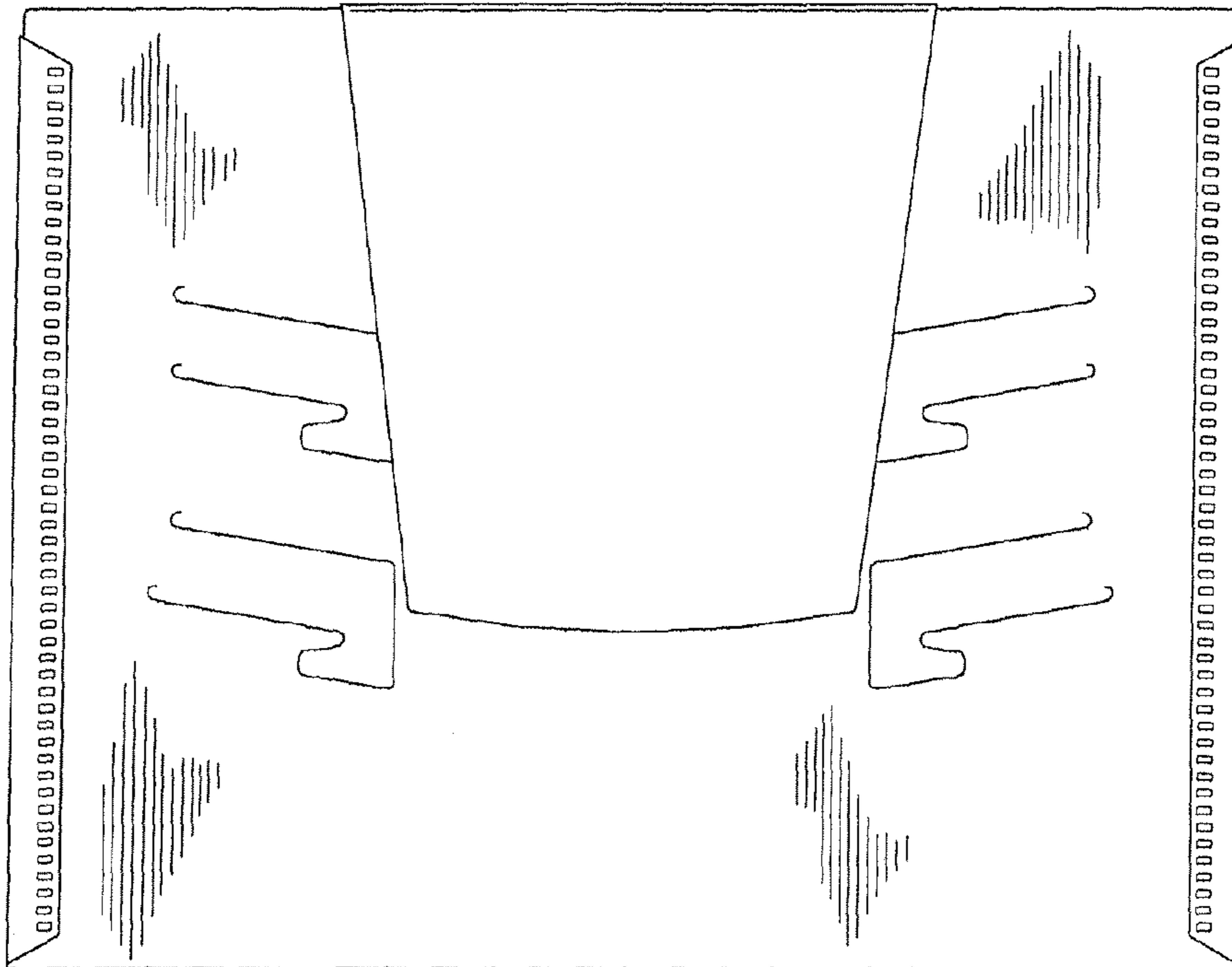

FIG. 26

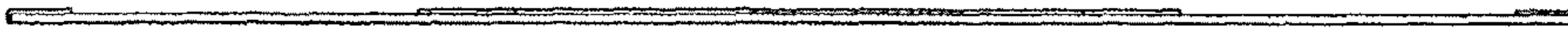

FIG. 28

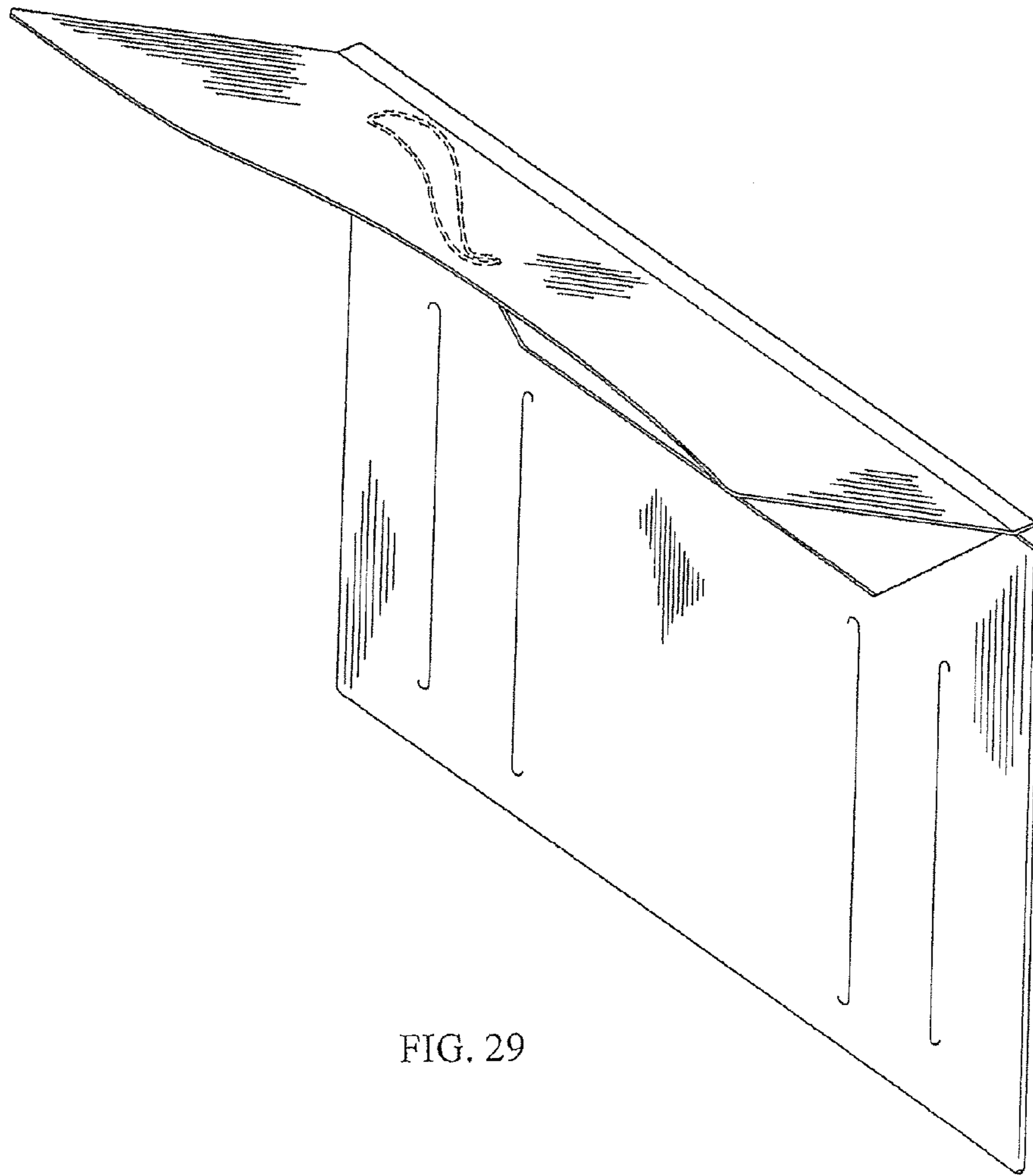

FIG. 29

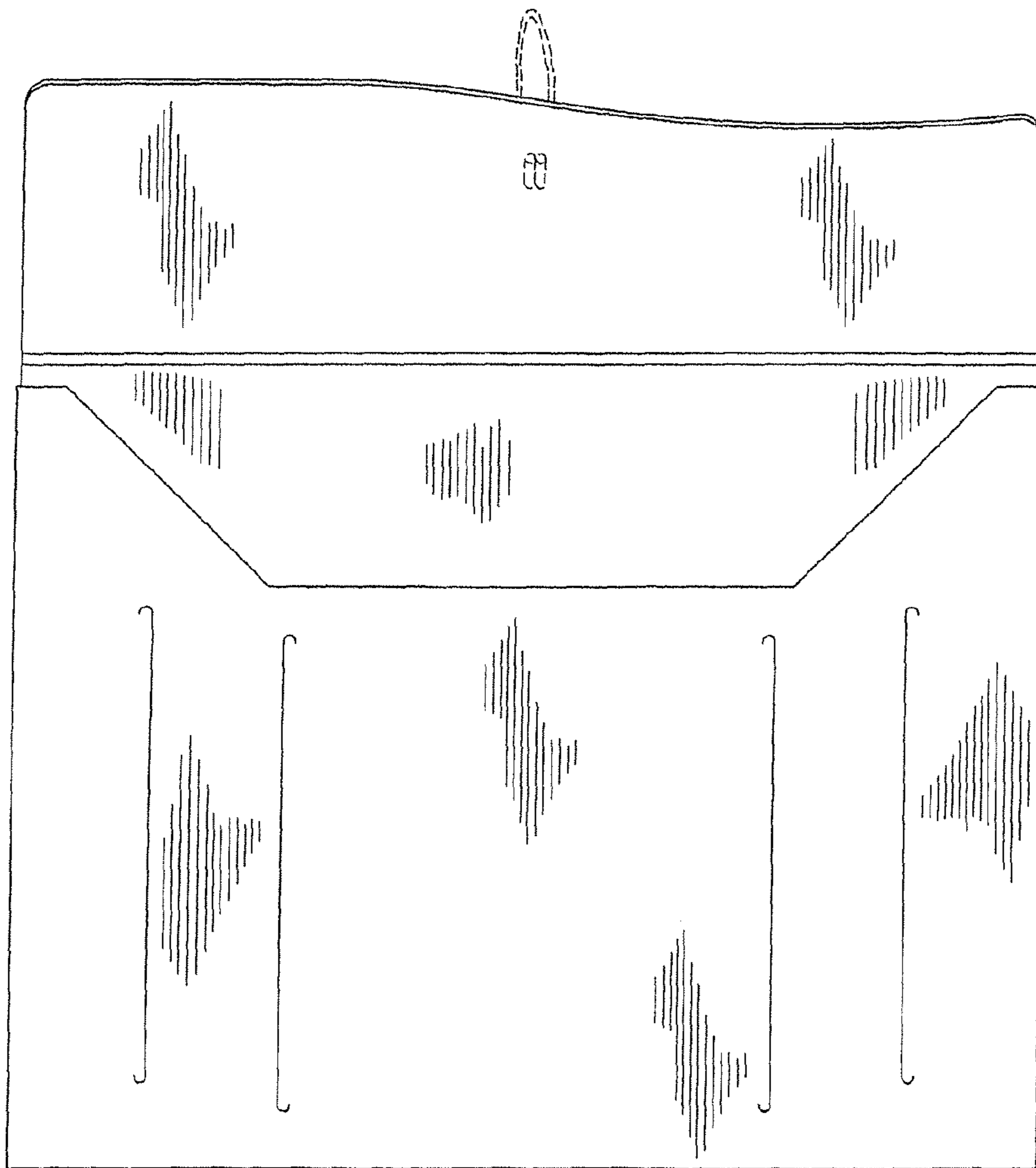

FIG. 30

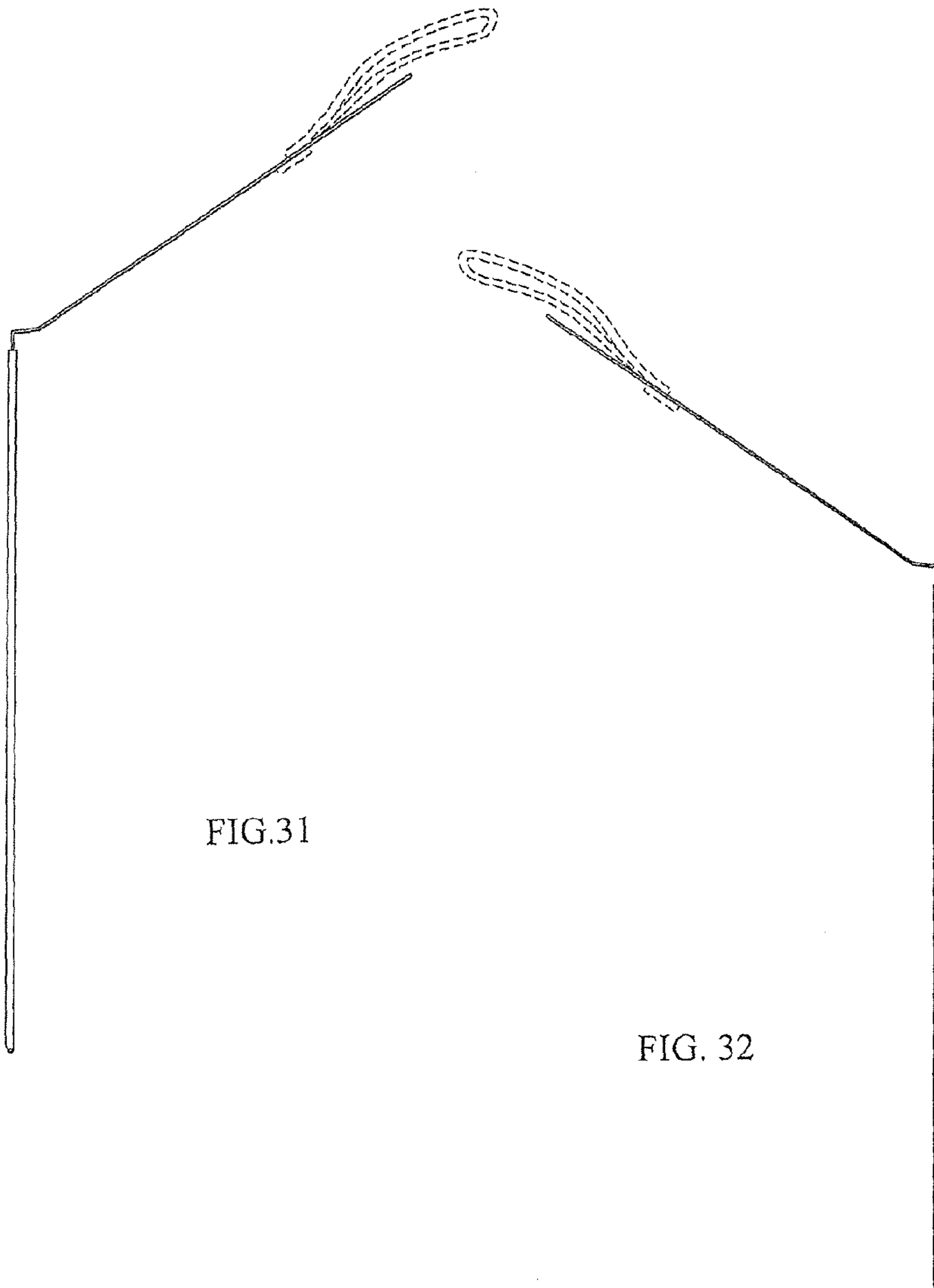

FIG.31

FIG. 32

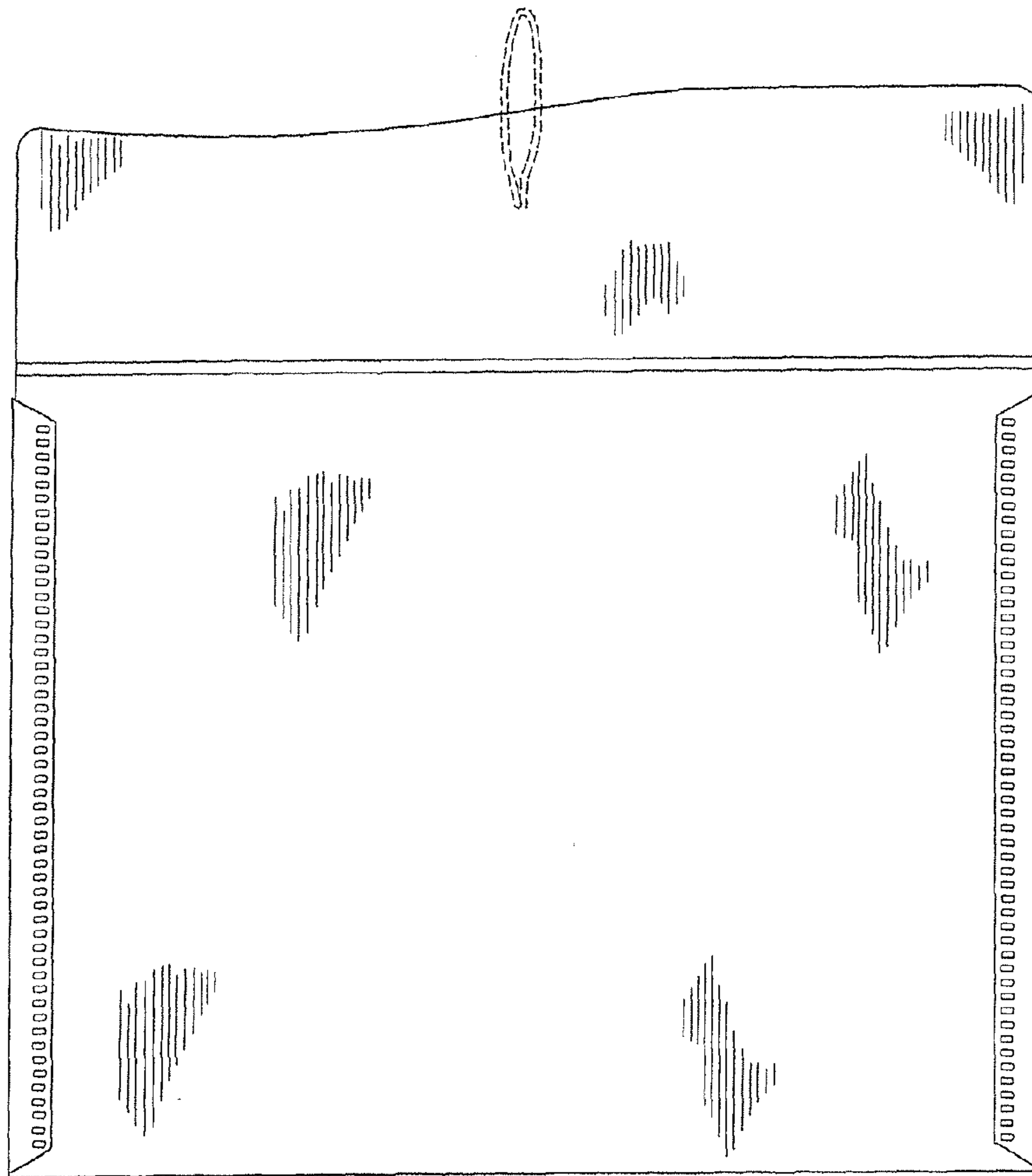

FIG. 33

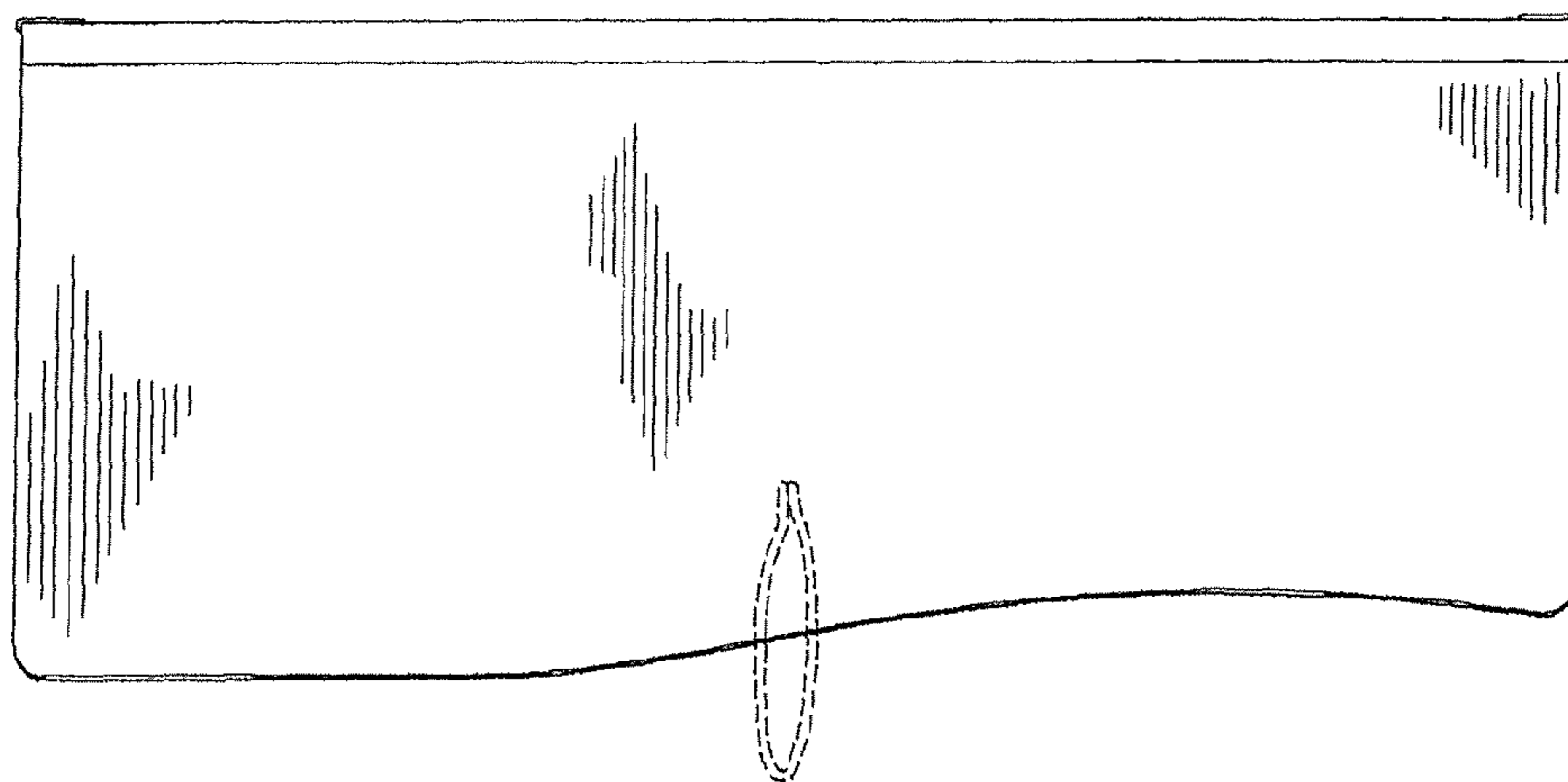

FIG. 34

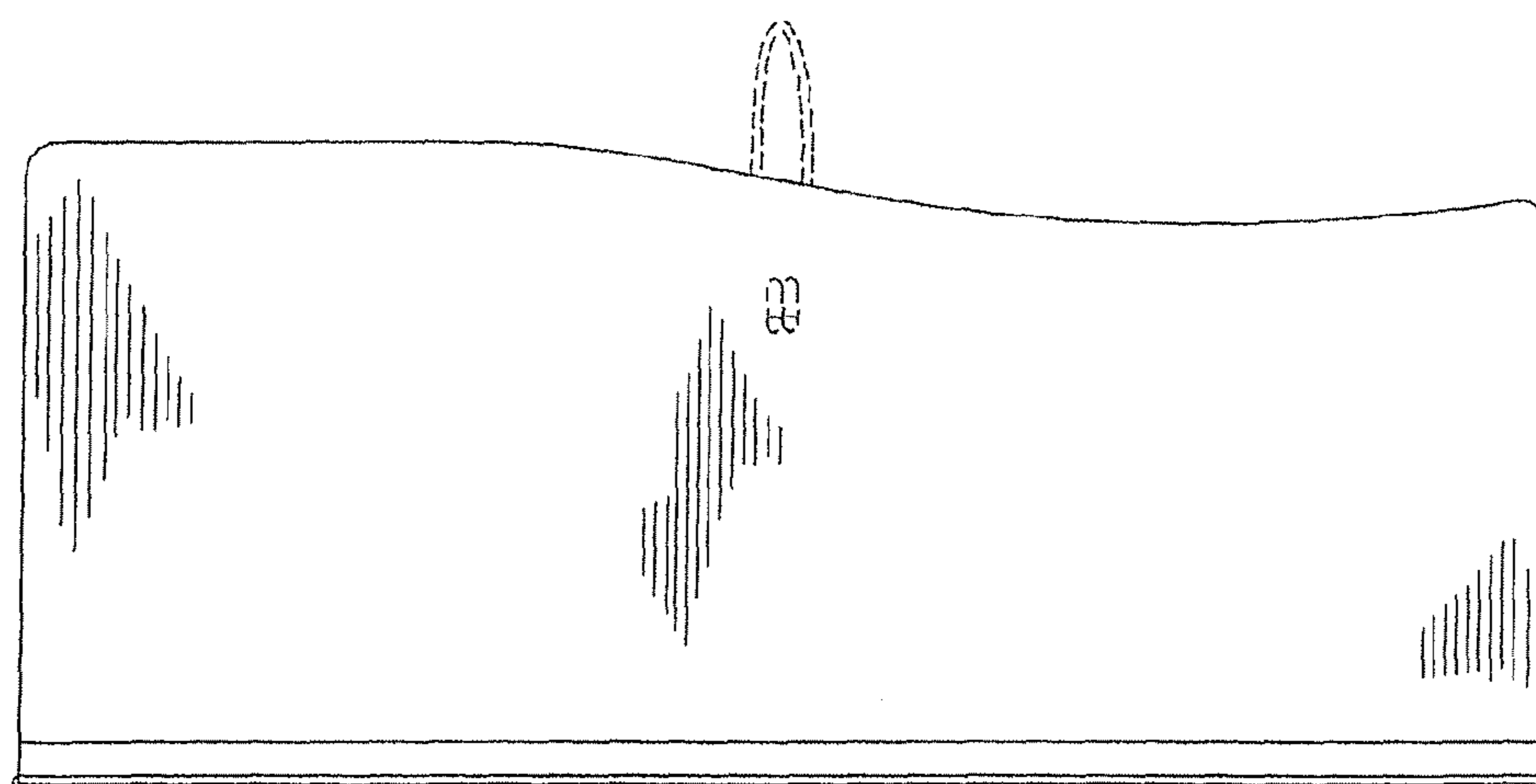

FIG. 35