



US00D709490S

(12) **United States Design Patent**  
**Lee et al.**

(10) **Patent No.:** **US D709,490 S**  
(45) **Date of Patent:** **\*\* Jul. 22, 2014**

(54) **NOTEBOOK COMPUTER**

(71) Applicant: **Samsung Electronics Co., Ltd.**,  
Suwon-si (KR)

(72) Inventors: **Chang-Ho Lee**, Seoul (KR); **Zi-On  
Kwon**, Seoul (KR)

(73) Assignee: **Samsung Electronics Co., Ltd.**,  
Suwon-si (KR)

(\*\*) Term: **14 Years**

(21) Appl. No.: **29/446,927**

(22) Filed: **Feb. 28, 2013**

(30) **Foreign Application Priority Data**

Aug. 28, 2012 (KR) ..... 30-2012-0041293

(51) **LOC (10) Cl.** ..... **14-02**

(52) **U.S. Cl.**  
USPC ..... **D14/315**

(58) **Field of Classification Search**  
USPC ..... D14/315-327, 331; D18/1, 2, 7, 11;  
235/145 A, 145 R; 341/22, 23; 345/104,  
345/156, 168, 169, 173; 361/679.08,  
361/679.09, 679.11, 679.26, 679.27;  
379/433.12; 16/341, 367

See application file for complete search history.

(56) **References Cited**

U.S. PATENT DOCUMENTS

D528,541 S \* 9/2006 Maskatia ..... D14/315  
D535,292 S \* 1/2007 Shi et al. .... D14/315  
7,158,634 B2 \* 1/2007 Eromaki ..... 379/433.13  
7,599,487 B2 \* 10/2009 Lim ..... 379/433.12

7,690,576 B2 \* 4/2010 Ladouceur et al. .... 235/486  
D626,547 S \* 11/2010 Li et al. .... D14/316  
2005/0044665 A1 \* 3/2005 Kuramochi ..... 16/341

\* cited by examiner

*Primary Examiner* — Freda S Nunn  
(74) *Attorney, Agent, or Firm* — NSIP Law

(57) **CLAIM**

The ornamental design for a notebook computer, as shown and described.

**DESCRIPTION**

FIG. 1 is a front perspective view of a notebook computer; FIG. 2 is a front view of the notebook computer of FIG. 1; FIG. 3 is a rear view of the notebook computer of FIG. 1; FIG. 4 is a left-side view of the notebook computer of FIG. 1; FIG. 5 is a right-side view of the notebook computer of FIG. 1; FIG. 6 is a top plan view of the notebook computer of FIG. 1; FIG. 7 is a bottom plan view of the notebook computer of FIG. 1; FIG. 8 is an open perspective view of the notebook computer of FIG. 1; FIG. 9 is a front view of the notebook computer of FIG. 8; FIG. 10 is a rear view of the notebook computer of FIG. 8; FIG. 11 is a left-side view of the notebook computer of FIG. 8; FIG. 12 is a right-side view of the notebook computer of FIG. 8; FIG. 13 is a top plan view of the notebook computer of FIG. 8; and, FIG. 14 is a bottom plan view of the notebook computer of FIG. 8. Features shown in broken lines in FIGS. 1, 3, 4, 5, 6, 7, 8, 9, 10, 11, 12, 13, and 14, form no part of the claimed design.

**1 Claim, 11 Drawing Sheets**

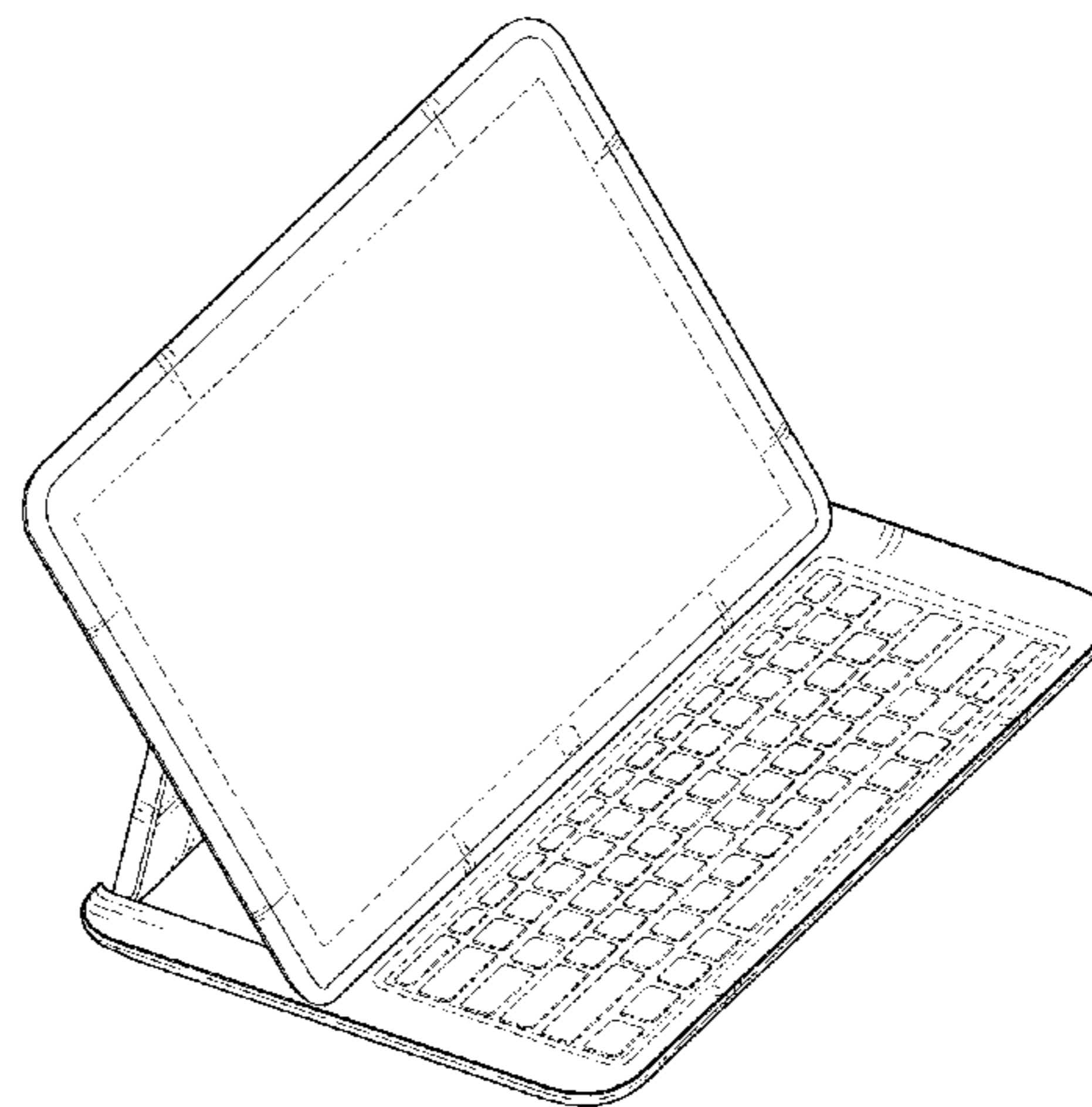
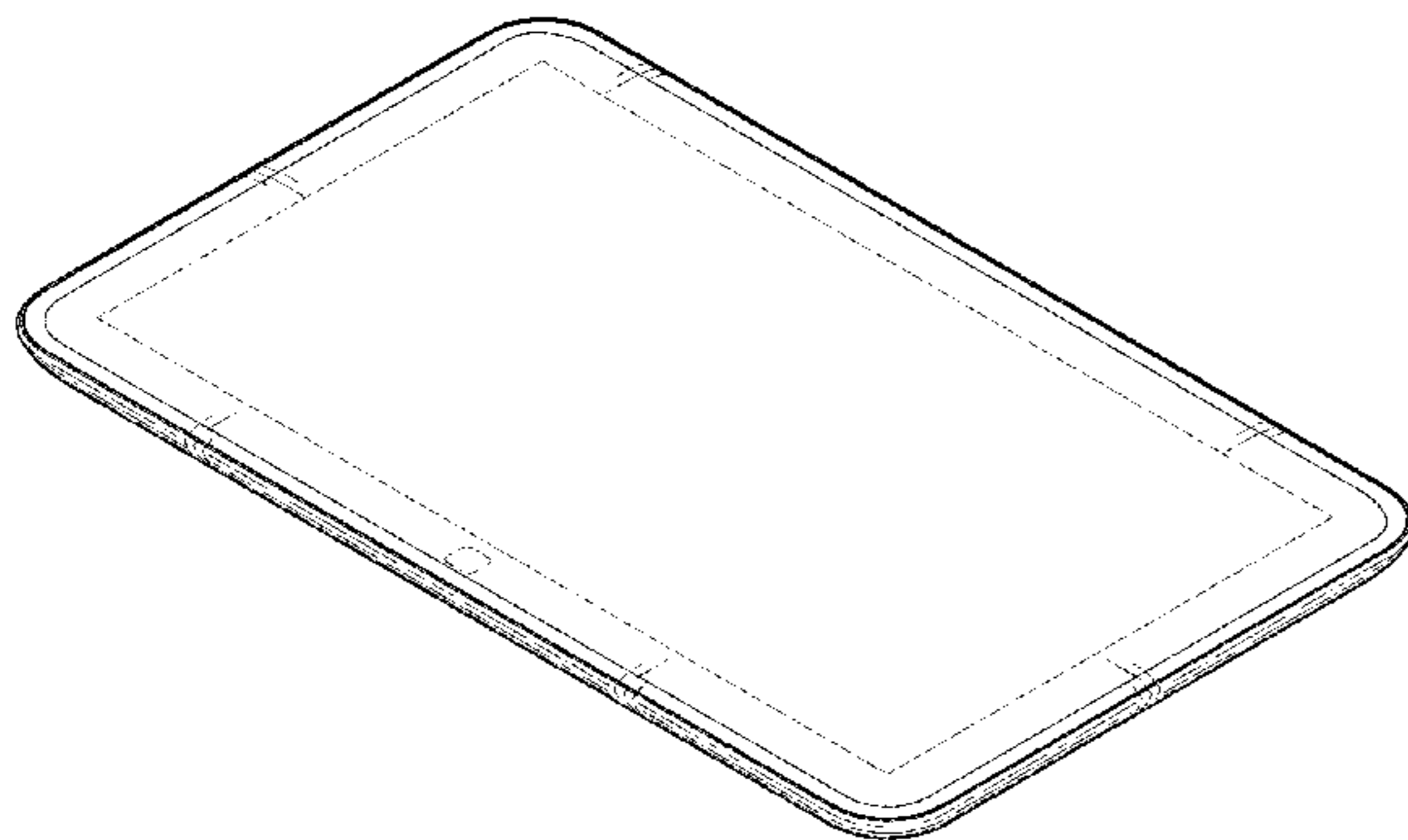

FIG. 1

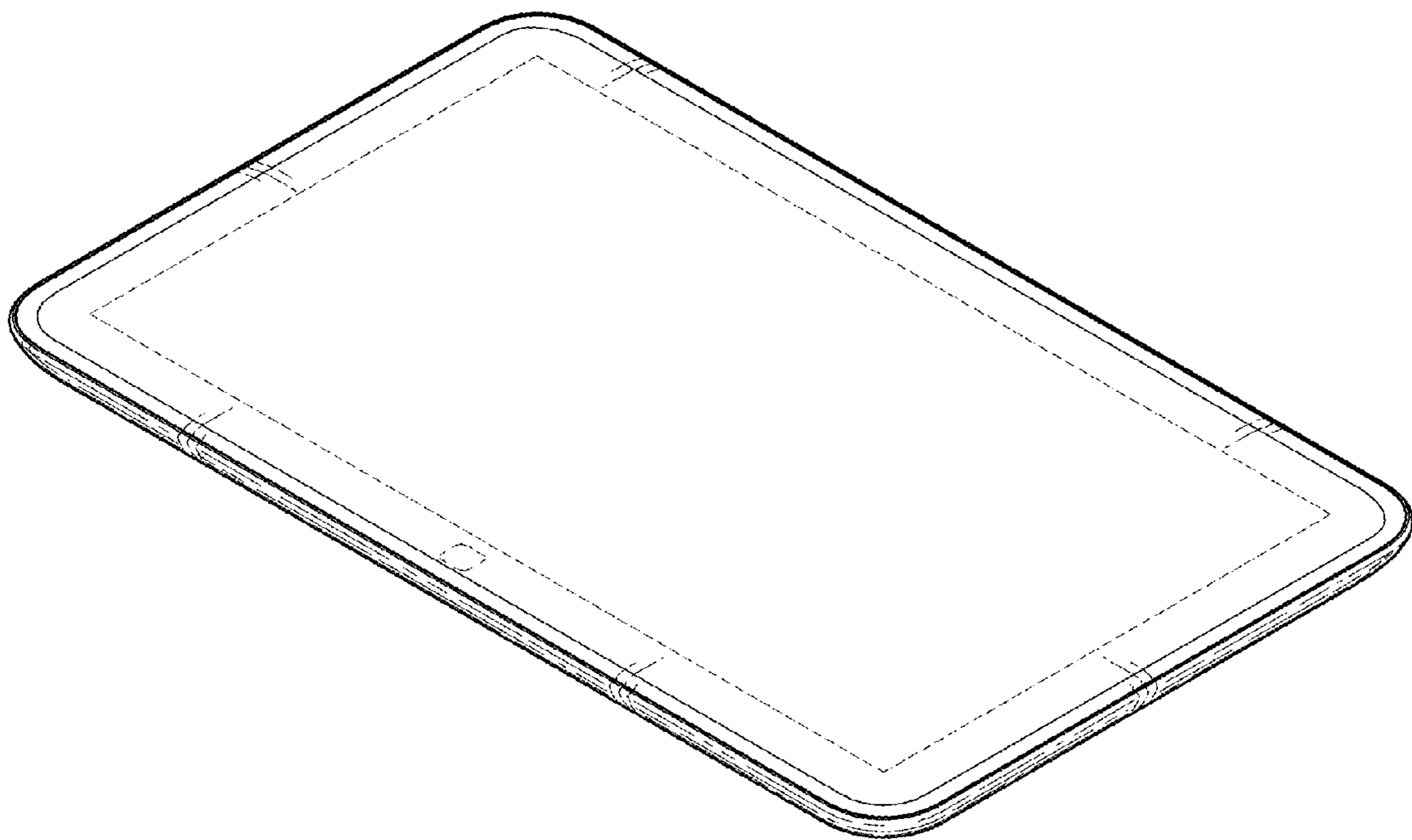

FIG. 2

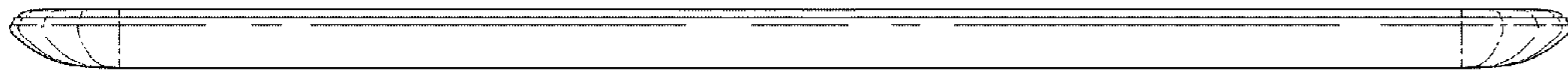

FIG. 3

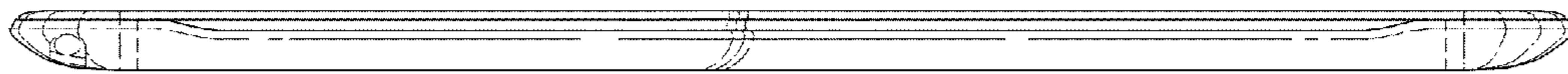

FIG. 4



FIG. 5

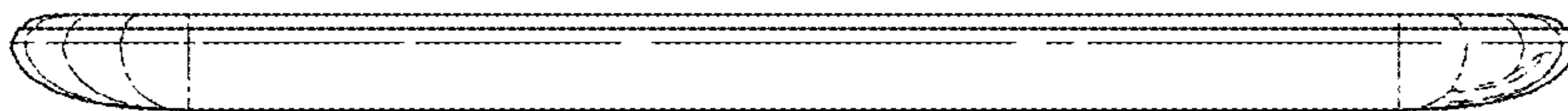

FIG. 6

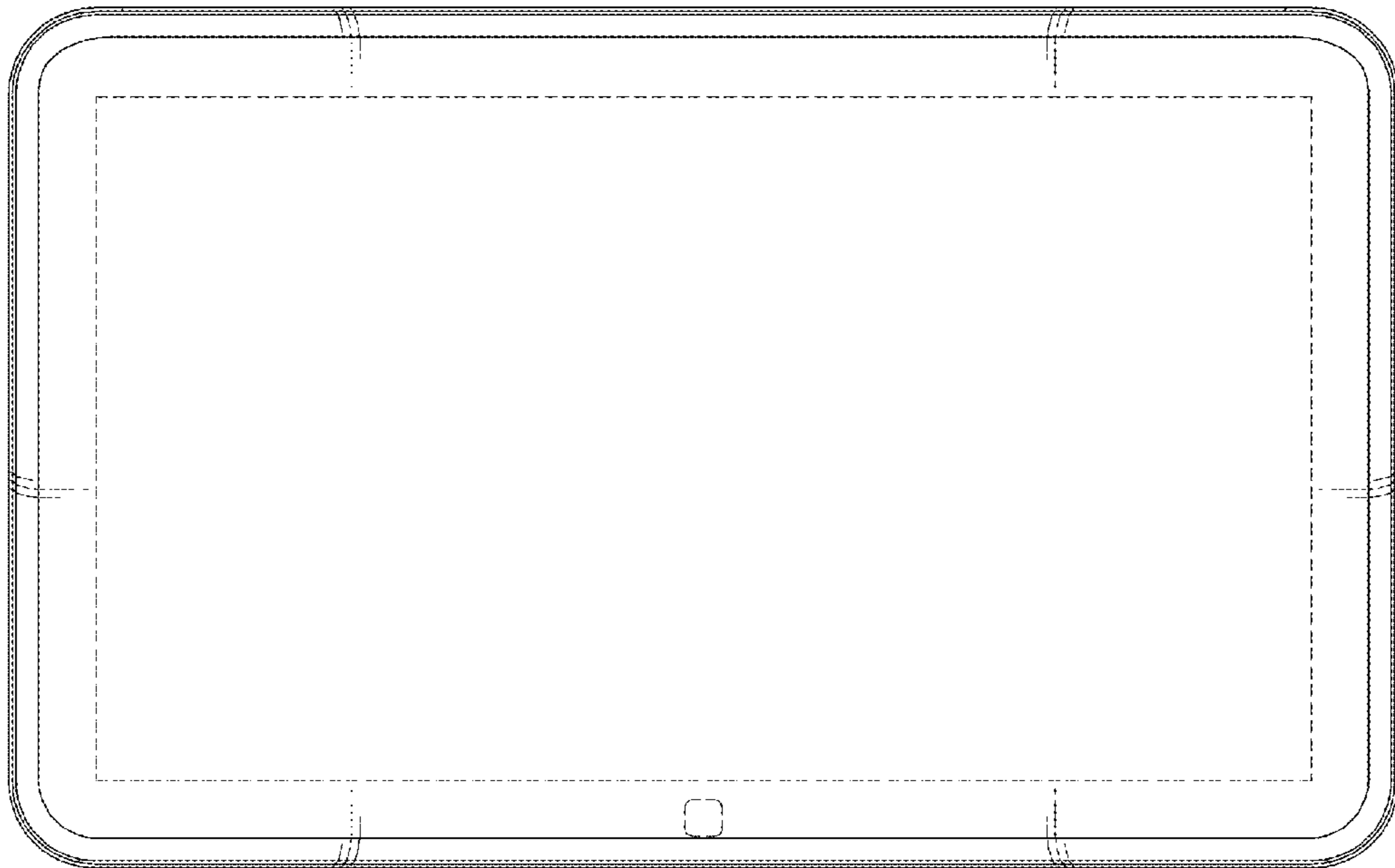

FIG. 7

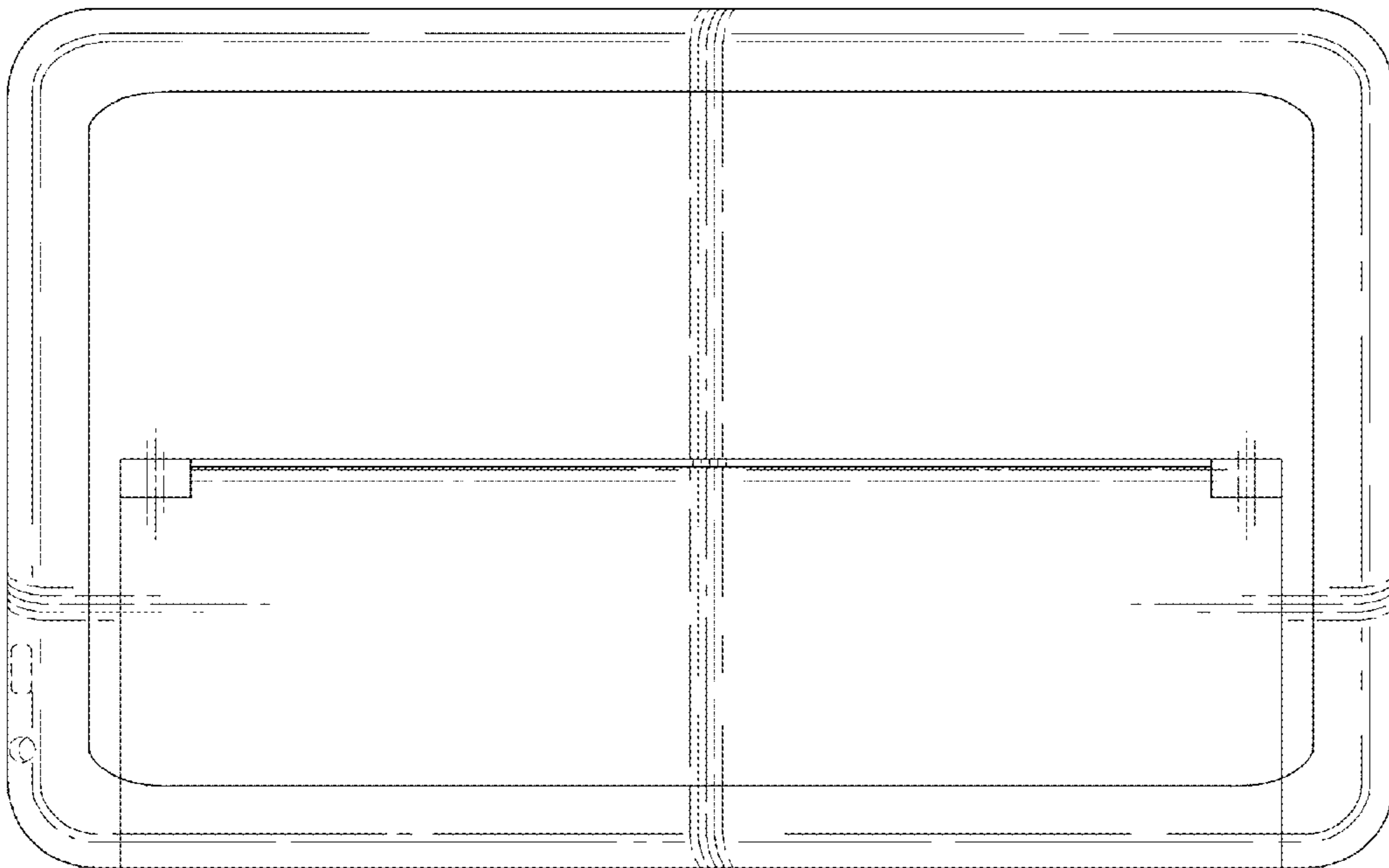

FIG. 8

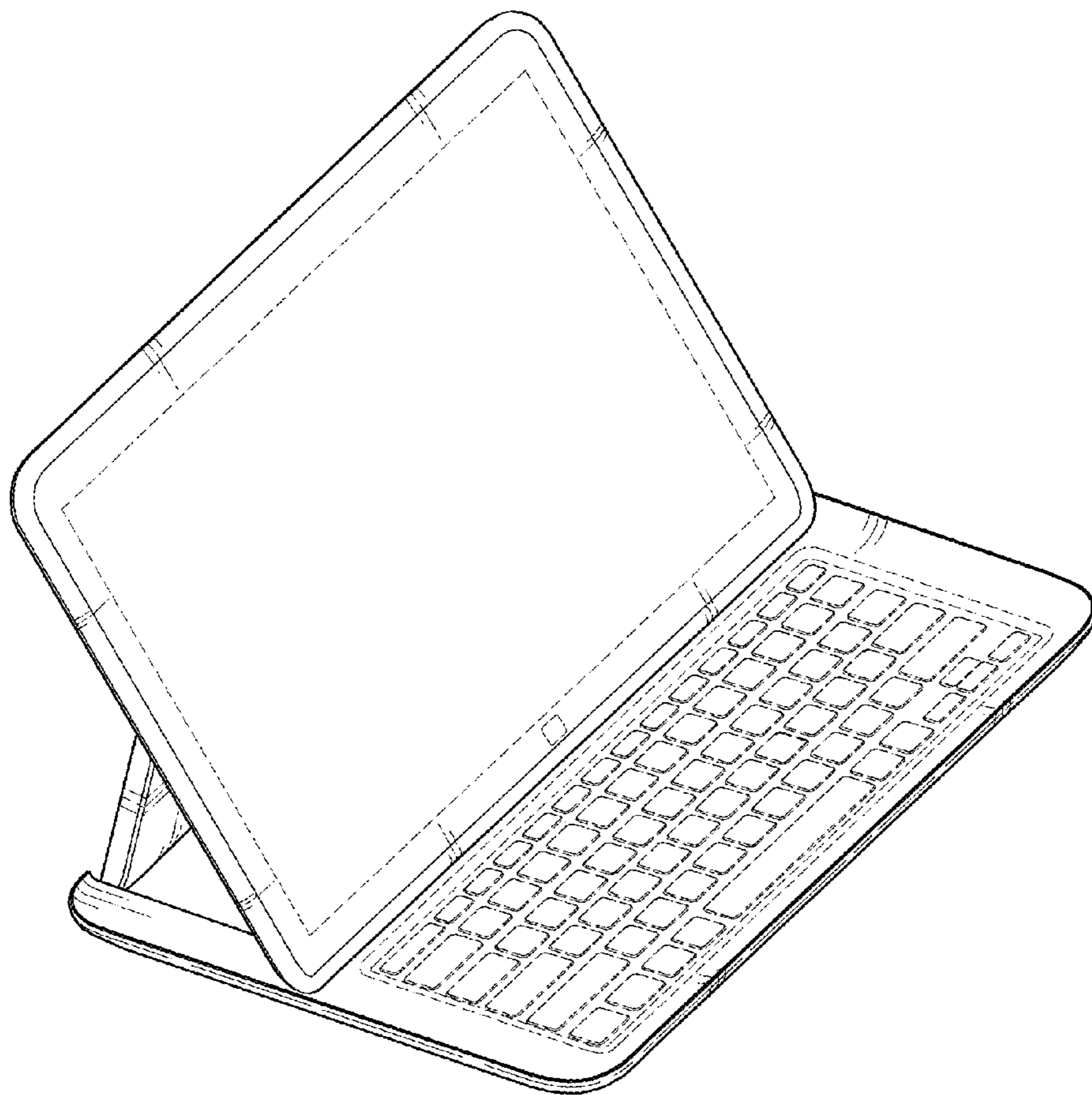

FIG. 9

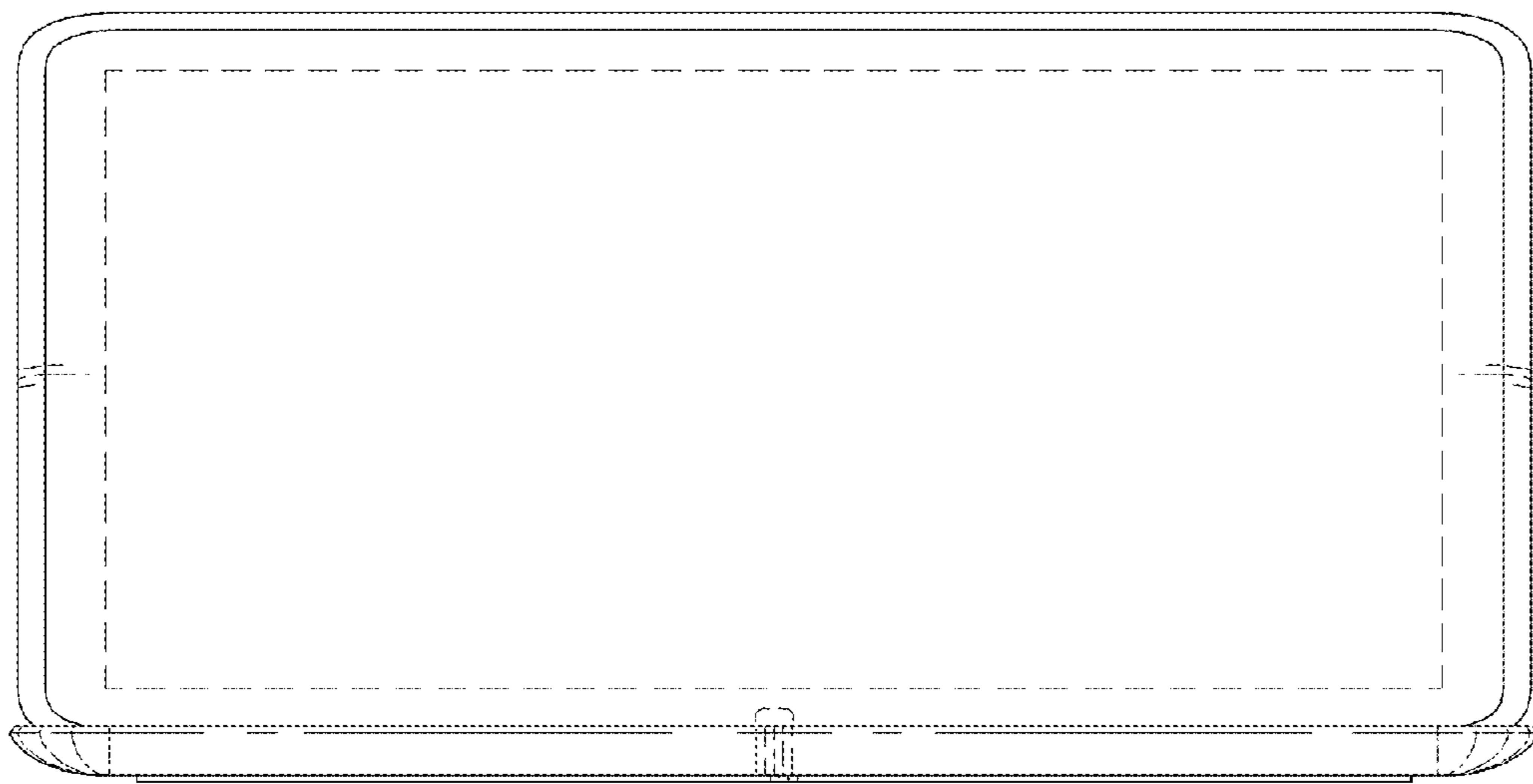



FIG. 10

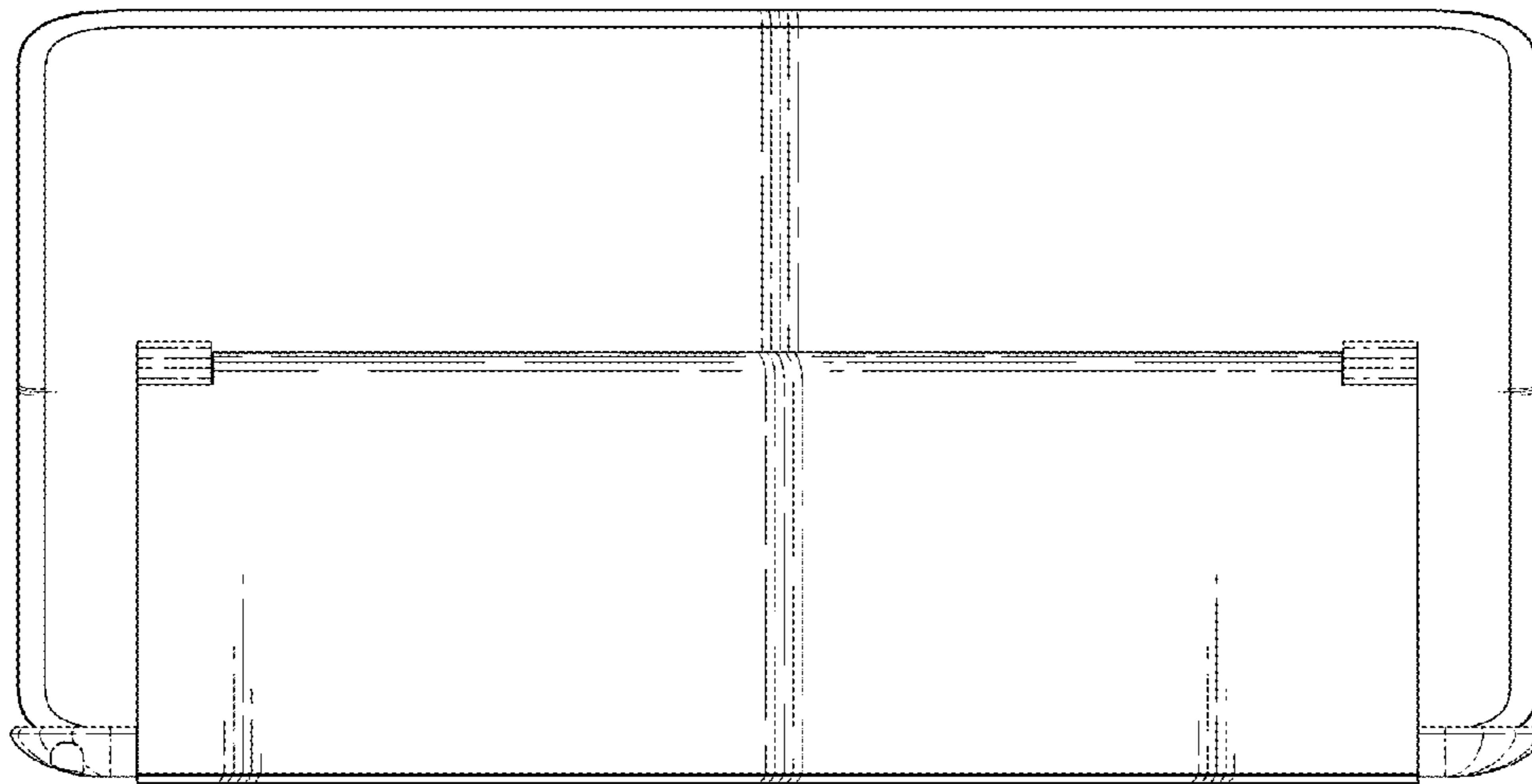

FIG. 11

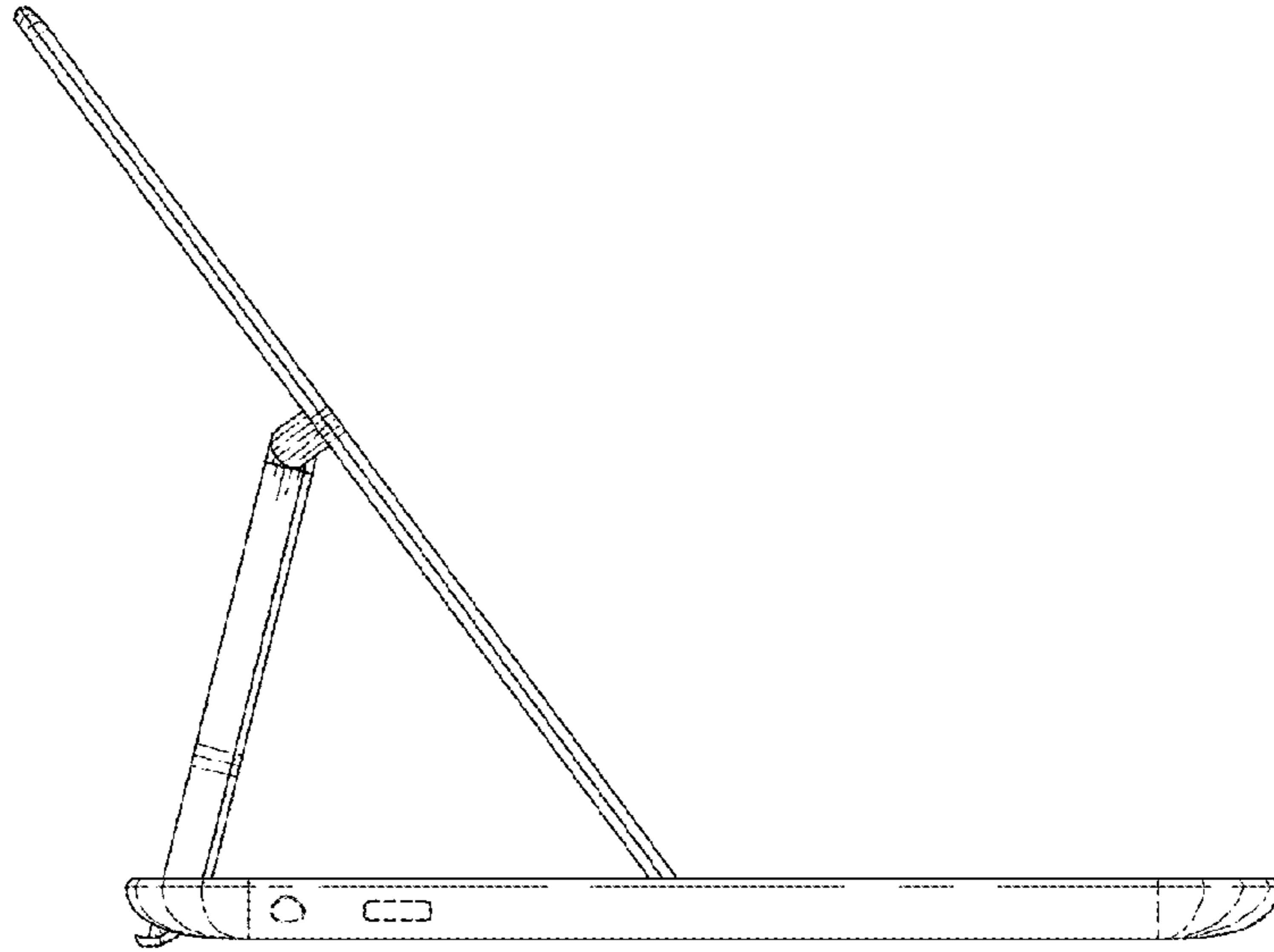

FIG. 12

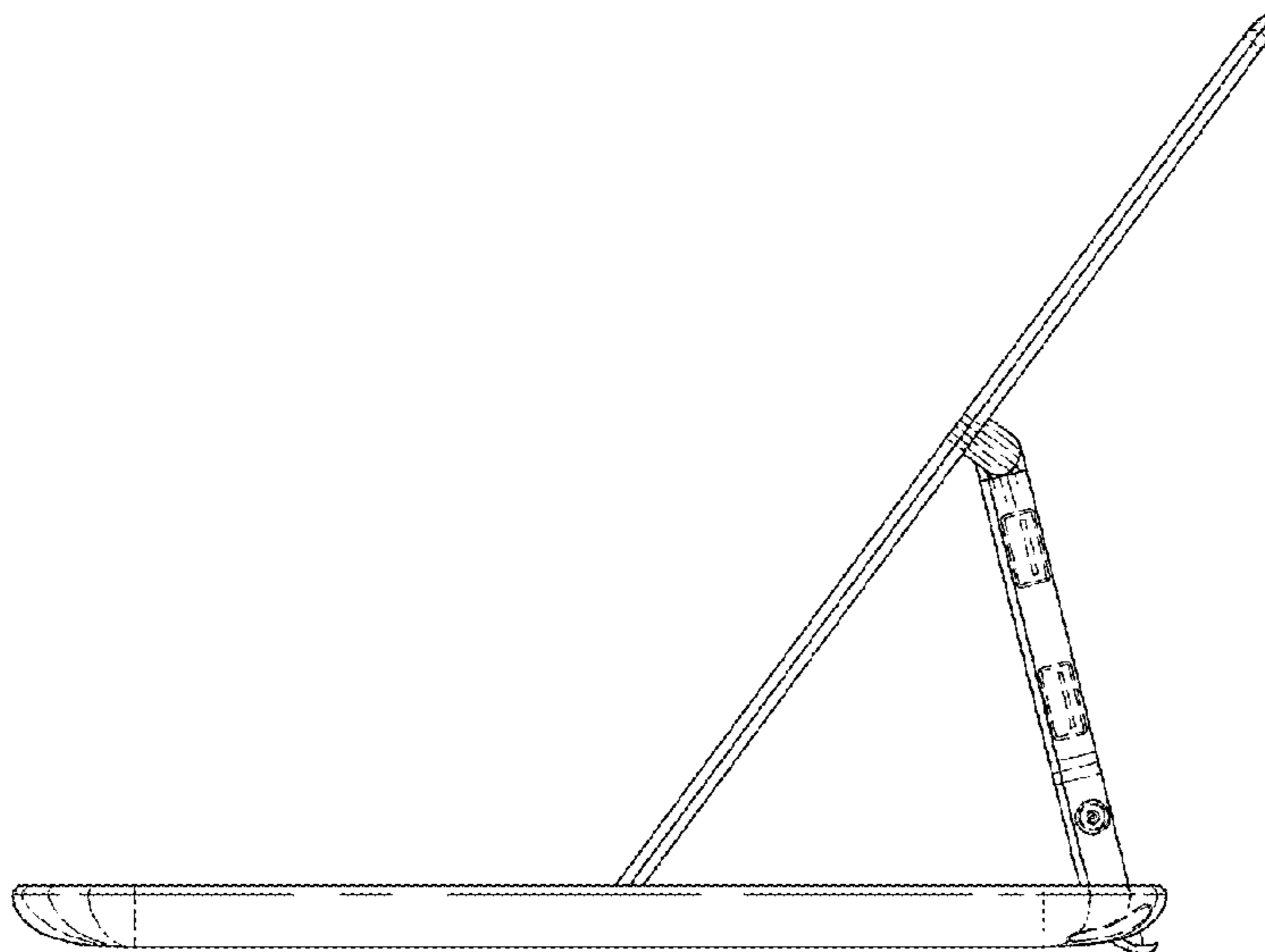

FIG. 13

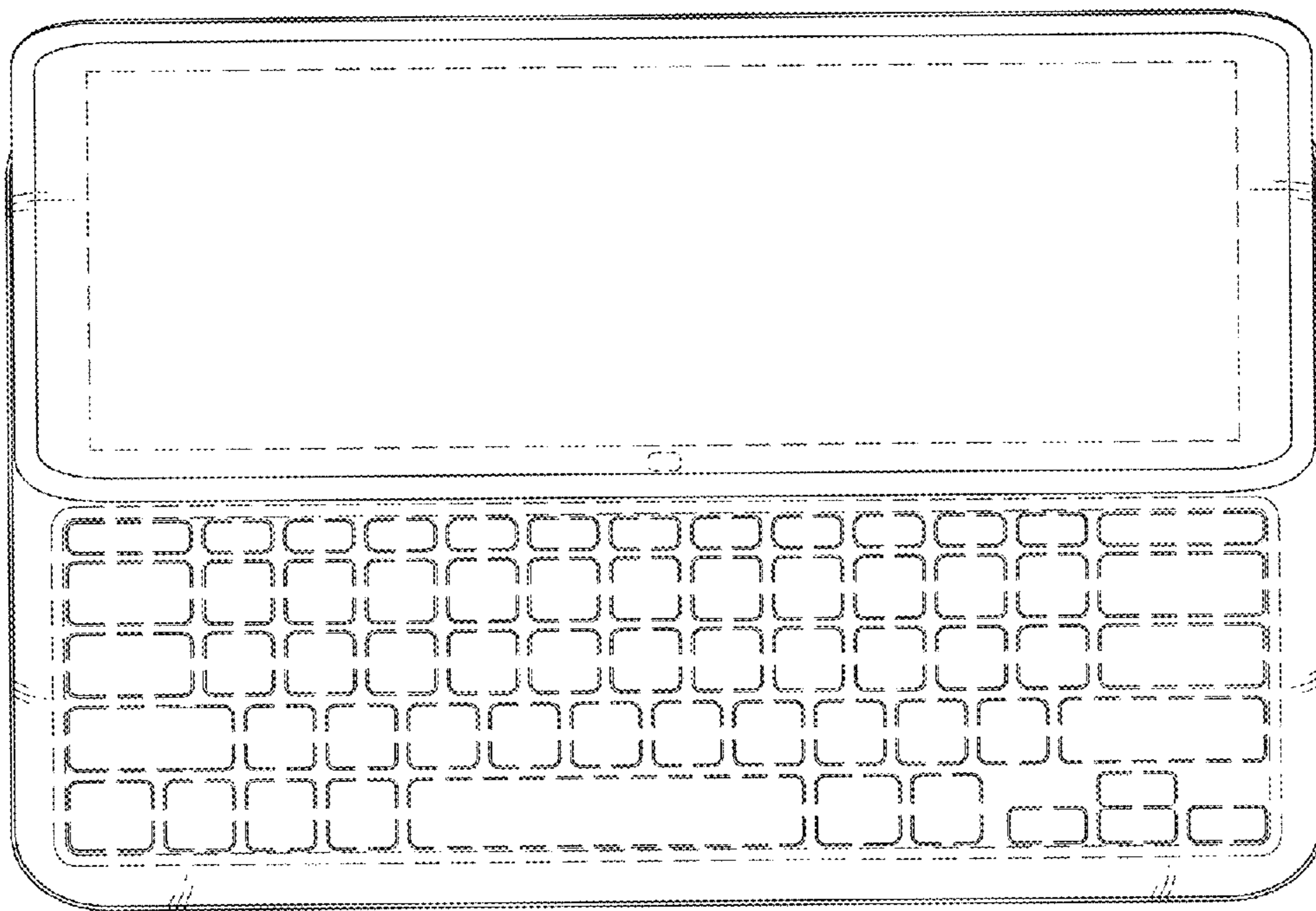

FIG. 14

