



US00D709449S

(12) **United States Design Patent**
Oba et al.

(10) **Patent No.:** **US D709,449 S**

(45) **Date of Patent:** **** Jul. 22, 2014**

(54) **POWER INVERTER**

D627,725 S * 11/2010 Gebert D13/118
D644,603 S * 9/2011 Liu D13/102
D667,784 S * 9/2012 Choi D13/102

(71) Applicant: **SANYO Electric Co., Ltd.**, Moriguchi
(JP)

FOREIGN PATENT DOCUMENTS

(72) Inventors: **Hideki Oba**, Moriguchi (JP); **Akira Otsuki**, Moriguchi (JP)

JP 1065782 S 4/2000
JP 1298803 S 4/2007
JP 1339315 S 9/2008
JP 1401157 S 11/2010
JP 1456023 S 11/2012
JP 1462452 S 2/2013

(73) Assignee: **SANYO Electric Co., Ltd.**,
Moriguchi-shi (JP)

(**) Term: **14 Years**

* cited by examiner

(21) Appl. No.: **29/468,308**

Primary Examiner — Derrick Holland

(22) Filed: **Sep. 27, 2013**

(74) *Attorney, Agent, or Firm* — Westerman, Hattori,
Daniels & Adrian, LLP

(51) **LOC (10) Cl.** **13-02**

(57) **CLAIM**

(52) **U.S. Cl.**

The ornamental design for a power inverter, as shown and described.

USPC **D13/110**

(58) **Field of Classification Search**

DESCRIPTION

USPC D13/110, 108, 118, 123, 162, 168, 169,
D13/174, 177, 184, 199; D10/103;
D14/257, 432, 438; 16/404; 334/7, 10;
337/186; 361/600, 601, 692, 730;
363/141, 142

See application file for complete search history.

FIG. 1 is a front perspective view of a power inverter, showing our new design;
FIG. 2 is a front elevational view thereof;
FIG. 3 is a rear elevational view thereof;
FIG. 4 is a top plan view thereof;
FIG. 5 is a bottom plan view thereof;
FIG. 6 is a right side elevational view thereof;
FIG. 7 is a left side elevational view thereof;
FIG. 8 is a cross-sectional view thereof, taken along the line 8-8 of FIG. 2 with internal features being omitted; and,
FIG. 9 is a cross-sectional view thereof, taken along the line 9-9 of FIG. 2 with internal features being omitted.

The broken lines shown represent unclaimed subject matter and form no part of the claimed design.

(56) **References Cited**

U.S. PATENT DOCUMENTS

5,949,640 A * 9/1999 Cameron et al. 361/600
D456,771 S * 5/2002 Bloemen D13/110
D548,180 S * 8/2007 Krieger et al. D13/110
D604,237 S * 11/2009 Engel et al. D13/110
D604,239 S * 11/2009 Engel et al. D13/110
D616,815 S * 6/2010 Jadraque Aznarez
et al. D13/110
D620,885 S * 8/2010 Donth D13/110

1 Claim, 9 Drawing Sheets

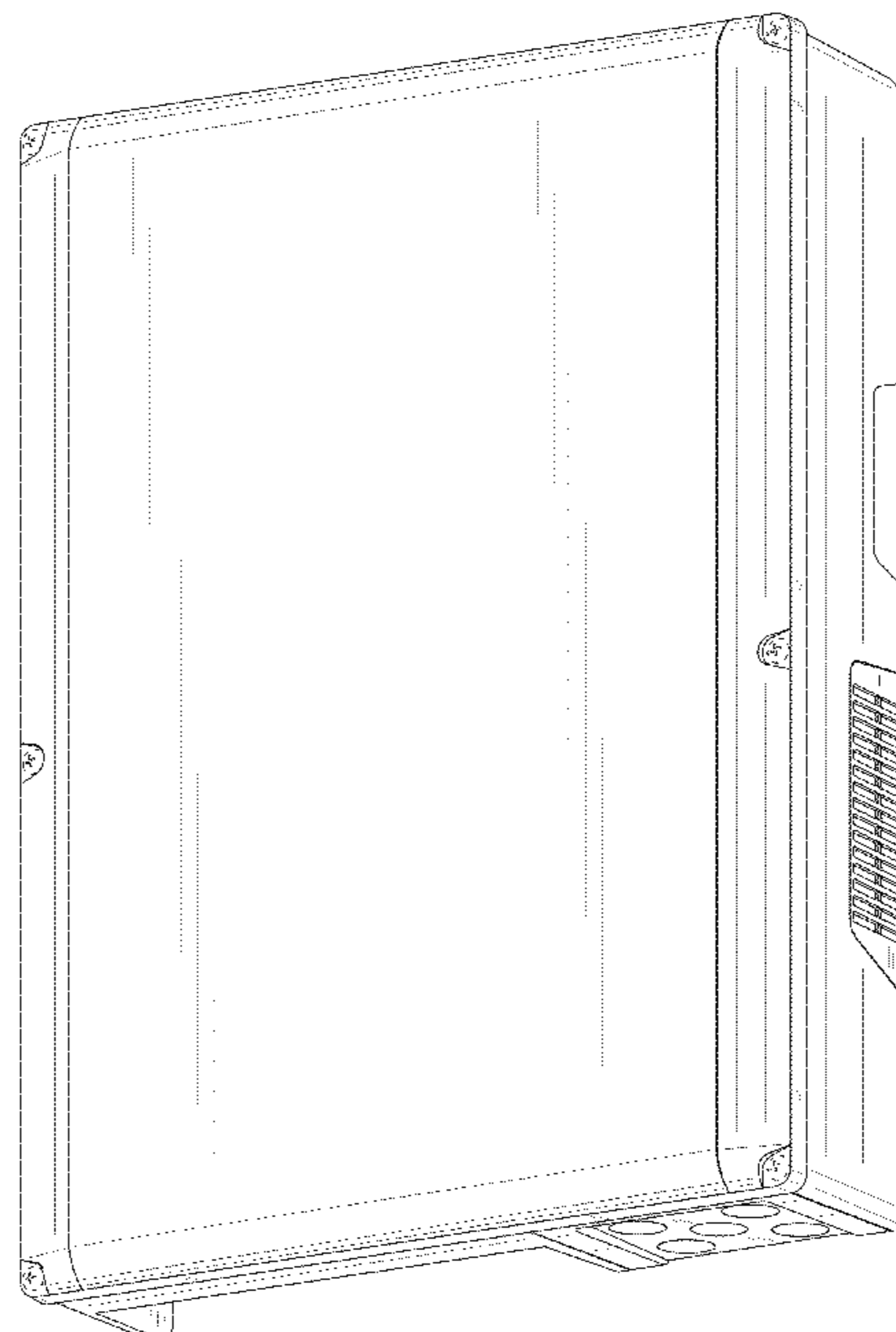

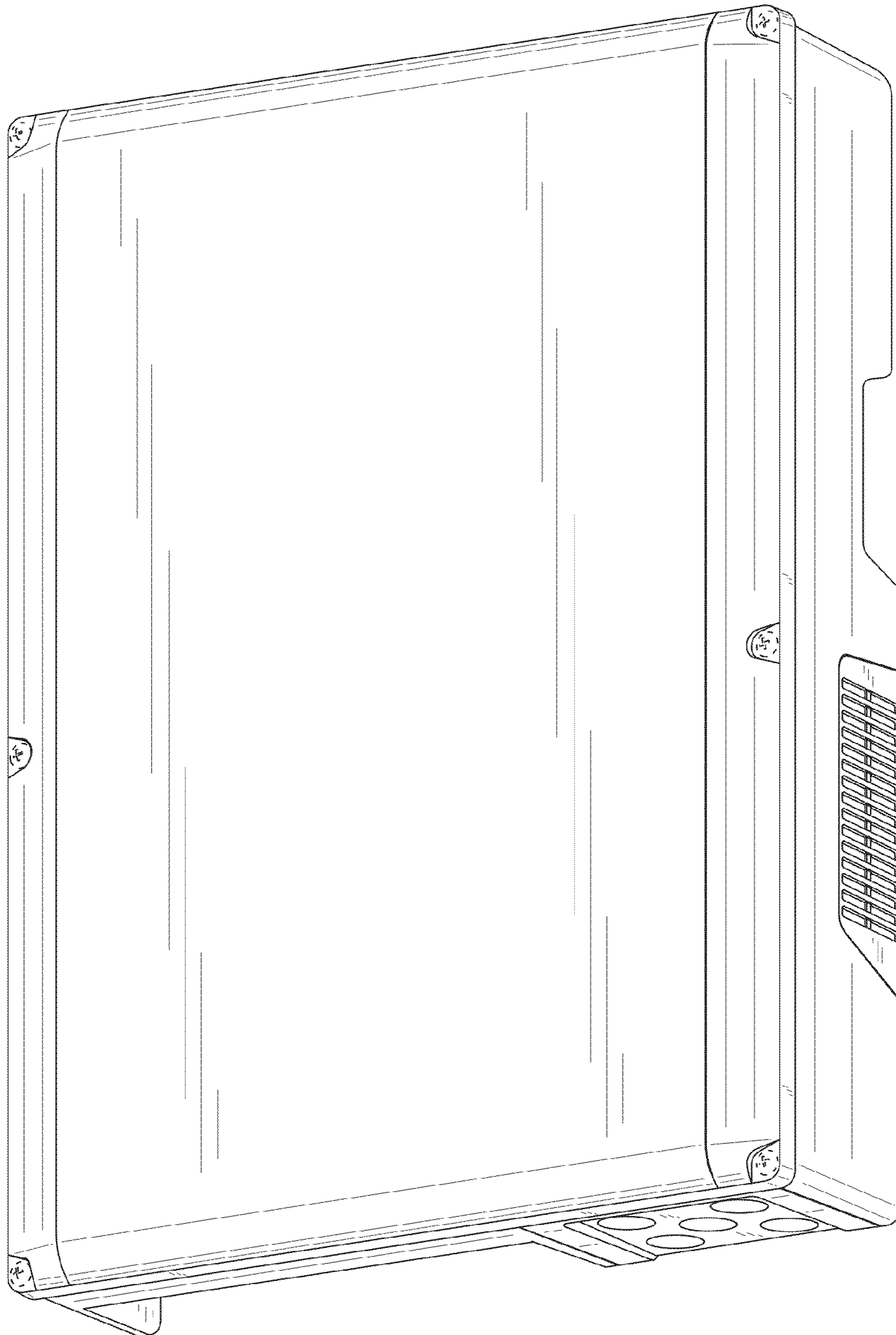

FIG.1

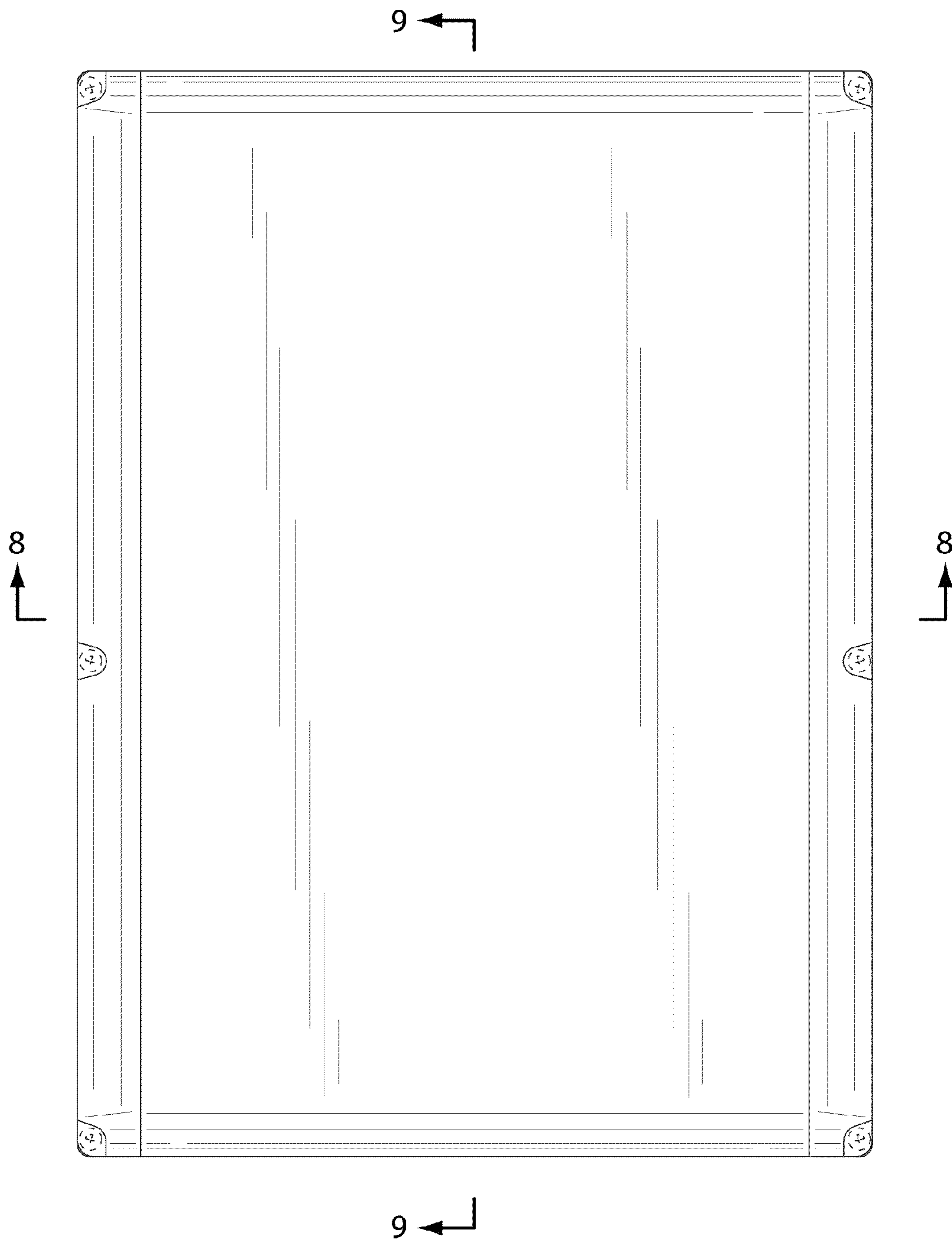

FIG. 2

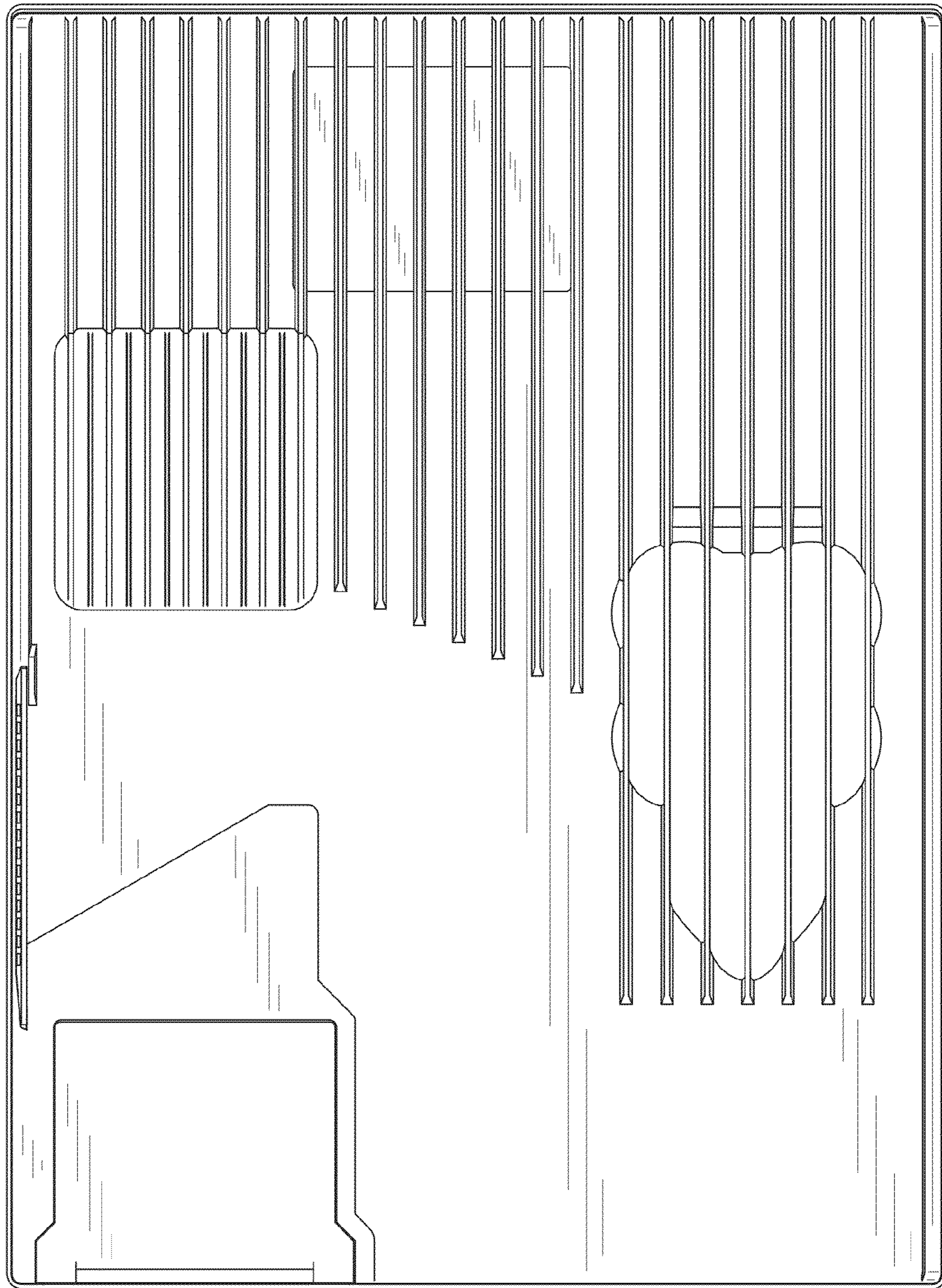

FIG.3

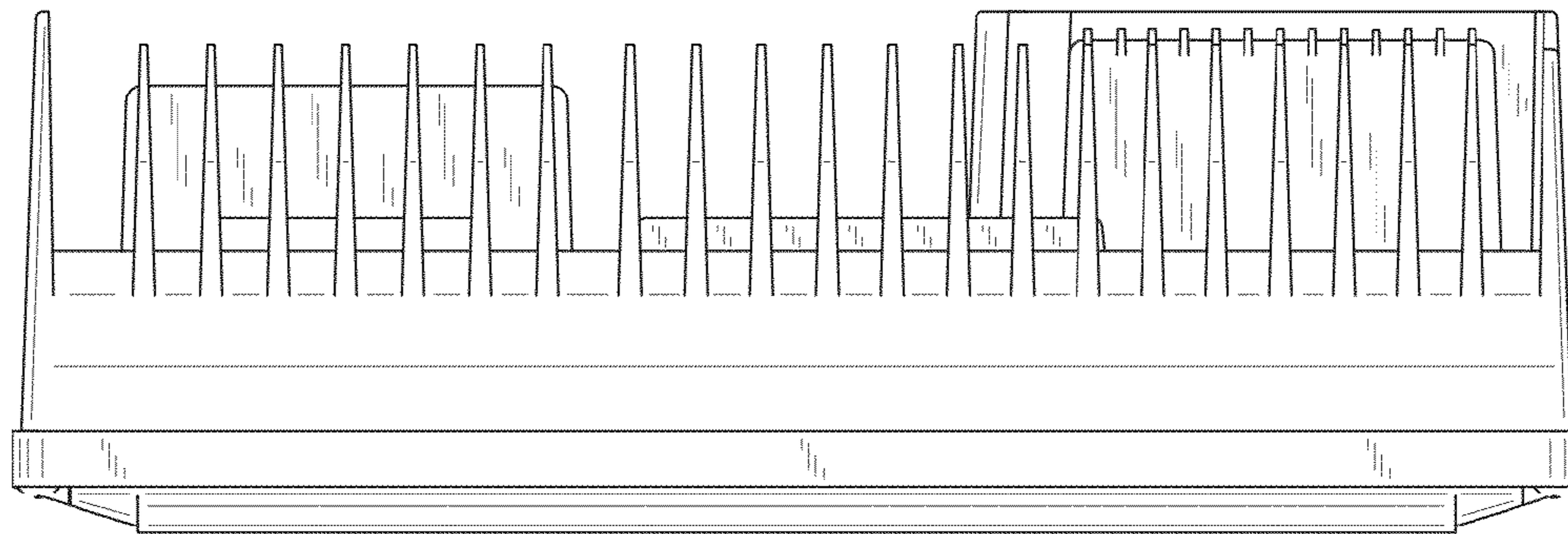

FIG.4

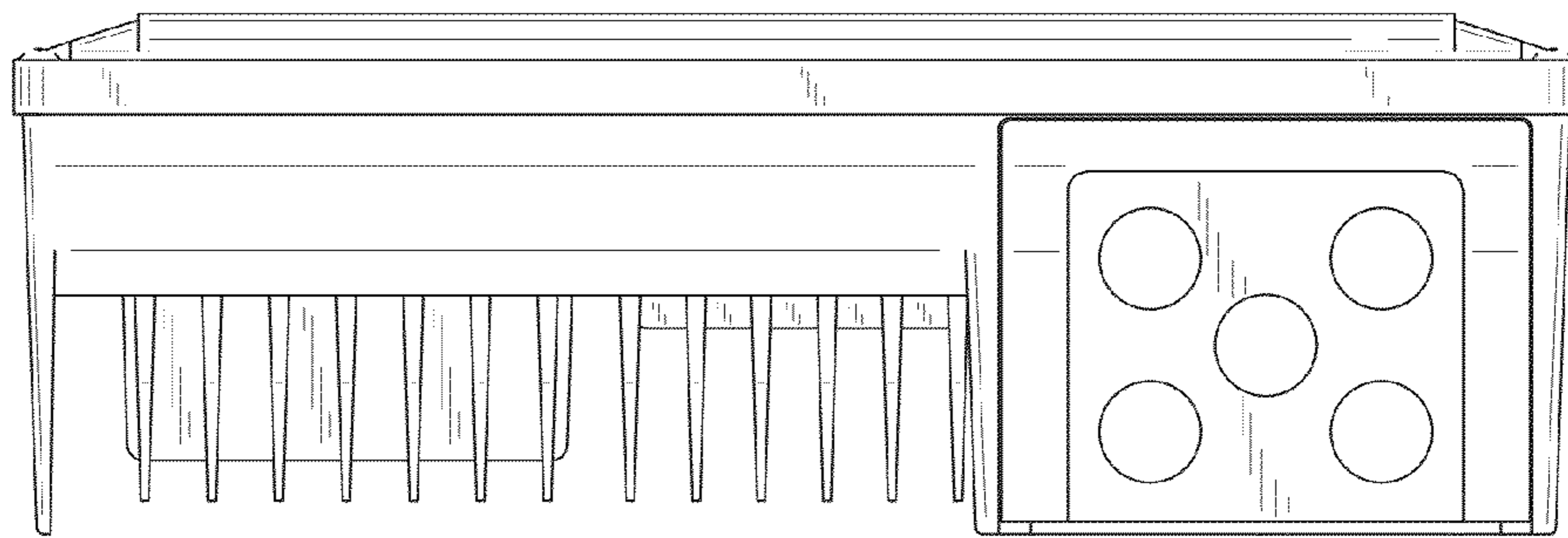

FIG.5

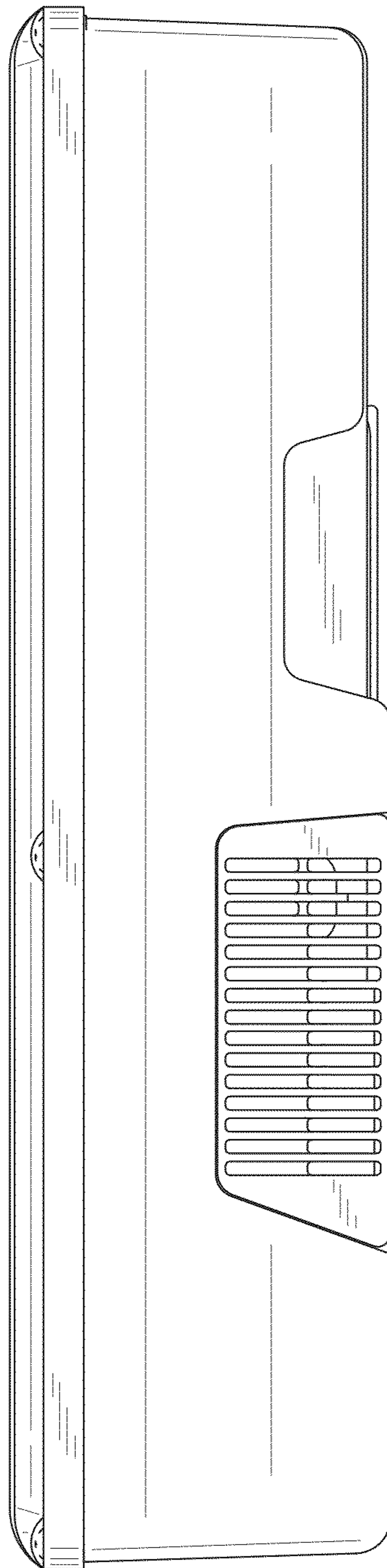

FIG.6

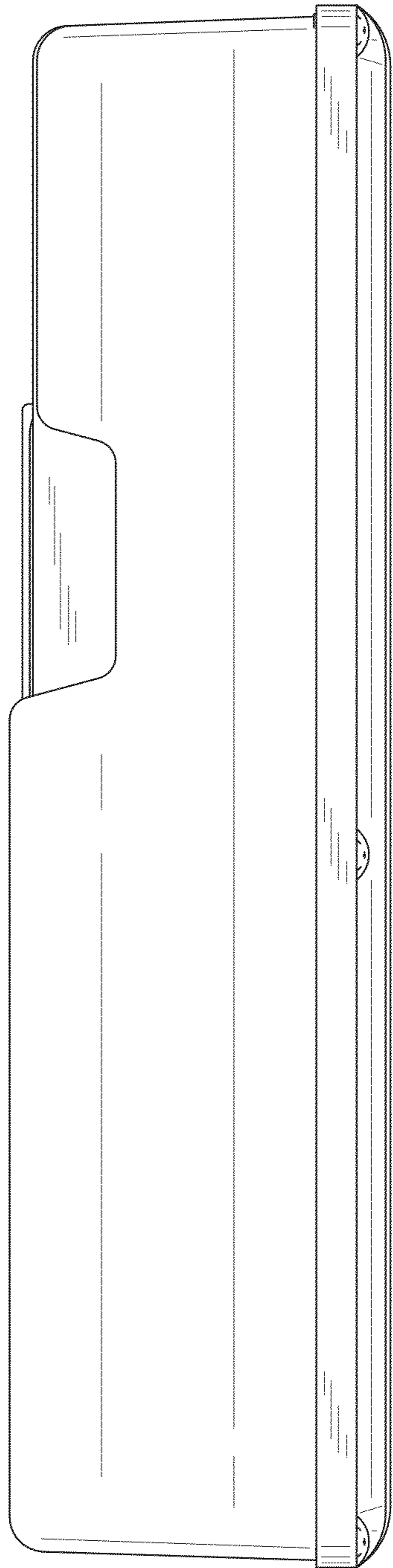

FIG.7

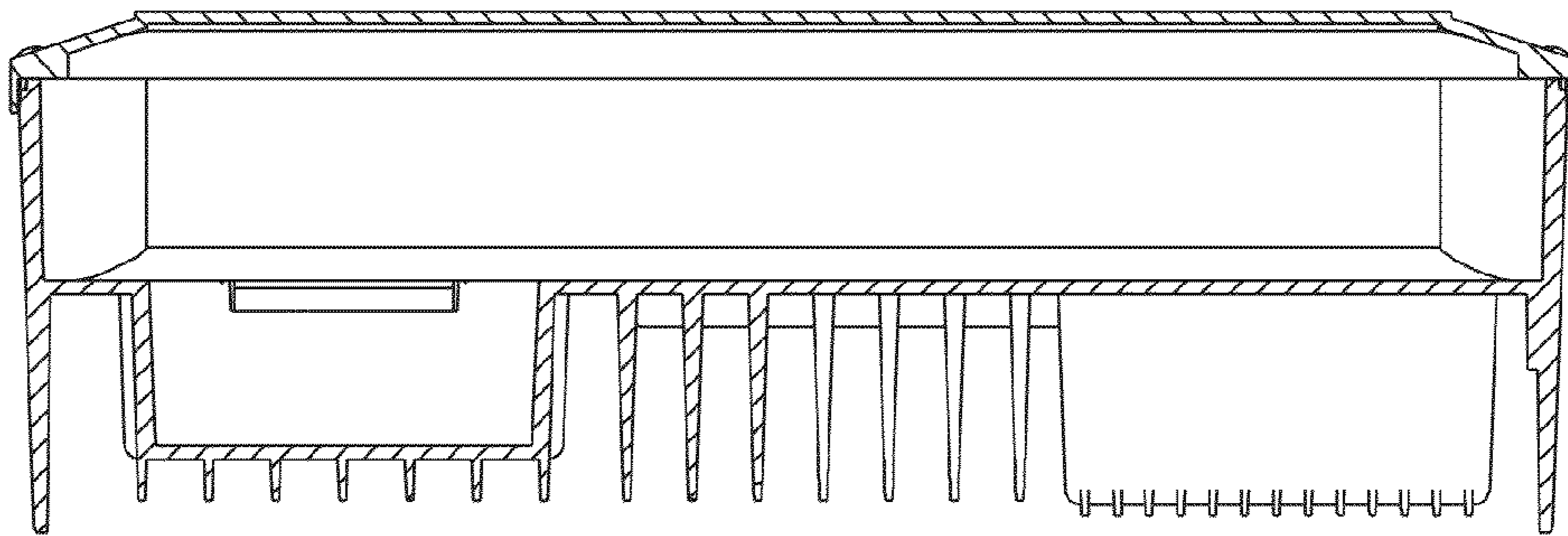

FIG.8

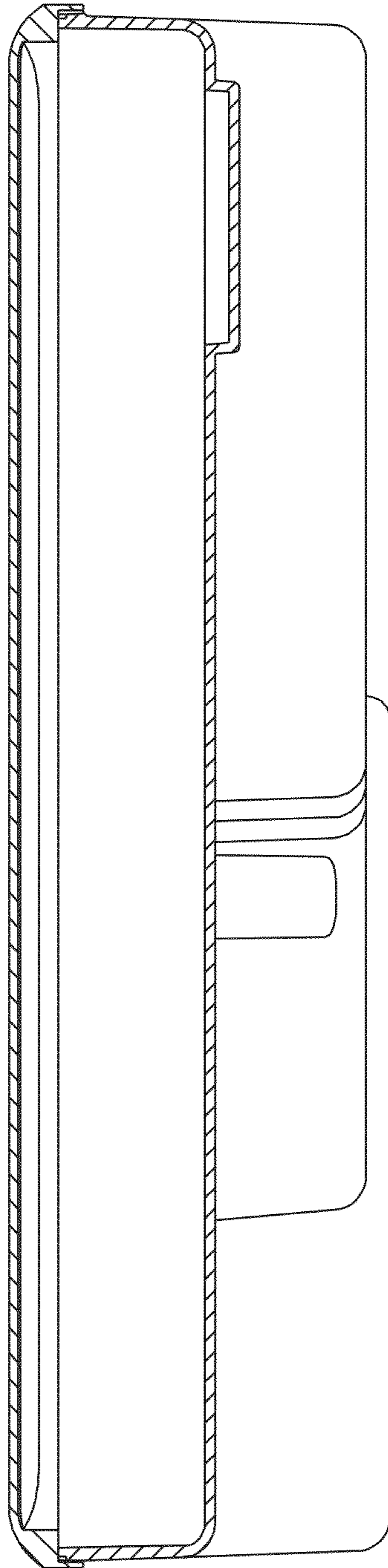

FIG.9