



US00D709419S

(12) **United States Design Patent**  
**Watkins**

(10) **Patent No.:** **US D709,419 S**  
(45) **Date of Patent:** **\*\* Jul. 22, 2014**

- (54) **VEHICLE DOOR TRIM SET**
- (71) Applicant: **Land Rover**, Warwickshire (GB)
- (72) Inventor: **James Watkins**, Warwickshire (GB)
- (73) Assignee: **Land Rover** (GB)
- (\*\*) Term: **14 Years**
- (21) Appl. No.: **29/435,120**
- (22) Filed: **Oct. 19, 2012**

(30) **Foreign Application Priority Data**

Apr. 19, 2012 (EM) ..... I 002029447  
 Aug. 13, 2012 (EM) ..... I 002087189  
 Aug. 13, 2012 (EM) ..... I 002087304

- (51) **LOC (10) Cl.** ..... **12-08**
- (52) **U.S. Cl.**  
USPC ..... **D12/190; D12/196**

- (58) **Field of Classification Search**  
USPC ..... D12/86, 90, 91, 92, 114, 163, 169, 171,  
D12/172, 173, 181, 190, 196, 197, 199,  
D12/400; D11/81, 133, 157, 172, 211;  
D20/11, 23, 24, 25; 293/102, 115;  
296/1.07-1.08; 40/413, 760; 428/931,  
428/8-99

See application file for complete search history.

(56) **References Cited**

**U.S. PATENT DOCUMENTS**

D289,891 S \* 5/1987 Bielby ..... D12/190  
 D342,476 S \* 12/1993 Beckett ..... D12/203

(Continued)

**FOREIGN PATENT DOCUMENTS**

JP 11310083 A \* 11/1999 ..... B60R 3/00

*Primary Examiner* — Philip S Hyder

*Assistant Examiner* — Darlington Ly

(74) *Attorney, Agent, or Firm* — Rader, Fishman & Grauer PLLC

(57) **CLAIM**

The ornamental design for a vehicle door trim set, as shown and described.

**DESCRIPTION**

FIG. 1 is a front perspective view of the front left-side component for the vehicle door trim set;  
 FIG. 2 is a rear perspective view thereof;  
 FIG. 3 is an exterior side elevation view thereof;  
 FIG. 4 is an enlarged front view thereof;  
 FIG. 5 is an enlarged rear view thereof; and  
 FIG. 6 is a top plan view thereof.  
 FIG. 7 is a rear elevation view of the front left-side component for the vehicle door trim set installed into an environmental front door panel;  
 FIG. 8 is a front elevation view thereof;  
 FIG. 9 is a front perspective view thereof;  
 FIG. 10 is a rear perspective view thereof; and  
 FIG. 11 is an exterior side view thereof.  
 FIG. 12 is a front perspective view of the front right-side component for the vehicle door trim set;  
 FIG. 13 is a rear perspective view thereof;  
 FIG. 14 is an exterior side elevation view thereof;  
 FIG. 15 is an enlarged front elevation view thereof; and  
 FIG. 16 is an enlarged rear view thereof.  
 FIG. 17 is a front perspective view of the rear left-side component for the vehicle door trim set;  
 FIG. 18 is a rear perspective view thereof;  
 FIG. 19 is an exterior side elevation view thereof;  
 FIG. 20 is an enlarged rear elevation view thereof;  
 FIG. 21 is an enlarged front elevation view thereof; and  
 FIG. 22 is a top plan view thereof.  
 FIG. 23 is a front perspective view of the rear right-side component for the vehicle door trim set;  
 FIG. 24 is a rear perspective view thereof;  
 FIG. 25 is an exterior side elevation view thereof;  
 FIG. 26 is an enlarged rear elevation view thereof;  
 FIG. 27 is an enlarged front elevation view thereof; and  
 FIG. 28 is a top plan view thereof; and,  
 FIG. 29 is an exterior side view of the vehicle door trim set incorporated into the doors of a motor vehicle.  
 The de-emphasized and halftone portions shown in the drawings illustrate environmental structure for the vehicle door trim set that forms no part of the claimed design.

**1 Claim, 13 Drawing Sheets**

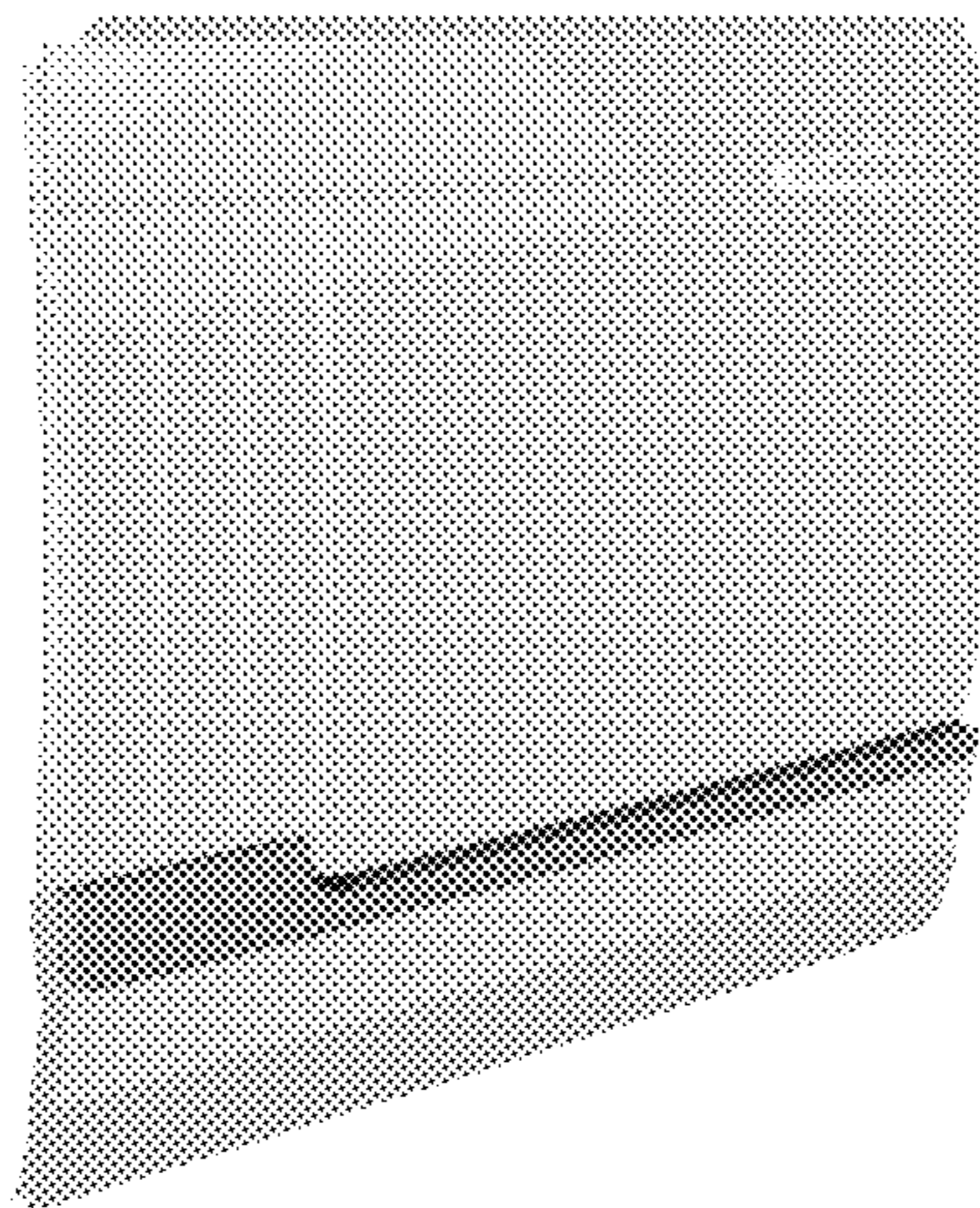

(56)

**References Cited**

U.S. PATENT DOCUMENTS

D413,561 S \* 9/1999 Kulla et al. .... D12/190  
D468,671 S \* 1/2003 Tapi ..... D12/190  
D539,200 S \* 3/2007 Chan ..... D12/190  
D568,220 S \* 5/2008 Okamoto et al. .... D12/196

D599,264 S \* 9/2009 Akasawa et al. .... D12/181  
D608,261 S \* 1/2010 Furuhashi et al. .... D12/190  
D623,104 S \* 9/2010 Akasawa et al. .... D12/190  
D647,018 S \* 10/2011 Furst ..... D12/190  
2007/0085361 A1 \* 4/2007 Hauser ..... 296/1.08  
2012/0169024 A1 \* 7/2012 Verhee et al. .... 280/166

\* cited by examiner

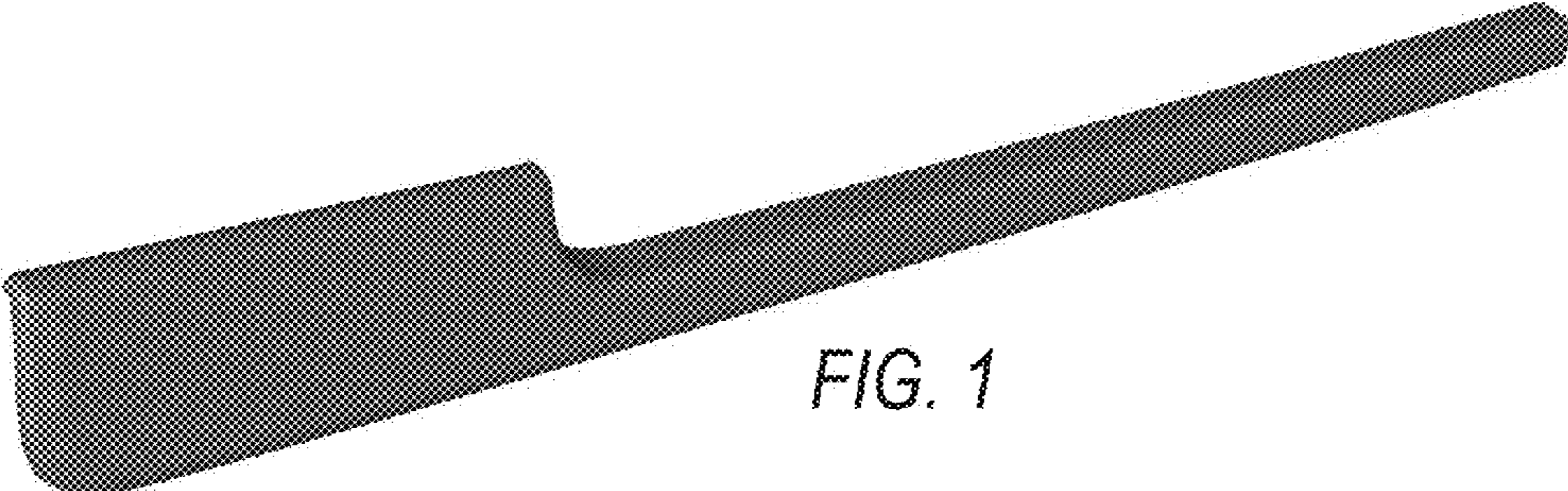

FIG. 1

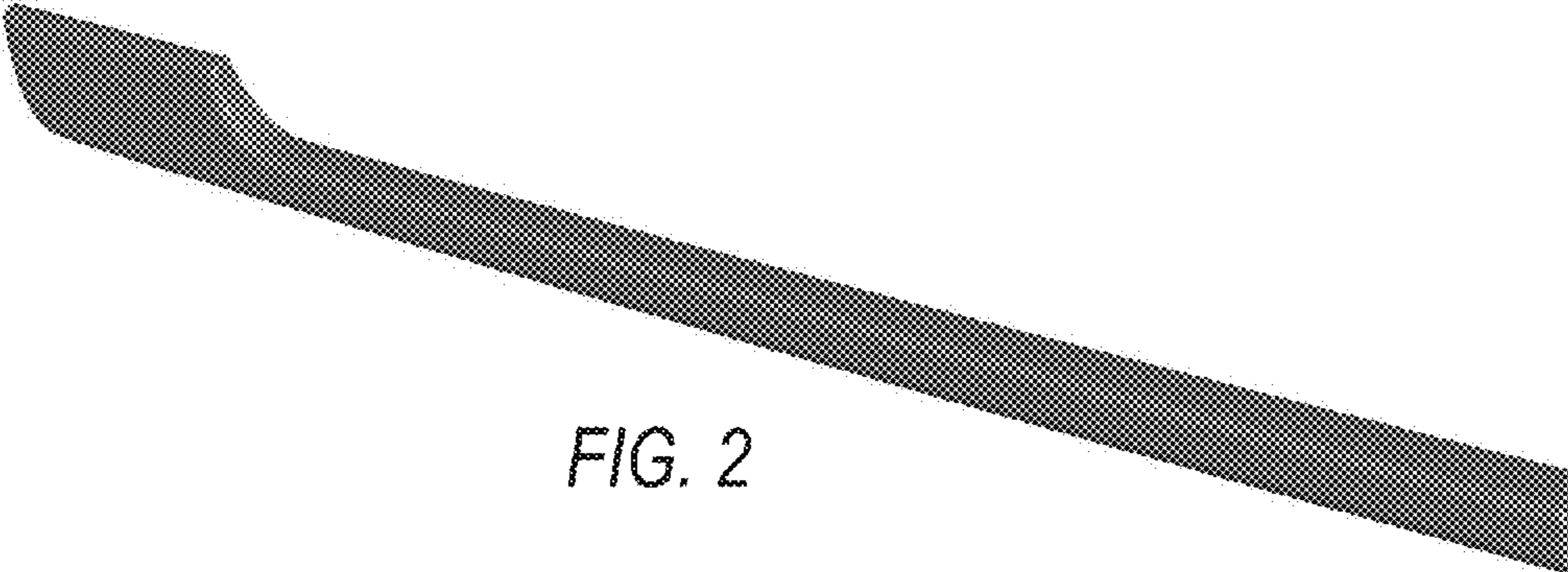

FIG. 2

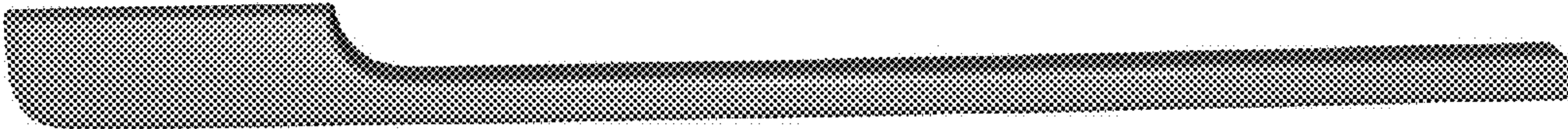

FIG. 3

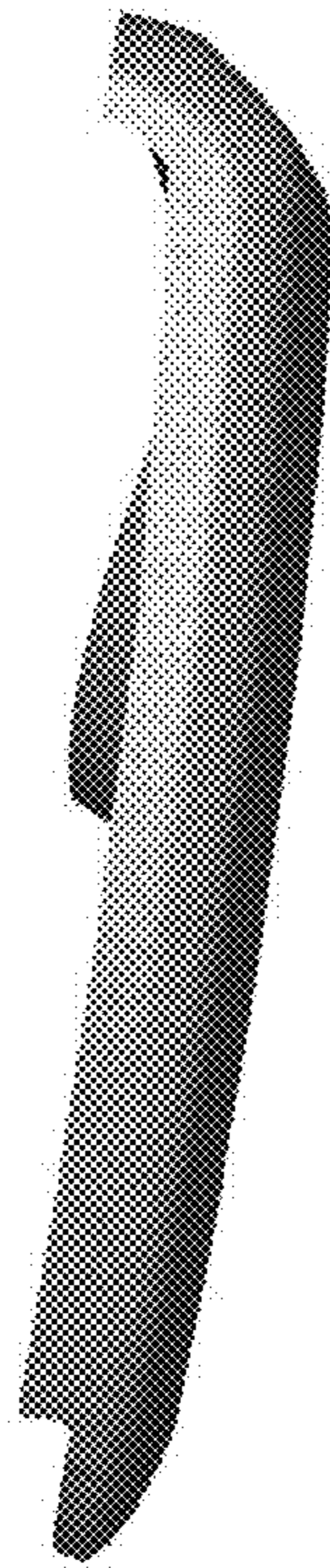

FIG. 4

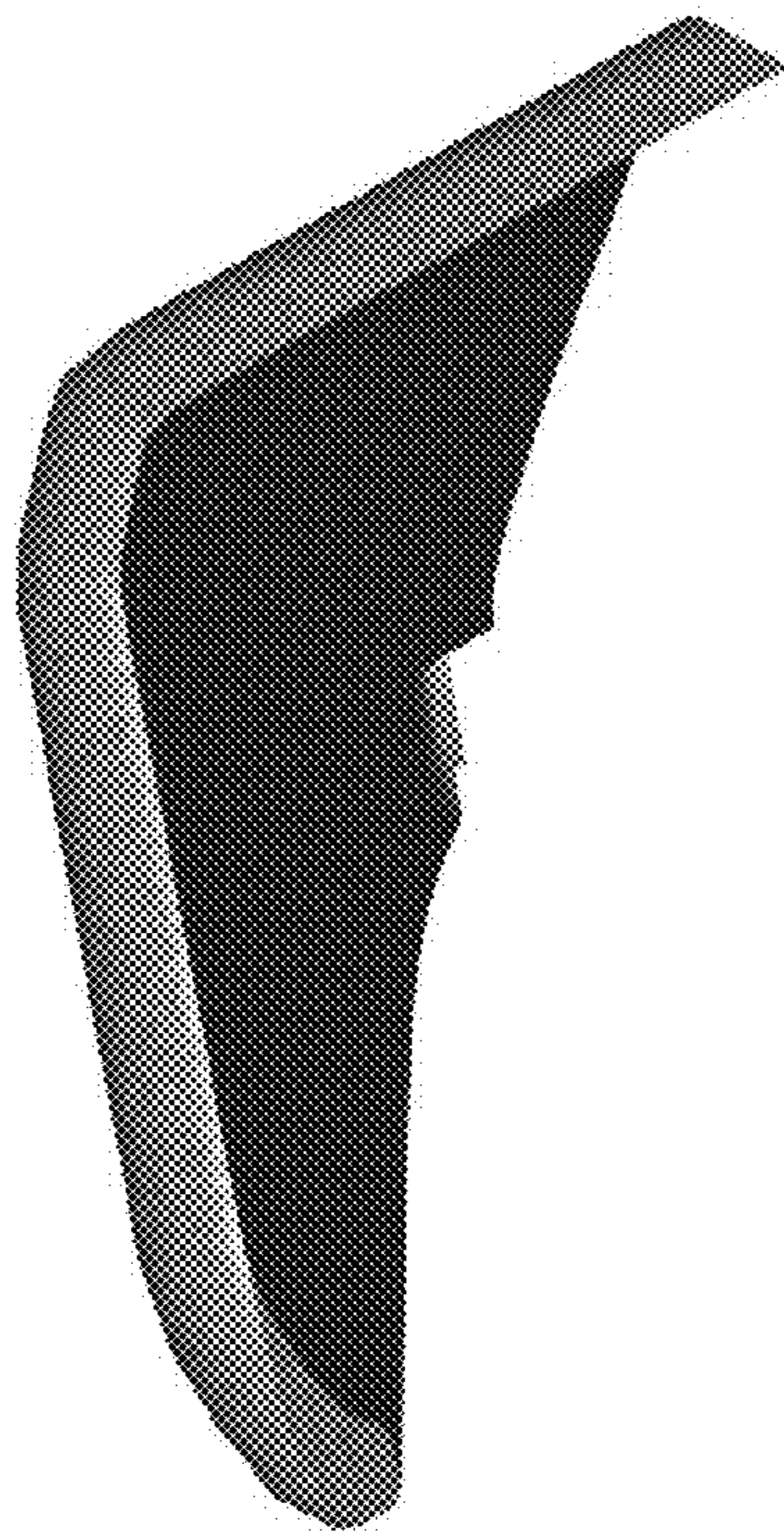

FIG. 5



FIG. 6

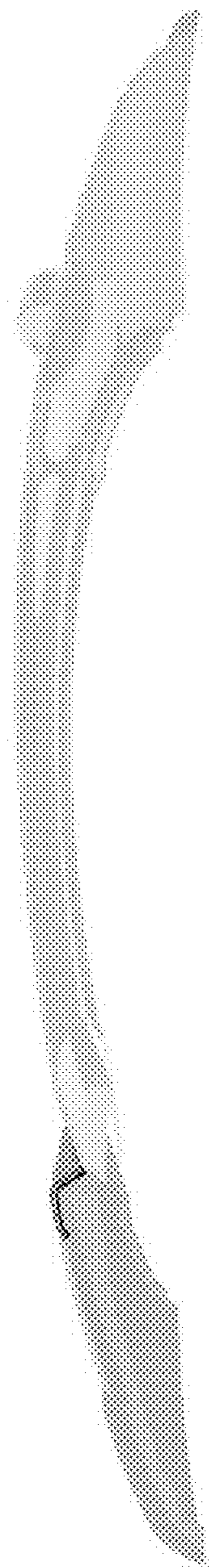

FIG. 7

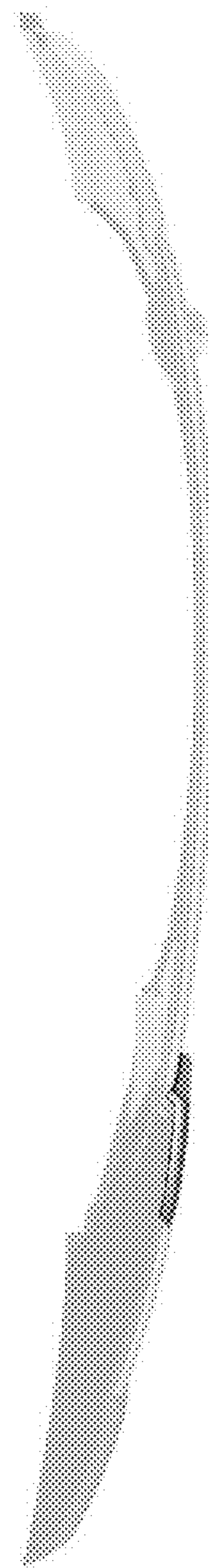

FIG. 8



FIG. 9

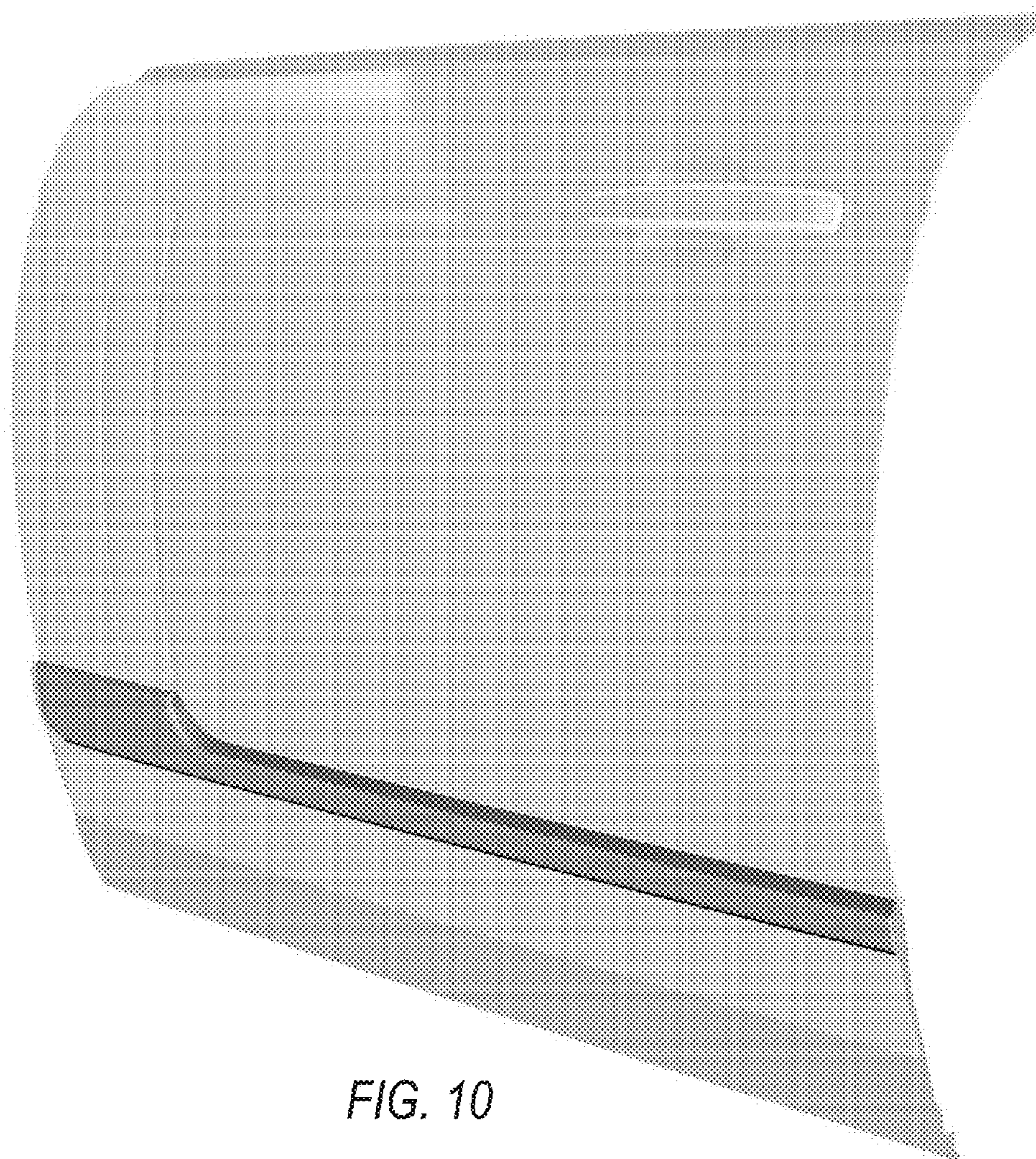

FIG. 10

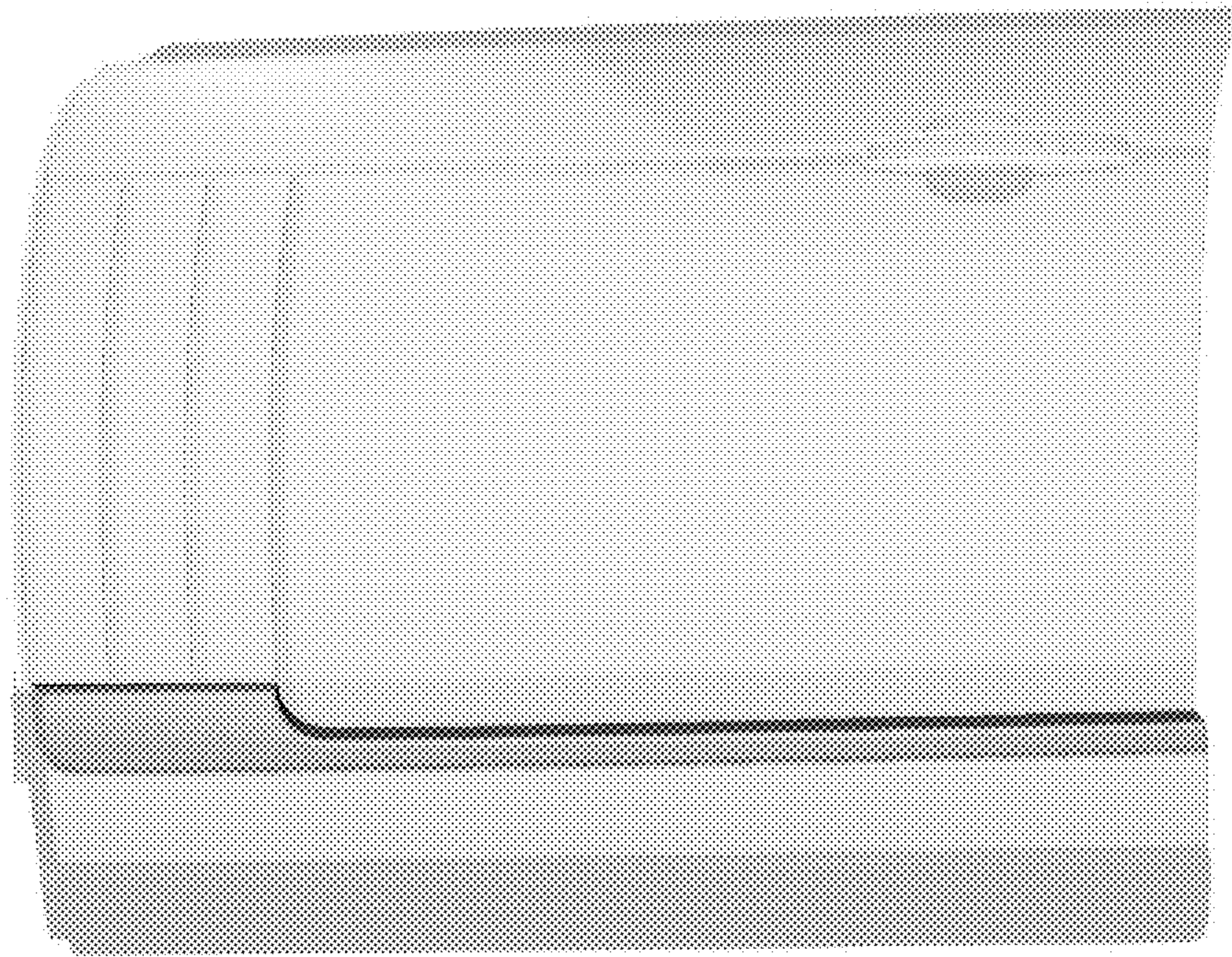

FIG. 11



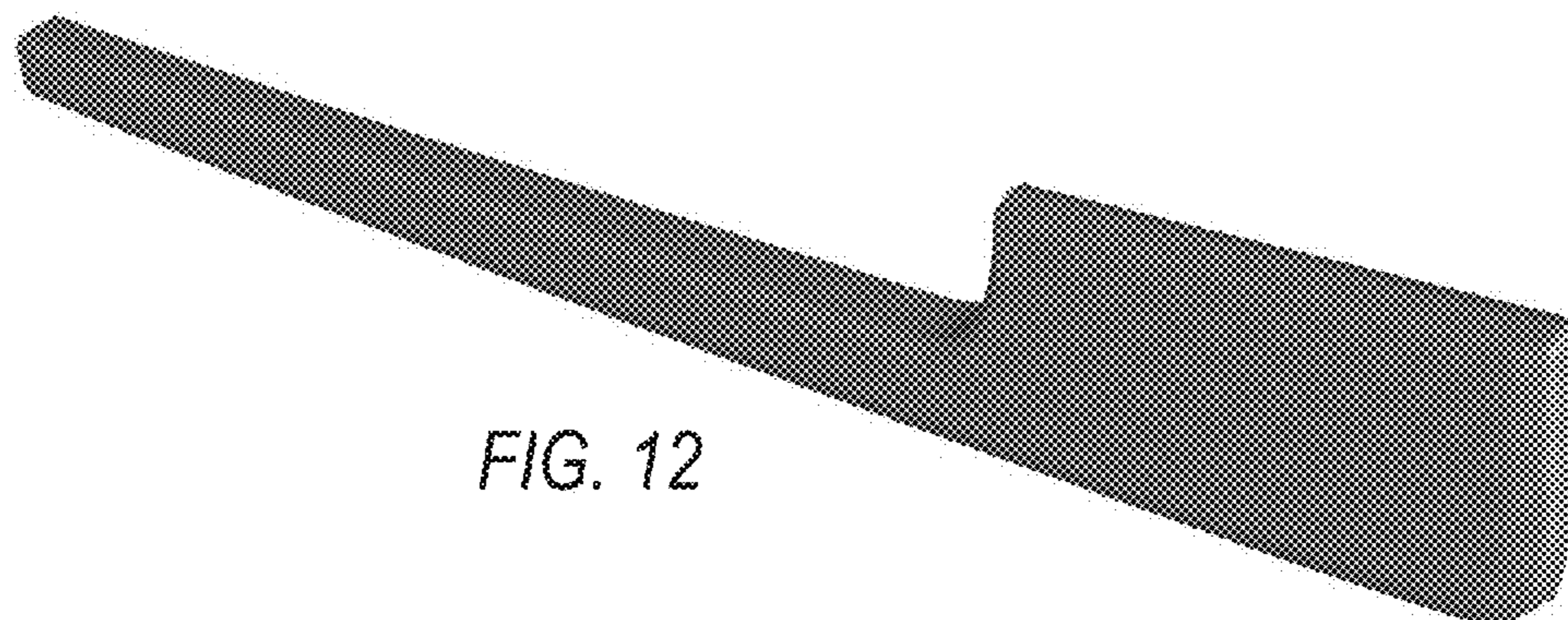

FIG. 12

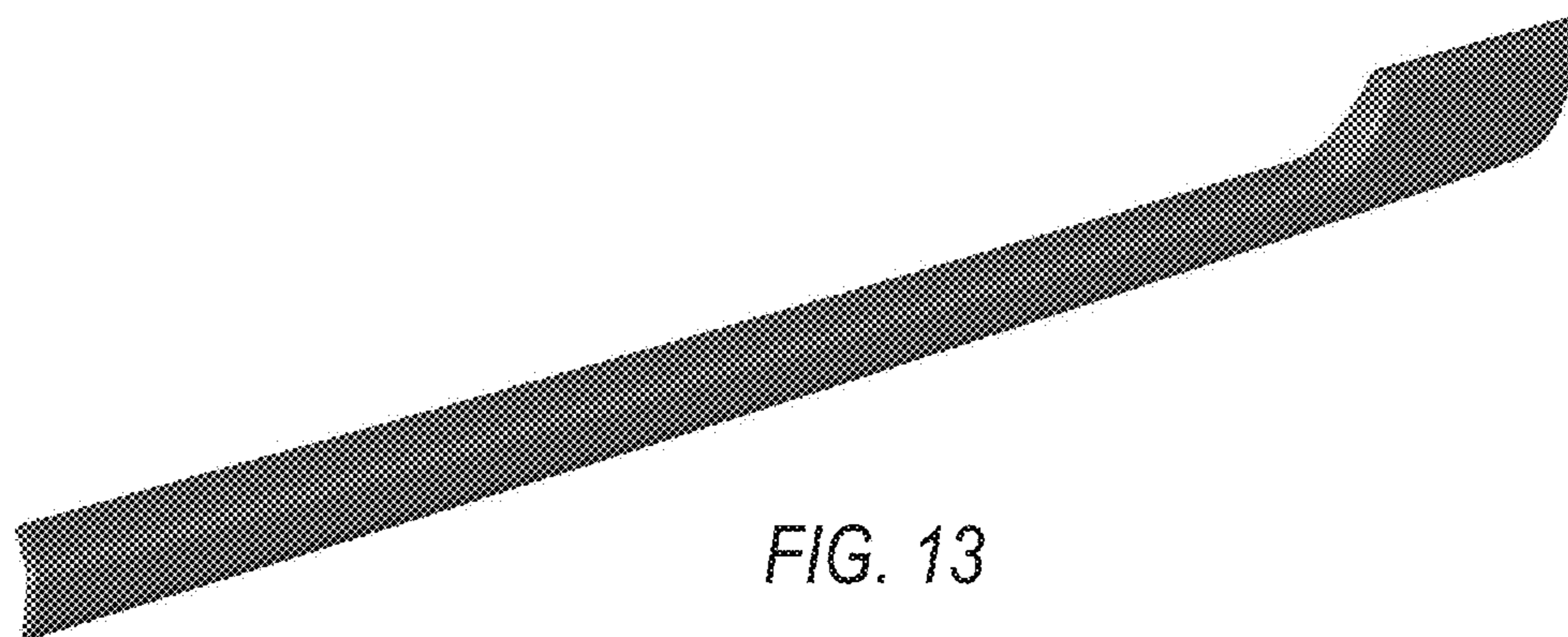

FIG. 13



FIG. 14

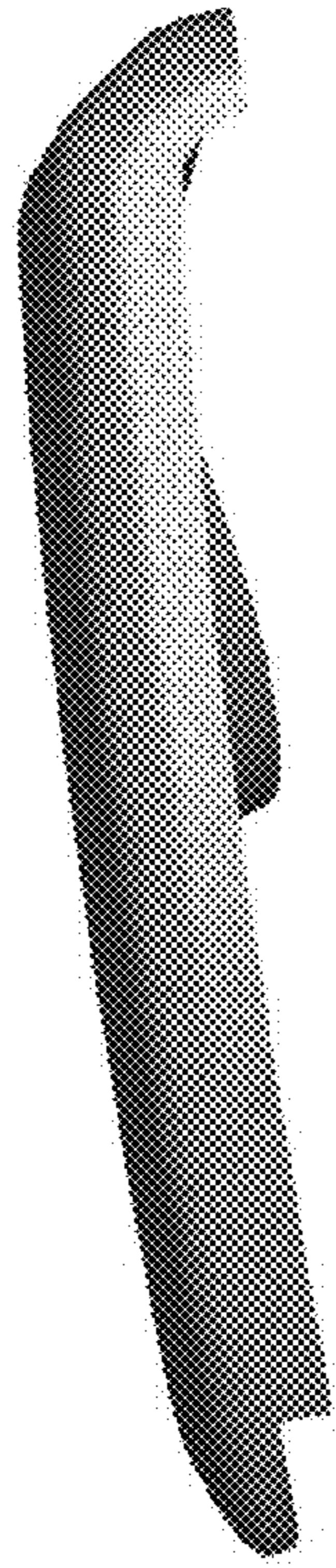

FIG. 15

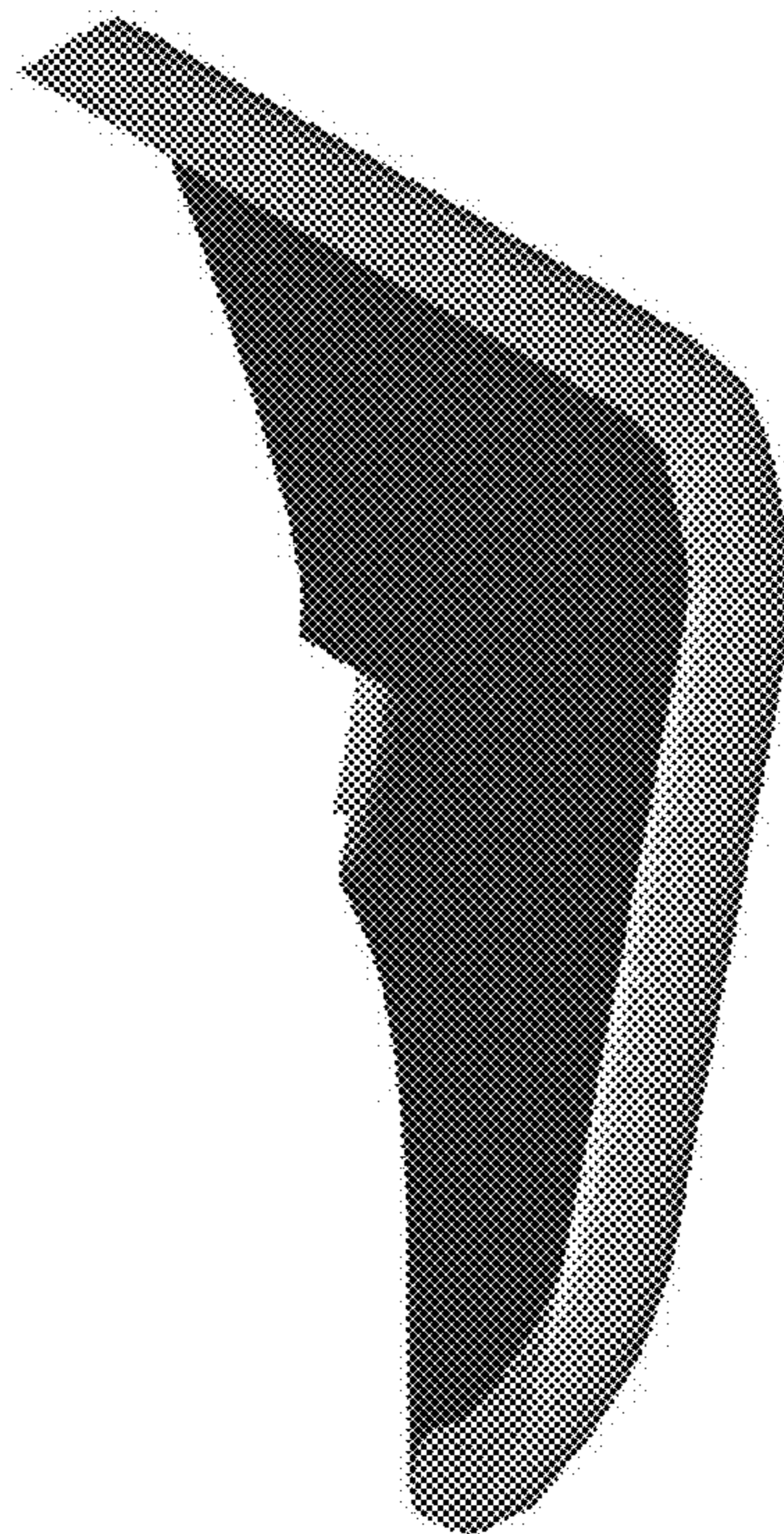

FIG. 16

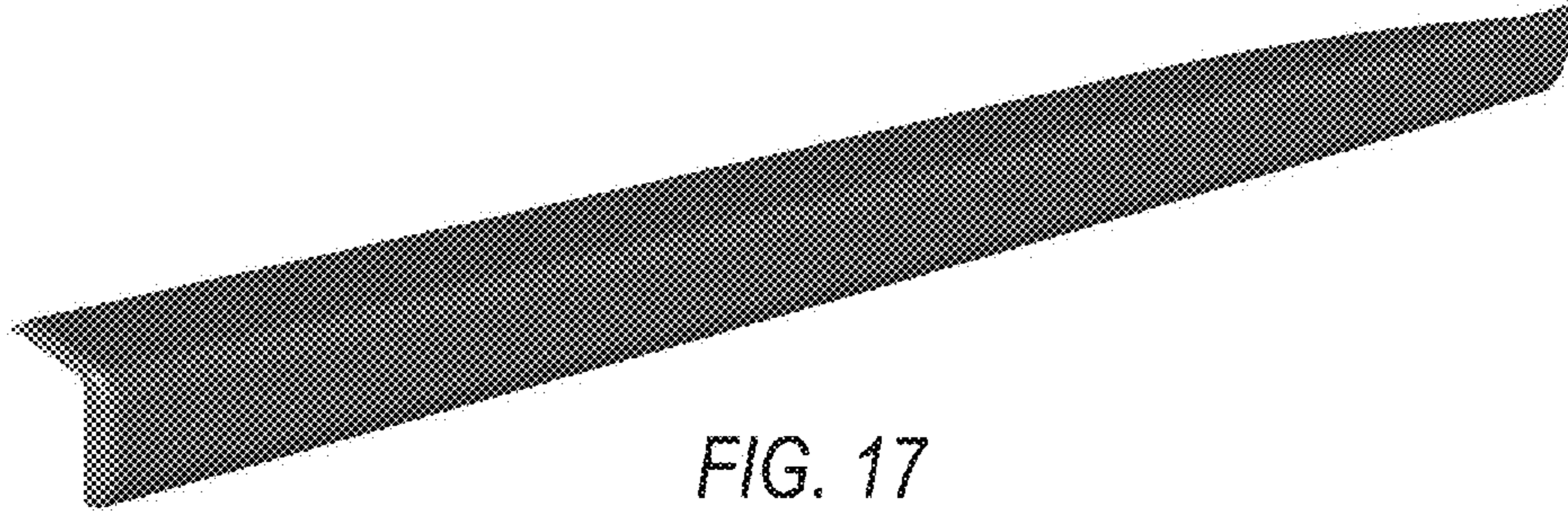

FIG. 17

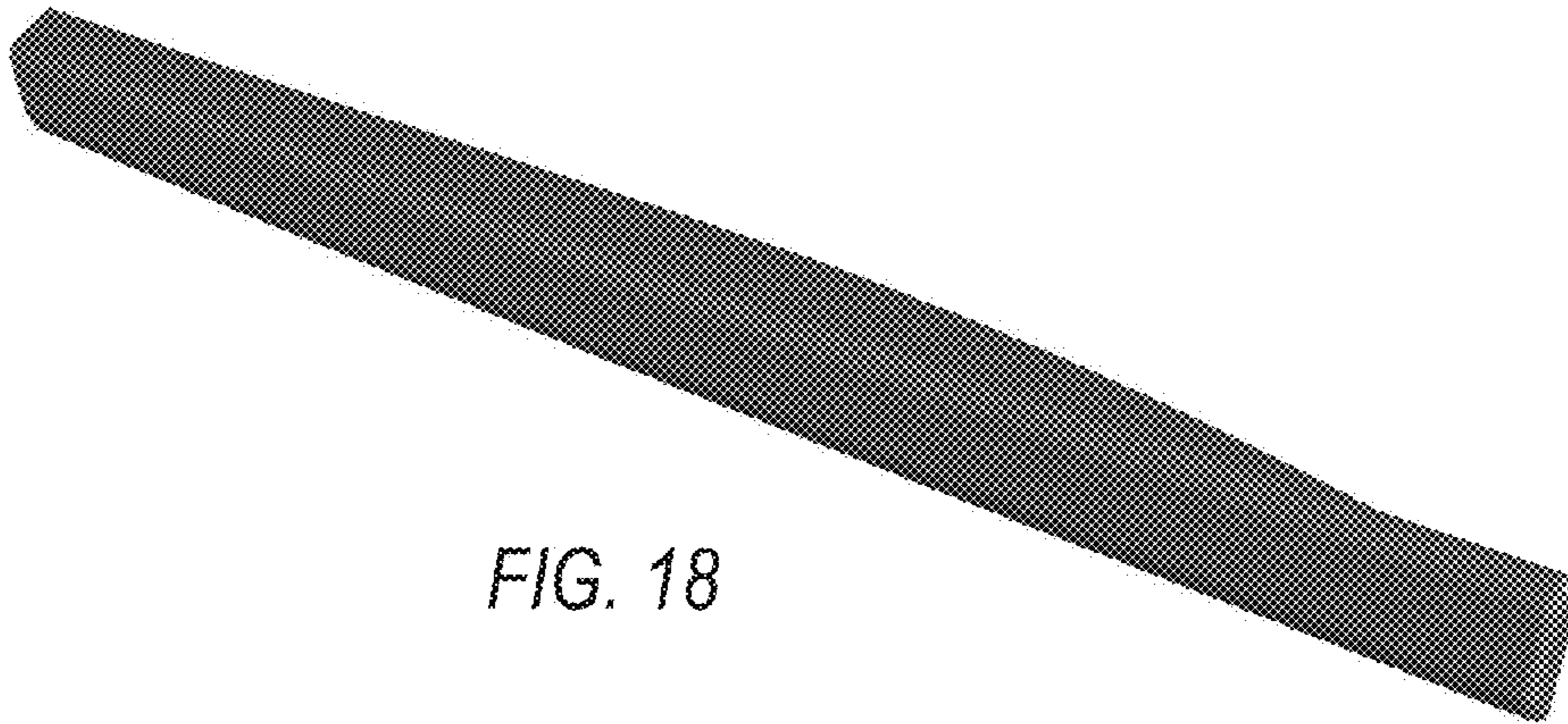

FIG. 18

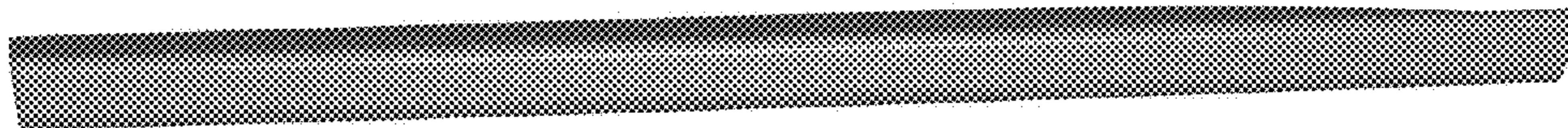

FIG. 19

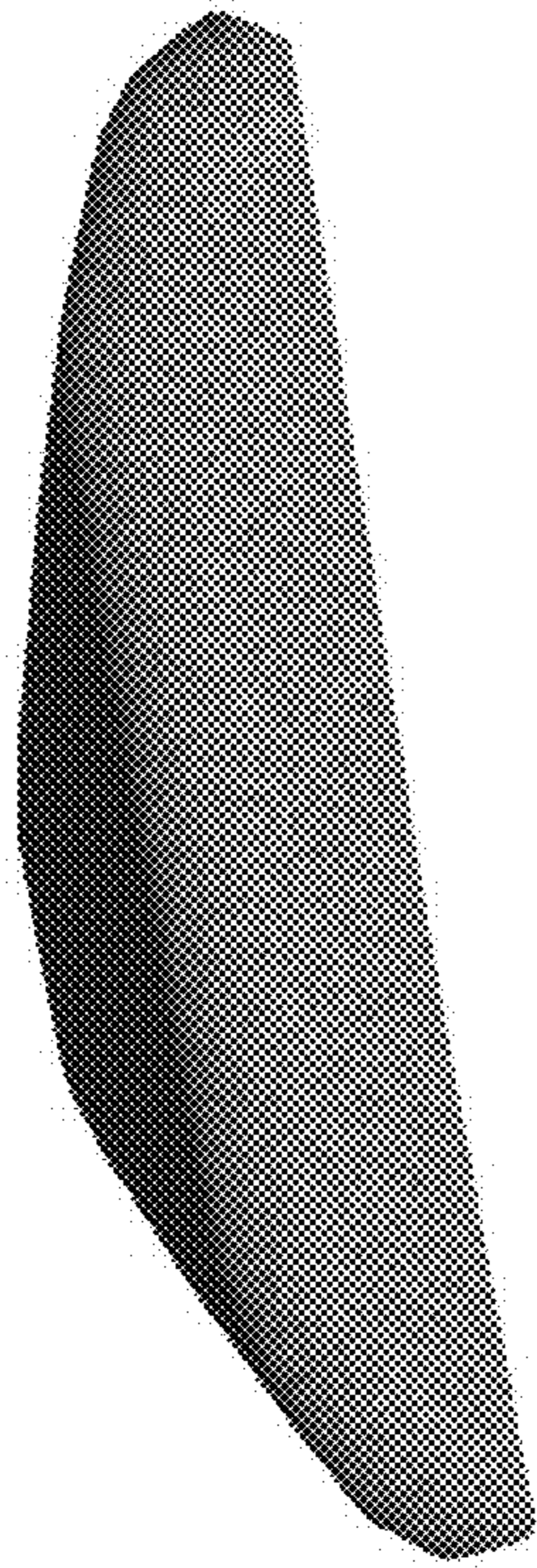

FIG. 20

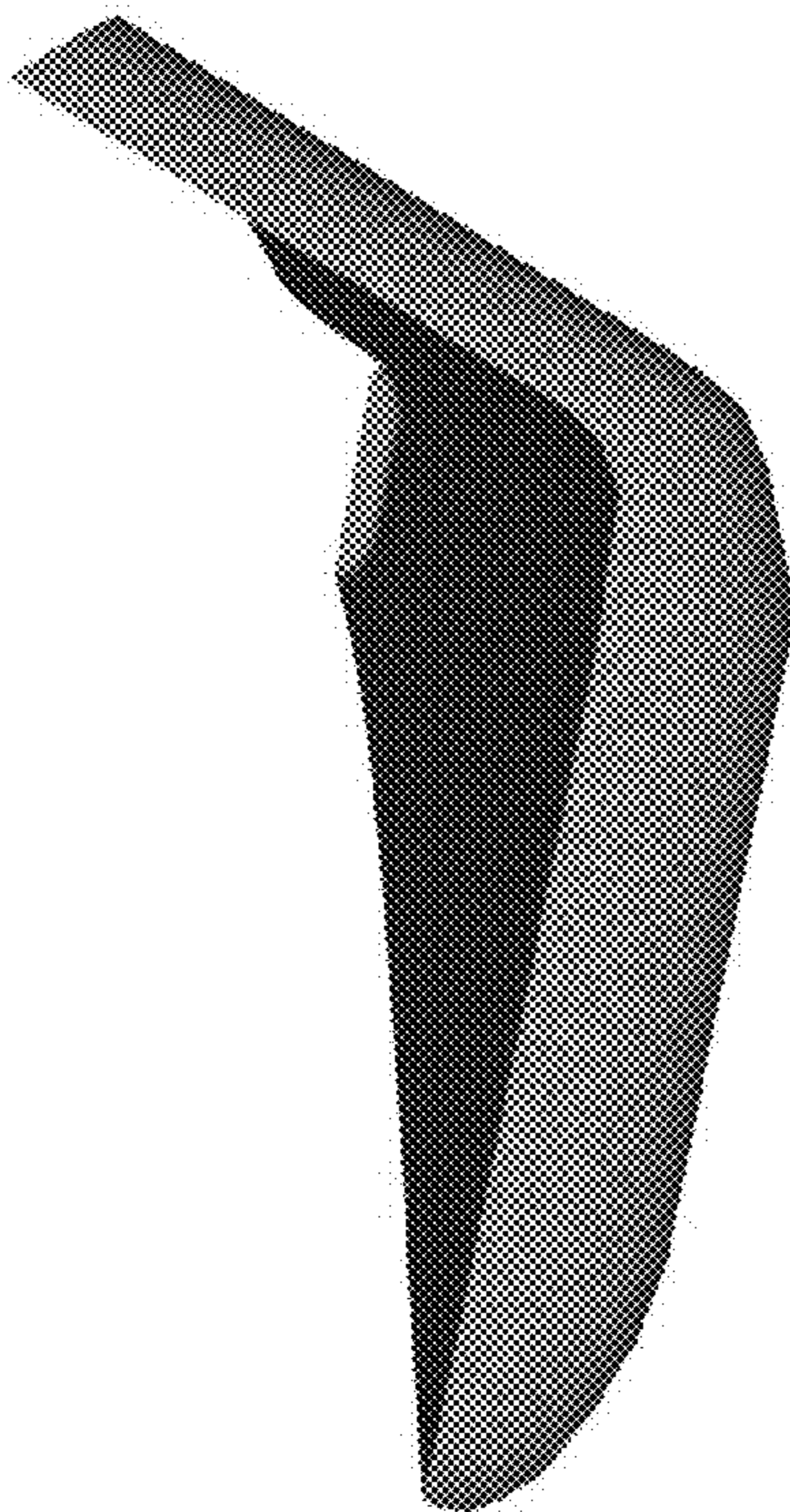

FIG. 21



FIG. 22

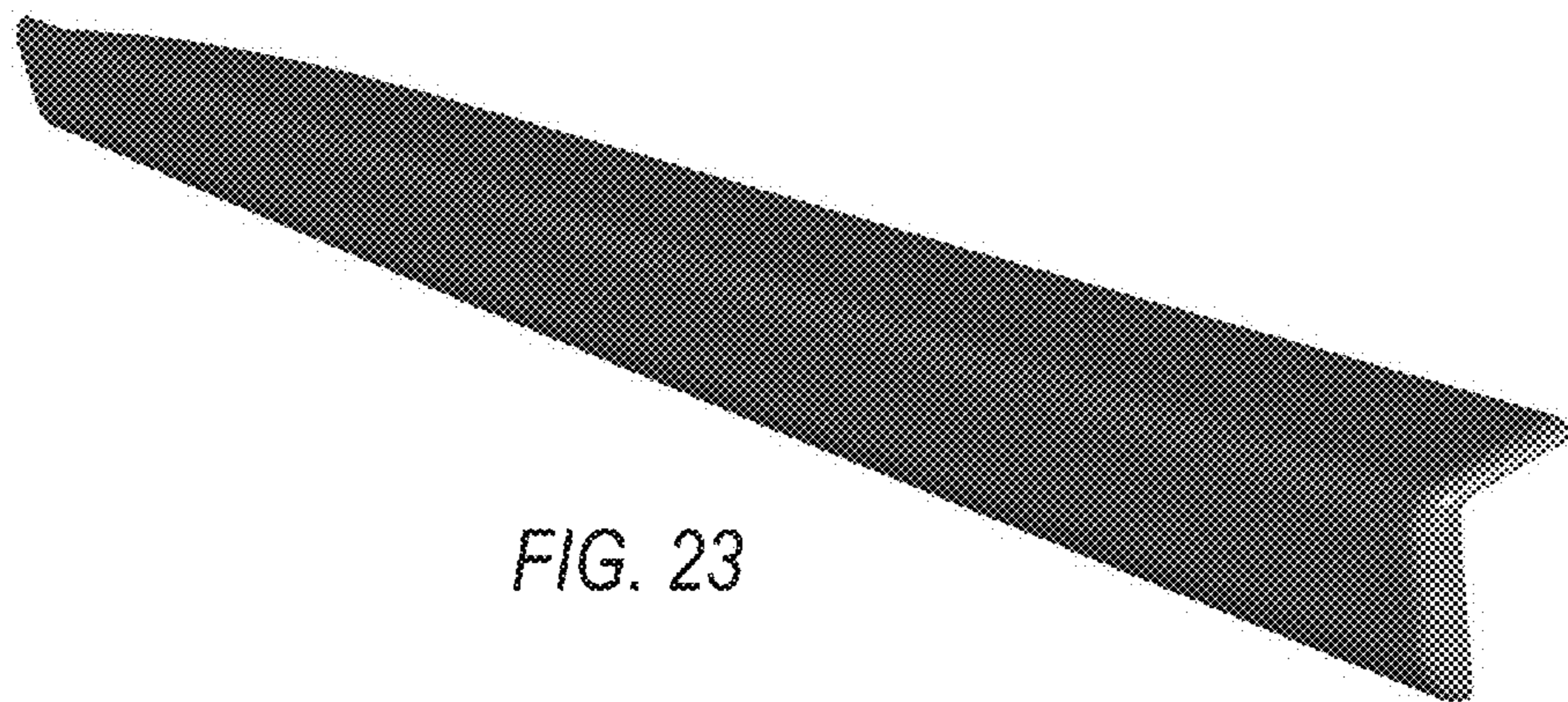

FIG. 23

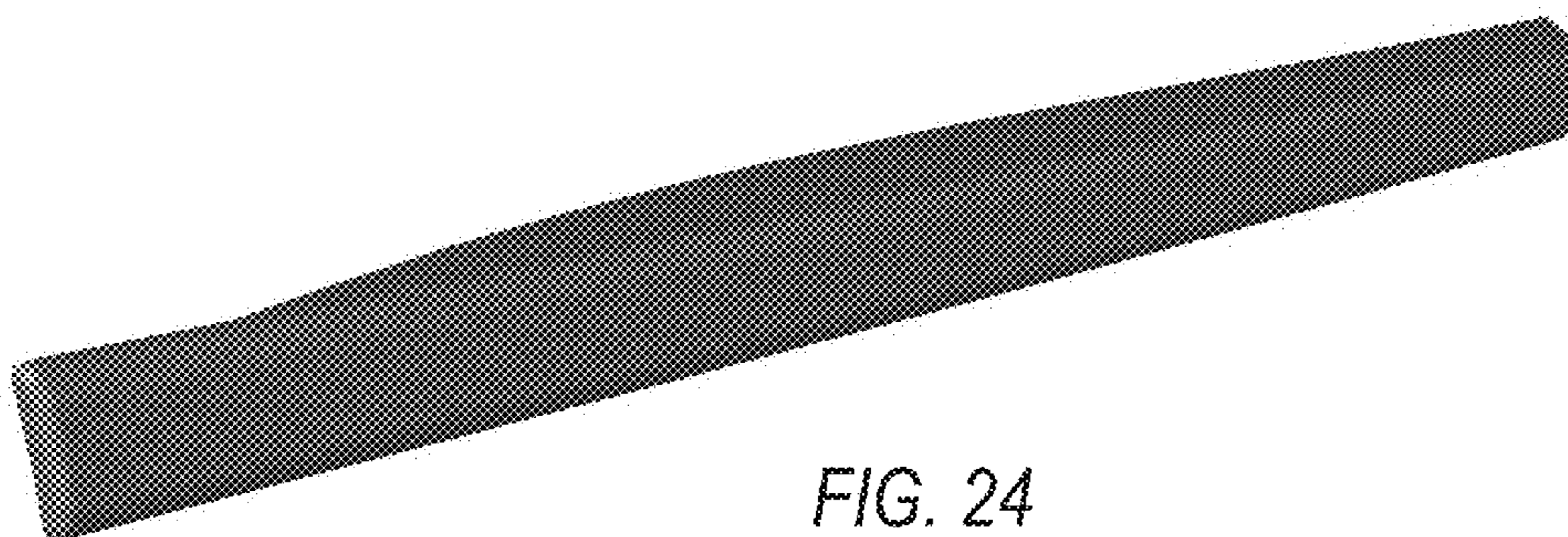

FIG. 24

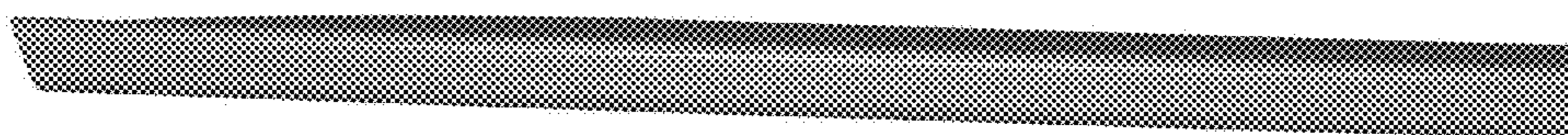

FIG. 25

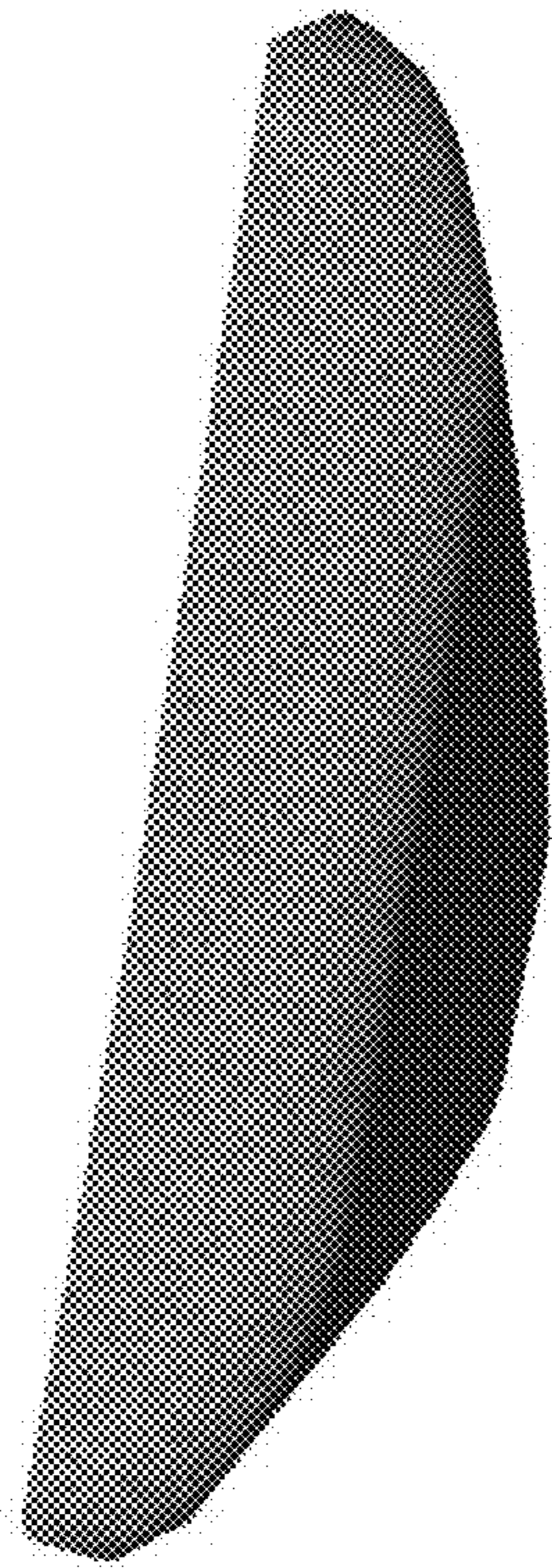

FIG. 26

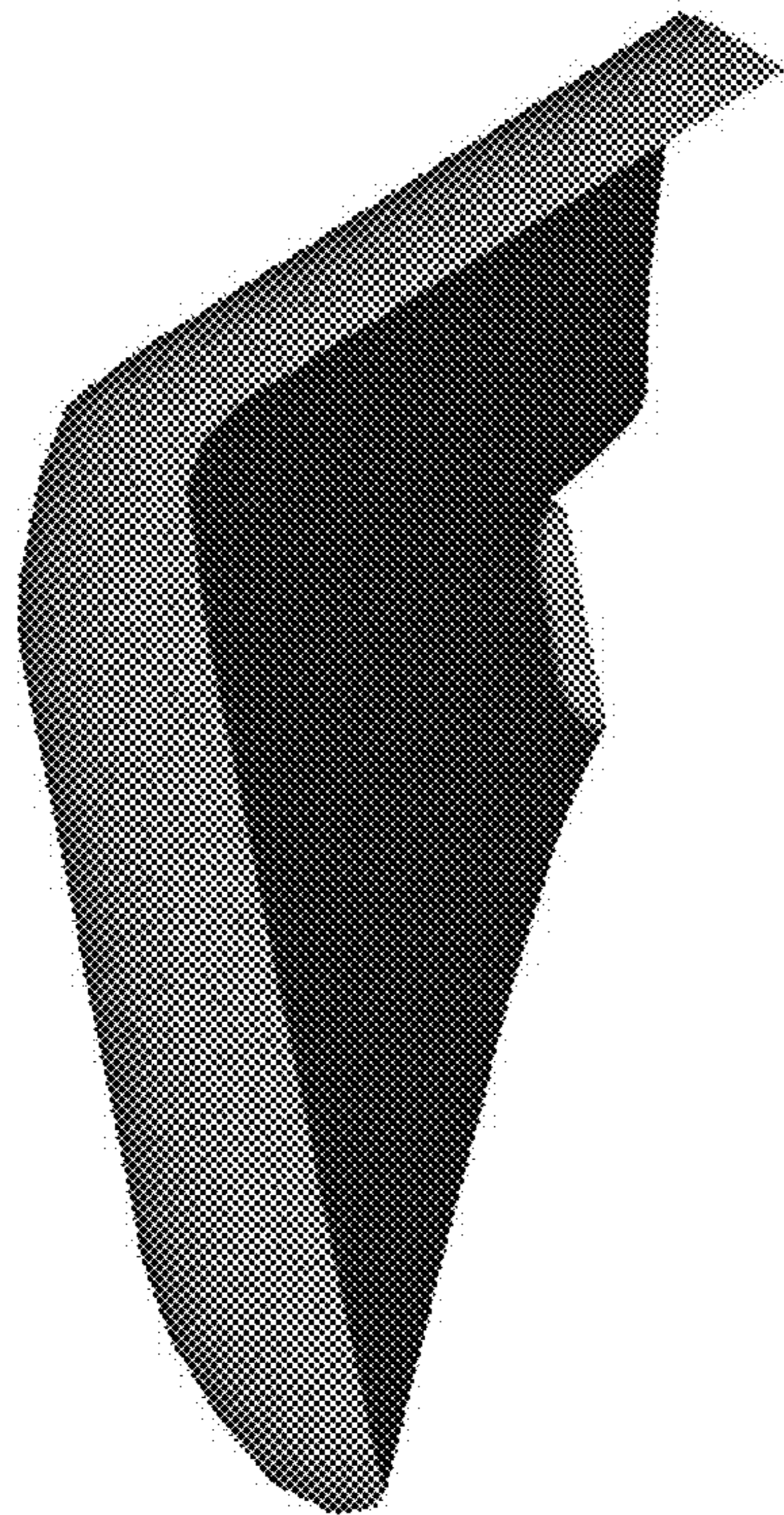

FIG. 27

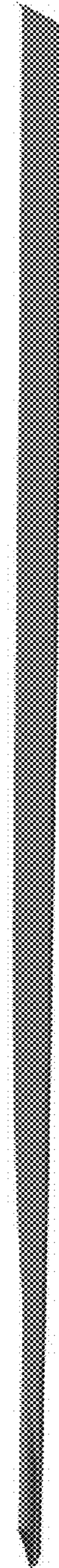

FIG. 28

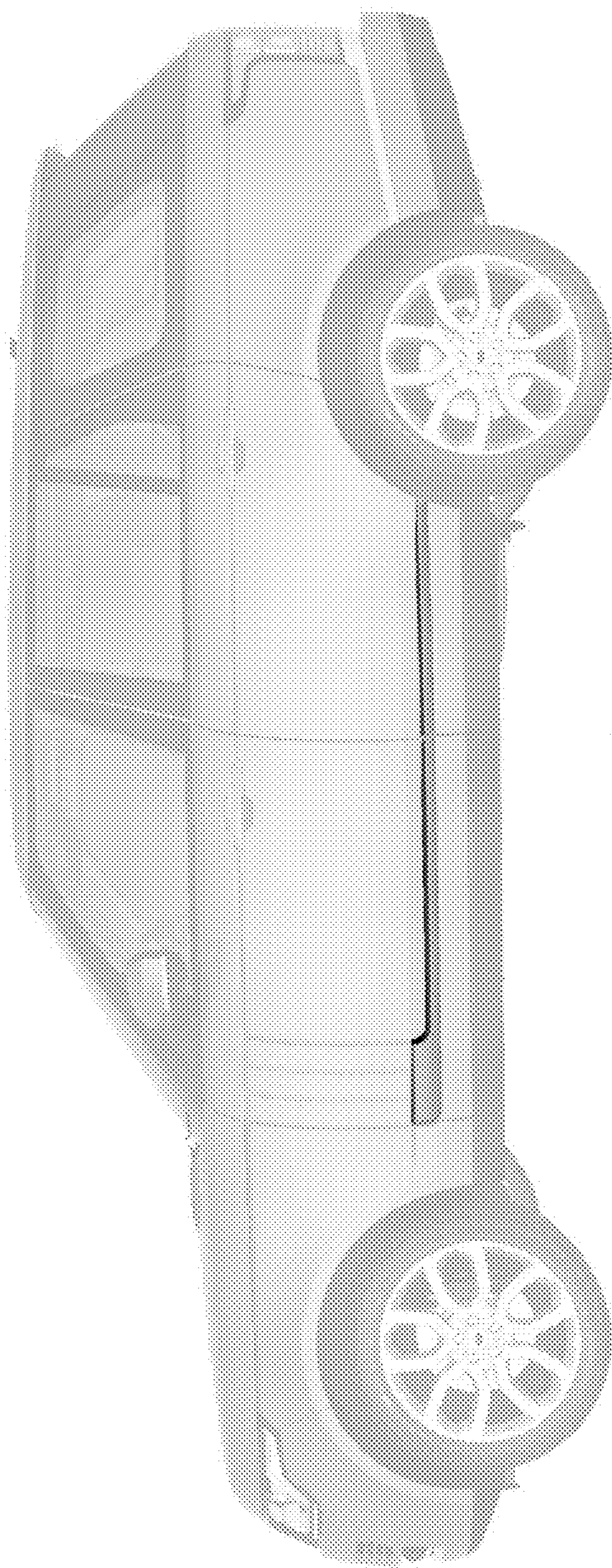

FIG. 29