



US00D709405S

(12) **United States Design Patent**
Keyaki et al.

(10) **Patent No.:** **US D709,405 S**
(45) **Date of Patent:** **** Jul. 22, 2014**

(54) **SLIDER FOR SLIDE FASTENER**

(56) **References Cited**

(71) Applicant: **YKK Corporation**, Tokyo (JP)

U.S. PATENT DOCUMENTS

(72) Inventors: **Keiichi Keyaki**, Toyama (JP); **Shinya Honda**, Toyama (JP)

D291,669	S	*	9/1987	Oda	D11/221
D390,811	S	*	2/1998	Yaguramaki	D11/221
D467,523	S	*	12/2002	Lin	D11/221
6,536,084	B2	*	3/2003	Davis	24/415
D527,311	S	*	8/2006	Yamagishi et al.	D11/221
D555,538	S	*	11/2007	Lin	D11/221
D556,087	S	*	11/2007	Lin	D11/221
7,533,451	B2	*	5/2009	Akashi et al.	24/386

(73) Assignee: **YKK Corporation** (JP)

(**) Term: **14 Years**

* cited by examiner

(21) Appl. No.: **29/476,527**

Primary Examiner — Ralf Seifert

(22) Filed: **Dec. 13, 2013**

(74) *Attorney, Agent, or Firm* — Kilpatrick Townsend & Stockton LLP

(30) **Foreign Application Priority Data**

(57) **CLAIM**

The ornamental design for a slider for slide fastener, as shown and described.

Jun. 18, 2013 (JP) 2013-013695

DESCRIPTION

(51) **LOC (10) Cl.** **02-07**

FIG. 1 is a first perspective view of the front, bottom and right side of a slider for slide fastener showing my new design; FIG. 2 is a second perspective view of the rear, top and left side thereof; FIG. 3 is a front view thereof; FIG. 4 is a rear view thereof; FIG. 5 is a right side view thereof, the left side view being mirror image thereof; FIG. 6 is a top plan view thereof; and, FIG. 7 is a bottom view thereof.

(52) **U.S. Cl.**

USPC **D11/221**

(58) **Field of Classification Search**

CPC A44B 19/00; A44B 19/02; A44B 19/04; A44B 19/10; A44B 19/24; A44B 19/26; A44B 19/30

USPC D11/200, 201, 221, 86, 87; 24/381–383, 385–387, 414–417, 24/421–422, 427–431, 433, 424; 2/265; D2/641, 642; 294/3.6; 223/118

See application file for complete search history.

1 Claim, 6 Drawing Sheets

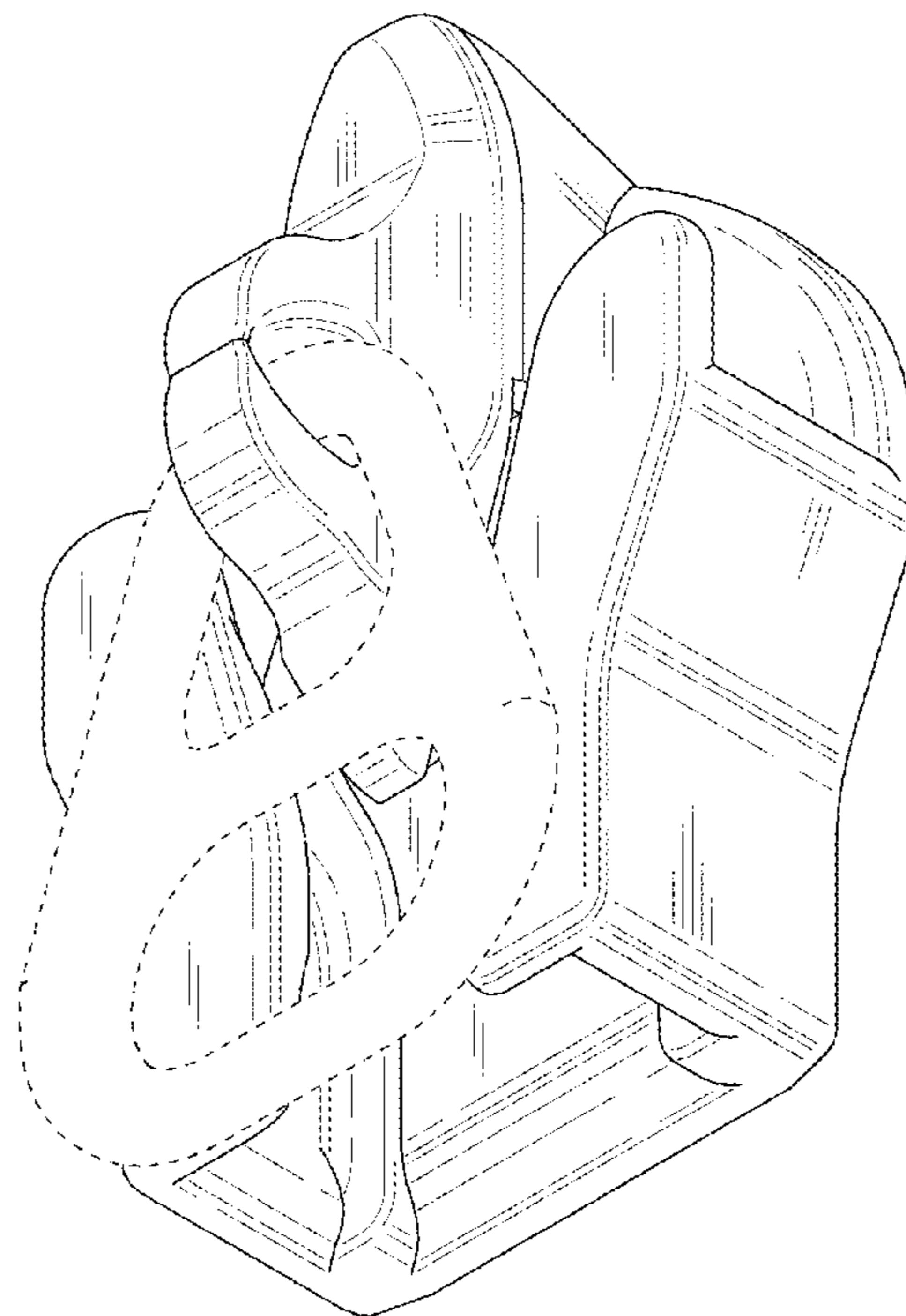

Fig. 1

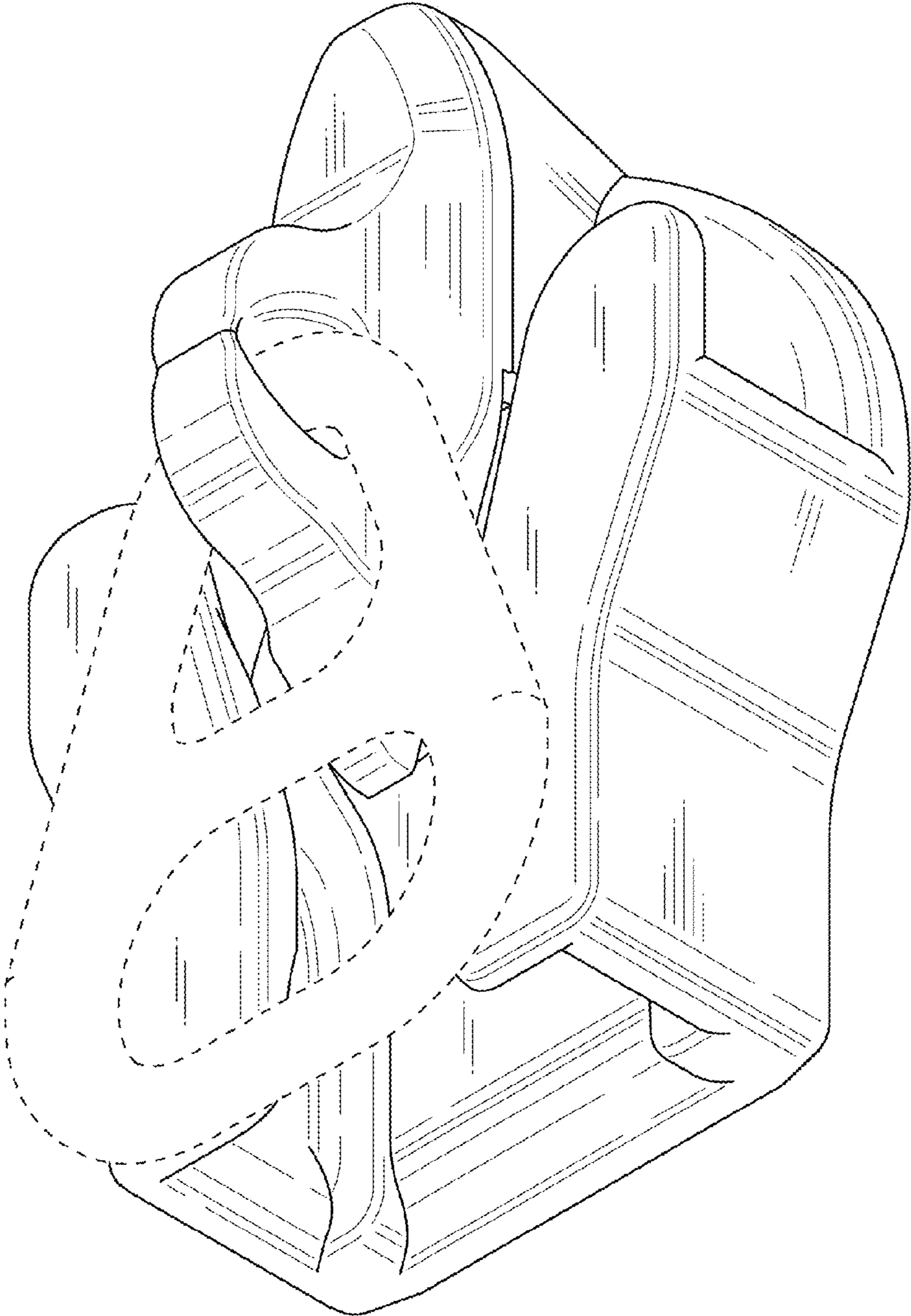

Fig. 2

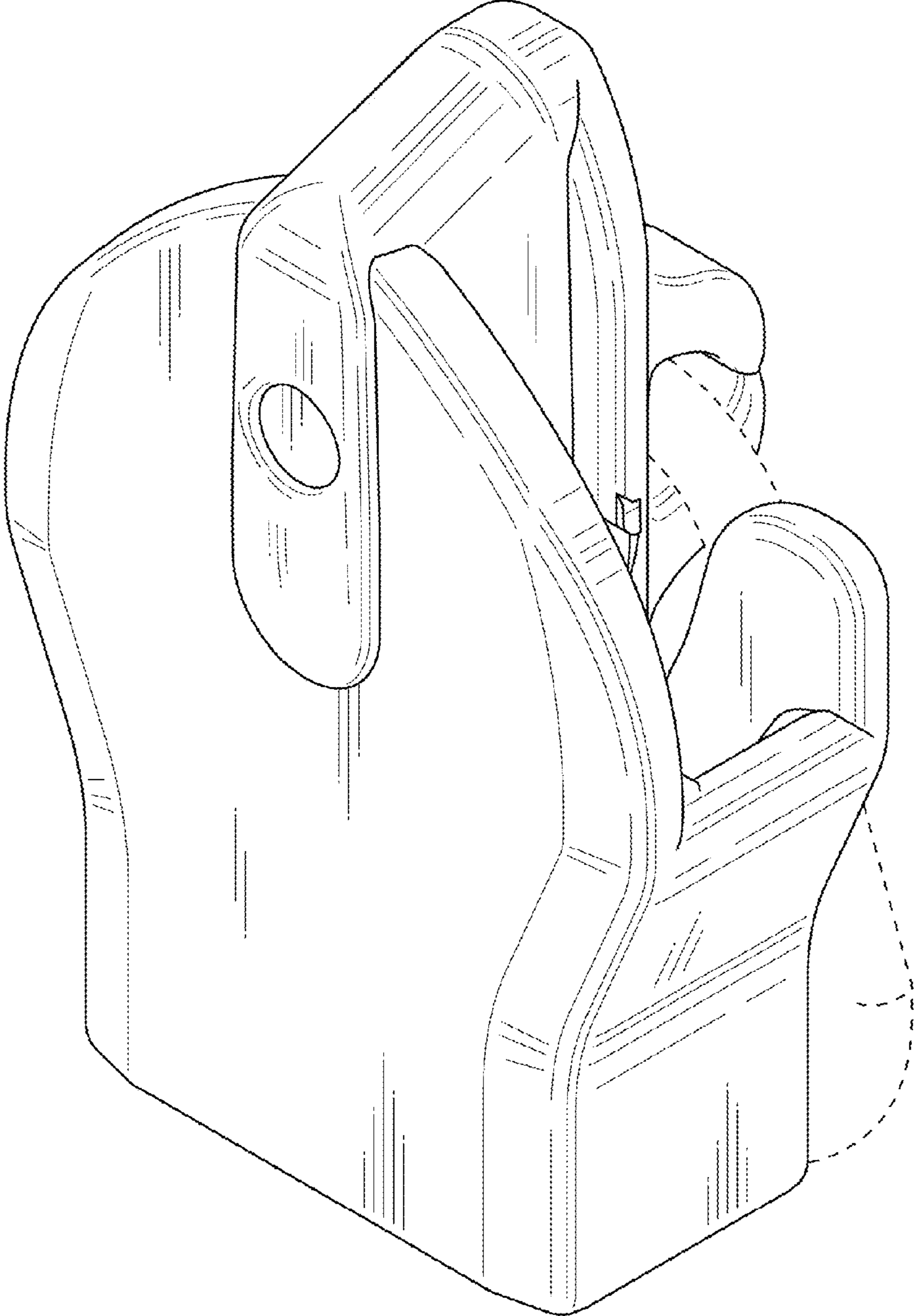

Fig. 3

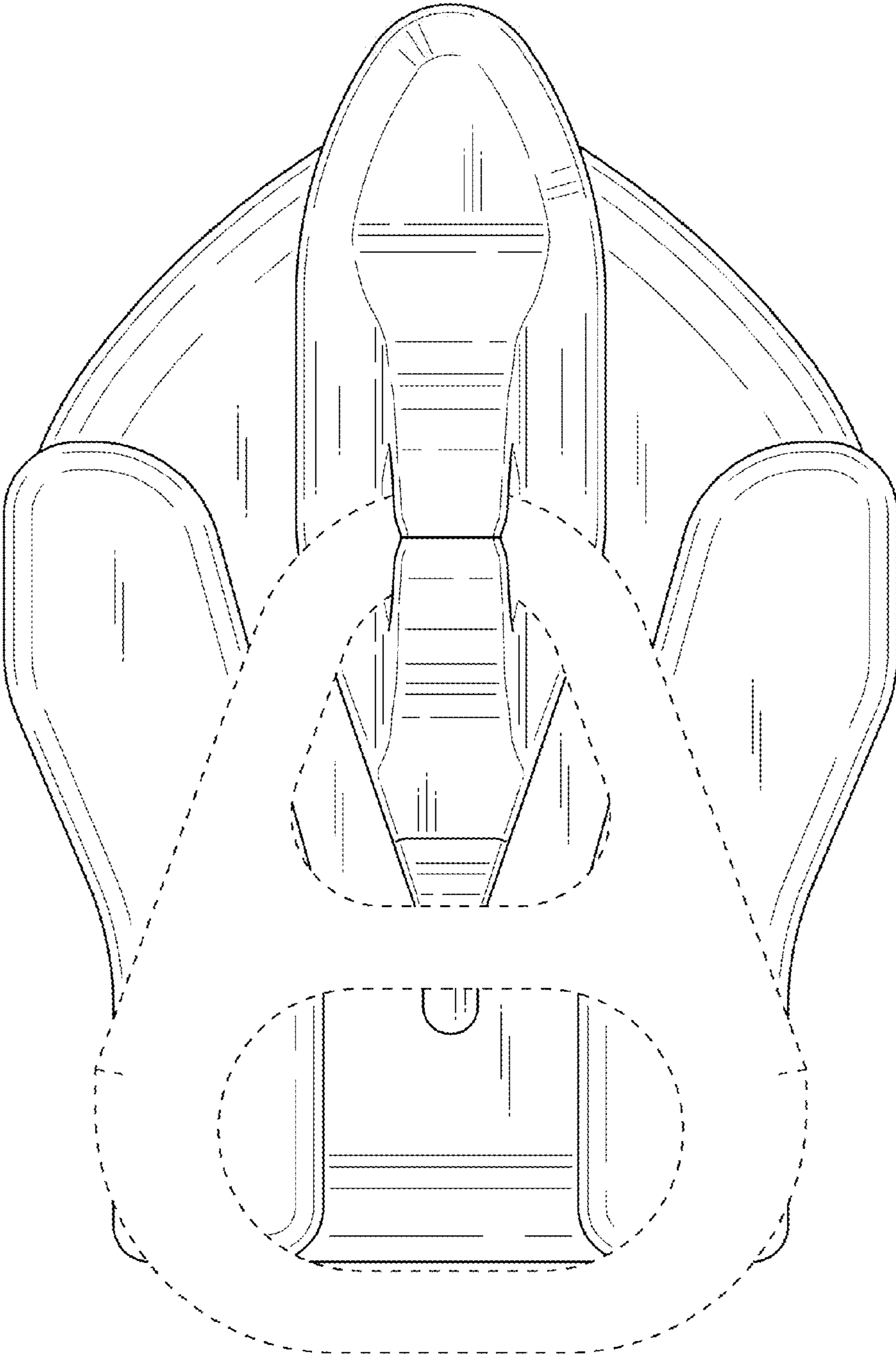

Fig. 4

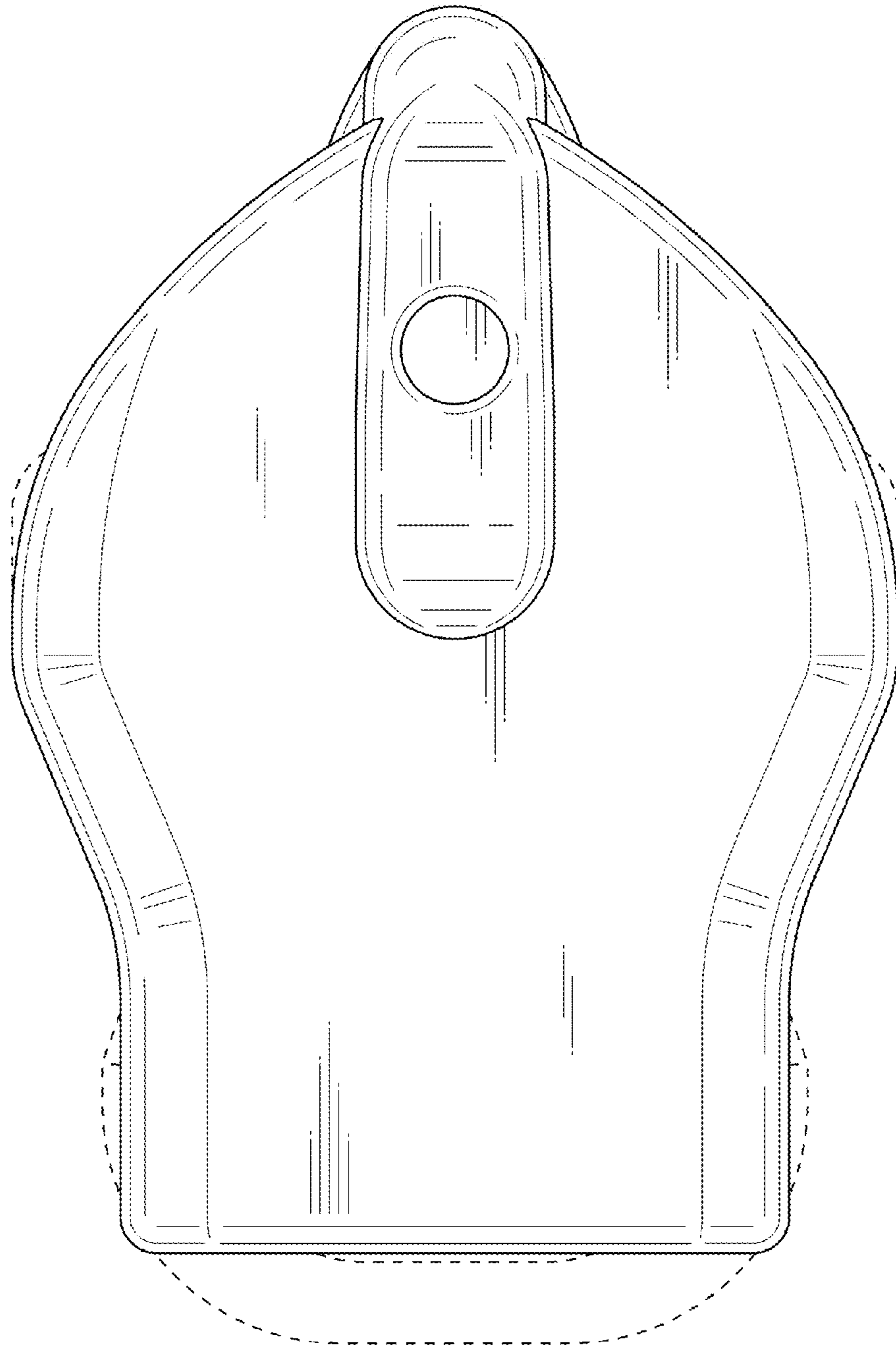

Fig. 5

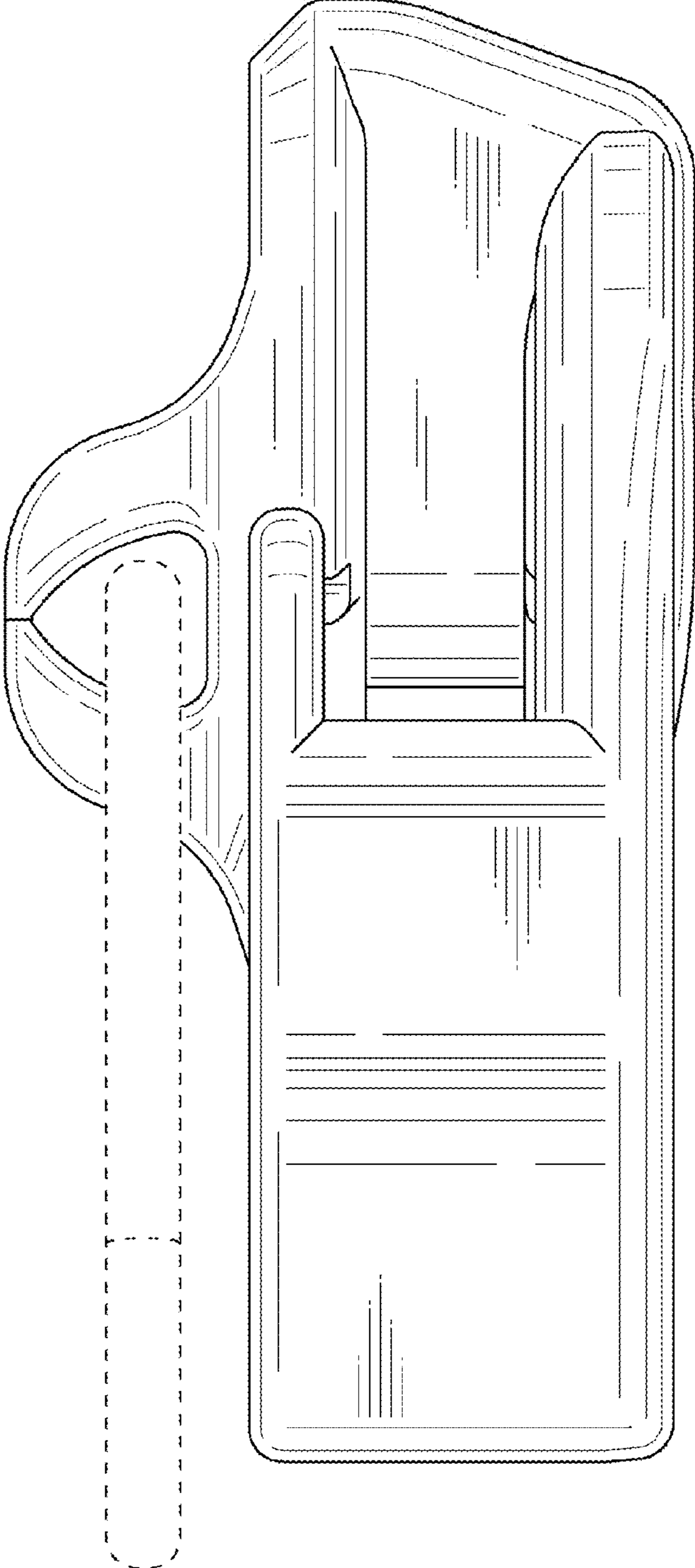

Fig. 6

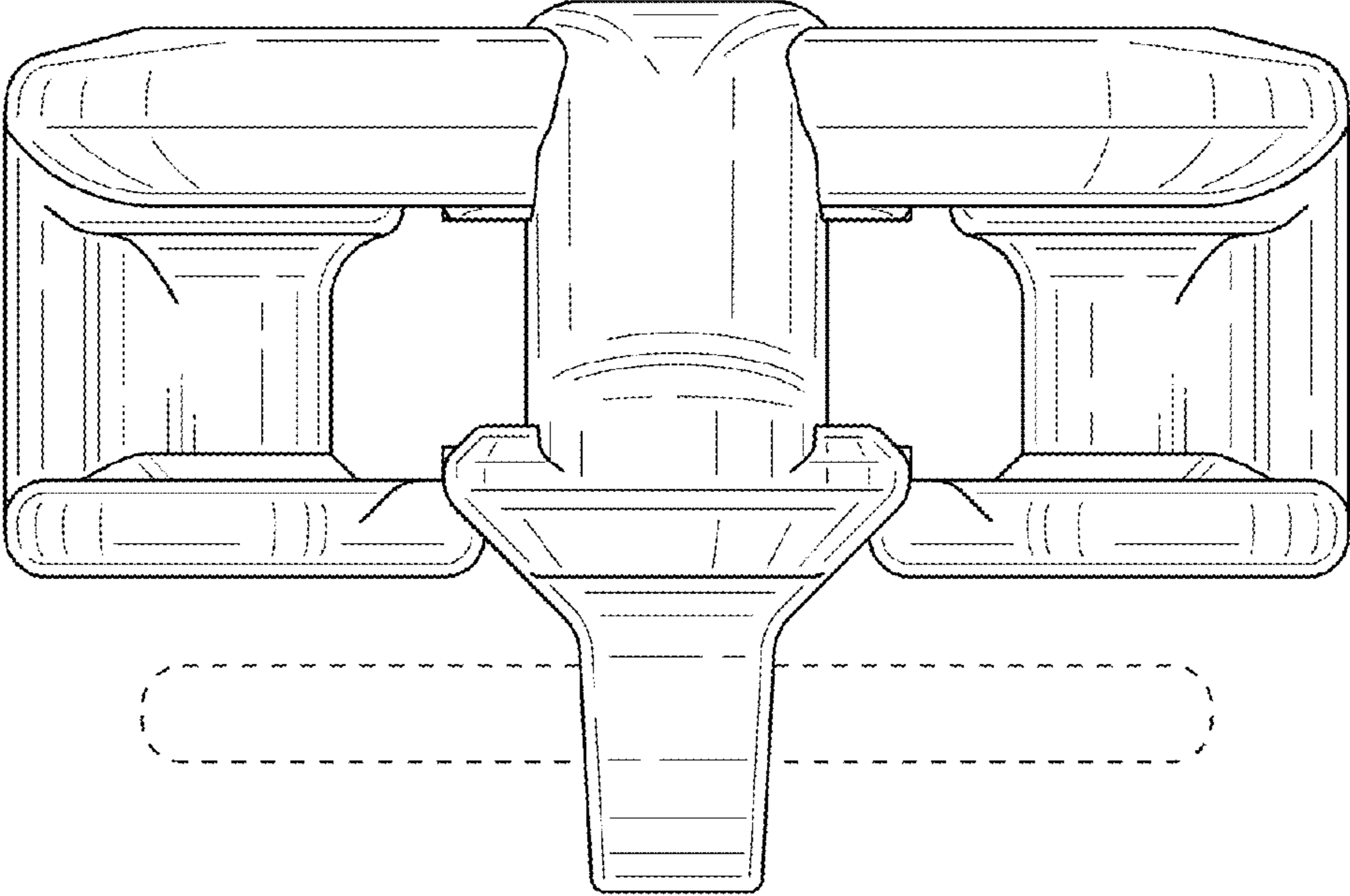

Fig. 7

