



US00D709346S

(12) **United States Design Patent**
Liu

(10) **Patent No.:** **US D709,346 S**

(45) **Date of Patent:** **** Jul. 22, 2014**

(54) **HANDLE OF HAND TOOLS**

(71) Applicant: **Tsai-Fa Liu**, Taichung (TW)

(72) Inventor: **Tsai-Fa Liu**, Taichung (TW)

(**) Term: **14 Years**

(21) Appl. No.: **29/456,747**

(22) Filed: **Jun. 4, 2013**

(51) **LOC (10) Cl.** **08-06**

(52) **U.S. Cl.**
USPC **D8/107**

(58) **Field of Classification Search**
CPC B25G 1/10
USPC D8/107, 82, 83, 94, 101, 102; 16/430,
16/431; 81/177.1, 475, 489, 490, 436
See application file for complete search history.

(56) **References Cited**

U.S. PATENT DOCUMENTS

1,049,650	A *	1/1913	Benjamin	81/436
1,711,062	A *	4/1929	Purinton	72/479
D310,011	S *	8/1990	Holland-Letz	D8/82
5,259,277	A *	11/1993	Zurbuchen	81/177.1
D346,943	S *	5/1994	Haberstroh	D8/83
D401,491	S *	11/1998	Shiao	D8/83
D418,035	S *	12/1999	Hatch	D8/83

D442,049	S *	5/2001	Shu	D8/83
D452,423	S *	12/2001	Shimansky	D8/83
6,629,338	B2 *	10/2003	Dierolf et al.	16/430
D487,690	S *	3/2004	Hu	D8/83
6,749,790	B1 *	6/2004	Lieser et al.	264/279
D553,464	S *	10/2007	Rinner	D8/83
D563,752	S *	3/2008	Fach	D8/83
D607,300	S *	1/2010	Lin	D8/107
8,032,991	B2 *	10/2011	Lawless	16/430
D686,899	S *	7/2013	Lin	D8/83
2002/0133911	A1 *	9/2002	Dierolf et al.	16/430
2008/0148909	A1 *	6/2008	Lai	81/177.85

* cited by examiner

Primary Examiner — Paula Greene

(57) **CLAIM**

The ornamental design for a handle of hand tools, as shown and described.

DESCRIPTION

FIG. 1 is a perspective view of a handle of hand tools showing my new design;
FIG. 2 is a front elevational view thereof;
FIG. 3 is a rear elevational view thereof;
FIG. 4 is a left side elevational view thereof;
FIG. 5 is a right side elevational view thereof;
FIG. 6 is a top plan view thereof; and,
FIG. 7 is a bottom plan view thereof, where those portions of the illustrated design indicated by broken lines form no part of the claimed design.

1 Claim, 2 Drawing Sheets

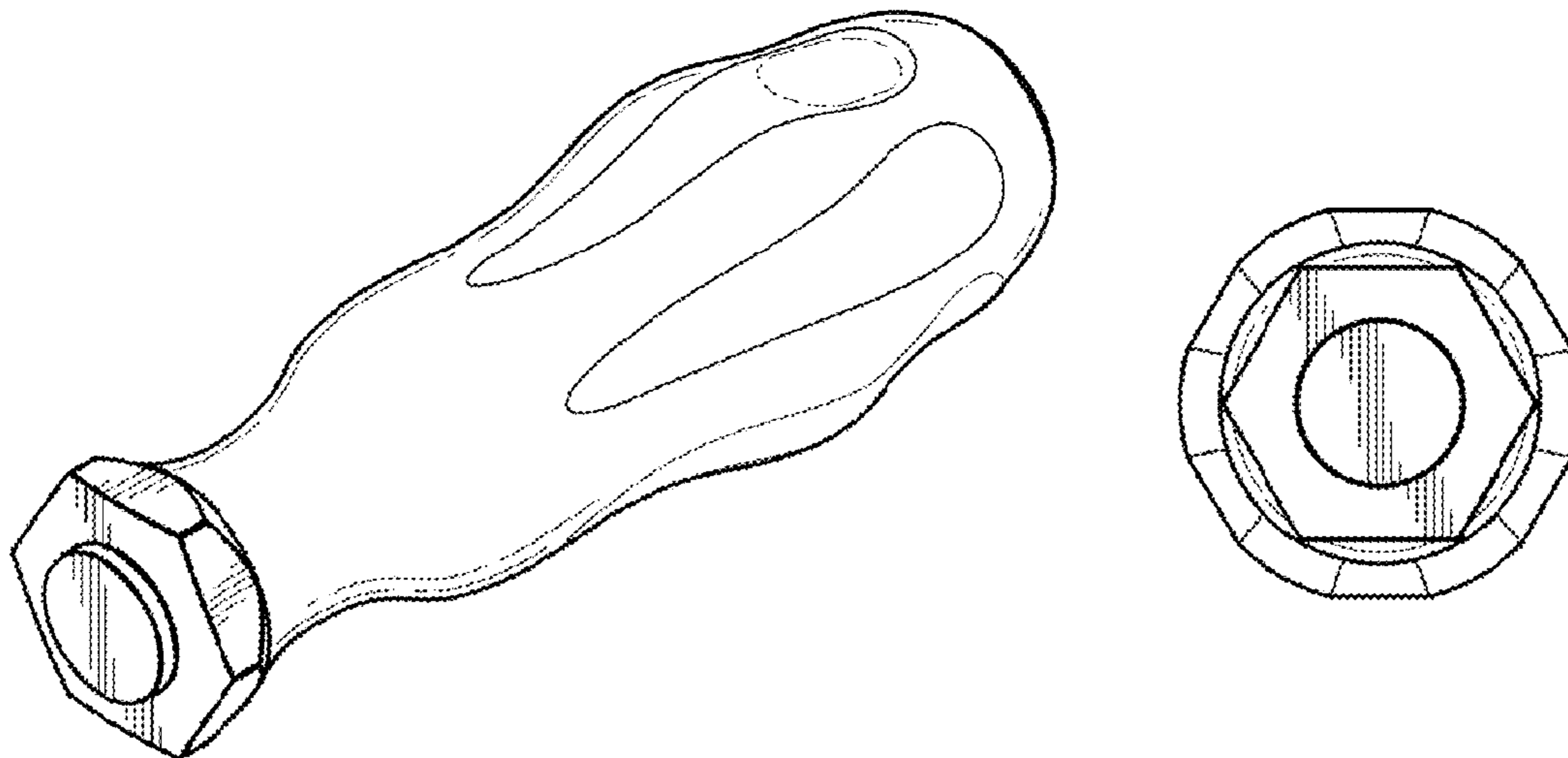

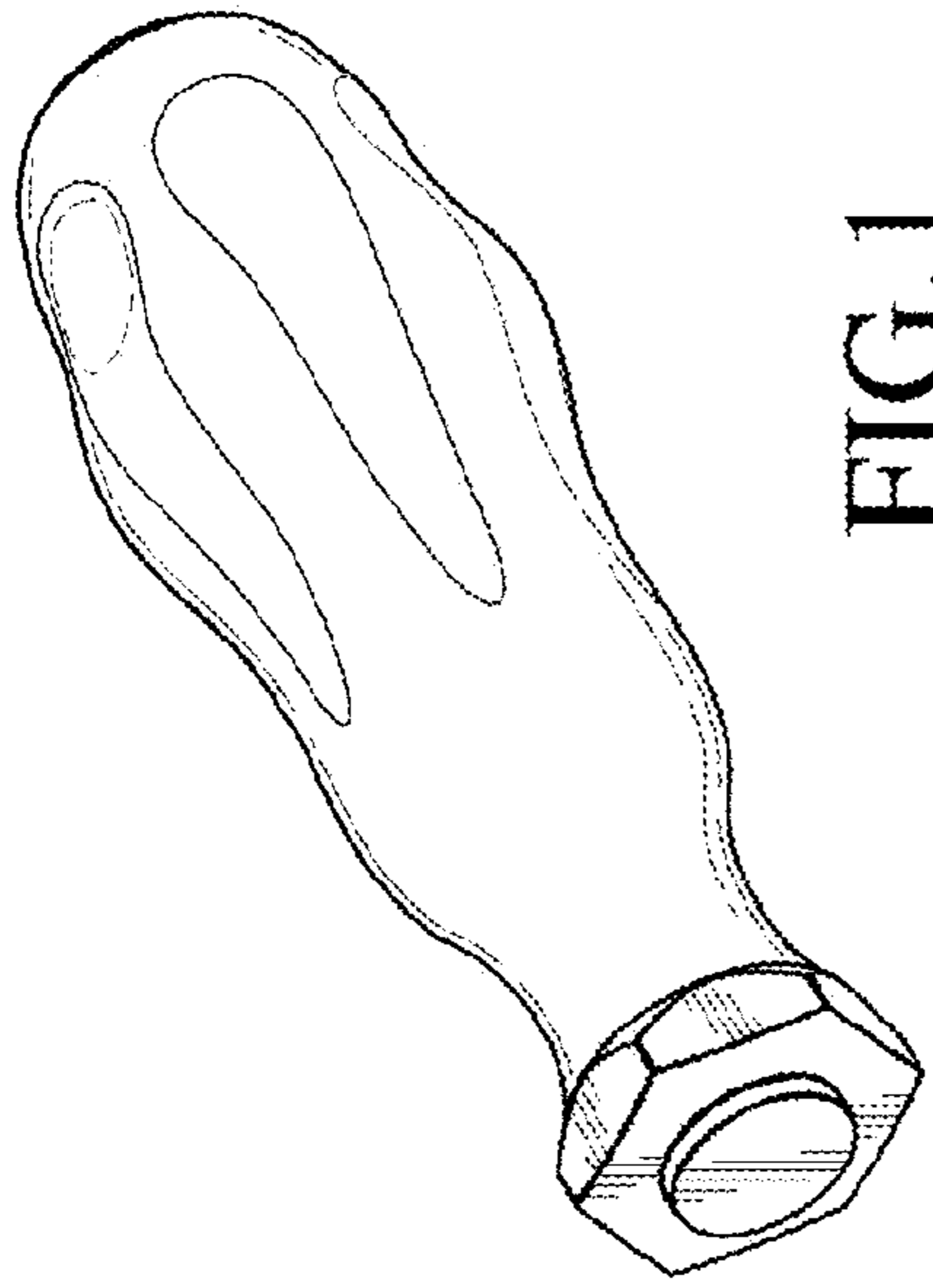

FIG. 1

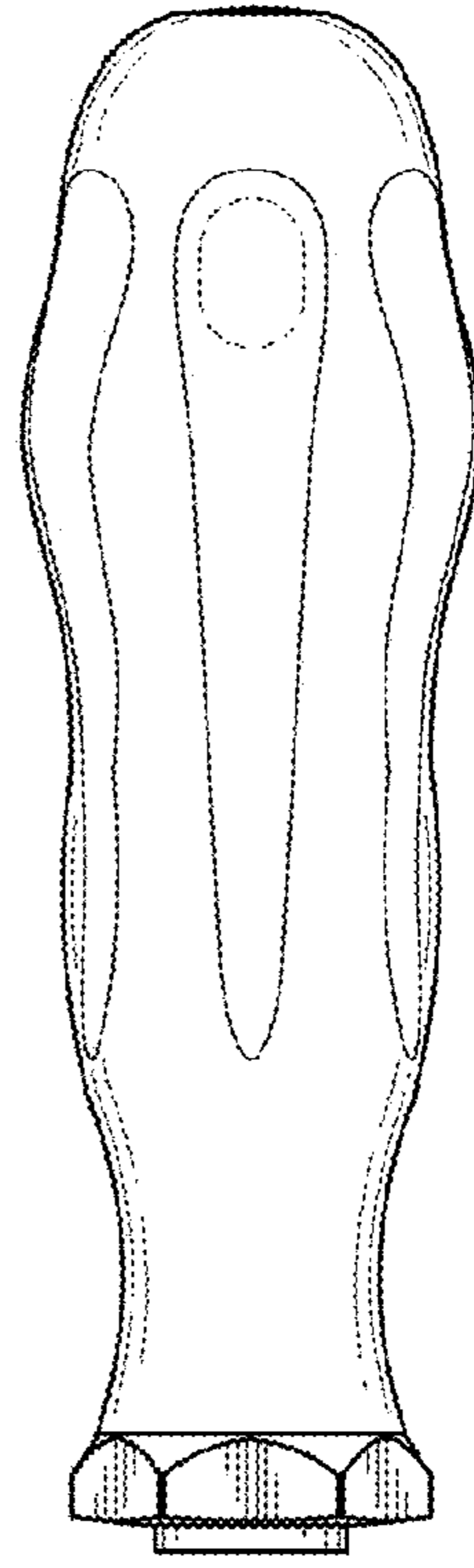

FIG. 7

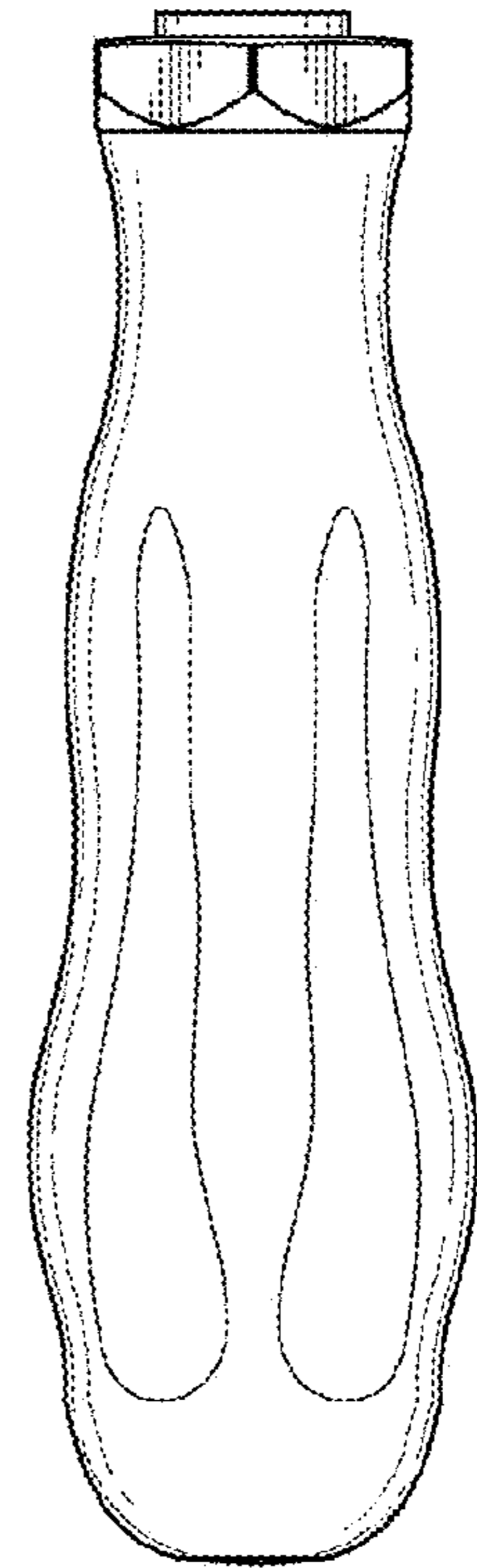

FIG. 3

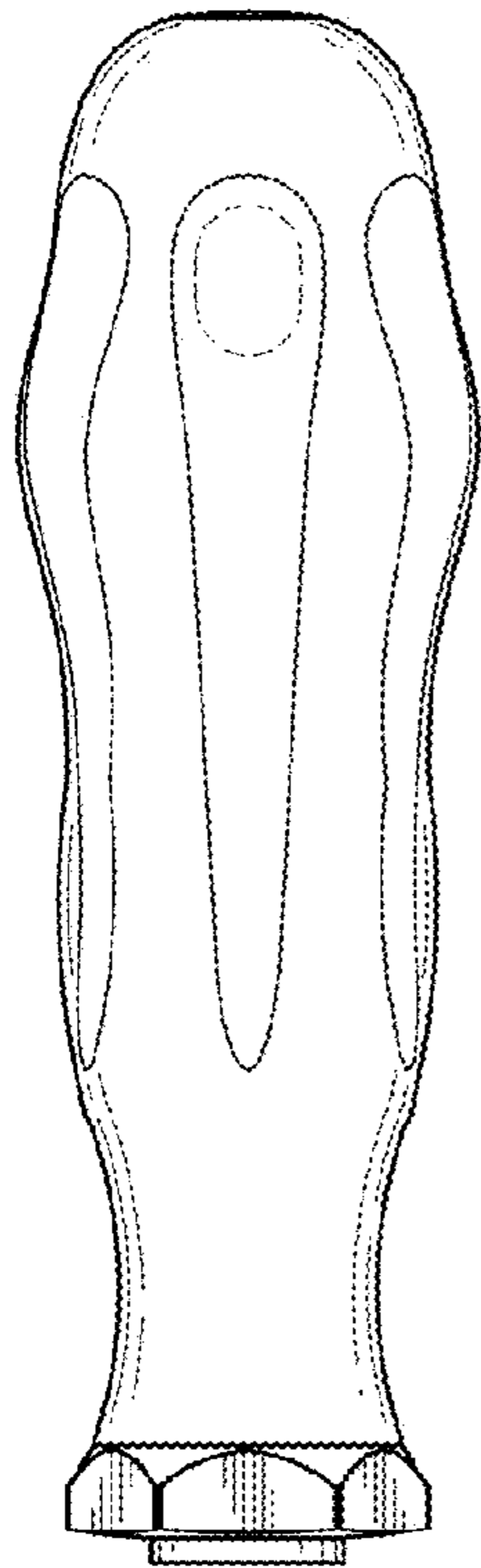

FIG. 6

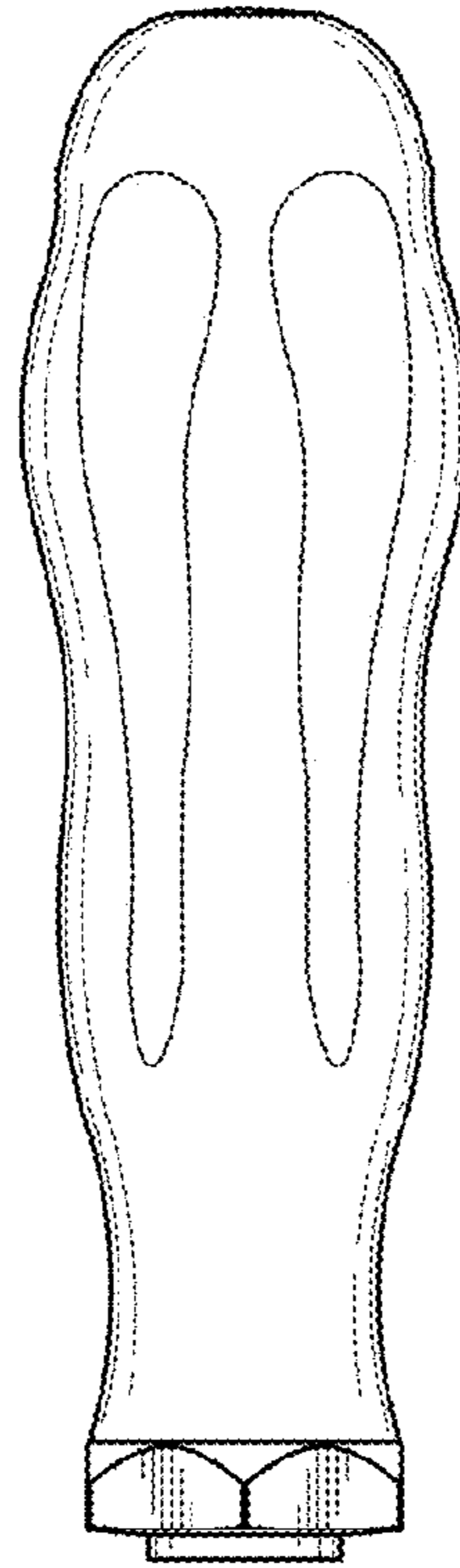

FIG. 2

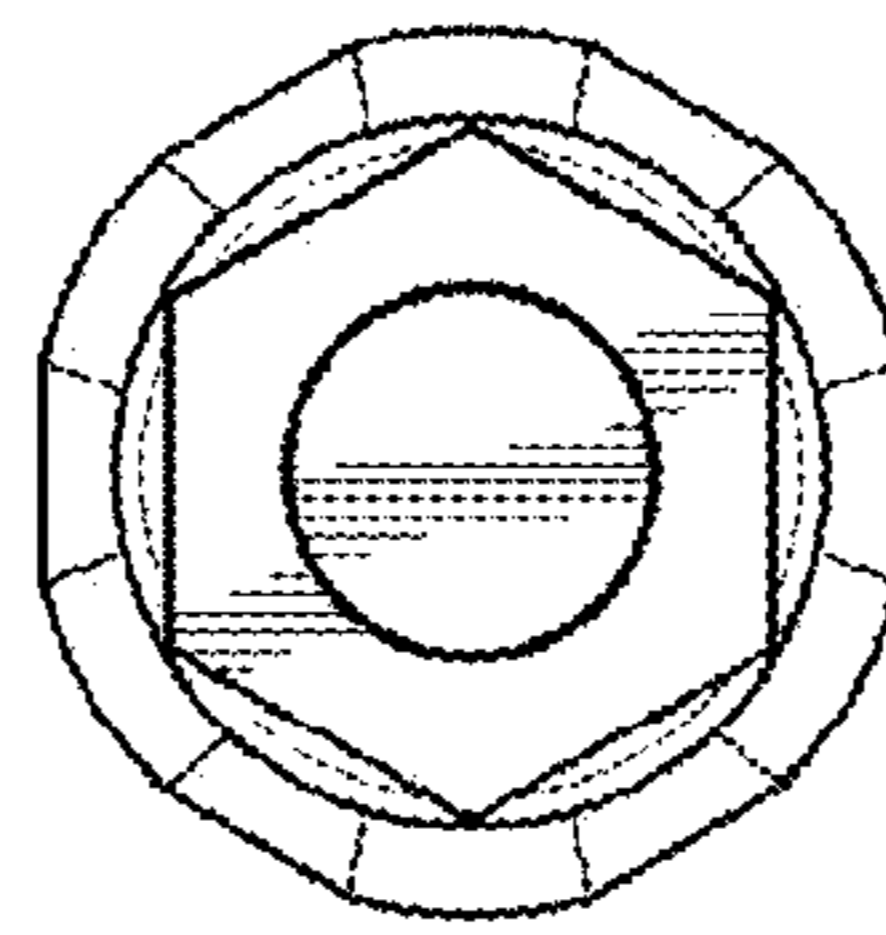

FIG. 4

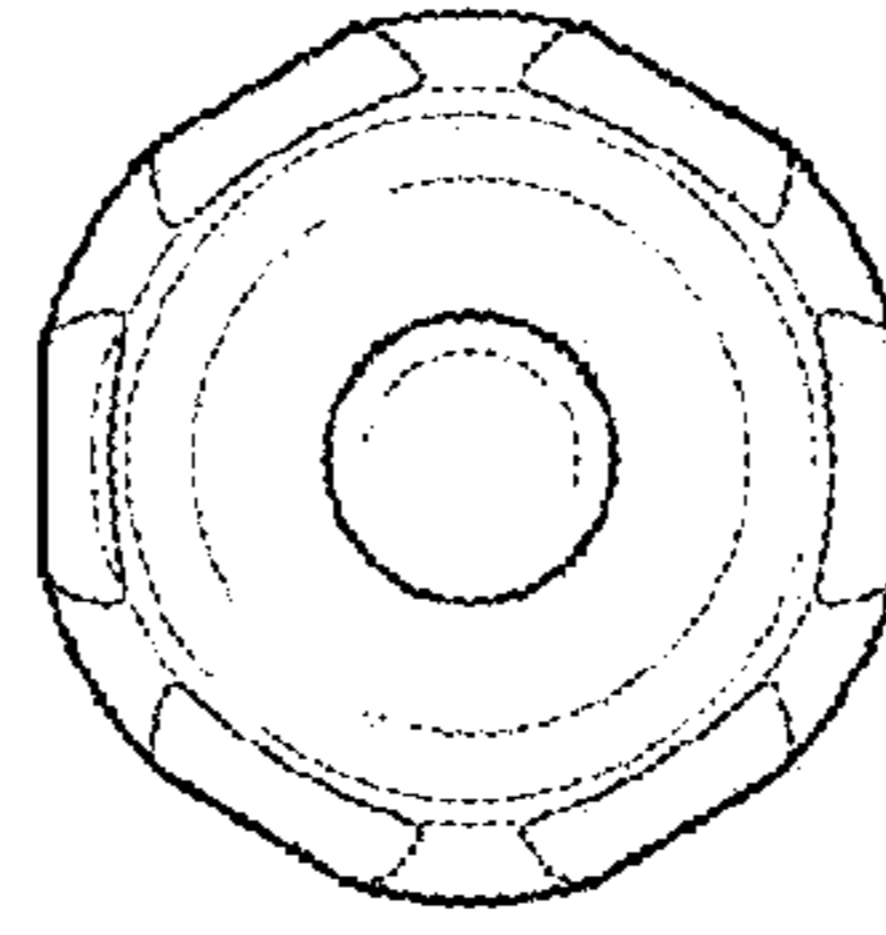

FIG. 5