



US00D709189S

(12) **United States Design Patent**
Doerr et al.

(10) **Patent No.:** **US D709,189 S**
(45) **Date of Patent:** **** Jul. 15, 2014**

(54) **MEDICAL HANDGRIP**

(56)

References Cited

(71) Applicants: **Daniel Glenn Doerr**, Orlando, FL (US);
Kenneth M. Roger, Casselberry, FL
(US); **Rogelio A. Insignares**, Winter
Park, FL (US); **Gary Wayne**
Haberland, Winter Park, FL (US);
Roland Strelitzki, Altamonte Springs,
FL (US); **John A. Farnella, Jr.**, Orlando,
FL (US)

(72) Inventors: **Daniel Glenn Doerr**, Orlando, FL (US);
Kenneth M. Roger, Casselberry, FL
(US); **Rogelio A. Insignares**, Winter
Park, FL (US); **Gary Wayne**
Haberland, Winter Park, FL (US);
Roland Strelitzki, Altamonte Springs,
FL (US); **John A. Farnella, Jr.**, Orlando,
FL (US)

(**) Term: **14 Years**

(21) Appl. No.: **29/435,618**

(22) Filed: **Oct. 25, 2012**

(51) **LOC (10) Cl.** **24-02**

(52) **U.S. Cl.**
USPC **D24/133**

(58) **Field of Classification Search**
USPC D24/133, 137, 138, 143, 144, 145, 146,
D24/147, 148, 149; 606/1, 80, 85, 130, 139,
606/148, 167, 169, 170, 171, 174, 175, 176,
606/180, 205, 206; 604/22, 27; 600/104,
600/153, 154, 564

See application file for complete search history.

U.S. PATENT DOCUMENTS

D544,602	S	*	6/2007	Hughett et al.	D24/144
D598,549	S	*	8/2009	Cantu et al.	D24/146
D634,424	S	*	3/2011	Morejon	D24/146
D647,613	S	*	10/2011	Paget et al.	D24/133
D652,517	S	*	1/2012	Weaver	D24/134
D667,110	S	*	9/2012	Wright et al.	D24/133
D667,111	S	*	9/2012	Robinson	D24/133
D695,896	S	*	12/2013	Insignares et al.	D24/133
D698,441	S	*	1/2014	Meguro et al.	D24/138
D699,348	S	*	2/2014	Morejon	D24/147
2004/0254538	A1	*	12/2004	Murphy et al.	604/181
2011/0180072	A1	*	7/2011	Morejon	128/207.14

* cited by examiner

Primary Examiner — Bridget L Eland

(57) **CLAIM**

The ornamental design for a medical handgrip, as shown and described.

DESCRIPTION

FIG. 1 is a perspective view of a medical handgrip showing our new design;
FIG. 2 is an enlarged left side elevational view thereof;
FIG. 3 is an enlarged right side elevational view thereof;
FIG. 4 is an enlarged top plan view thereof;
FIG. 5 is an enlarged bottom plan view thereof;
FIG. 6 is a rear elevational view thereof; and,
FIG. 7 is a front elevational view thereof.
The broken lines shown on the figures are included for the purpose of illustrating portions of the medical handgrip that form no part of the claimed design.

1 Claim, 3 Drawing Sheets

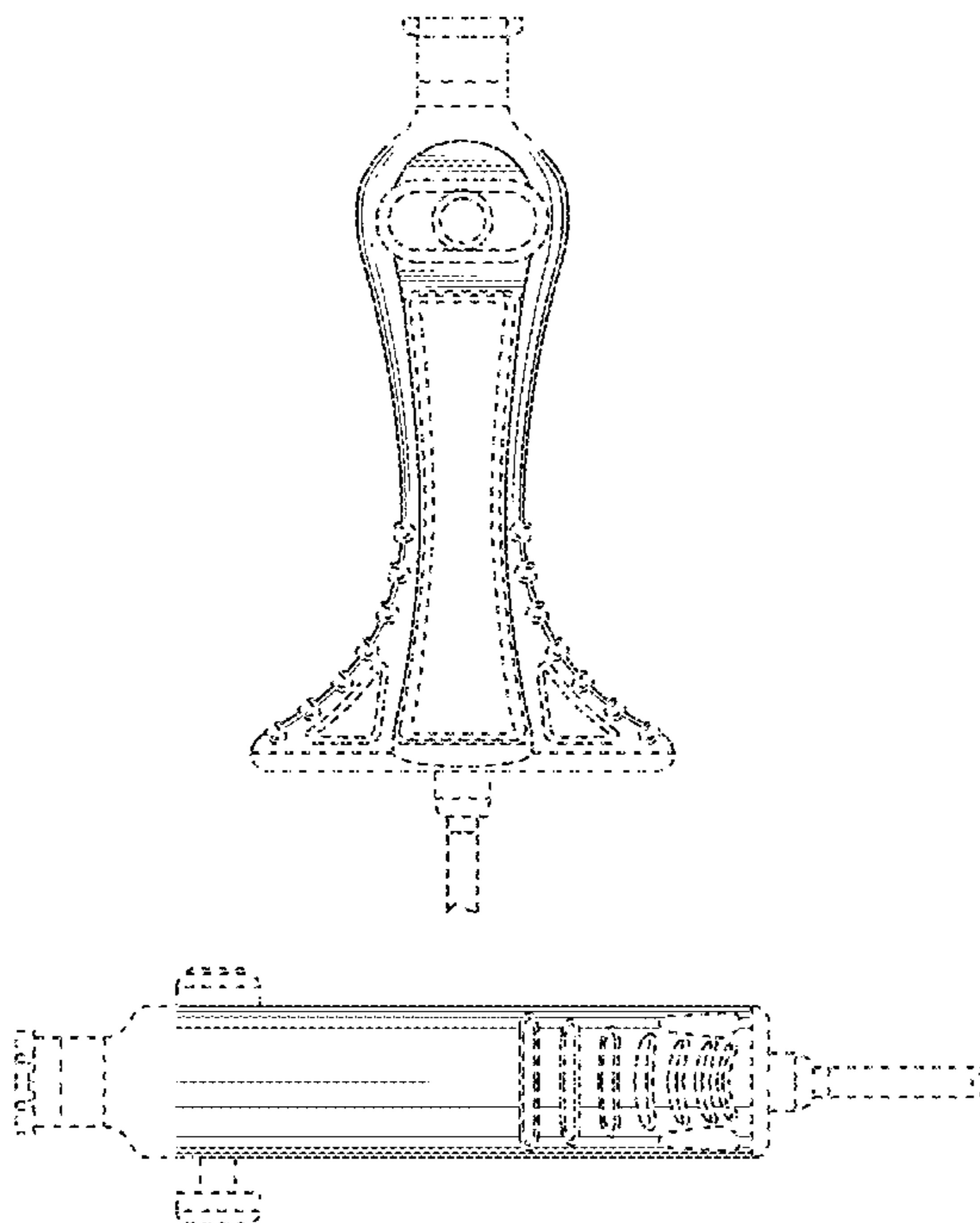

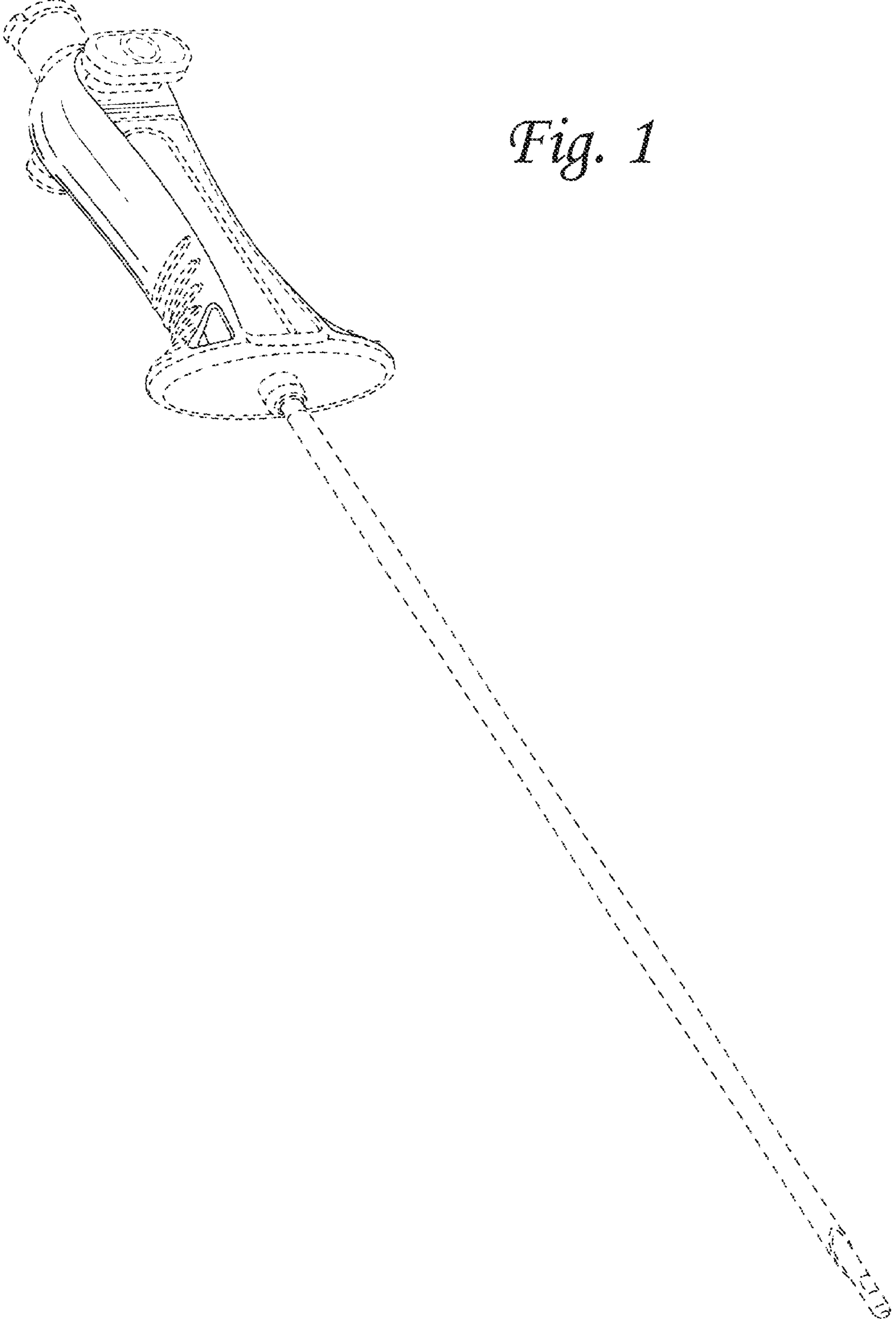

Fig. 1

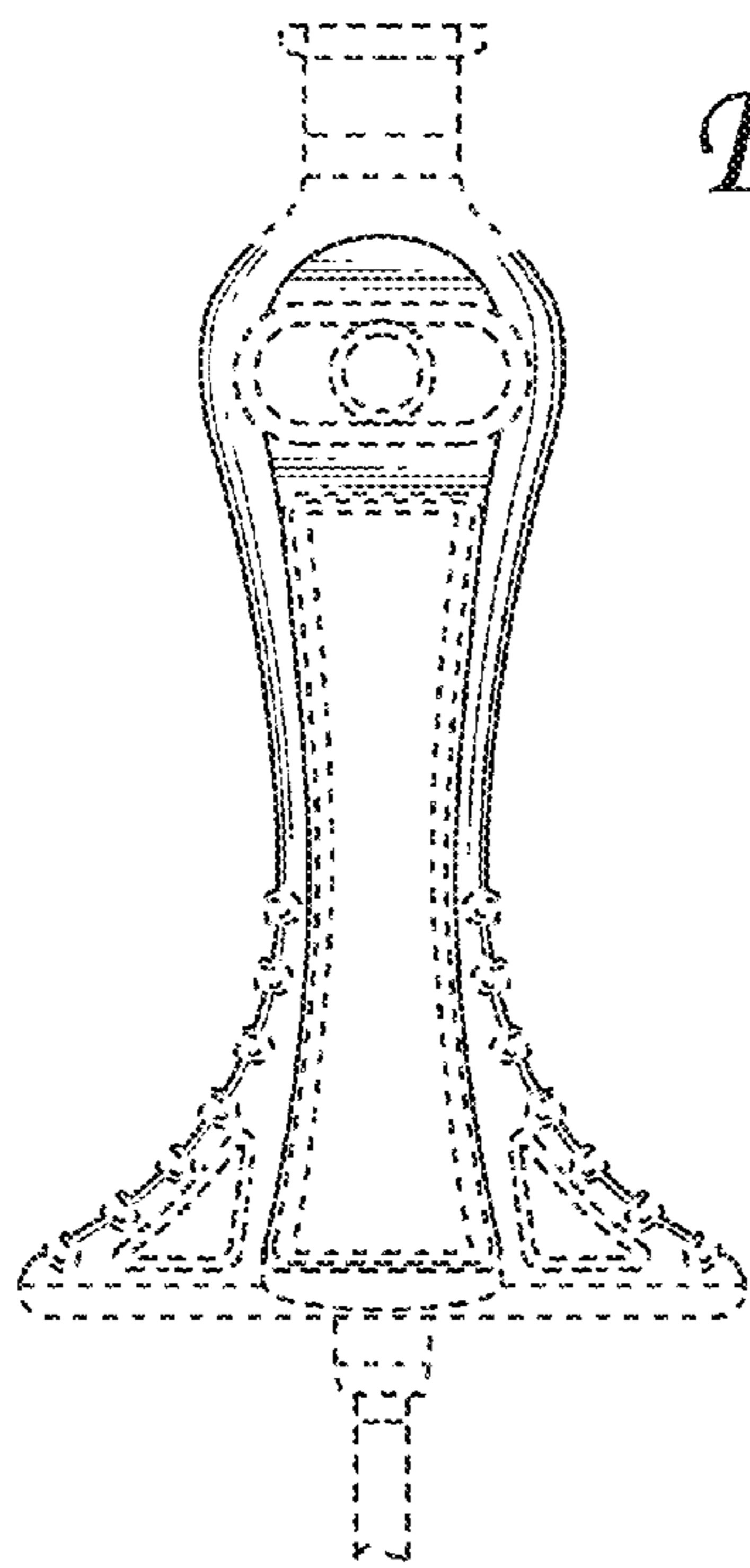

Fig. 2

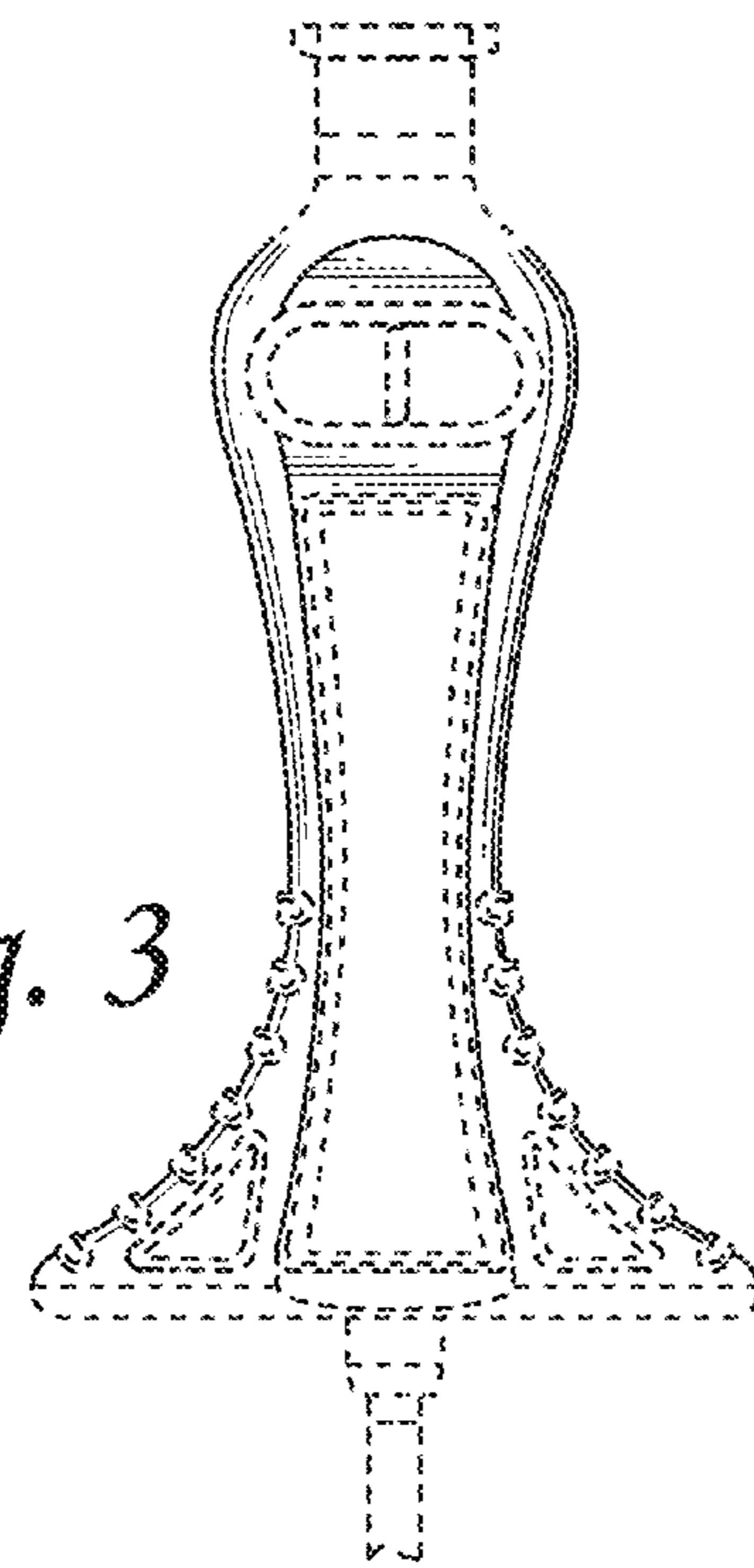

Fig. 3

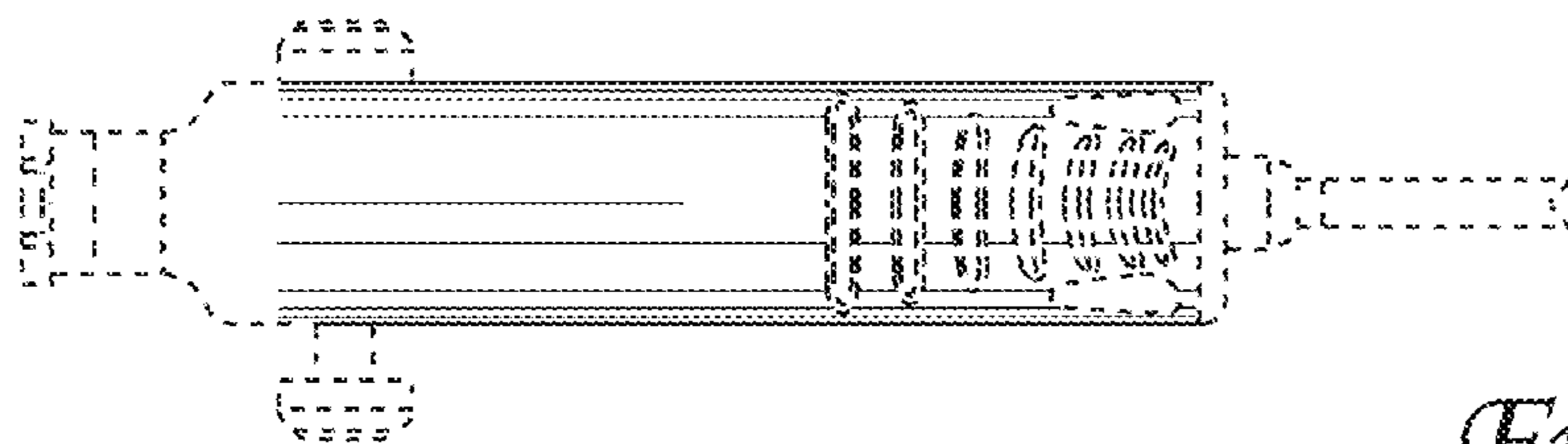

Fig. 4

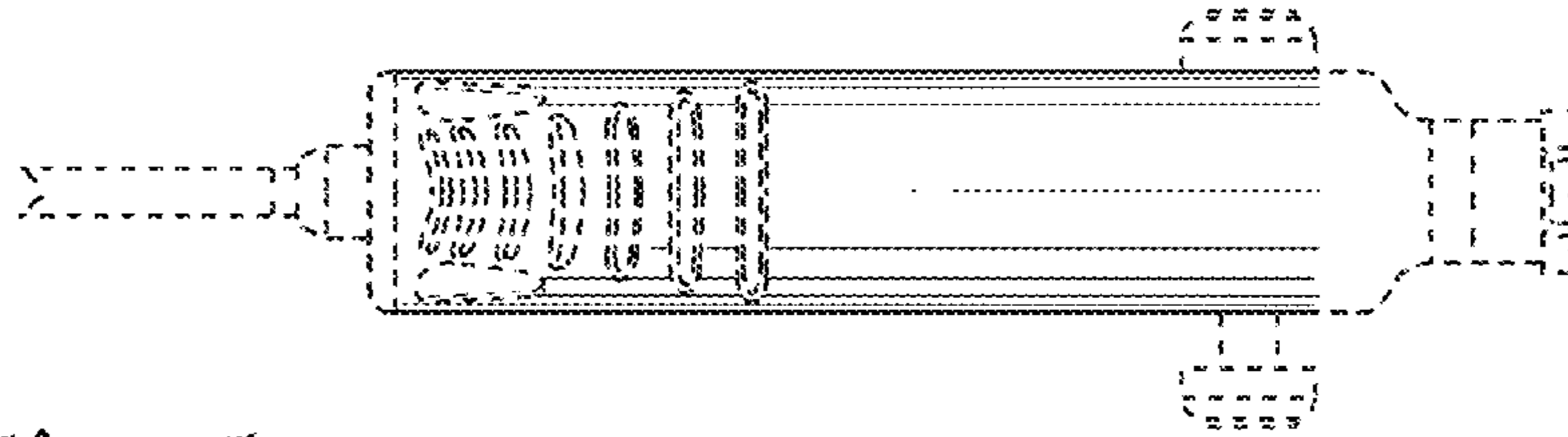

Fig. 5

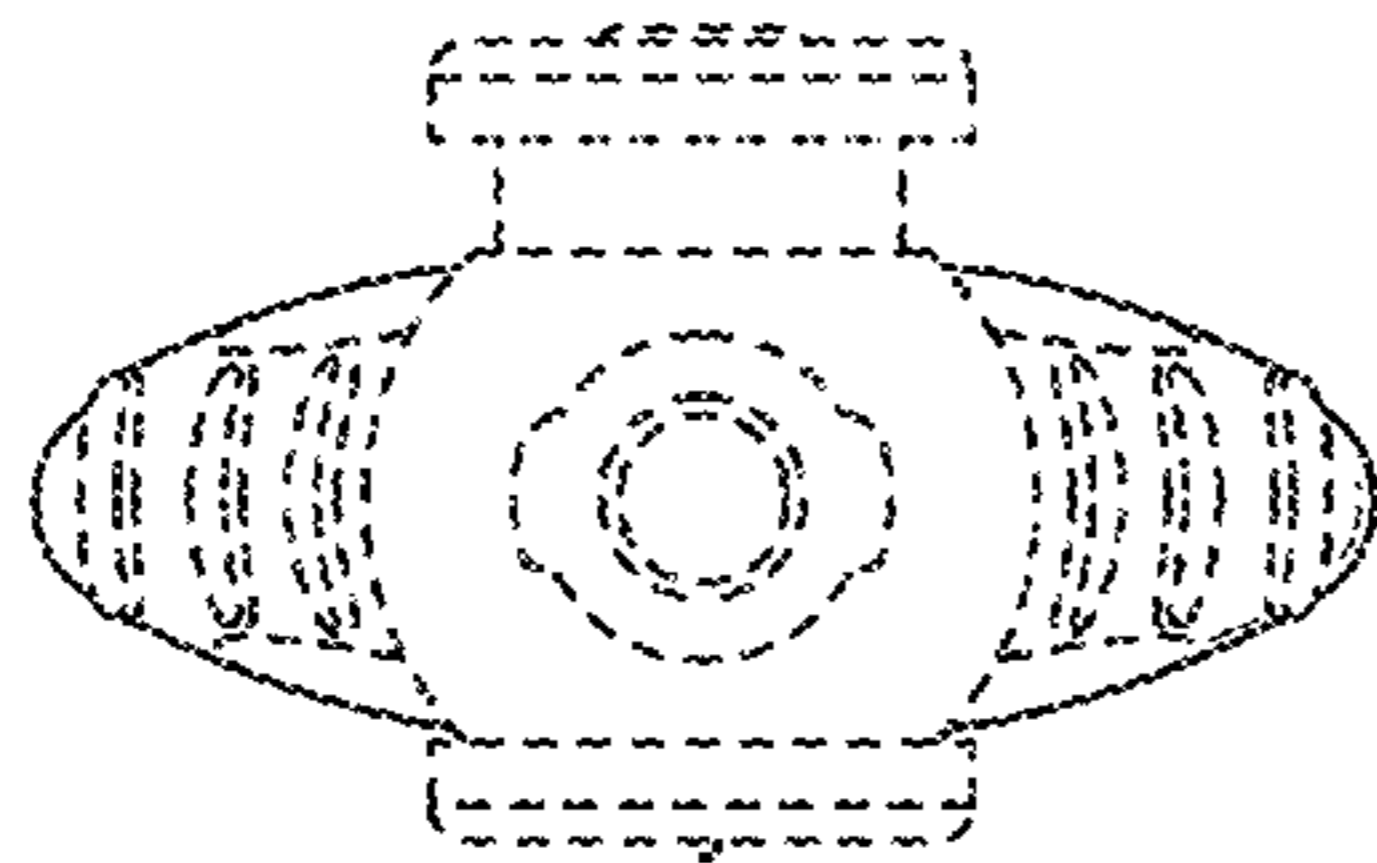

Fig. 6

Fig. 7

