



US00D709121S

(12) **United States Design Patent**  
**Lin**

(10) **Patent No.:** **US D709,121 S**  
(45) **Date of Patent:** **\*\* Jul. 15, 2014**

(54) **PROJECTOR**

(71) Applicant: **Delta Electronics, Inc.**, Taoyuan Hsien (TW)

(72) Inventor: **Cheng-Yu Lin**, Taoyuan Hsien (TW)

(73) Assignee: **Delta Electronics, Inc.**, Taoyuan Hsien (TW)

(\*\*) Term: **14 Years**

(21) Appl. No.: **29/450,485**

(22) Filed: **Mar. 18, 2013**

(51) **LOC (10) Cl.** ..... **16-02**

(52) **U.S. Cl.**

USPC ..... **D16/235**; D16/230

(58) **Field of Classification Search**

USPC ..... D16/208, 219, 221, 223–231, 234–235;  
D21/514; 353/115, 119, 122

See application file for complete search history.

(56) **References Cited**

U.S. PATENT DOCUMENTS

D482,715 S \* 11/2003 Schoenert et al. .... D16/230  
D503,733 S \* 4/2005 Kurokawa ..... D16/230

(Continued)

FOREIGN PATENT DOCUMENTS

CN 301410745 \* 12/2010  
CN 301410746 \* 12/2010

*Primary Examiner* — Wan Laymon

(74) *Attorney, Agent, or Firm* — Kirton McConkie; Evan R. Witt

(57) **CLAIM**

The ornamental design for a projector, as shown and described.

**DESCRIPTION**

FIG. 1 is a perspective view of a first embodiment of a projector showing my new design;

FIG. 2 is a front elevation view thereof;  
FIG. 3 is a rear elevation view thereof;  
FIG. 4 is a left side elevation view thereof;  
FIG. 5 is a right side elevation view thereof;  
FIG. 6 is a top plan view thereof;  
FIG. 7 is a bottom plan view thereof;  
FIGS. 8-10 are exemplary top plan views showing projectors that have the keypad disposed at different positions;  
FIG. 11 is another perspective view showing a second embodiment of a projector according to the present design;  
FIG. 12 is front elevation view thereof;  
FIG. 13 is a rear elevation view thereof;  
FIG. 14 is a left side elevation view thereof;  
FIG. 15 is a right side elevation view thereof;  
FIG. 16 is a top plan view thereof;  
FIG. 17 is a bottom plan view thereof;  
FIGS. 18-20 are exemplary top plan views showing projectors that have the keypad disposed at different positions;  
FIG. 21 is another perspective view showing a third embodiment of a projector according to the present design;  
FIG. 22 is front elevation view thereof;  
FIG. 23 is a rear elevation view thereof;  
FIG. 24 is a left side elevation view thereof;  
FIG. 25 is a right side elevation view thereof;  
FIG. 26 is a top plan view thereof; and  
FIG. 27 is a bottom plan view thereof.  
FIGS. 28-30 are exemplary top plan views showing projectors that have the keypad disposed at different positions;  
FIG. 31 is another perspective view showing a fourth embodiment of a projector according to the present design;  
FIG. 32 is front elevation view thereof;  
FIG. 33 is a rear elevation view thereof;  
FIG. 34 is a left side elevation view thereof;  
FIG. 35 is a right side elevation view thereof;  
FIG. 36 is a top plan view thereof; and  
FIG. 37 is a bottom plan view thereof; and,  
FIGS. 38-40 are exemplary top plan views showing projectors that have the keypad disposed at different positions.  
The broken lines are for the purpose of illustrating portions of the projector and form no part of the claimed design.

**1 Claim, 32 Drawing Sheets**

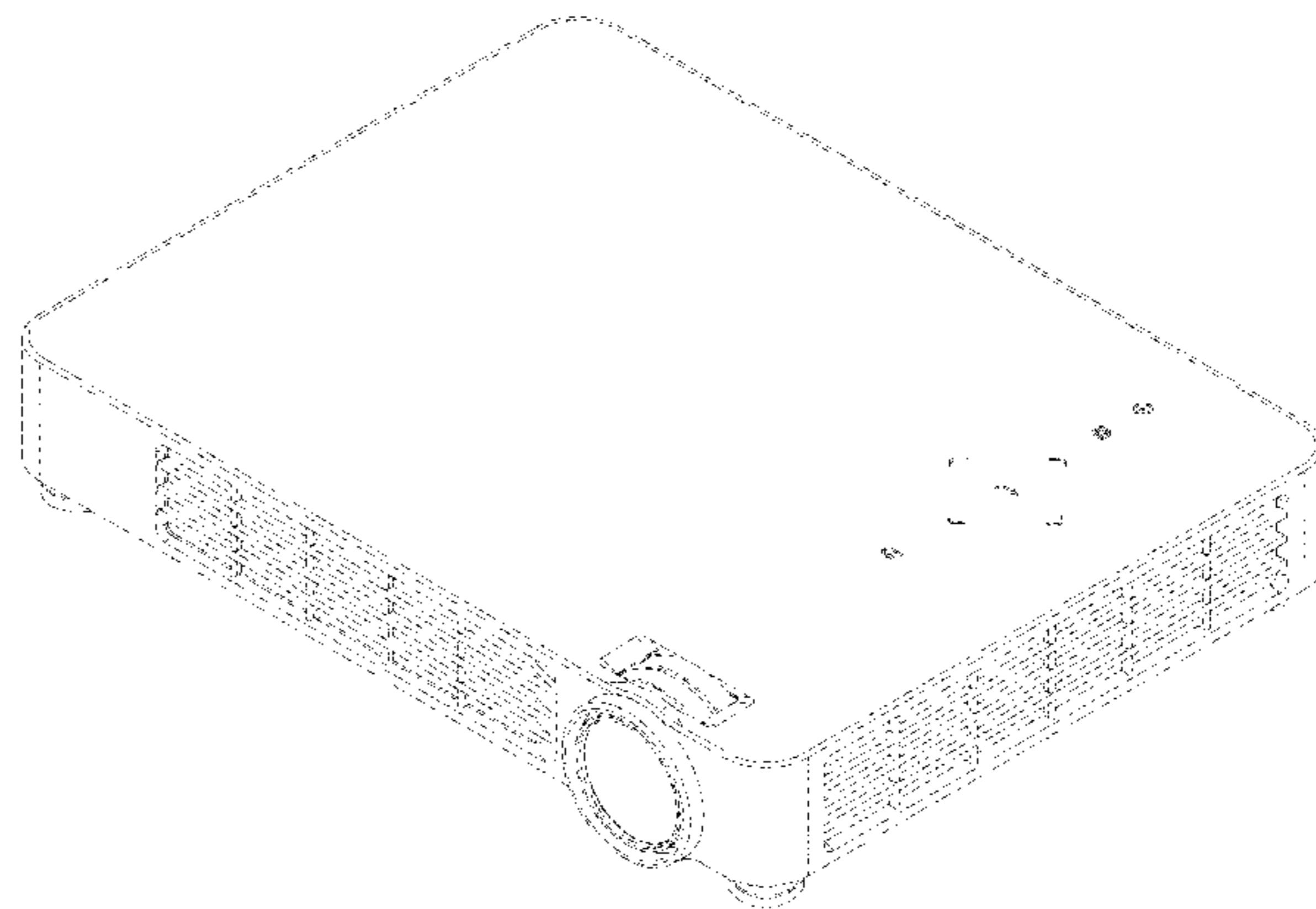
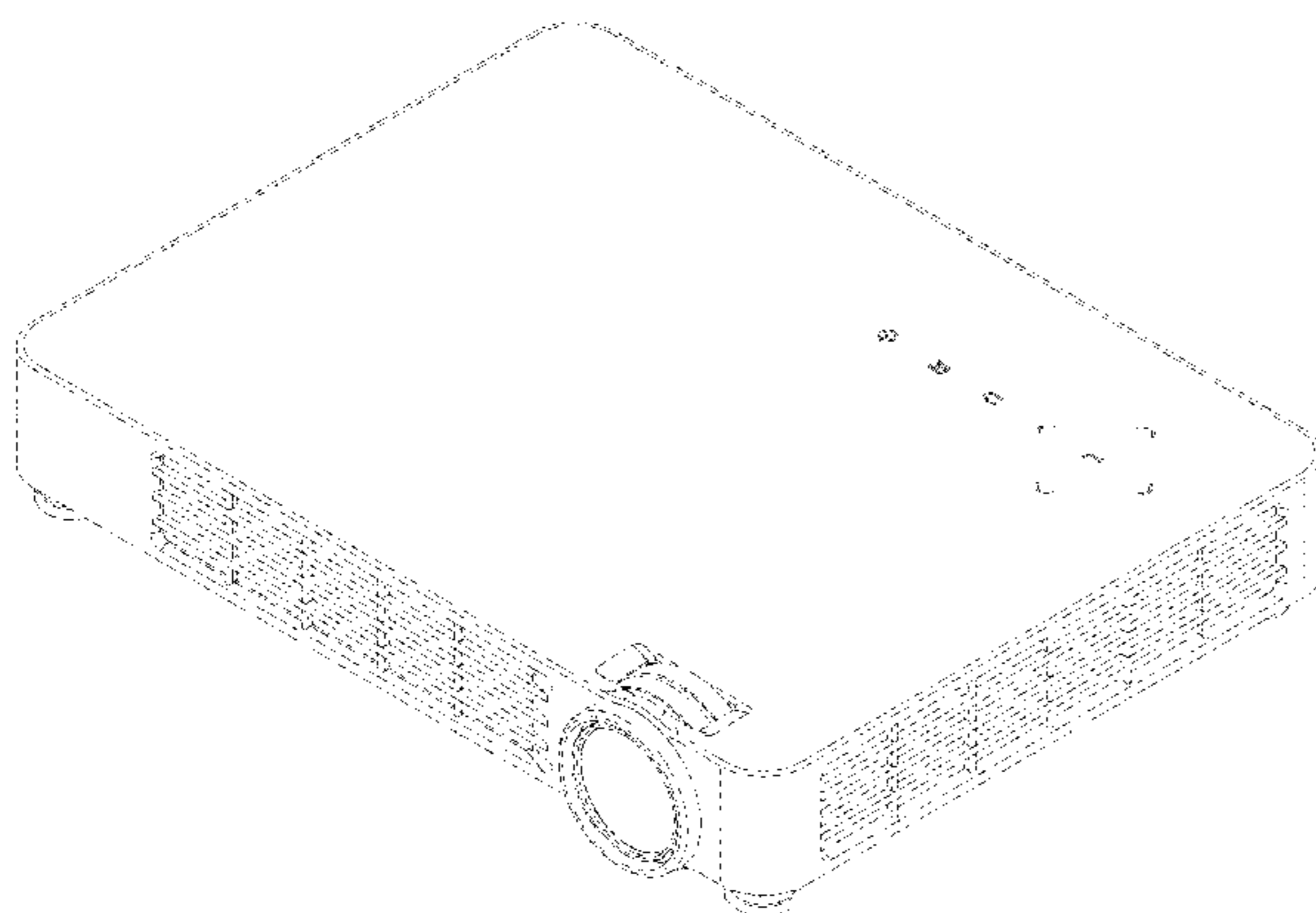

(56)

**References Cited**

U.S. PATENT DOCUMENTS

D506,770 S \* 6/2005 Saeki et al. .... D16/230  
D550,269 S \* 9/2007 Salvatori et al. .... D16/230  
D555,185 S \* 11/2007 Nozue et al. .... D16/230  
D555,696 S \* 11/2007 Naruki ..... D16/230

D575,811 S \* 8/2008 Ohki et al. .... D16/230  
D610,187 S \* 2/2010 Kim et al. .... D16/230  
D631,904 S \* 2/2011 Kim et al. .... D16/230  
D647,120 S \* 10/2011 Kawabe et al. .... D16/230  
8,104,902 B2 \* 1/2012 Mao et al. .... 353/119

\* cited by examiner

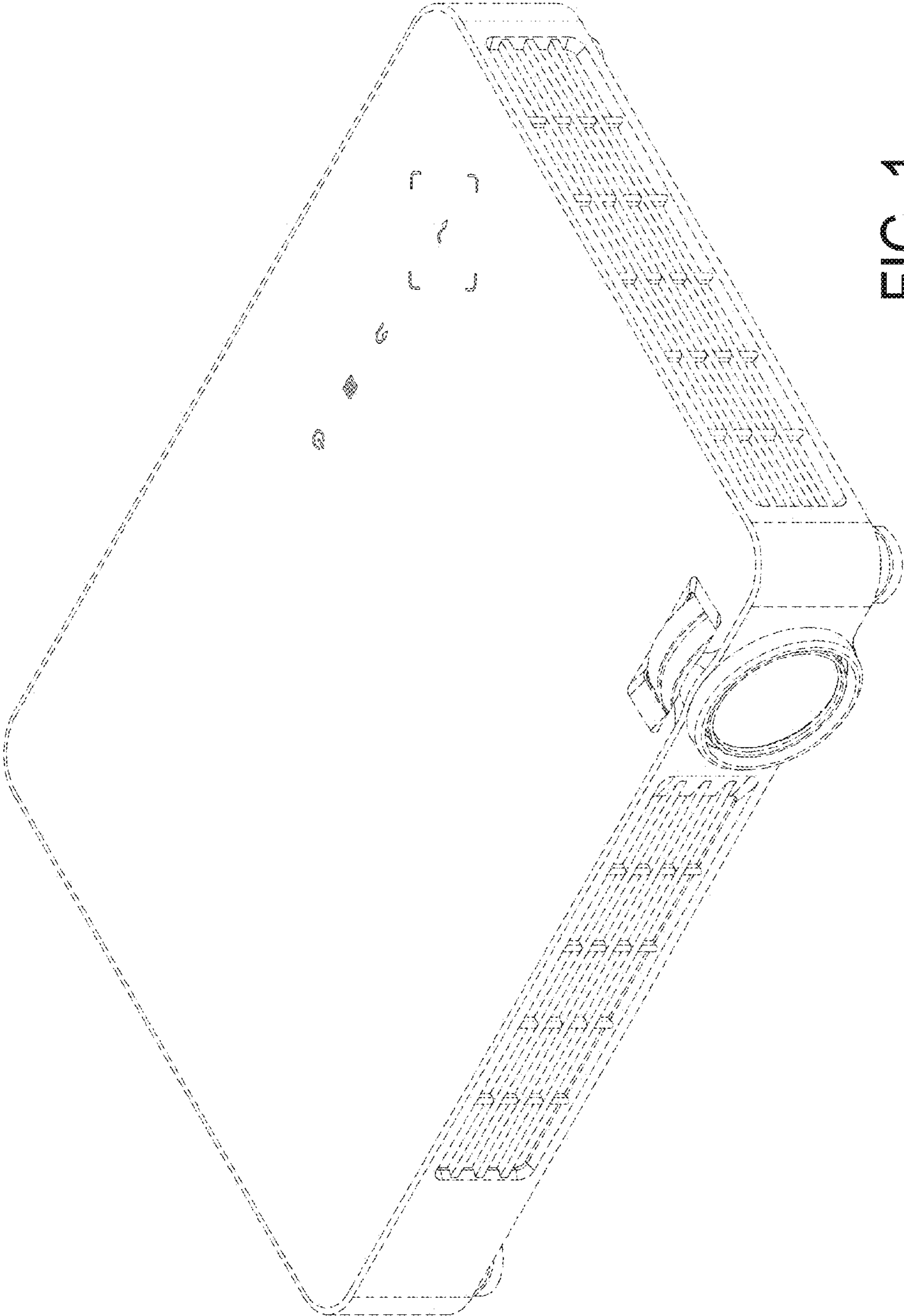

FIG. 1

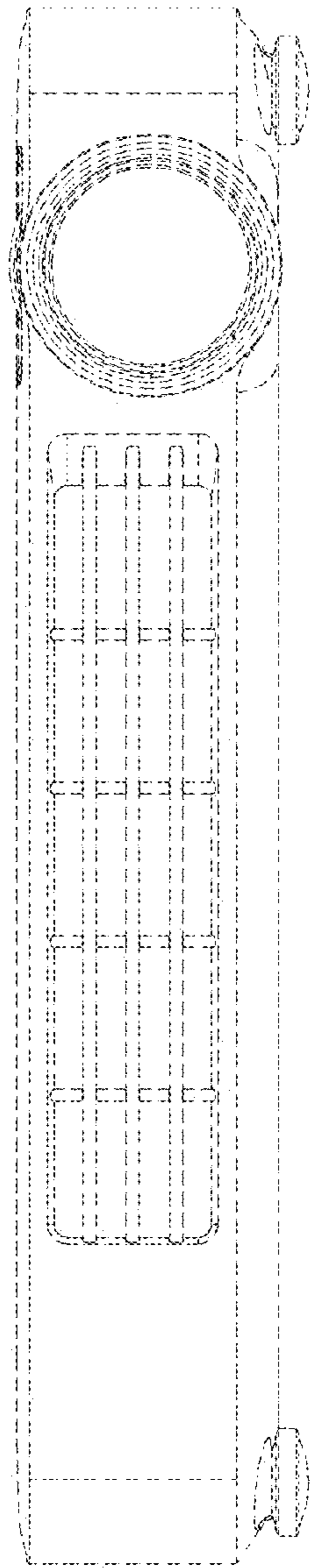

FIG. 2

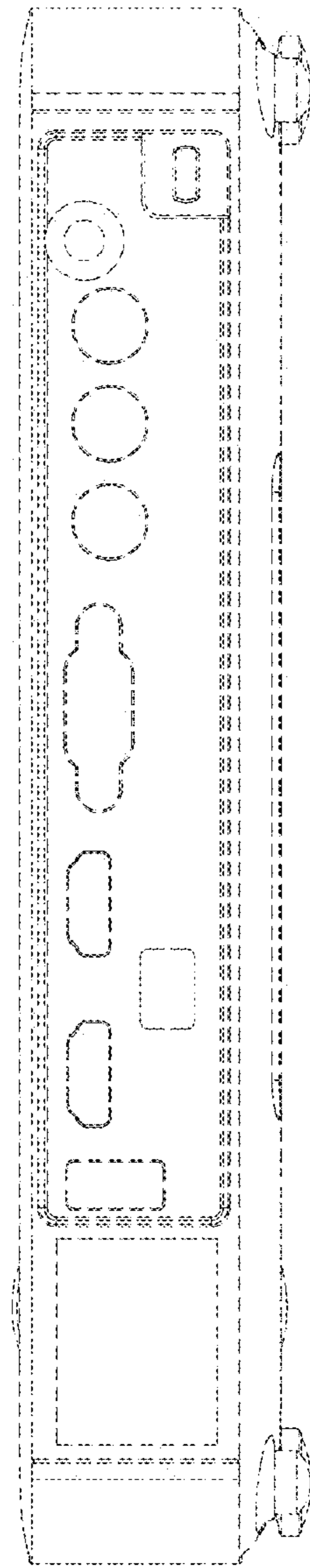

FIG. 3



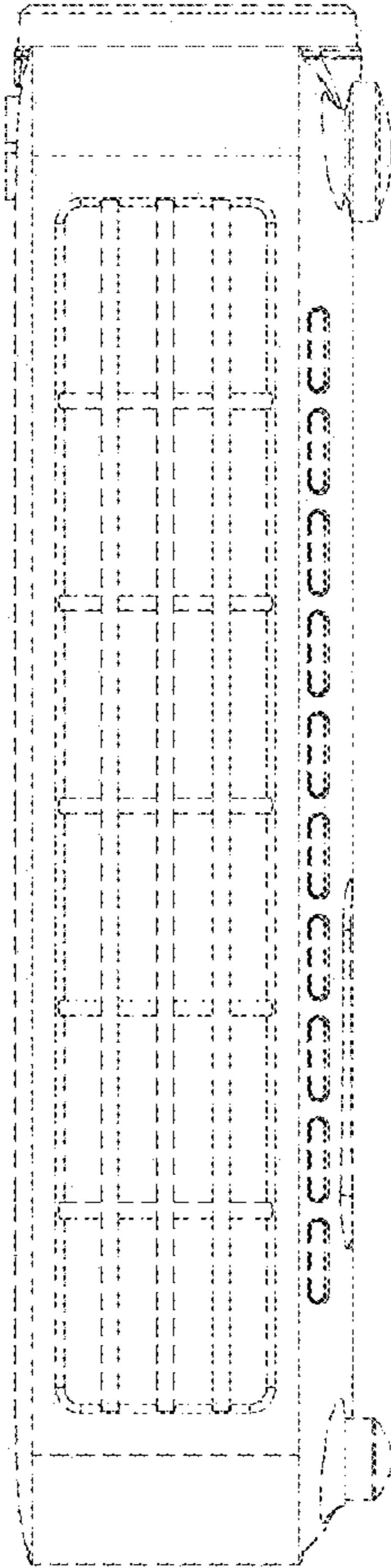

FIG. 4

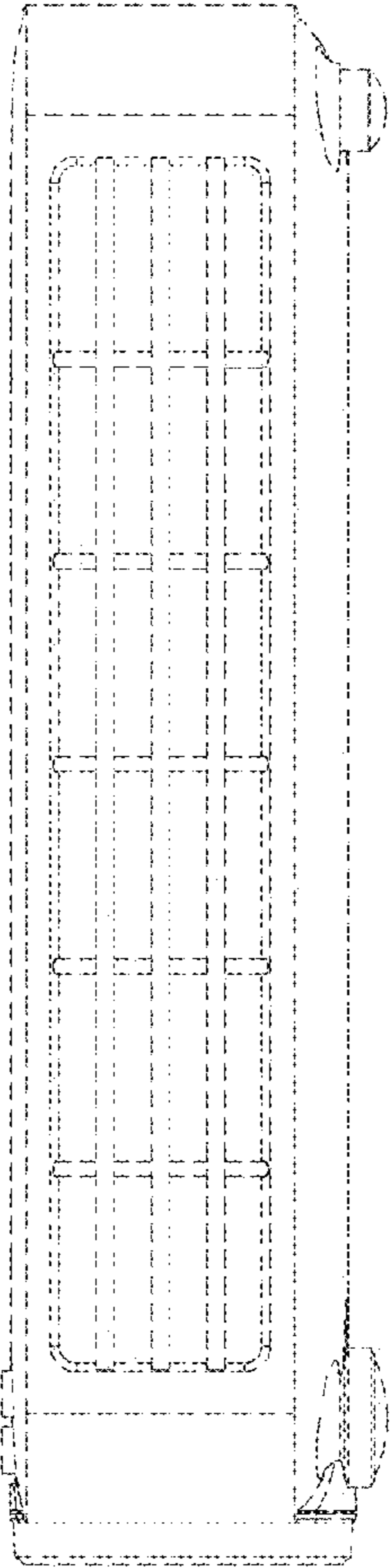

FIG. 5

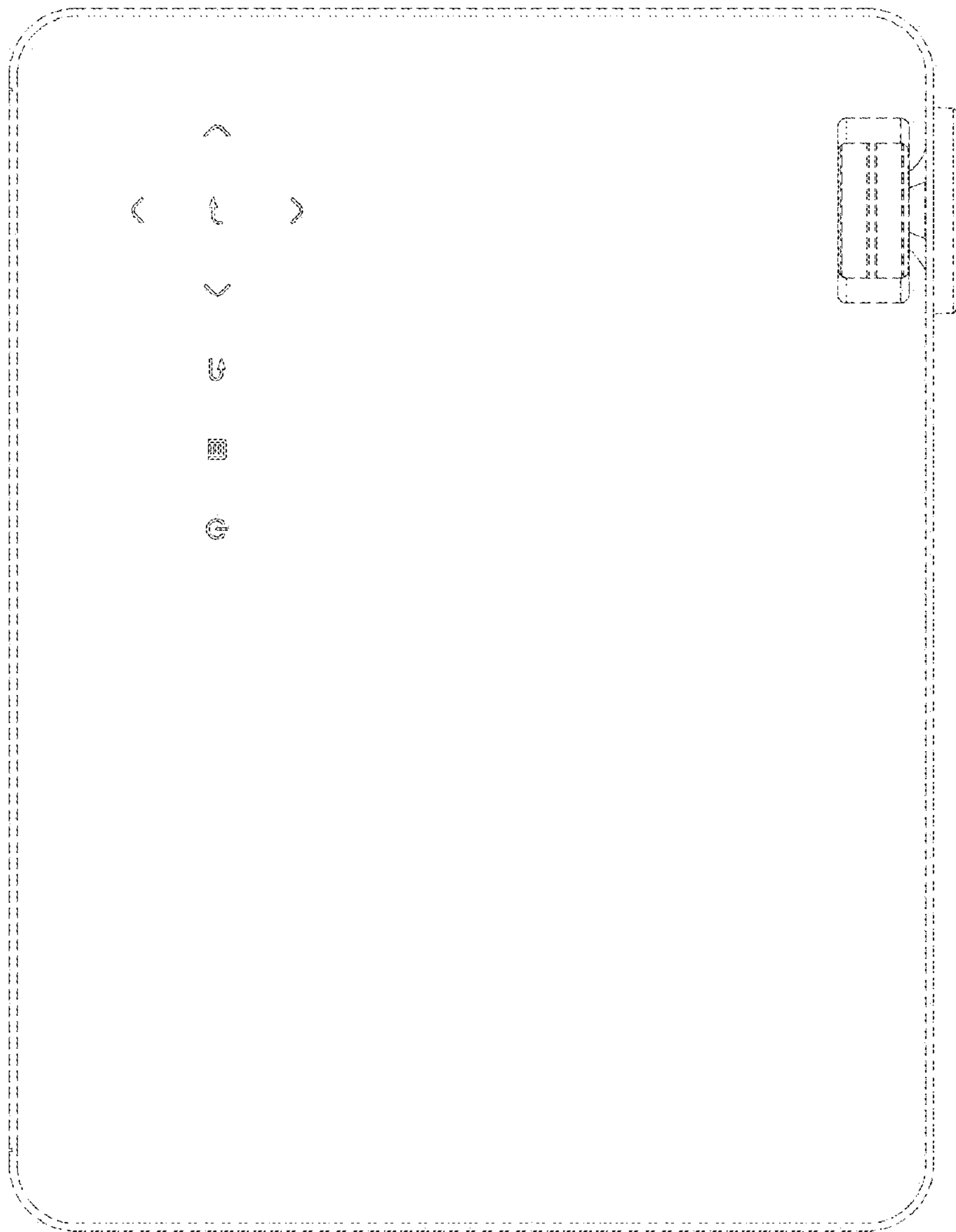

FIG. 6

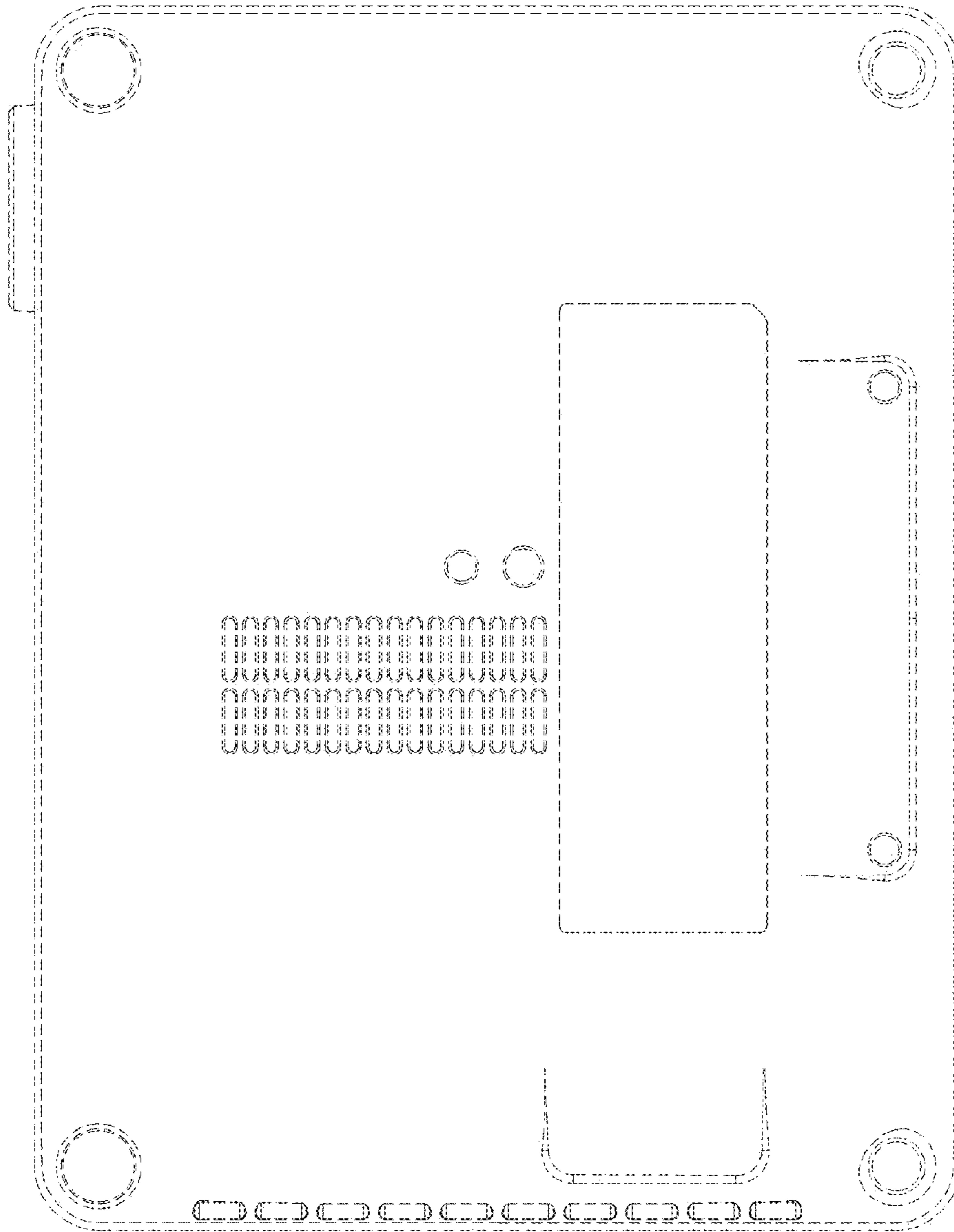

FIG. 7

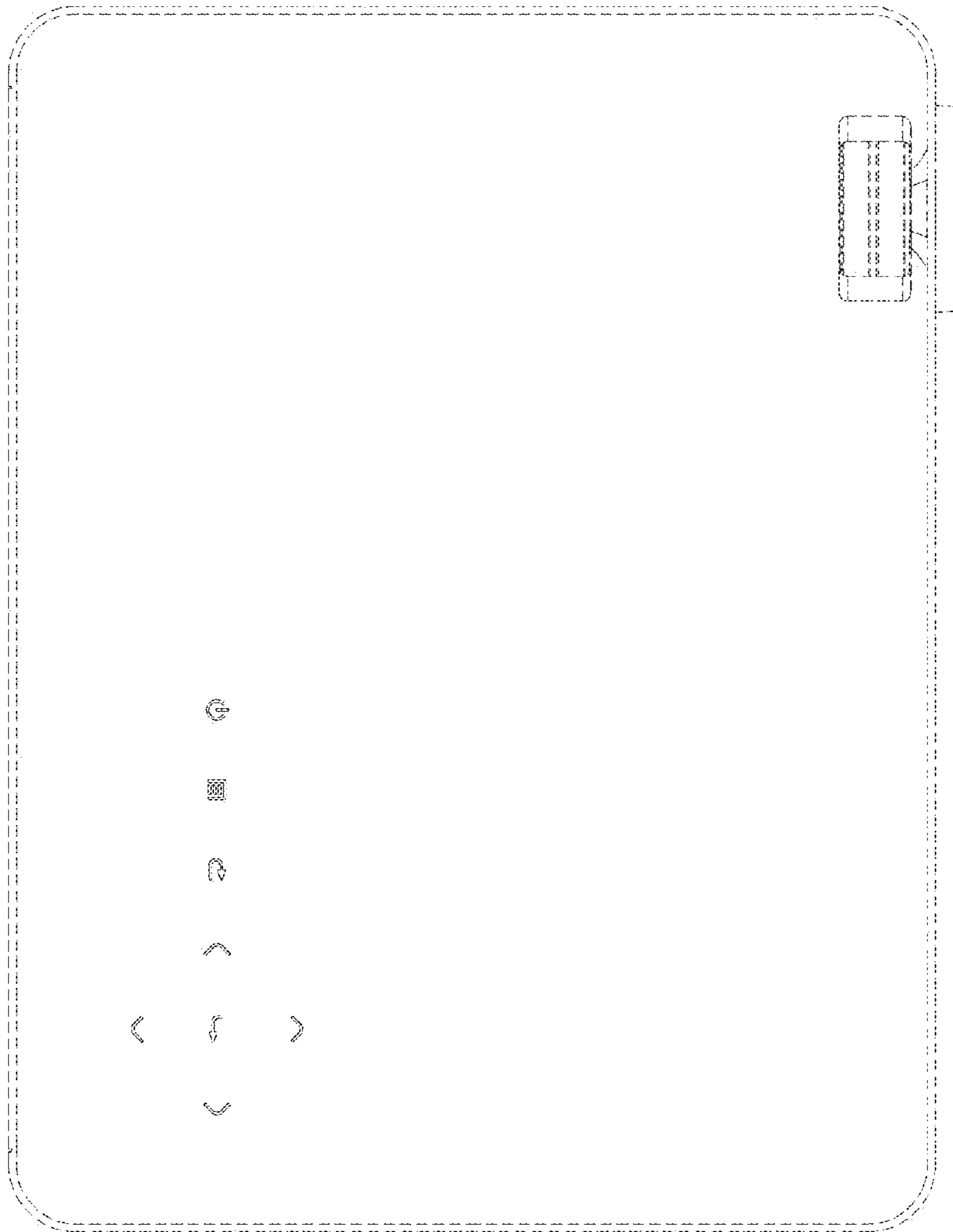

FIG. 8



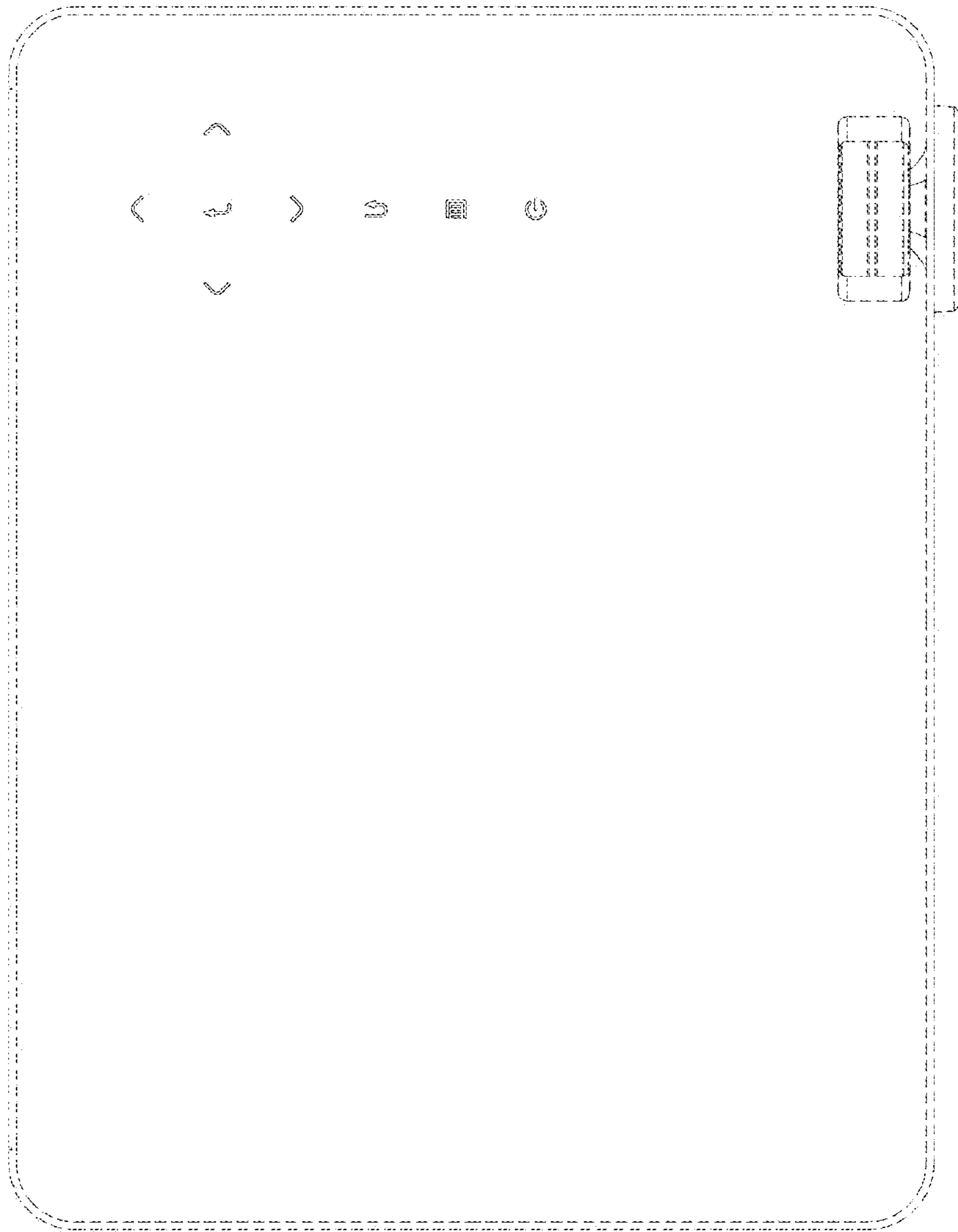

FIG. 9

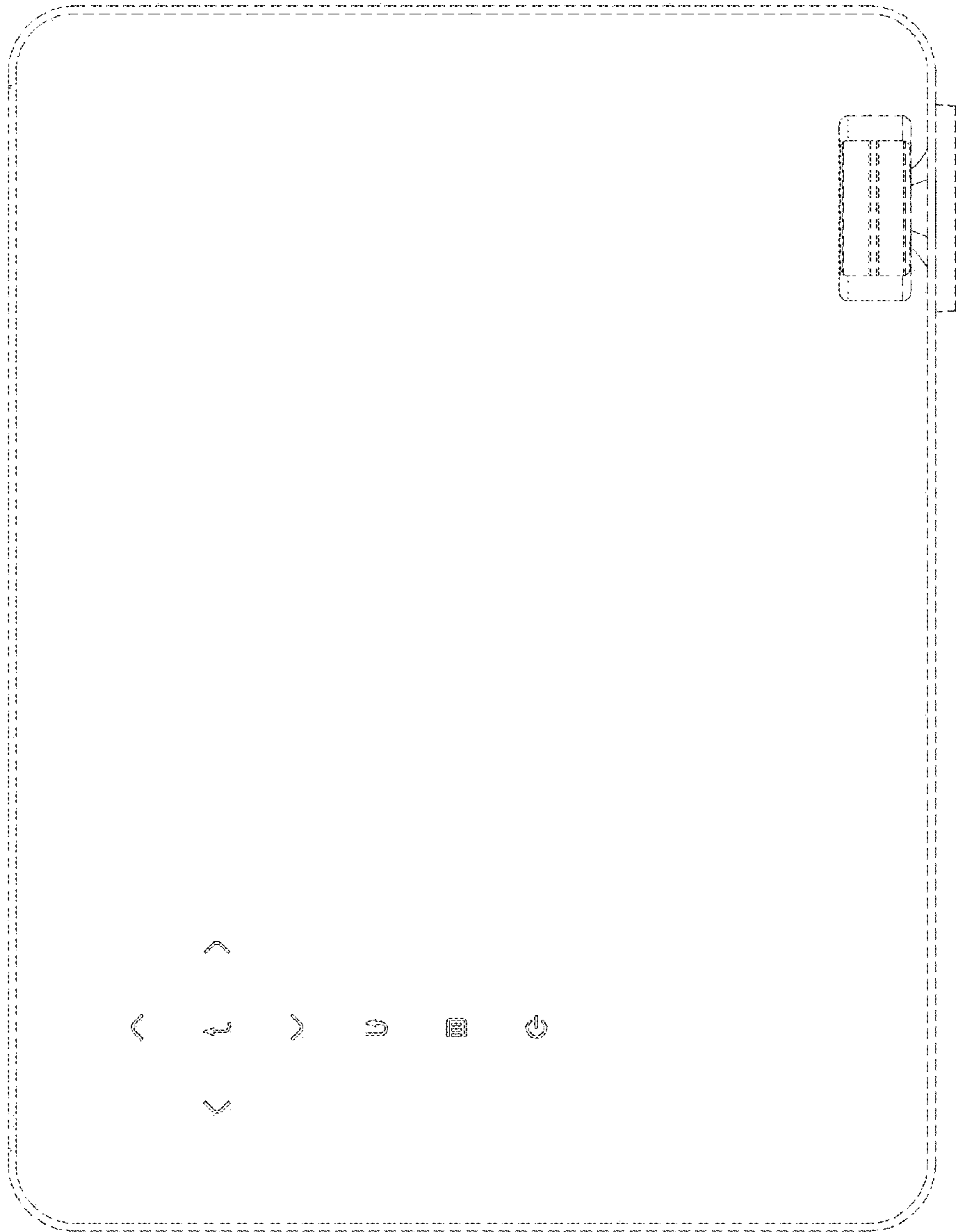

FIG. 10

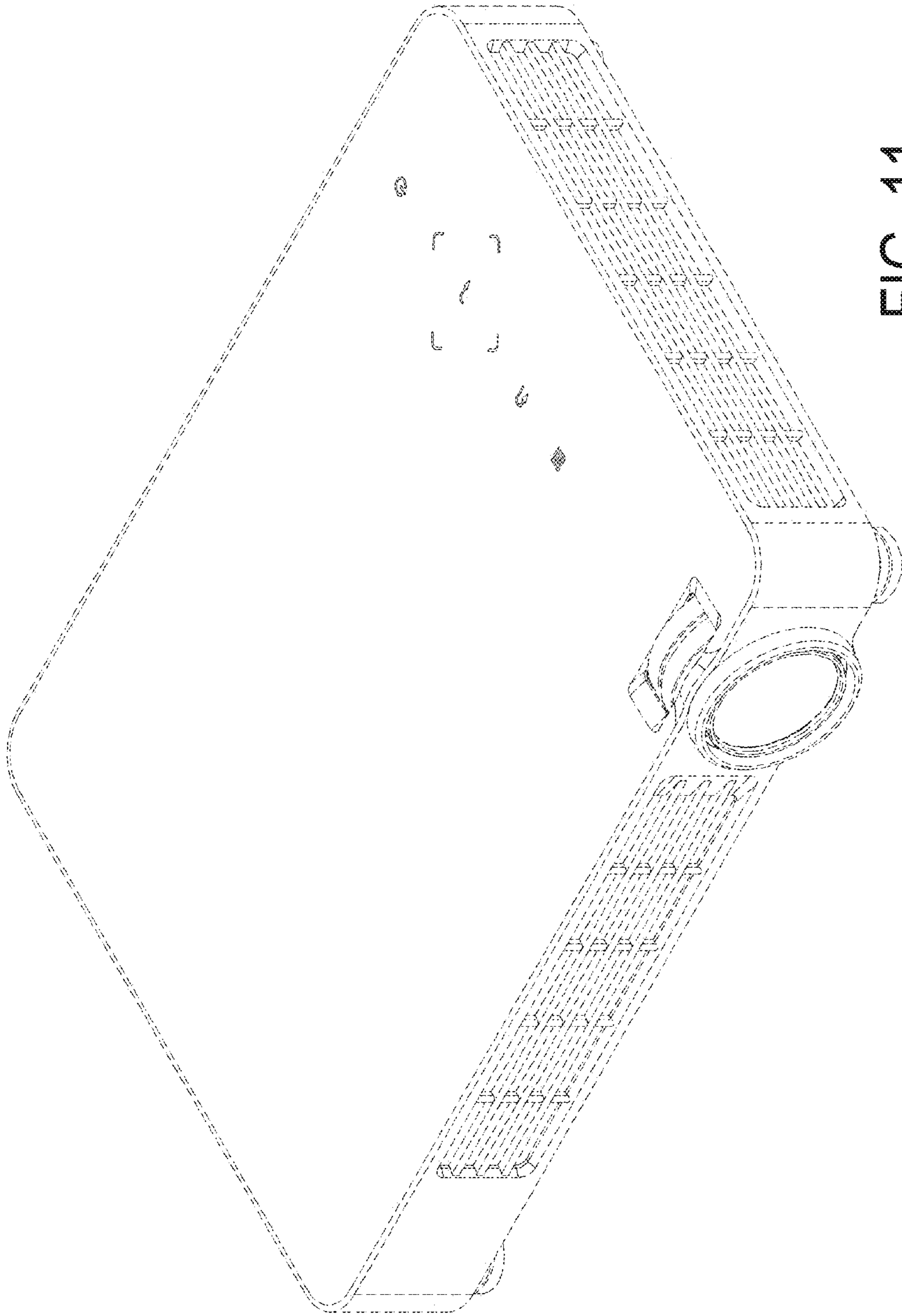

FIG. 11

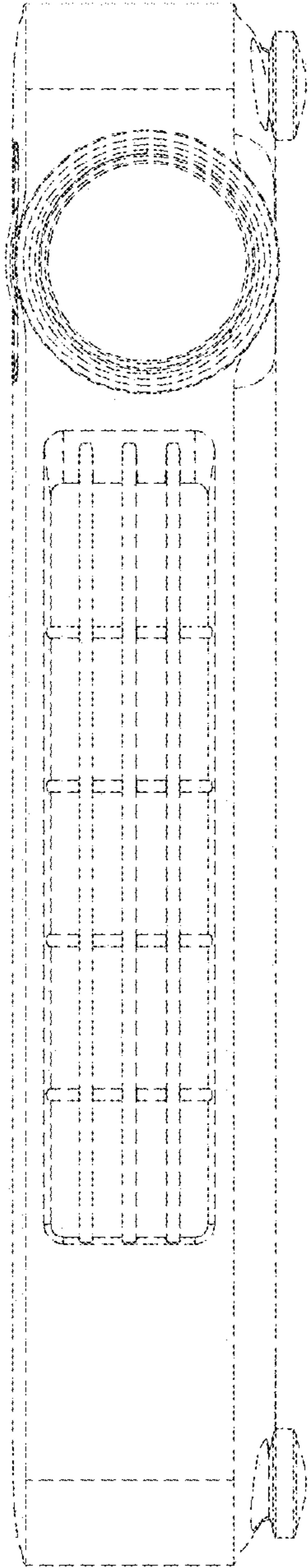

FIG. 12

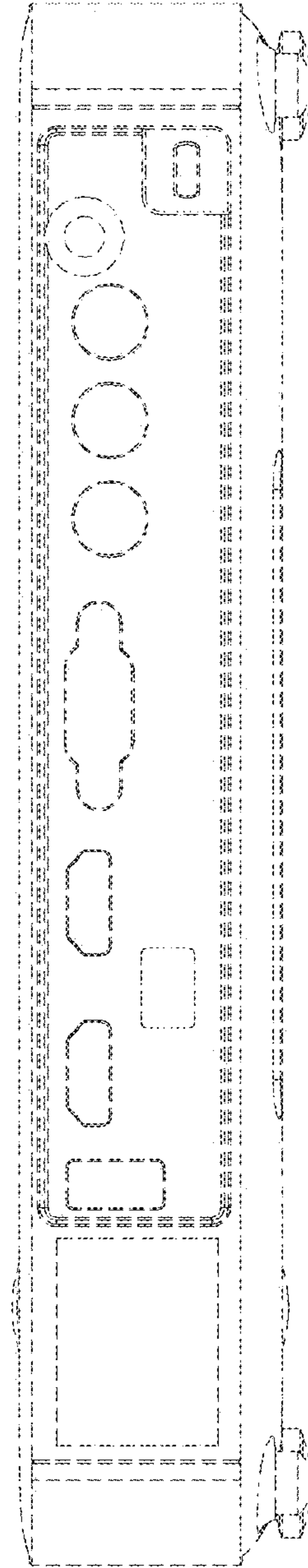

FIG. 13

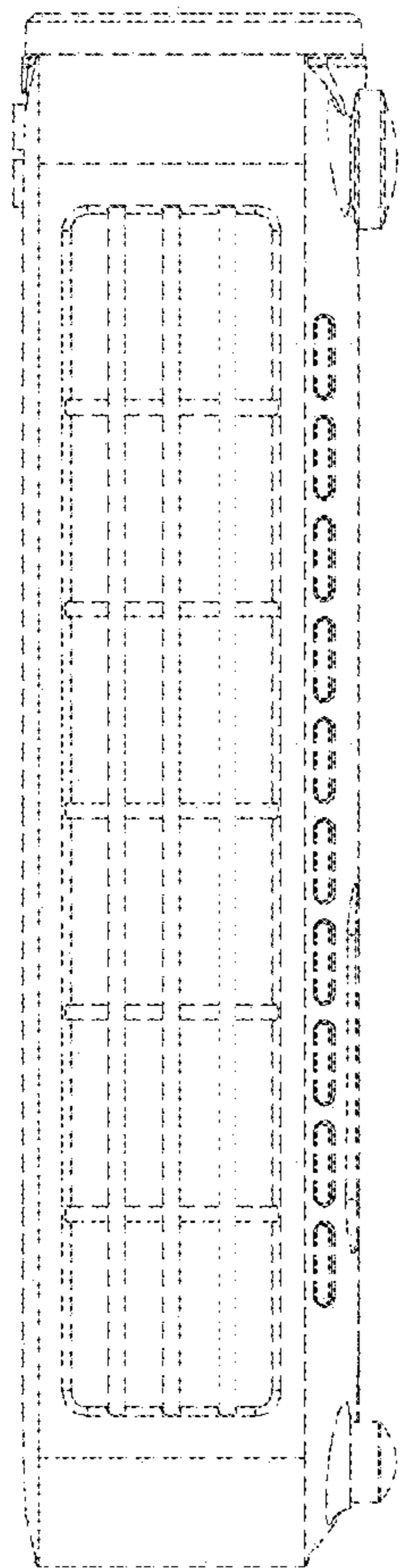

FIG. 14

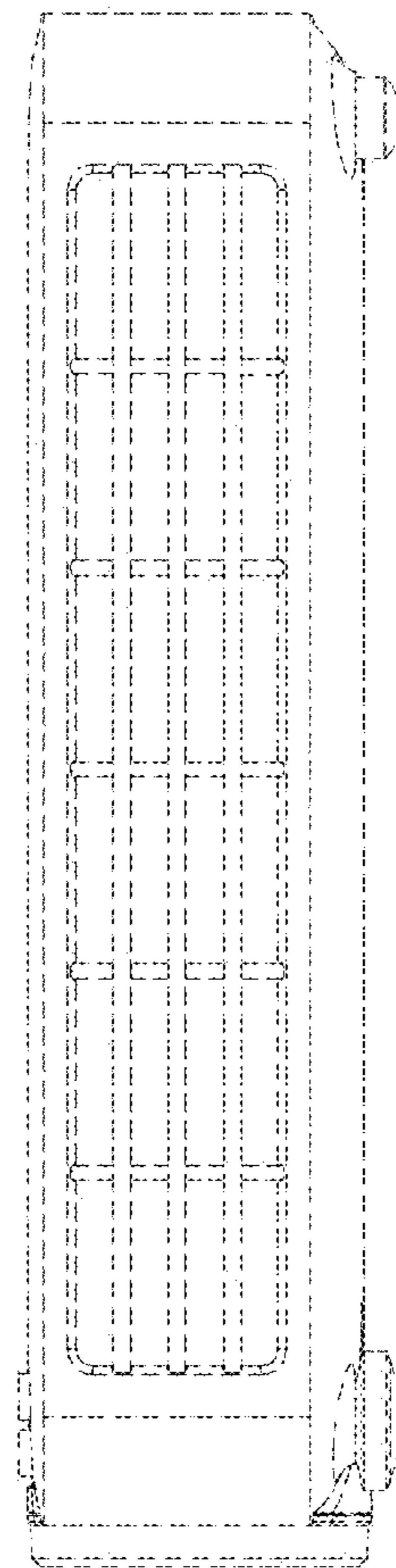

FIG. 15

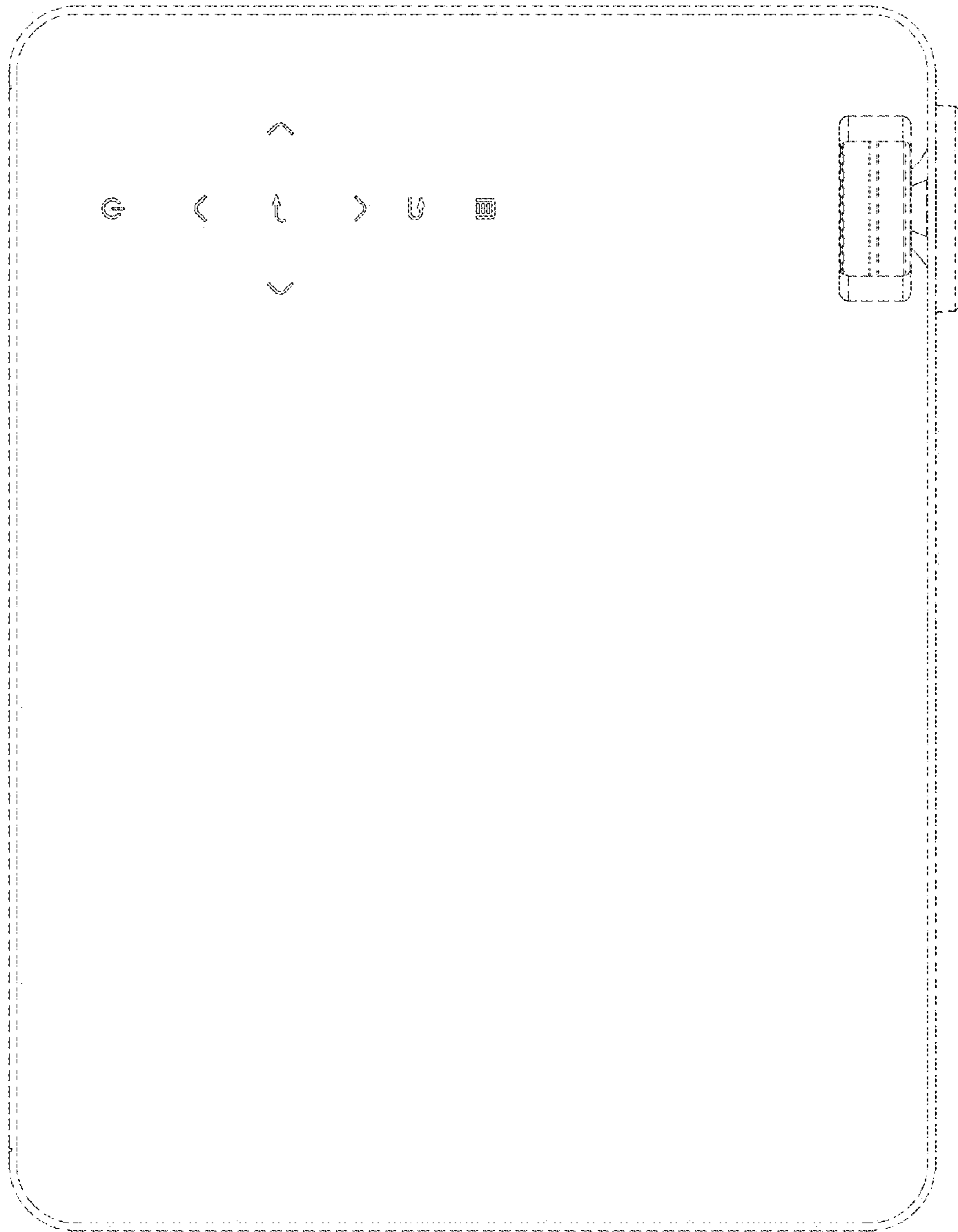

FIG. 16



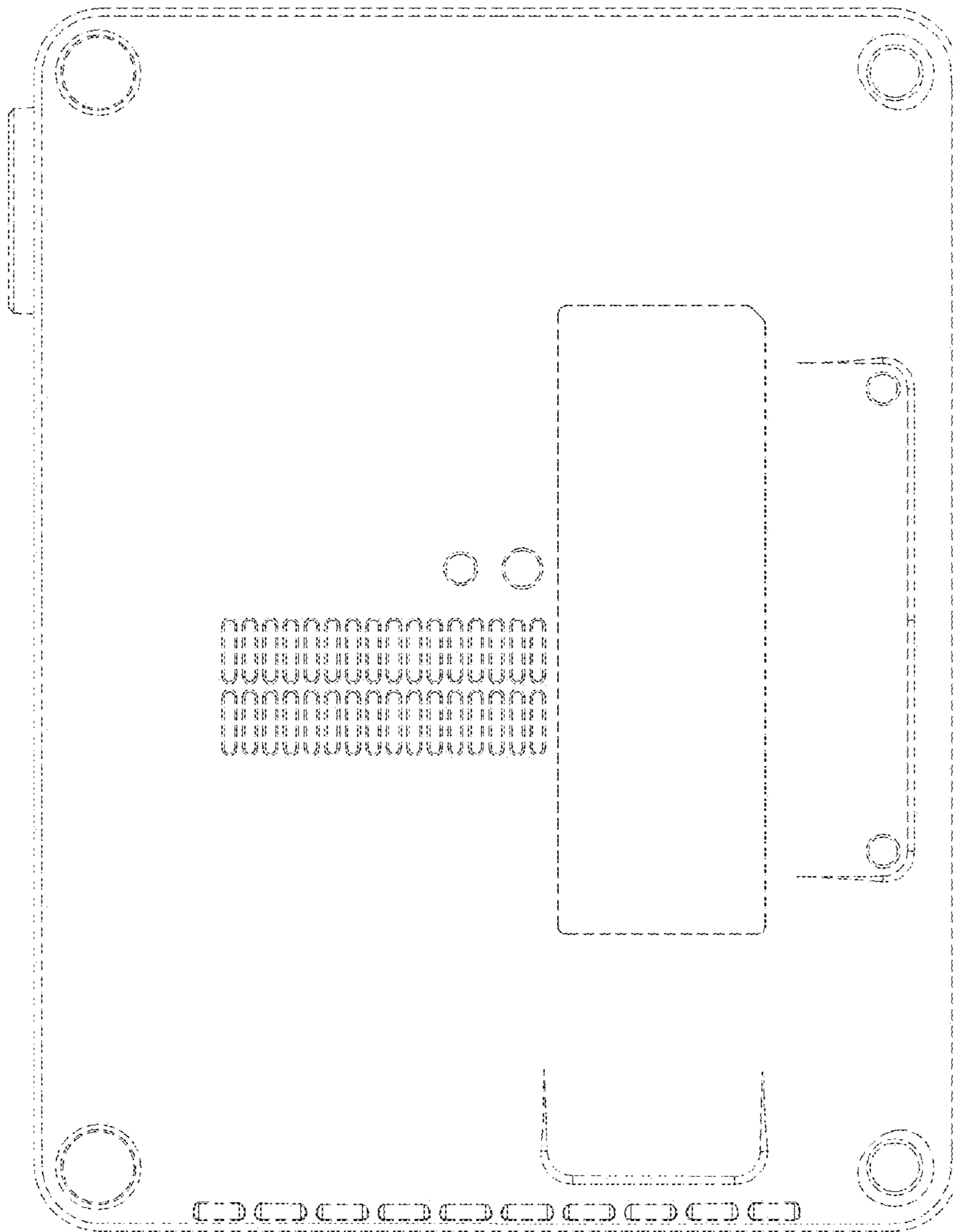

FIG. 17

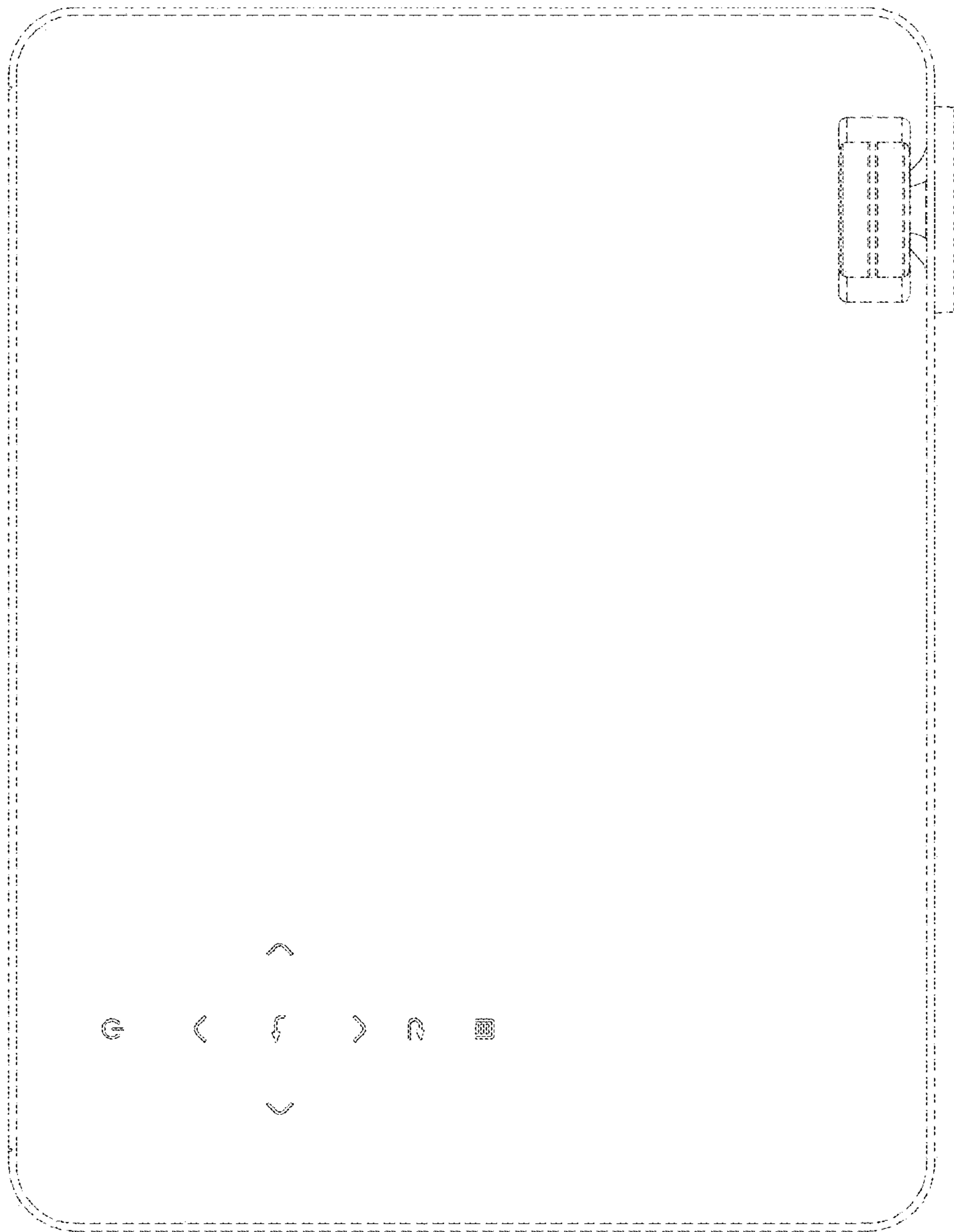

FIG. 18

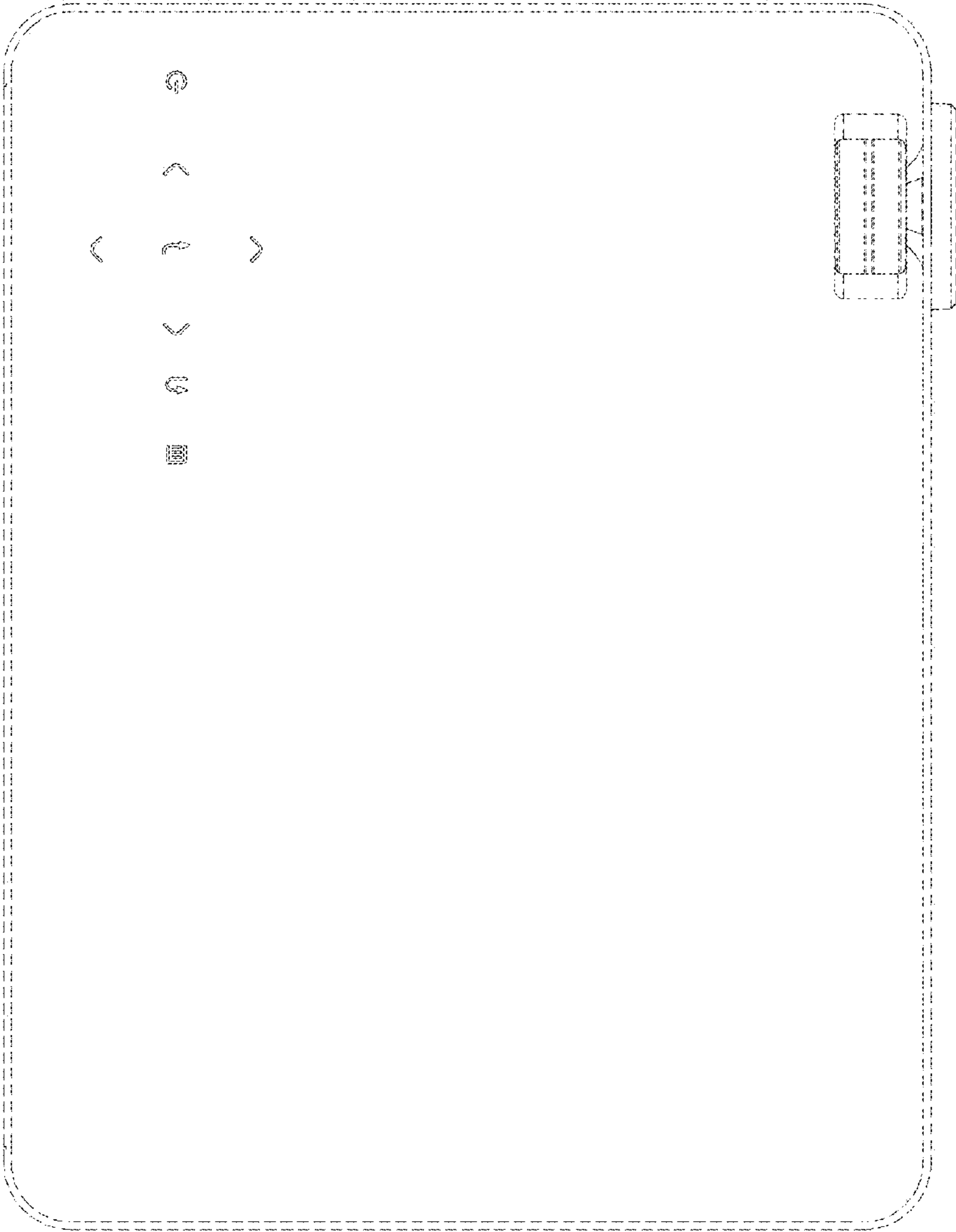

FIG. 19

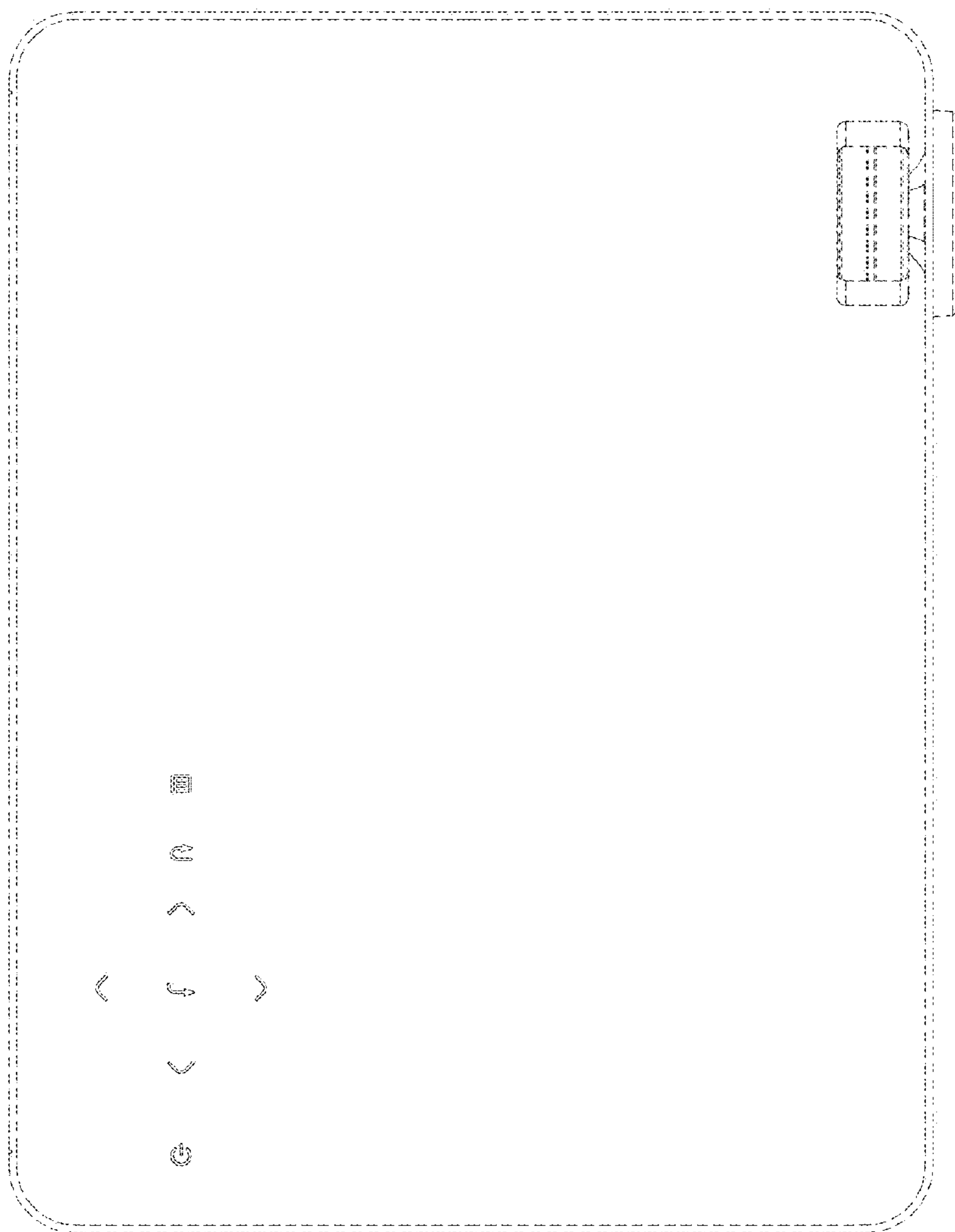

FIG. 20

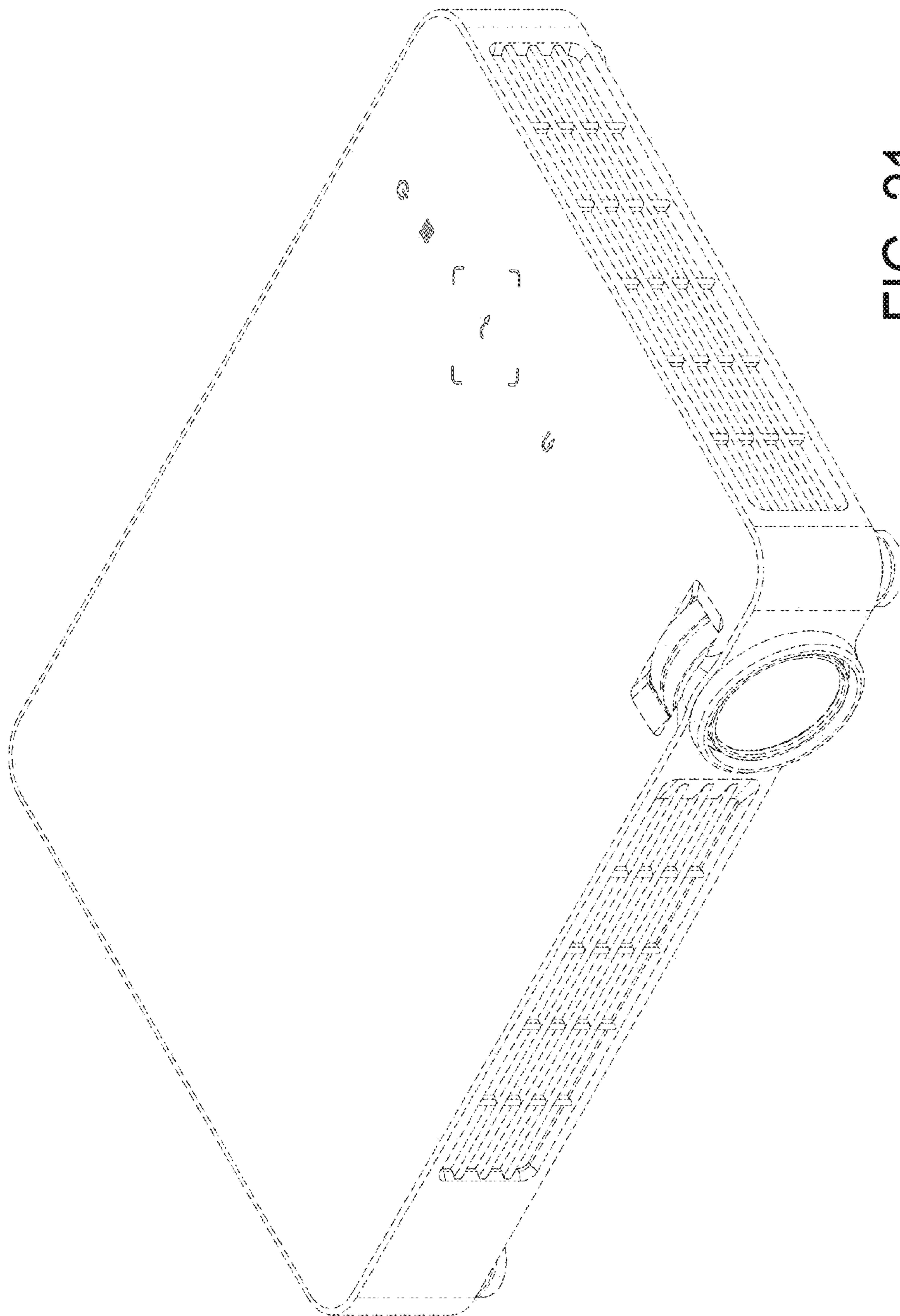

FIG. 21

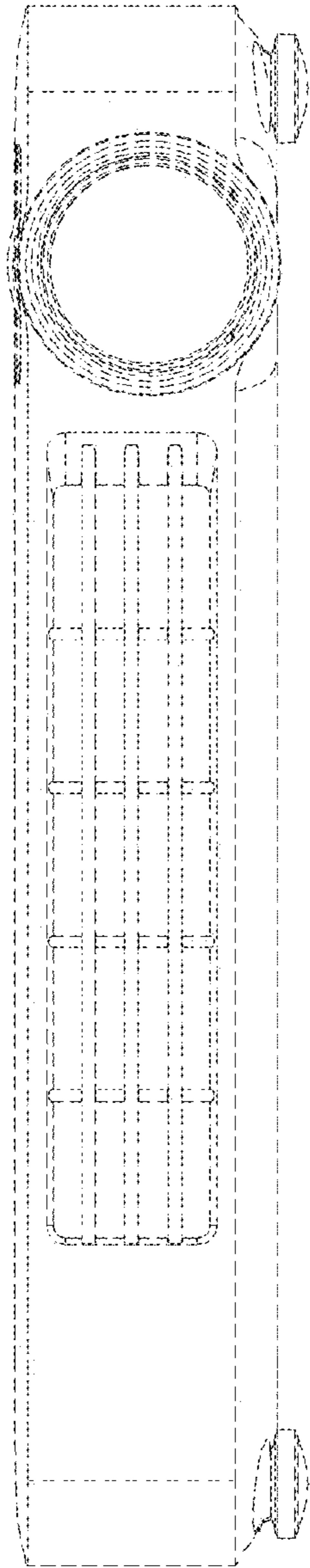

FIG. 22

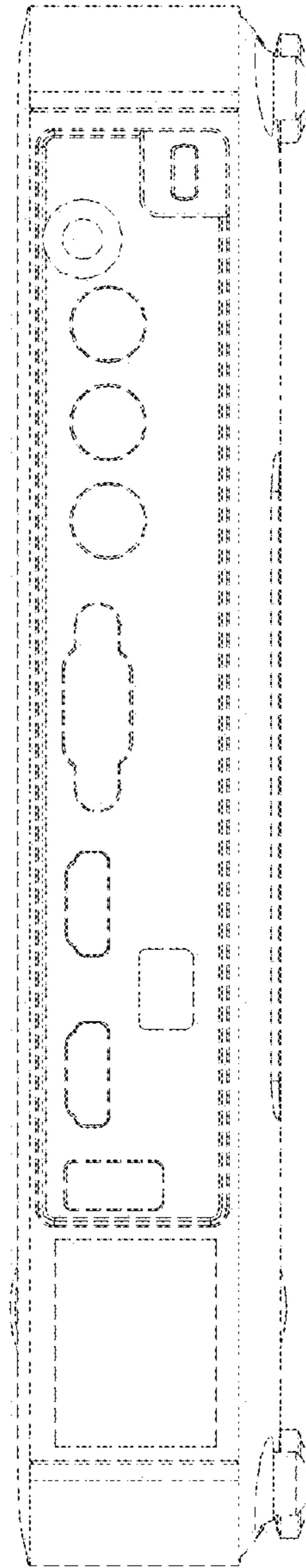

FIG. 23



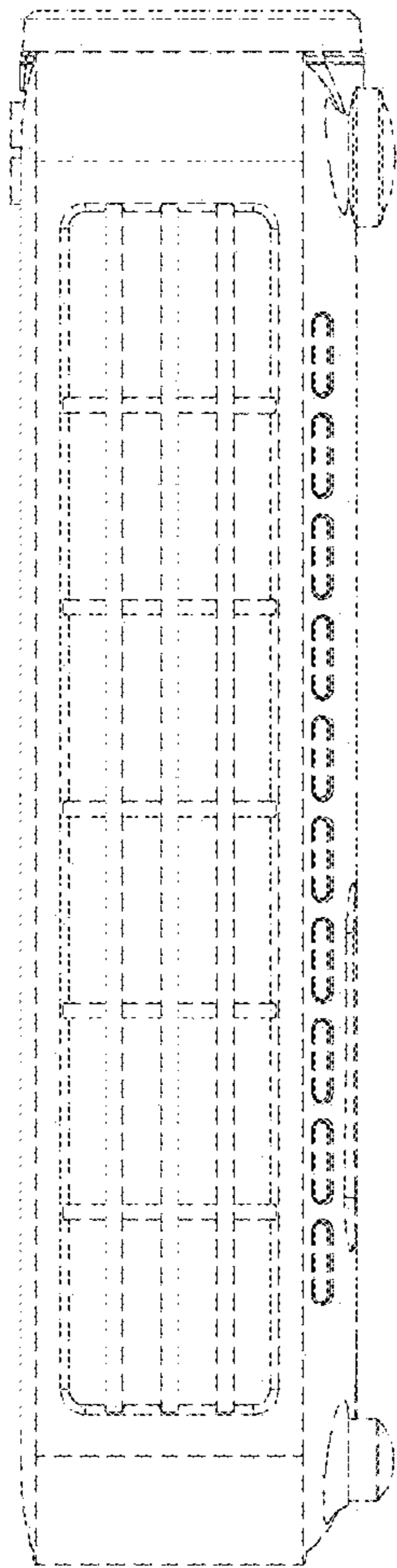

FIG. 24

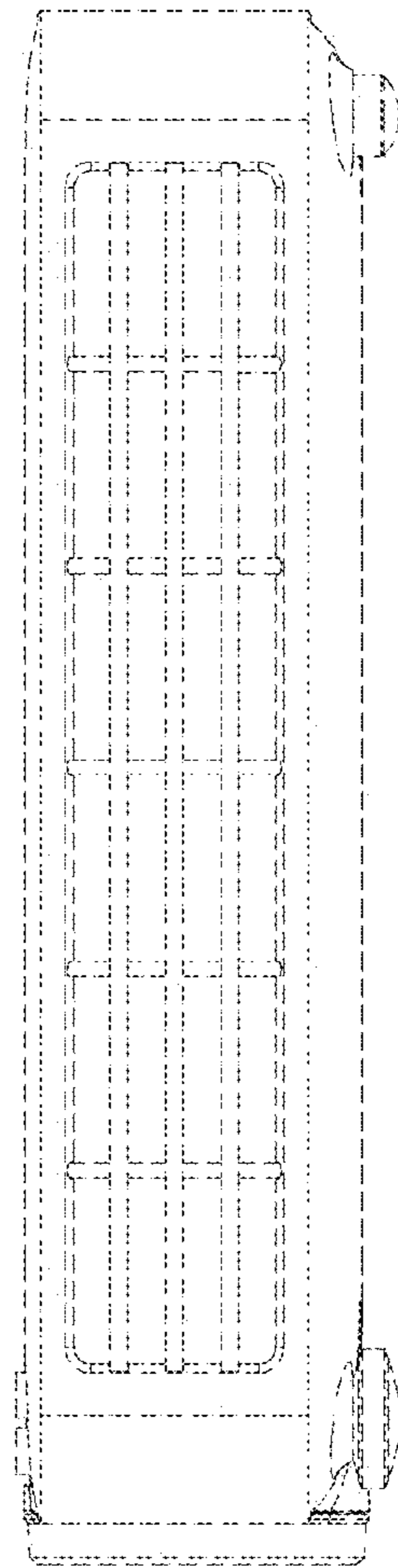

FIG. 25

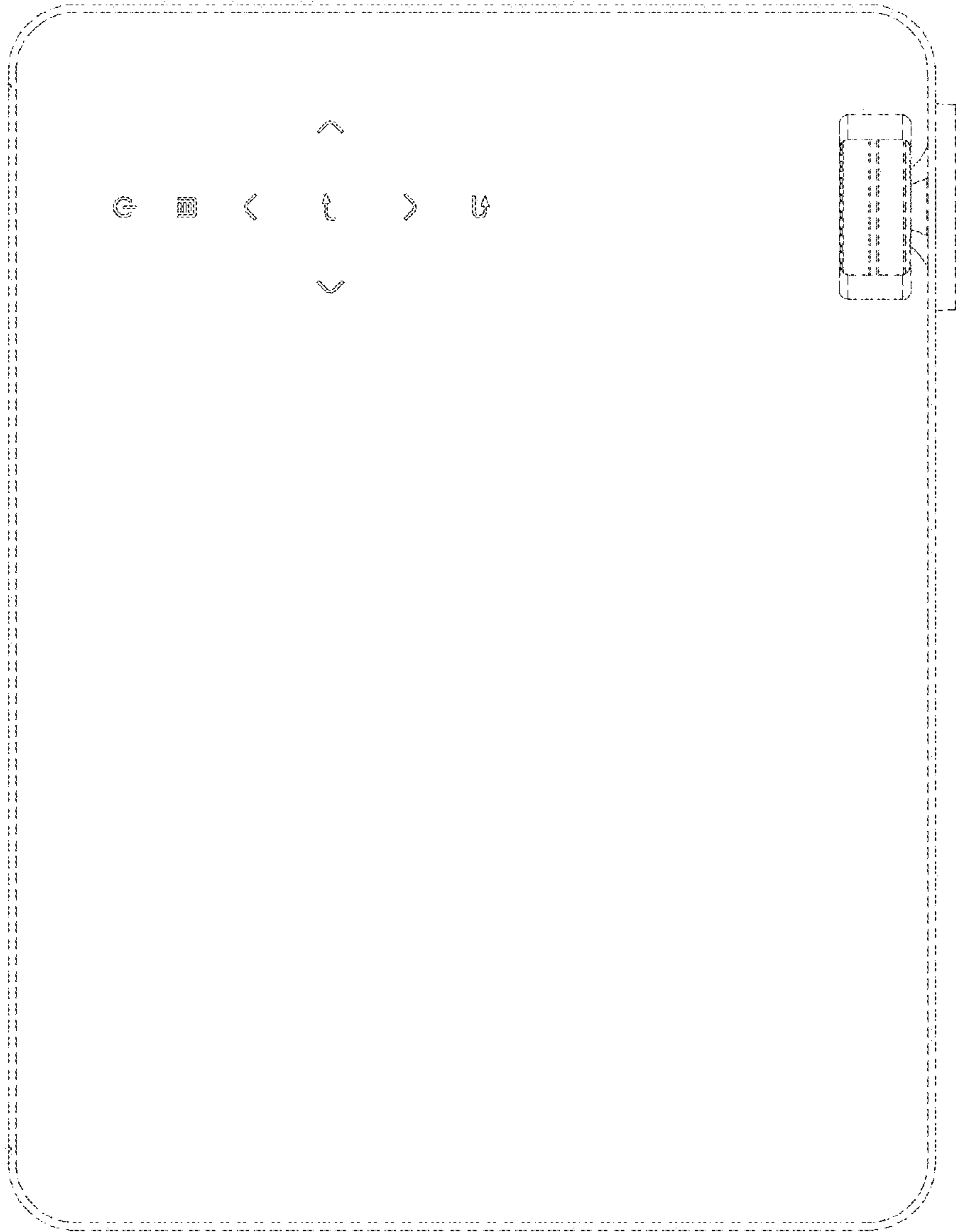

FIG. 26

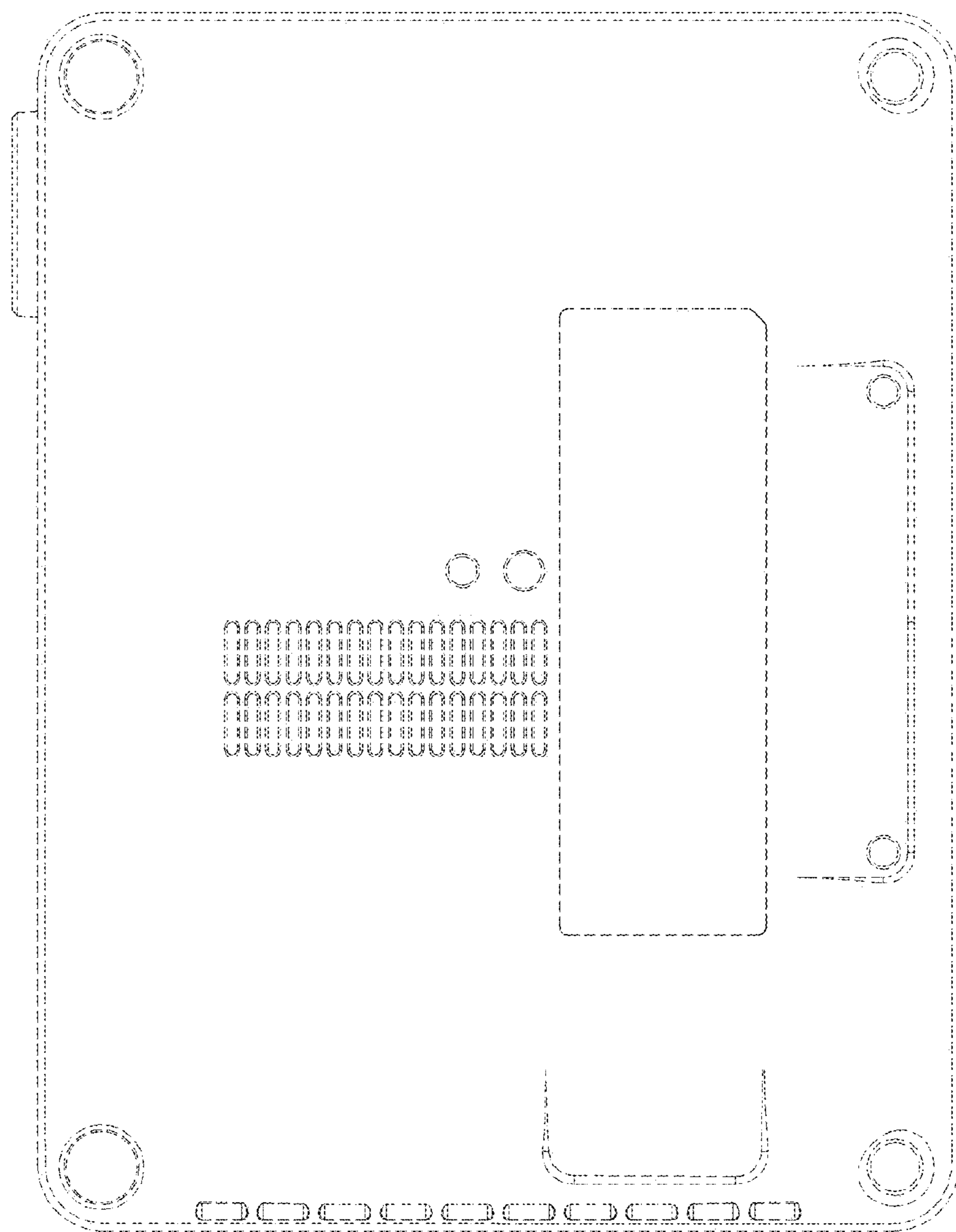

FIG. 27

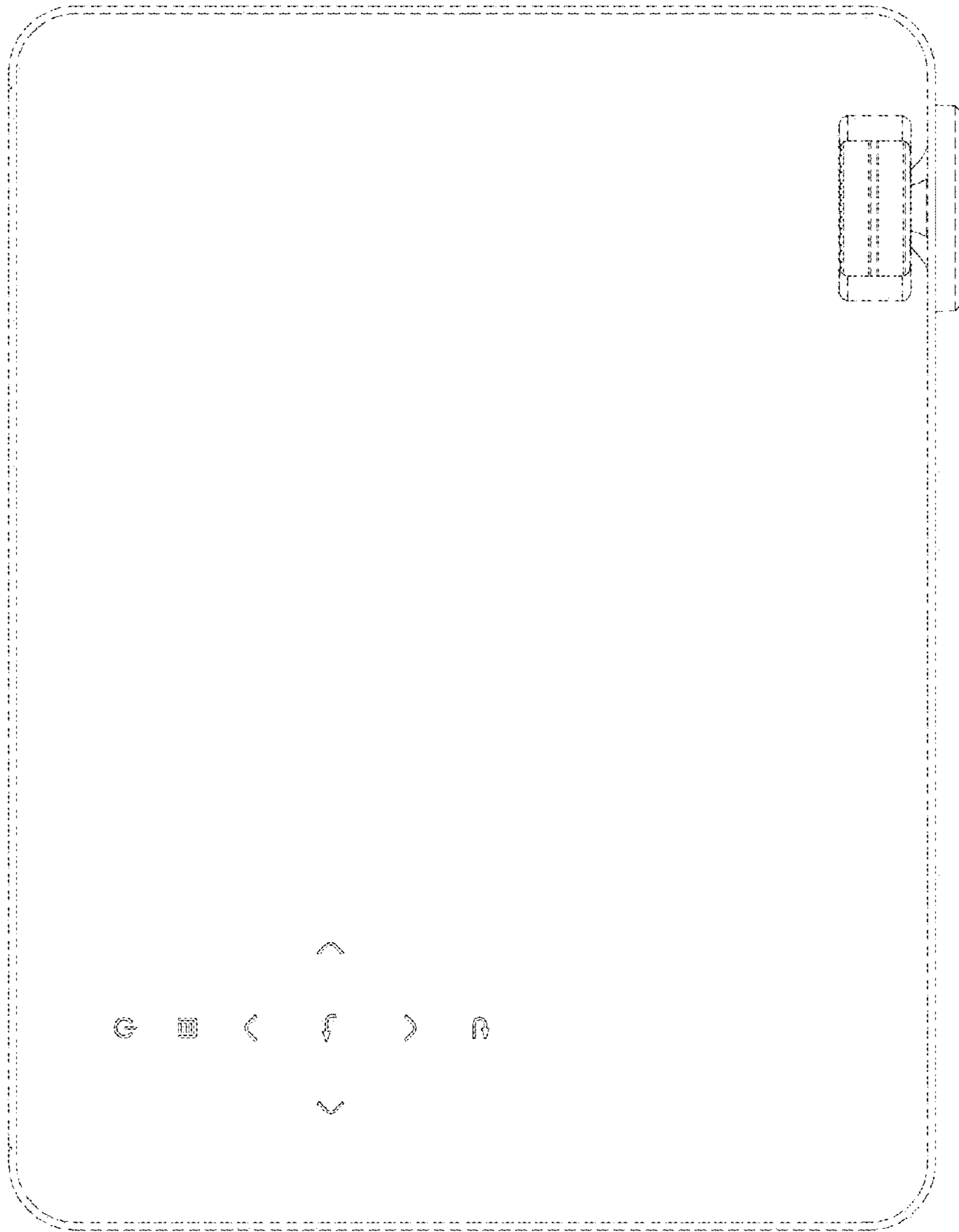

FIG. 28

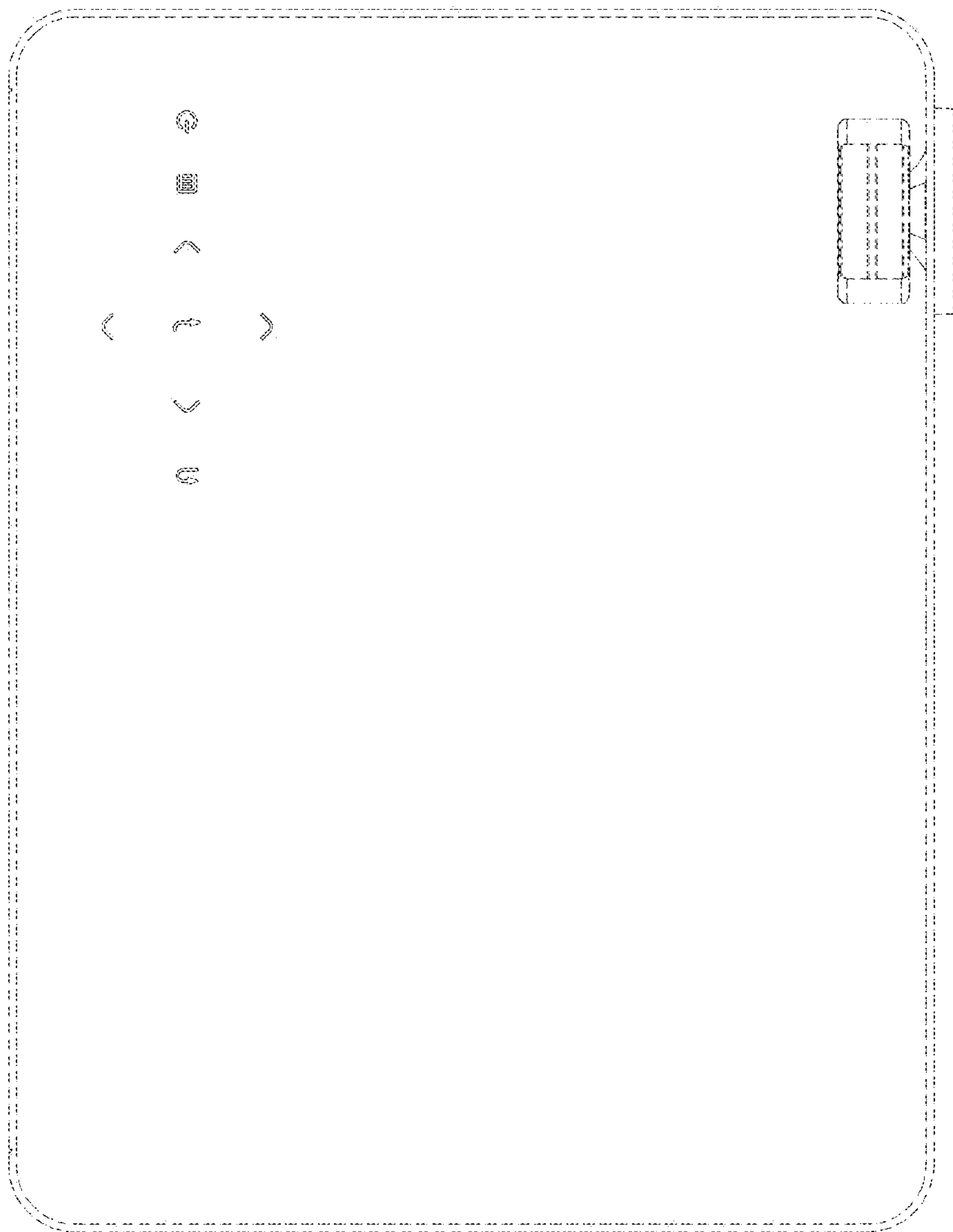

FIG. 29

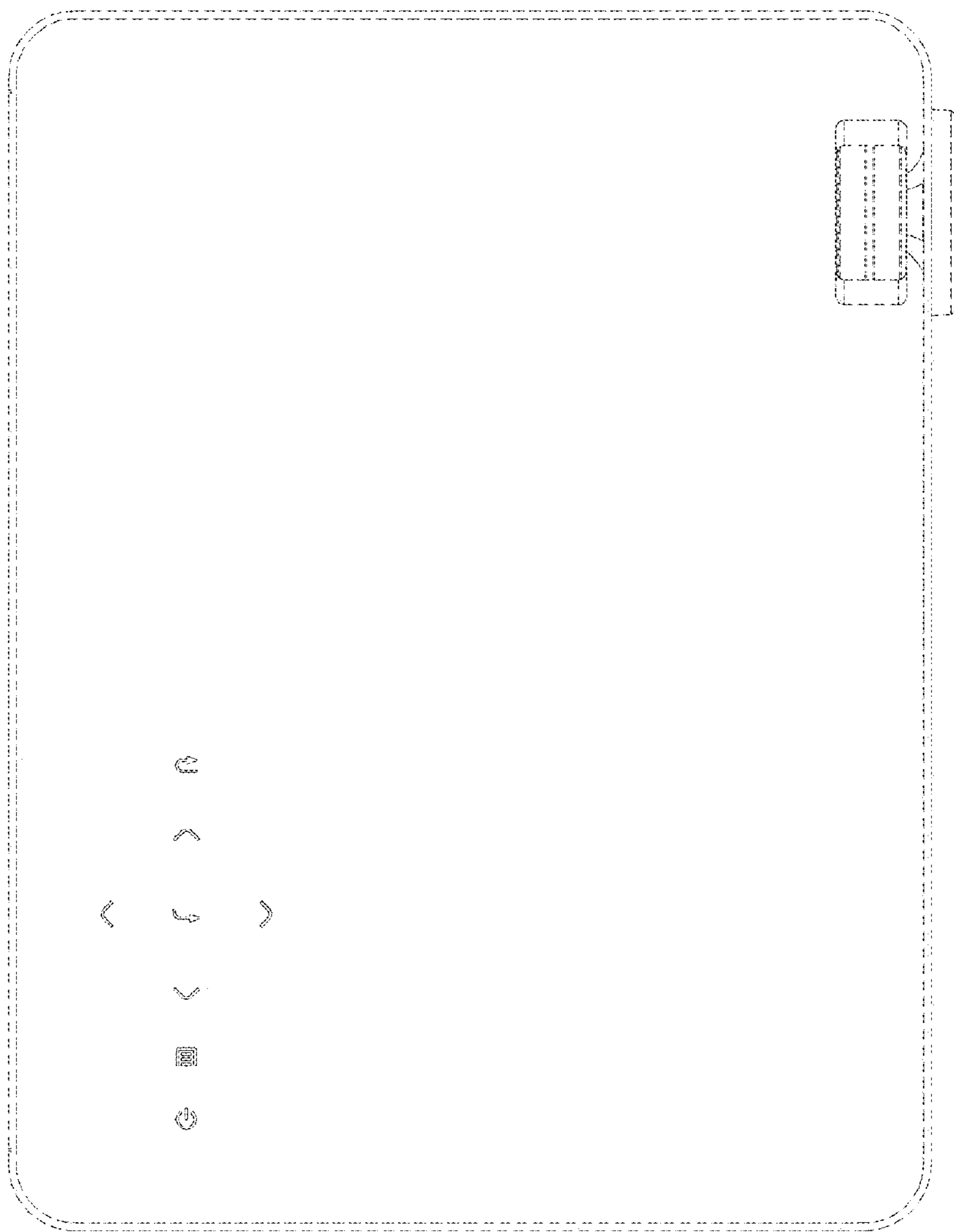

FIG. 30



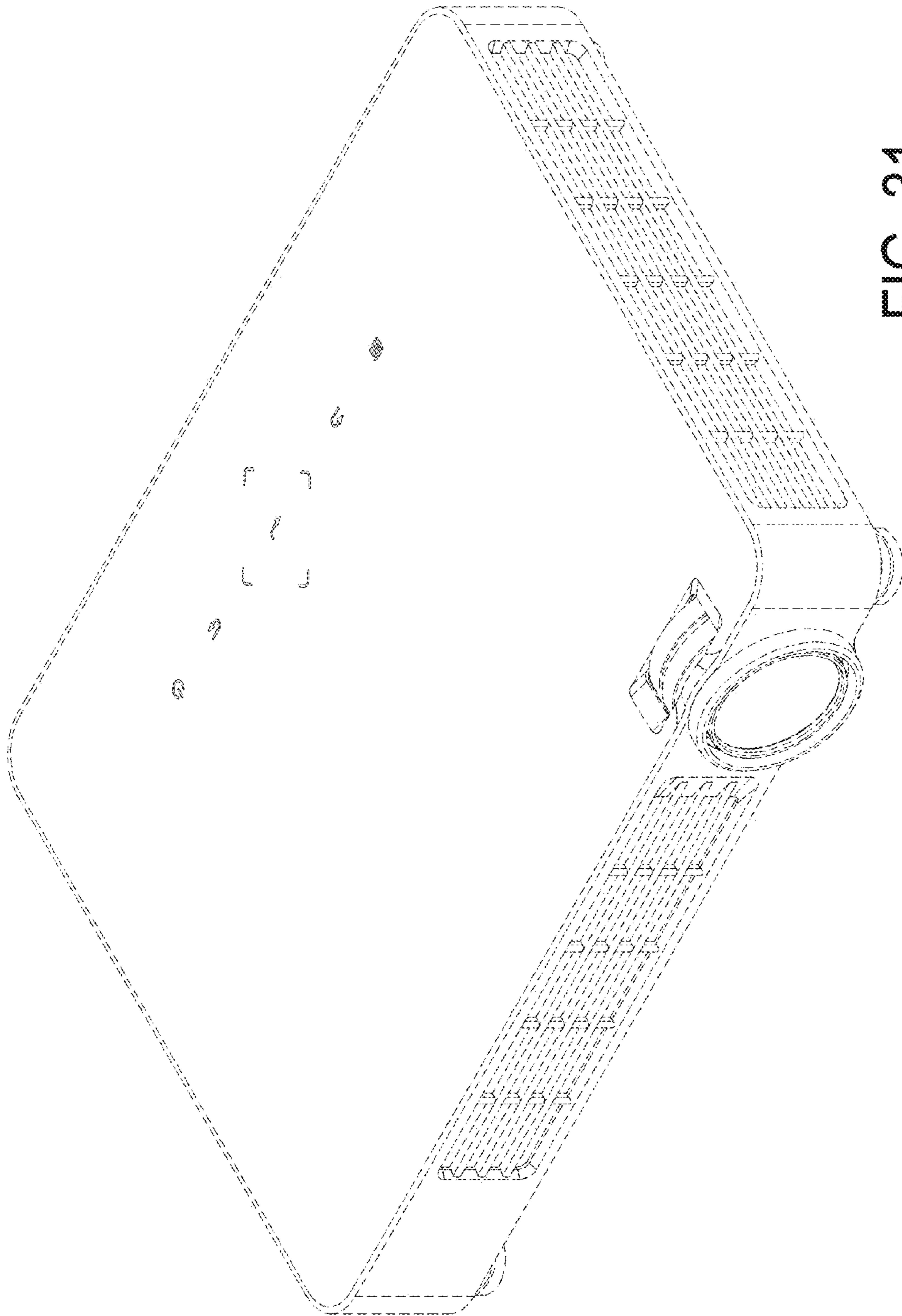

FIG. 31

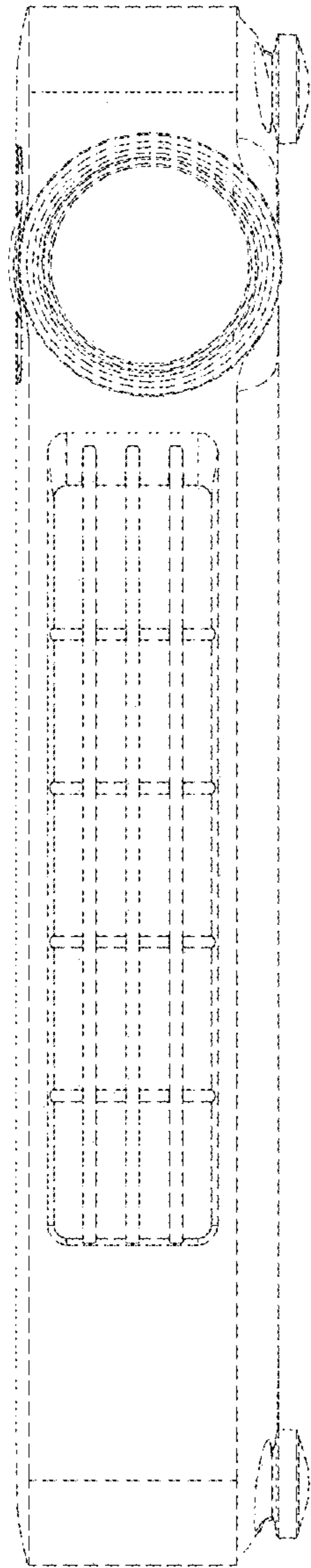

FIG. 32

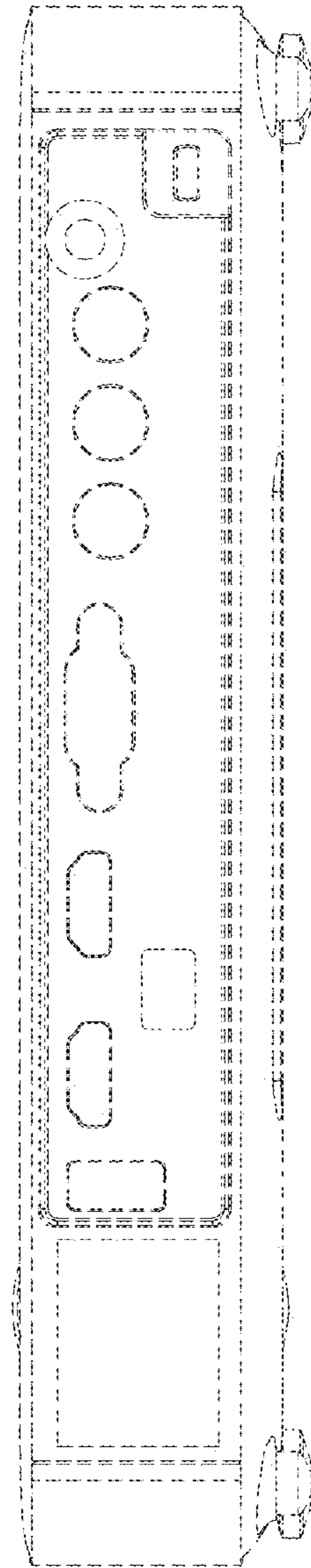

FIG. 33

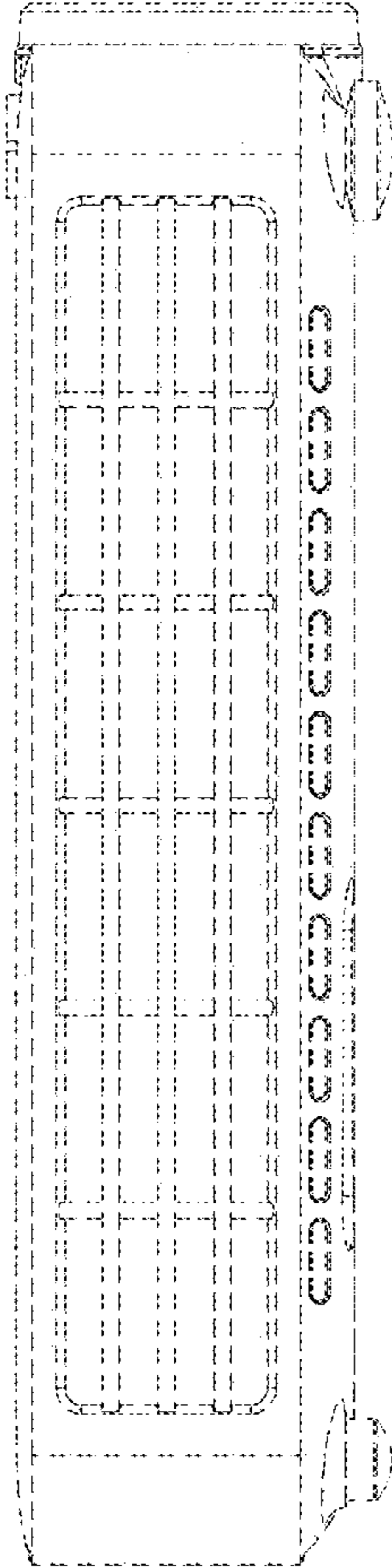

FIG. 34

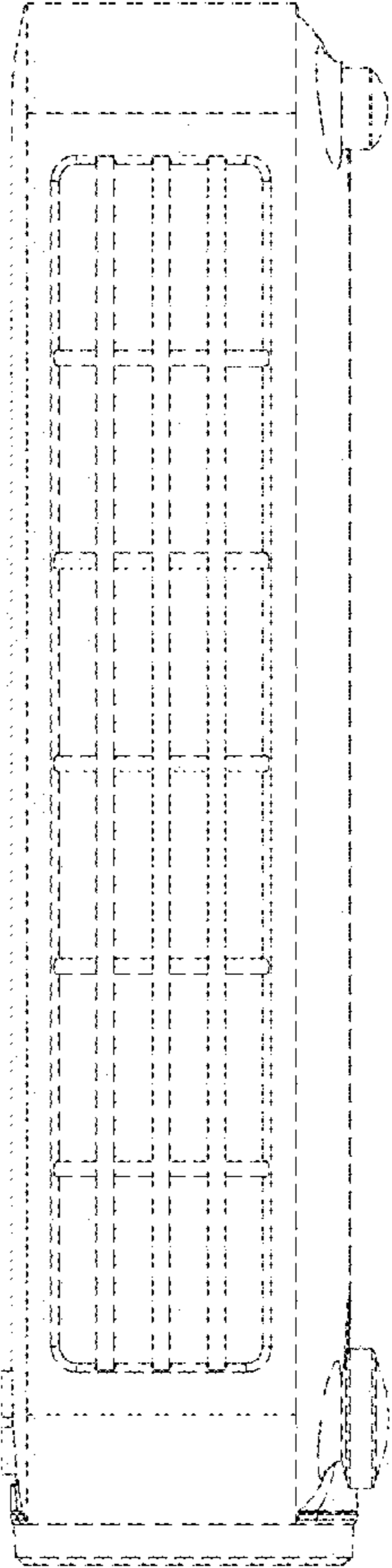

FIG. 35

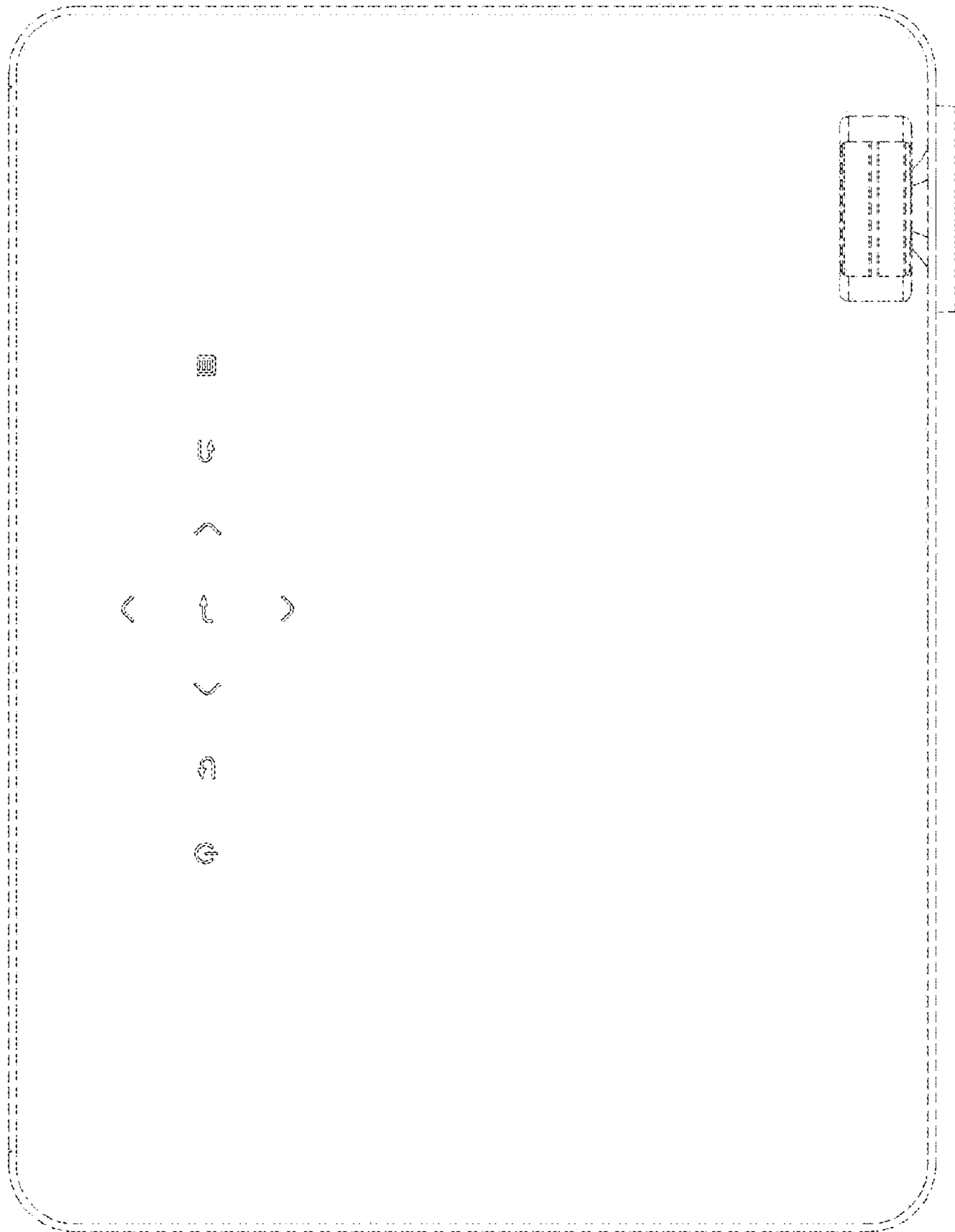

FIG. 36

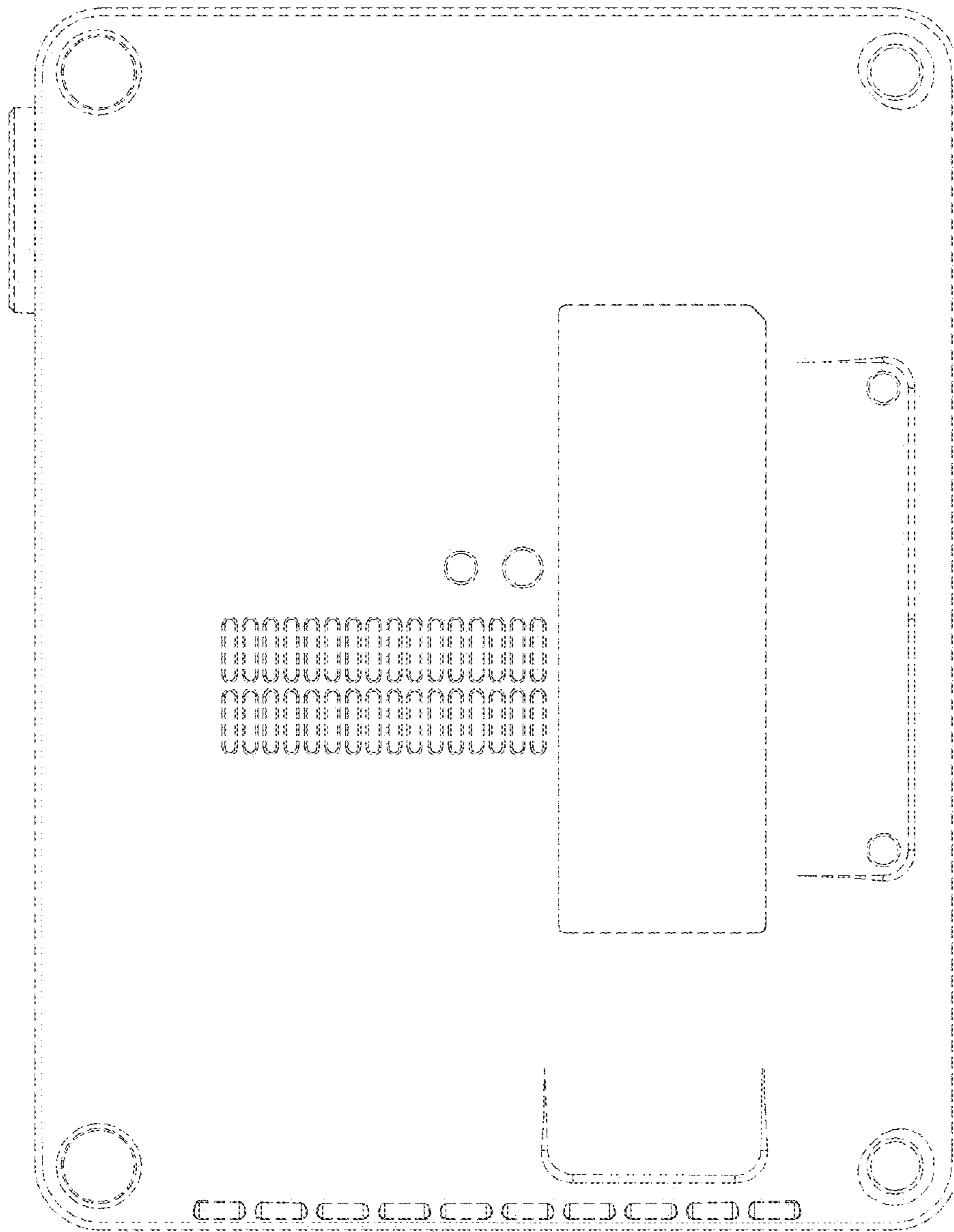

FIG. 37

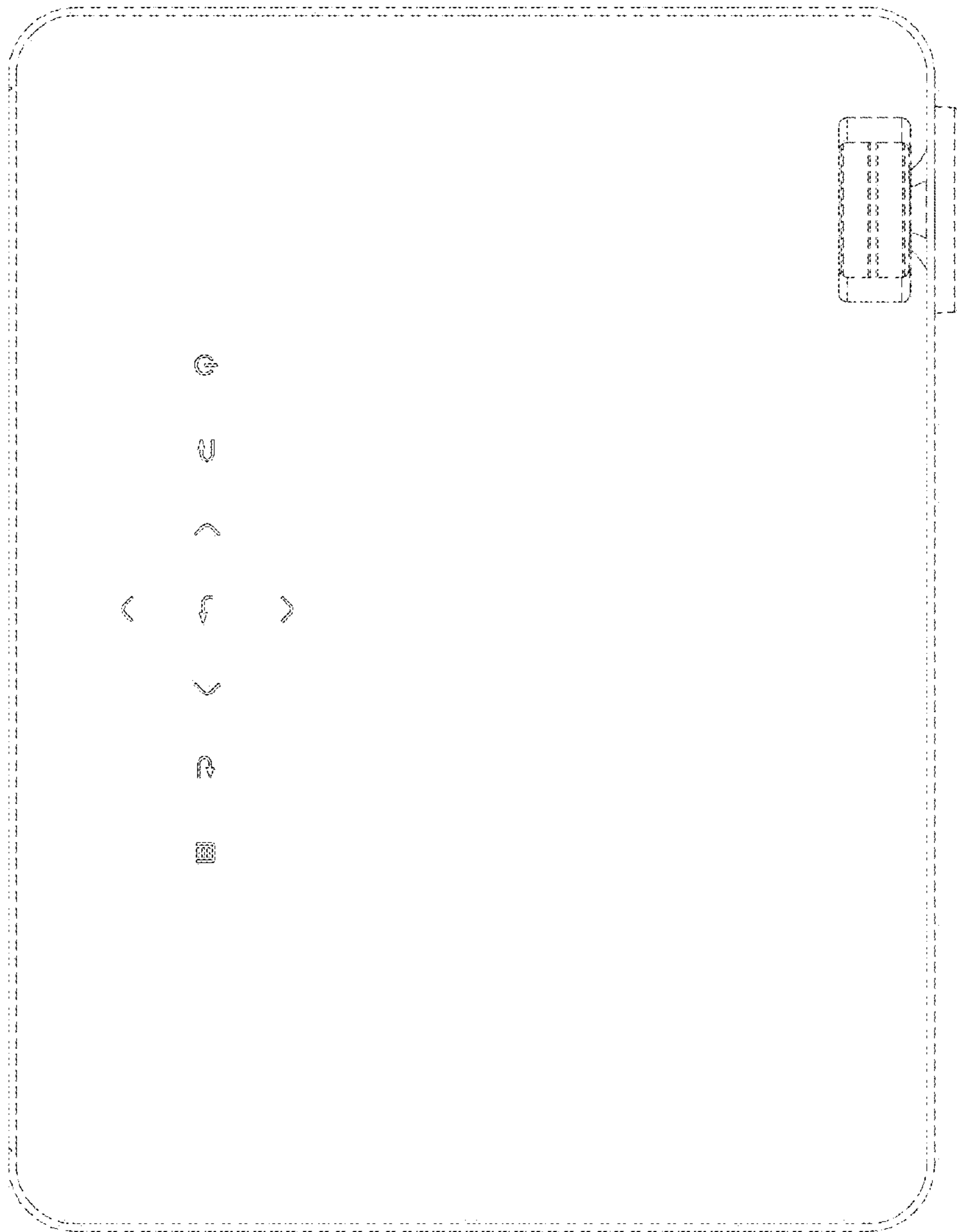

FIG. 38



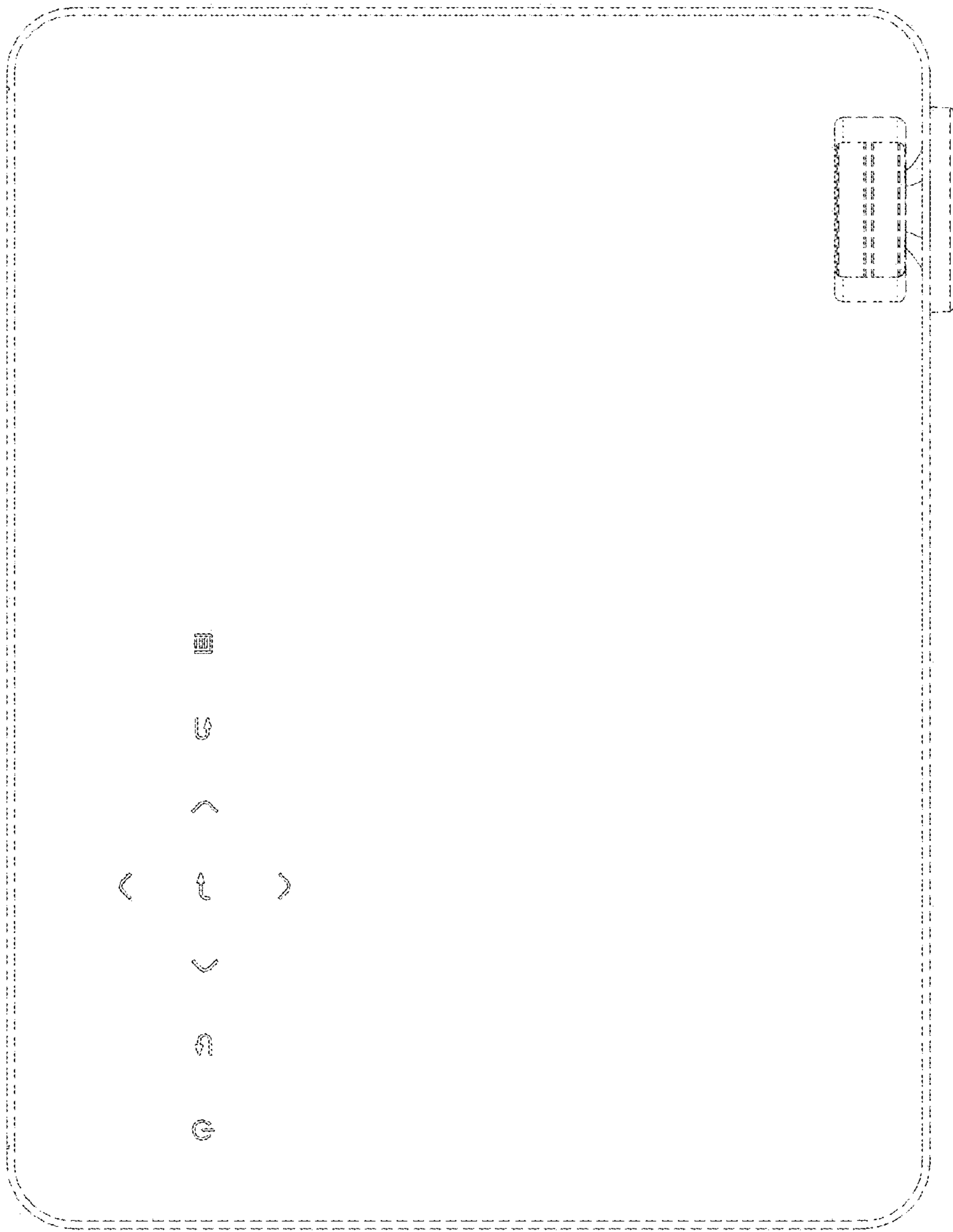

FIG. 39

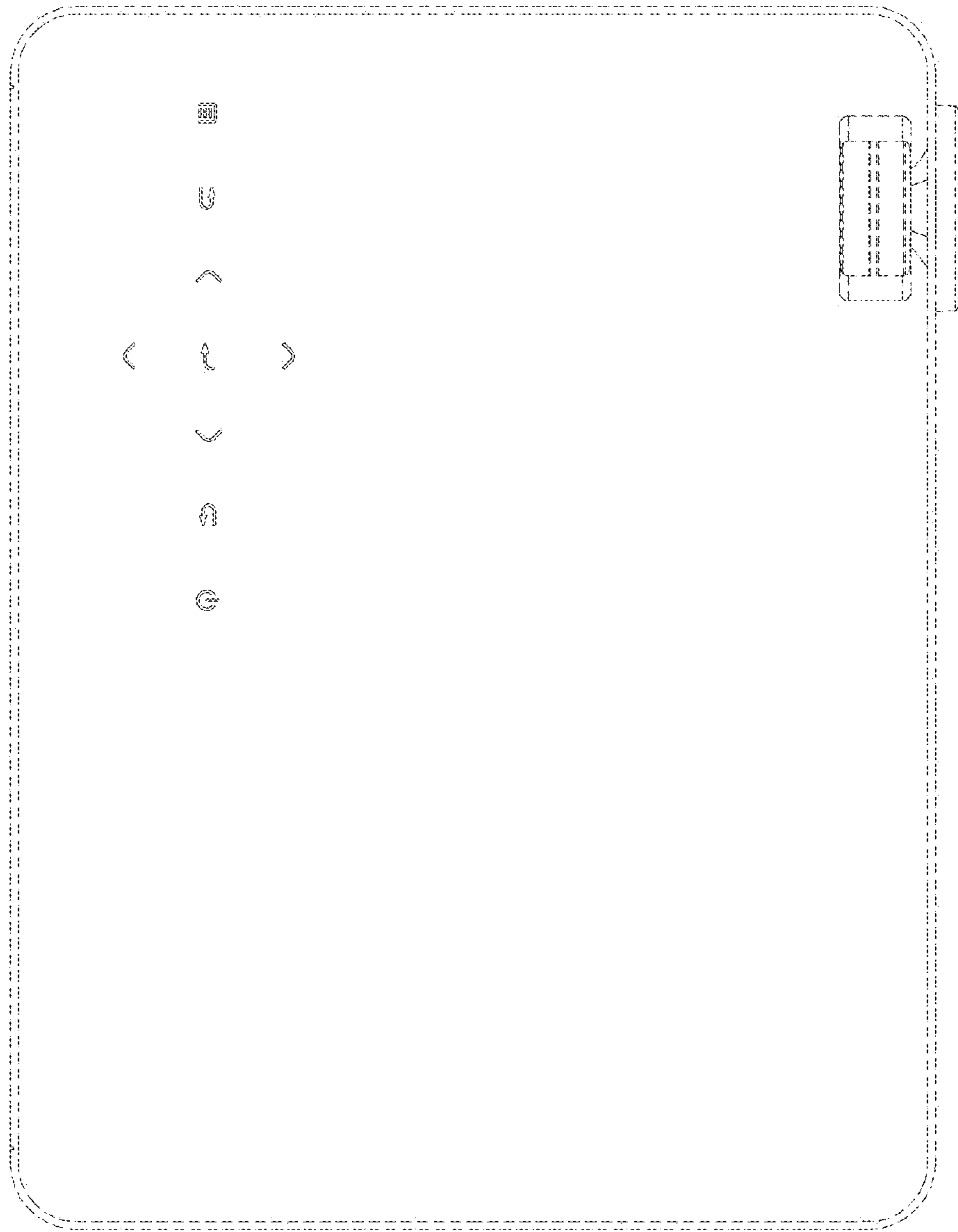

FIG. 40