



US00D709049S

(12) **United States Design Patent**
Kim

(10) **Patent No.:** **US D709,049 S**
(45) **Date of Patent:** **** Jul. 15, 2014**

(54) **AUDIO PLAYER**

(71) Applicant: **Samsung Electronics Co., Ltd.,**
Suwon-si (KR)

(72) Inventor: **Ji-Gwang Kim,** Seoul (KR)

(73) Assignee: **Samsung Electronics Co., Ltd.,**
Suwon-si (KR)

(**) Term: **14 Years**

(21) Appl. No.: **29/449,526**

(22) Filed: **Mar. 15, 2013**

(30) **Foreign Application Priority Data**

Oct. 23, 2012 (KR) 30-2012-0050269

(51) **LOC (10) Cl.** **14-03**

(52) **U.S. Cl.**
USPC **D14/203.1; D14/209.1; D14/496**

(58) **Field of Classification Search**
USPC D14/496, 401, 435, 474, 483, 217, 137,
D14/138, 160, 168, 356, 203.1–203.8, 507,
D14/209.1, 204, 210–216; 345/156, 169,
345/173–179, 905; 715/727–729, 864;
710/1, 5, 8; 713/1, 600; 455/1.1, 1.7,
455/73, 344–347, 93, 95, 3.01–3.06, 550.1,
455/573.1; 370/342–344; 369/1, 2, 6–12;
463/43–47; 273/148 B; 181/143, 144,
181/147, 148, 150–153, 157, 198, 199;
381/300–303, 306, 332, 333, 336, 345,
381/361–354, 386–388

See application file for complete search history.

(56) **References Cited**

U.S. PATENT DOCUMENTS

4,966,164 A * 10/1990 Colsen et al. 607/72
6,285,867 B1 * 9/2001 Boling et al. 455/404.1
6,668,407 B1 * 12/2003 Reitzel 5/656
D514,122 S * 1/2006 Rodarte D14/203.6

D527,704 S * 9/2006 Rodarte D13/108
D560,211 S * 1/2008 Kim et al. D14/216
7,395,090 B2 * 7/2008 Alden 455/557
D582,394 S * 12/2008 Hong et al. D14/216
D595,734 S * 7/2009 Son D14/496
D596,159 S * 7/2009 Yamaji et al. D14/216
D612,361 S * 3/2010 Wright D14/203.2
D642,157 S * 7/2011 Holzer D14/209.1
D699,217 S * 2/2014 McCoy D14/207

* cited by examiner

Primary Examiner — Prabhakar Deshmukh

(74) *Attorney, Agent, or Firm* — NSIP Law

(57) **CLAIM**

The ornamental design for an audio player, as shown and described.

DESCRIPTION

FIG. 1 is a perspective view of an audio player showing my new design;

FIG. 2 is a front elevation thereof;

FIG. 3 is a rear elevation thereof;

FIG. 4 is a left side elevation thereof;

FIG. 5 is a right side elevation thereof;

FIG. 6 is a top plan view thereof;

FIG. 7 is a bottom plan view thereof;

FIG. 8 is a left side elevation thereof, shown in environmental use;

FIG. 9 is a rear perspective view thereof;

FIG. 10 is a bottom perspective view thereof;

FIG. 11 is a front elevation thereof, shown in environmental use;

FIG. 12 is a rear elevation thereof, shown in another environmental use; and,

FIG. 13 is a top plan view thereof, shown in another environmental use.

The broken lines in FIGS. 8, 11, 12, and 13 indicate environment and form no part of the claimed design. Other broken lines throughout the drawing indicate unclaimed portions and form no part of the claimed design.

1 Claim, 13 Drawing Sheets

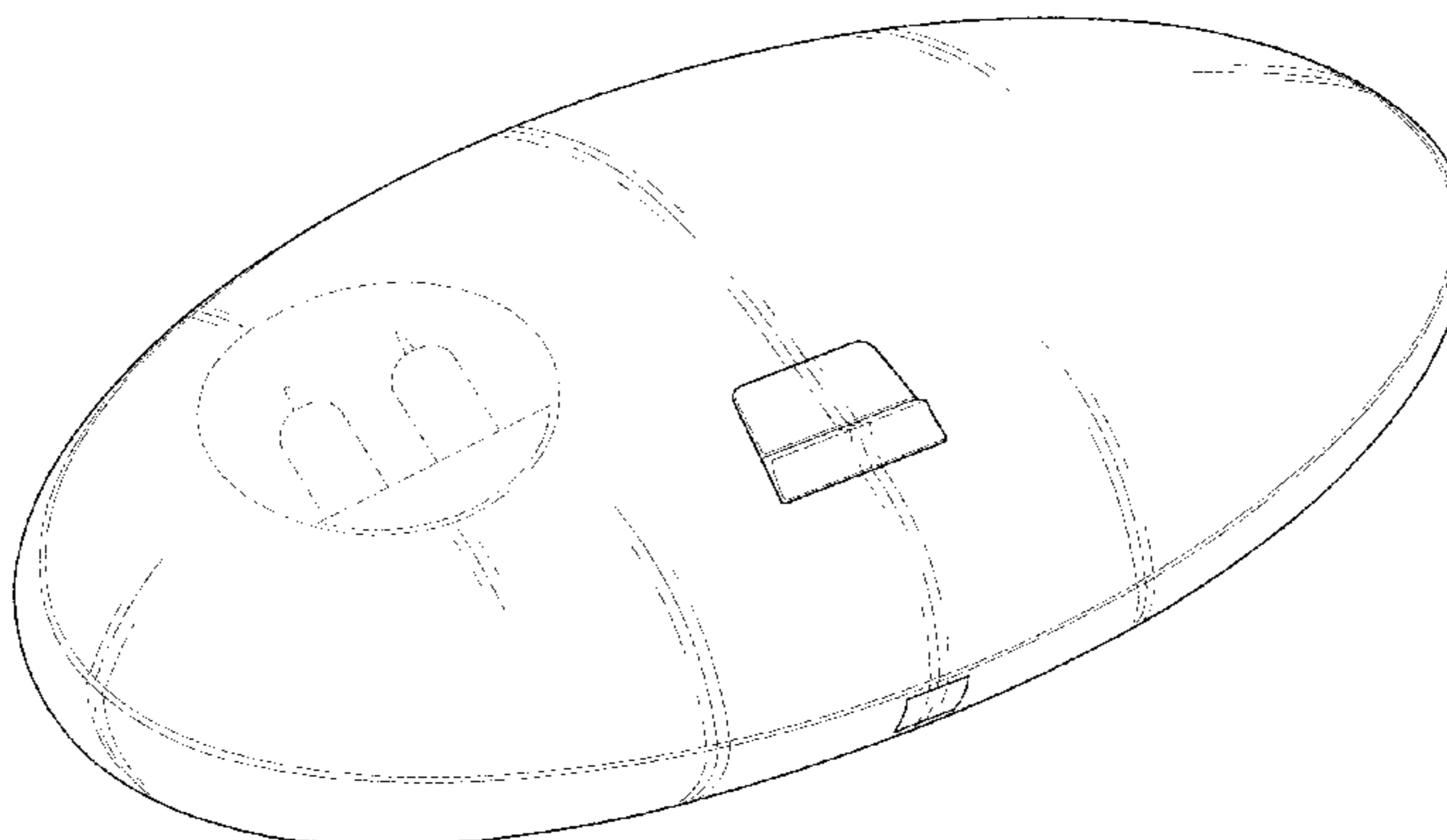

FIG. 1

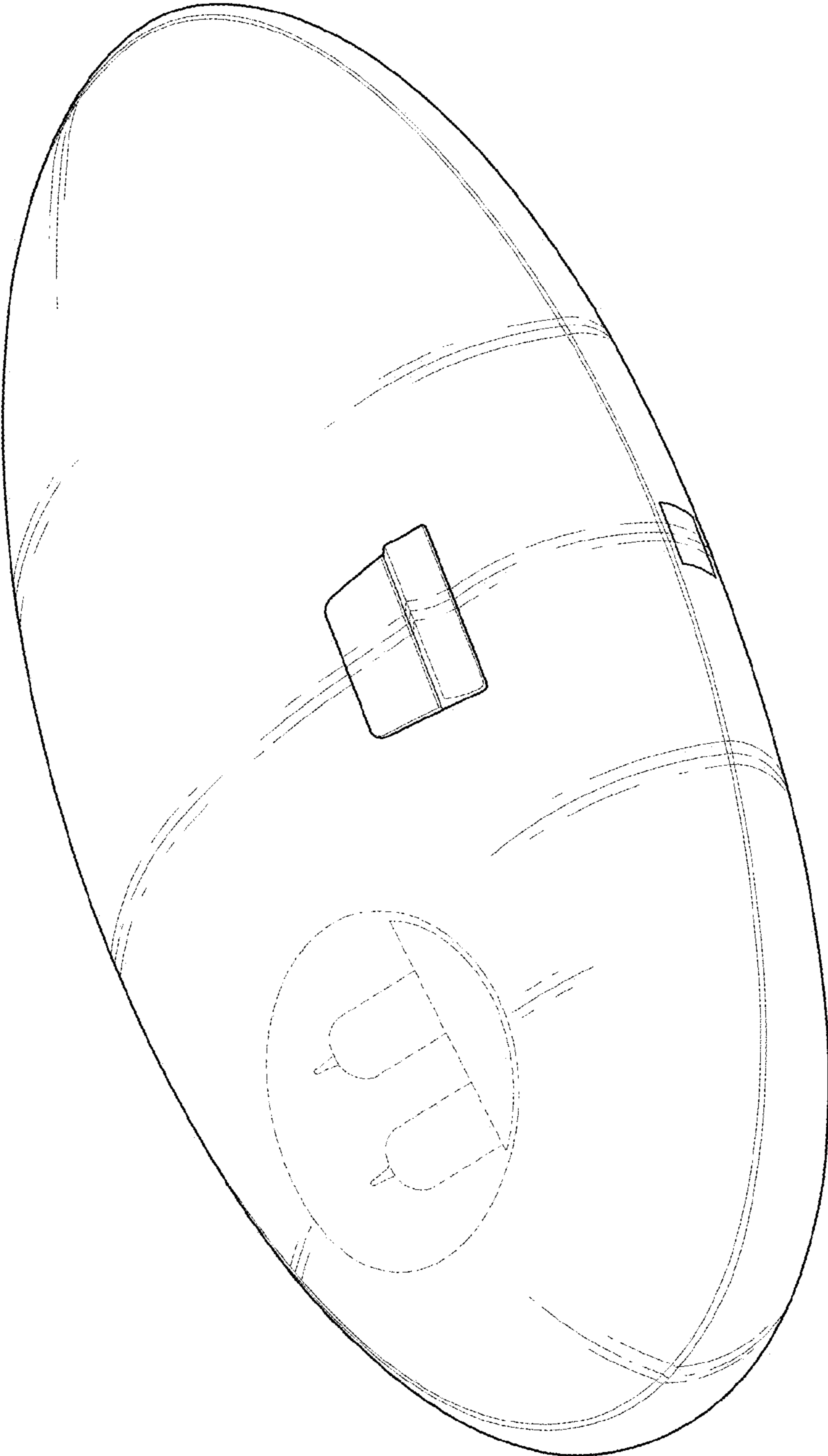

FIG. 2

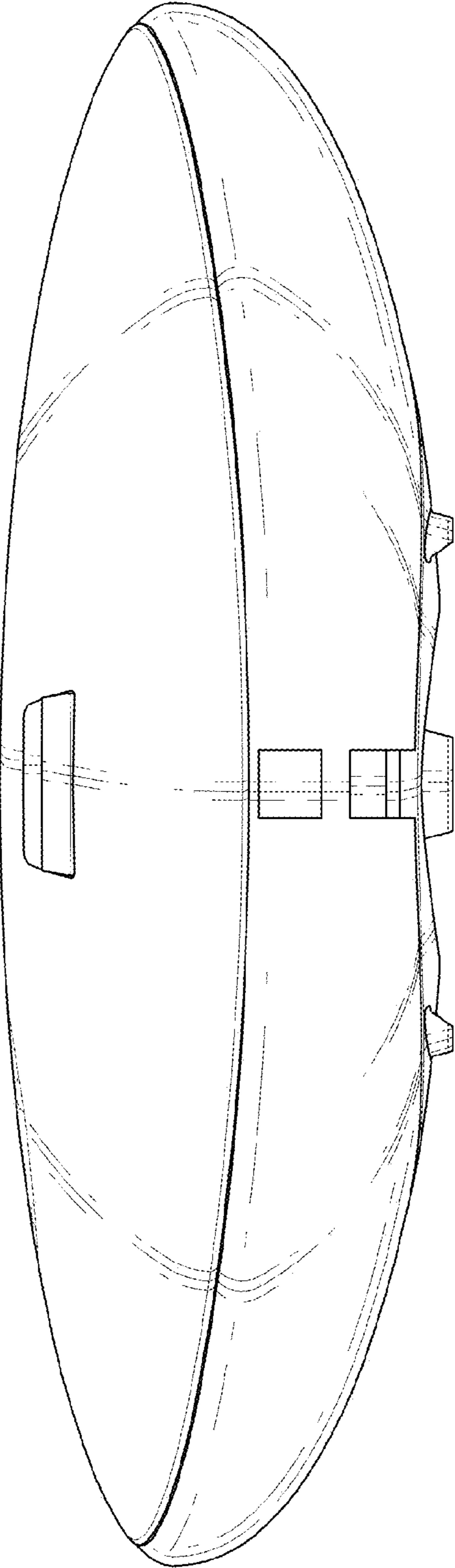

FIG. 3

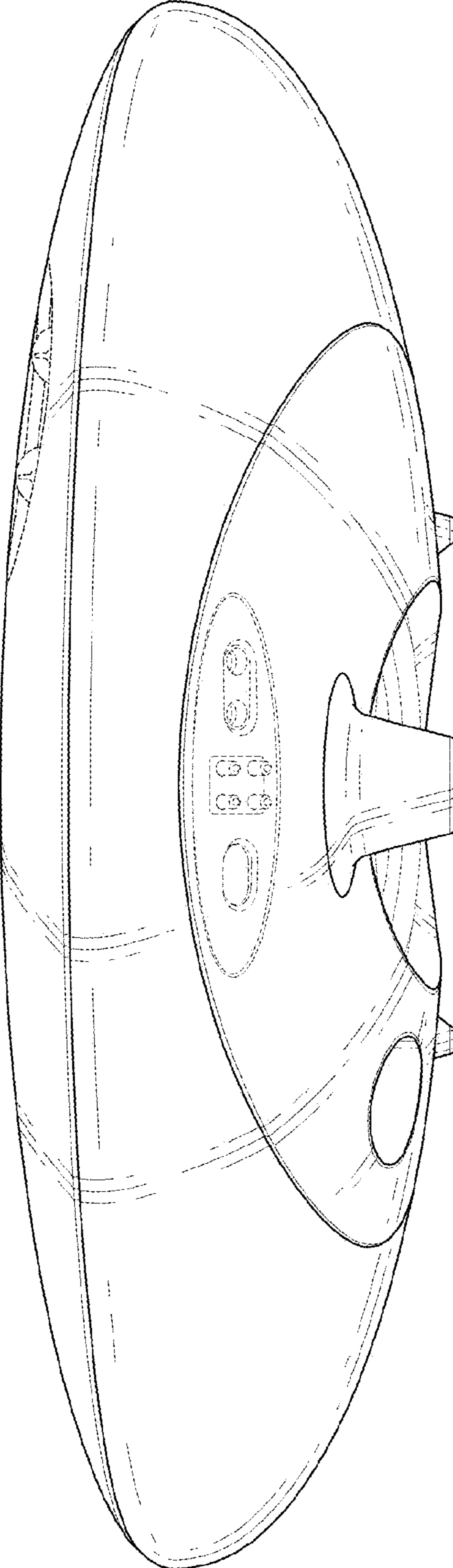

FIG. 4

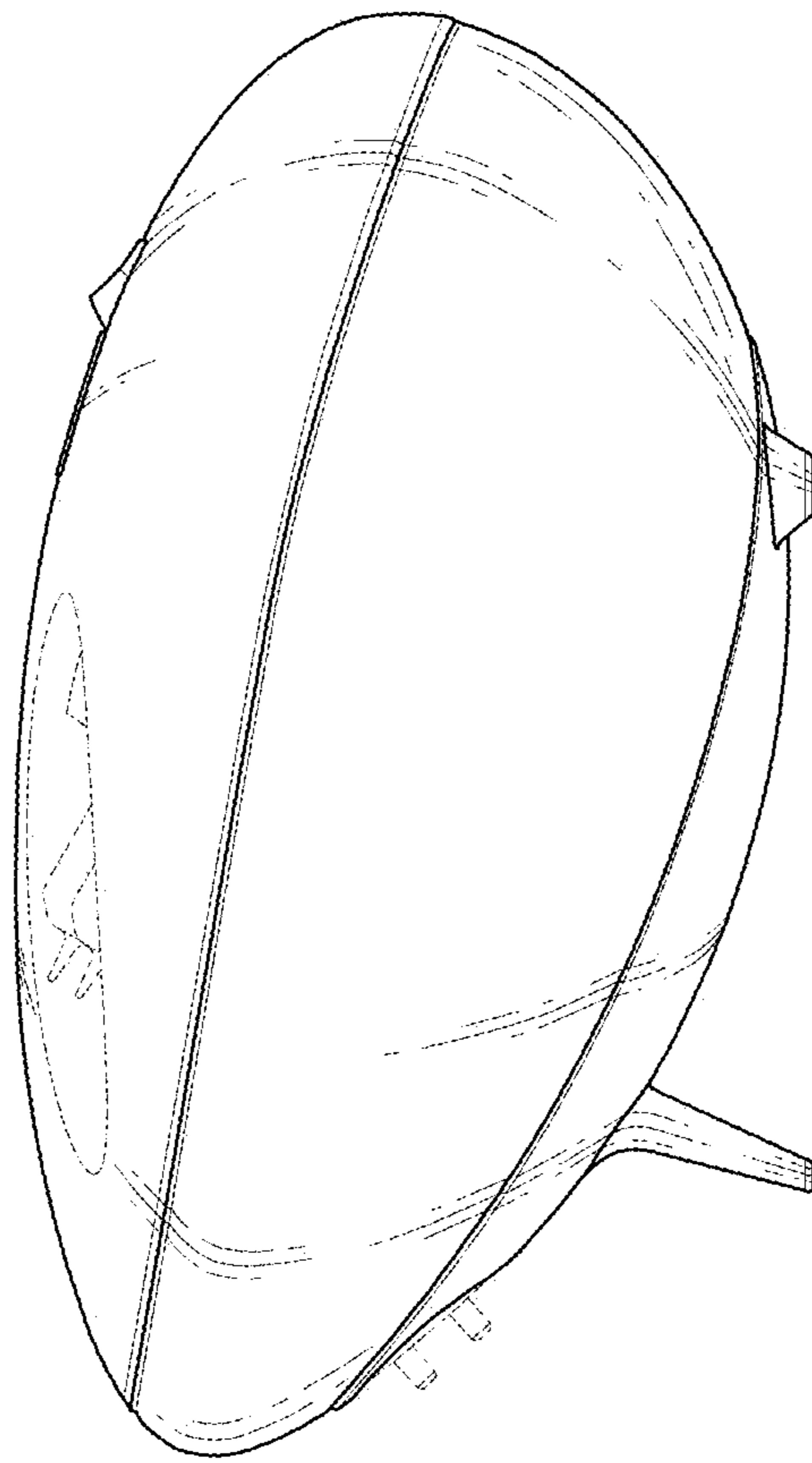

FIG. 5



FIG. 6

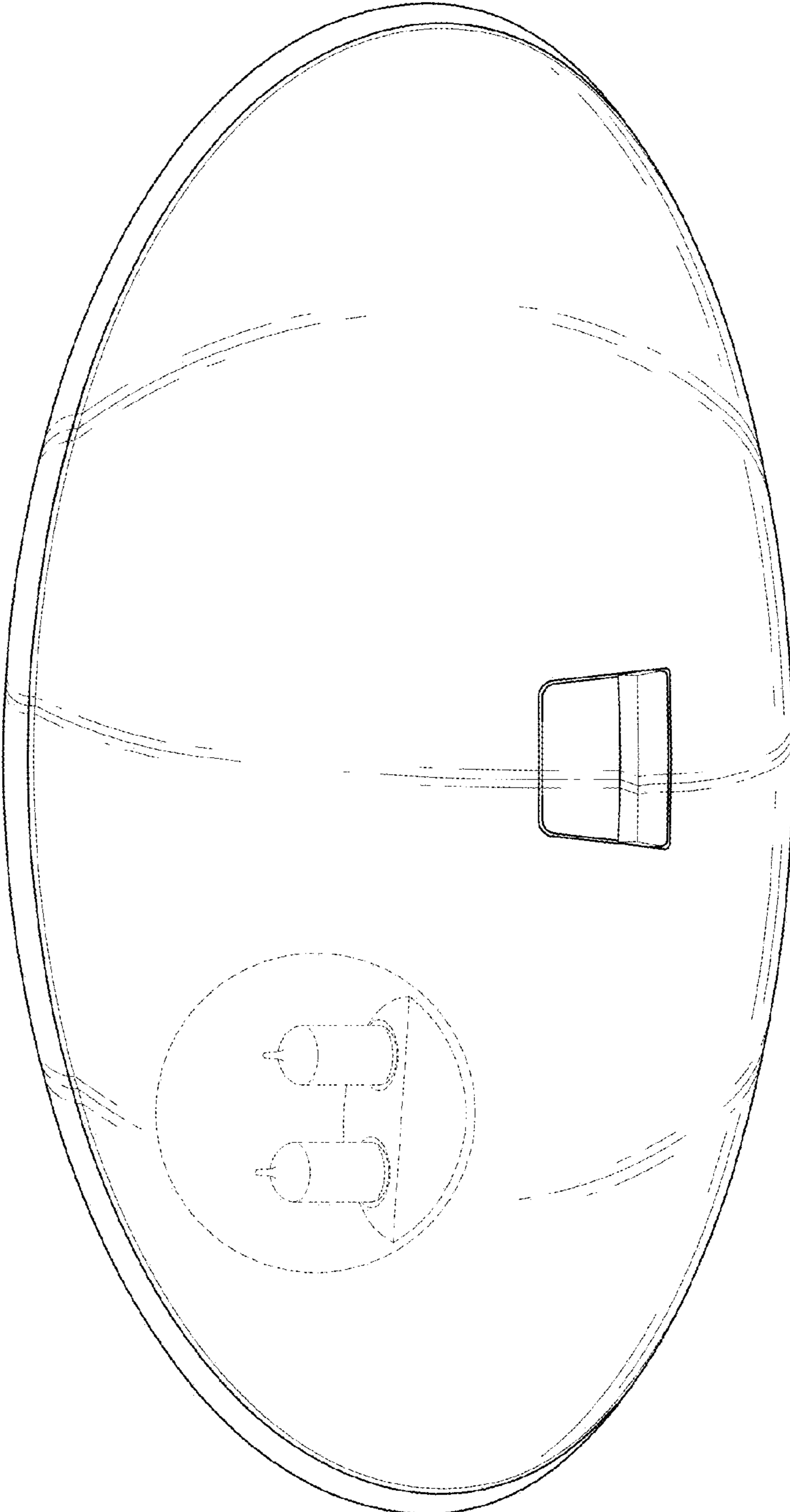

FIG. 7

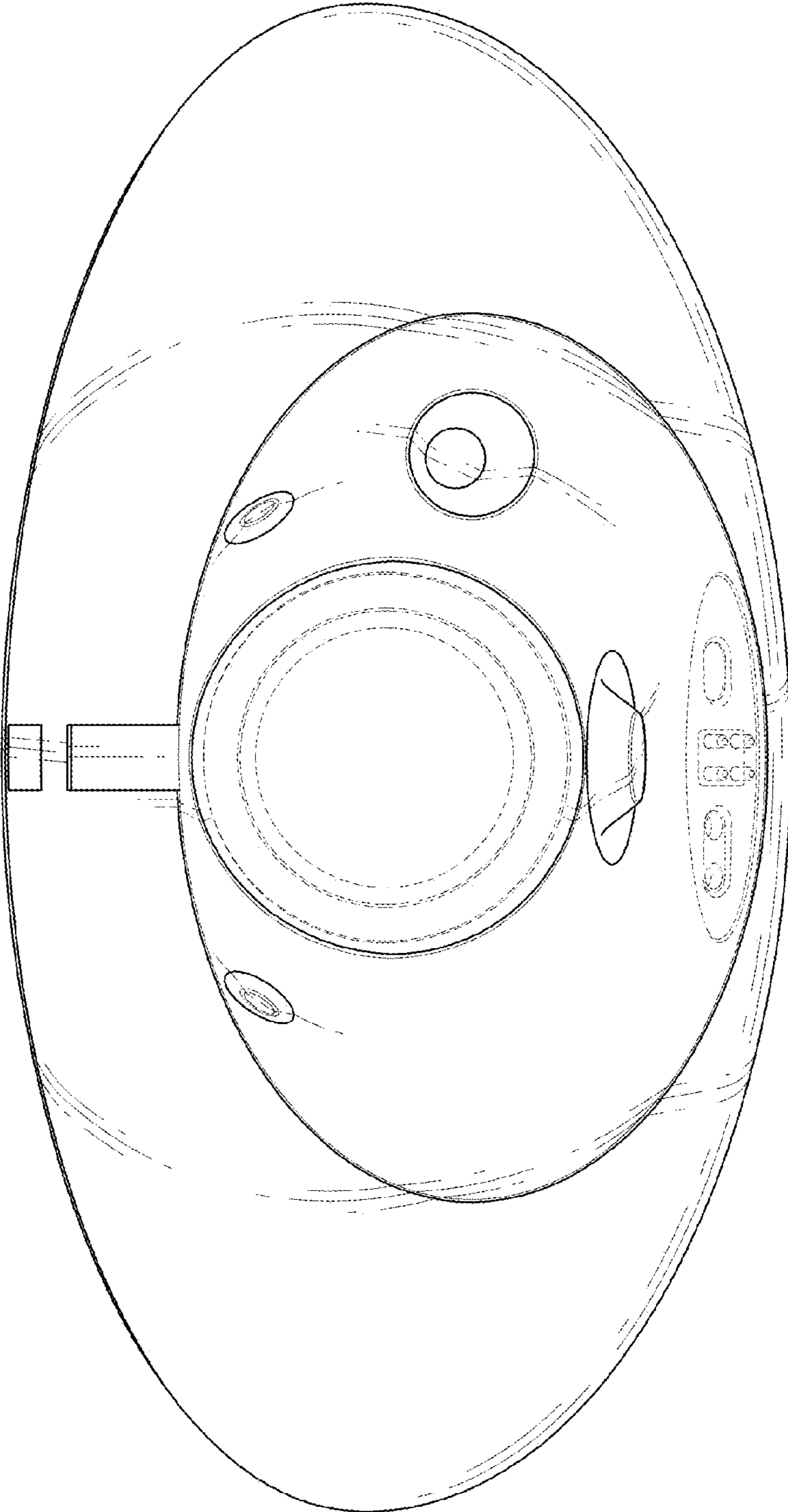

FIG. 8

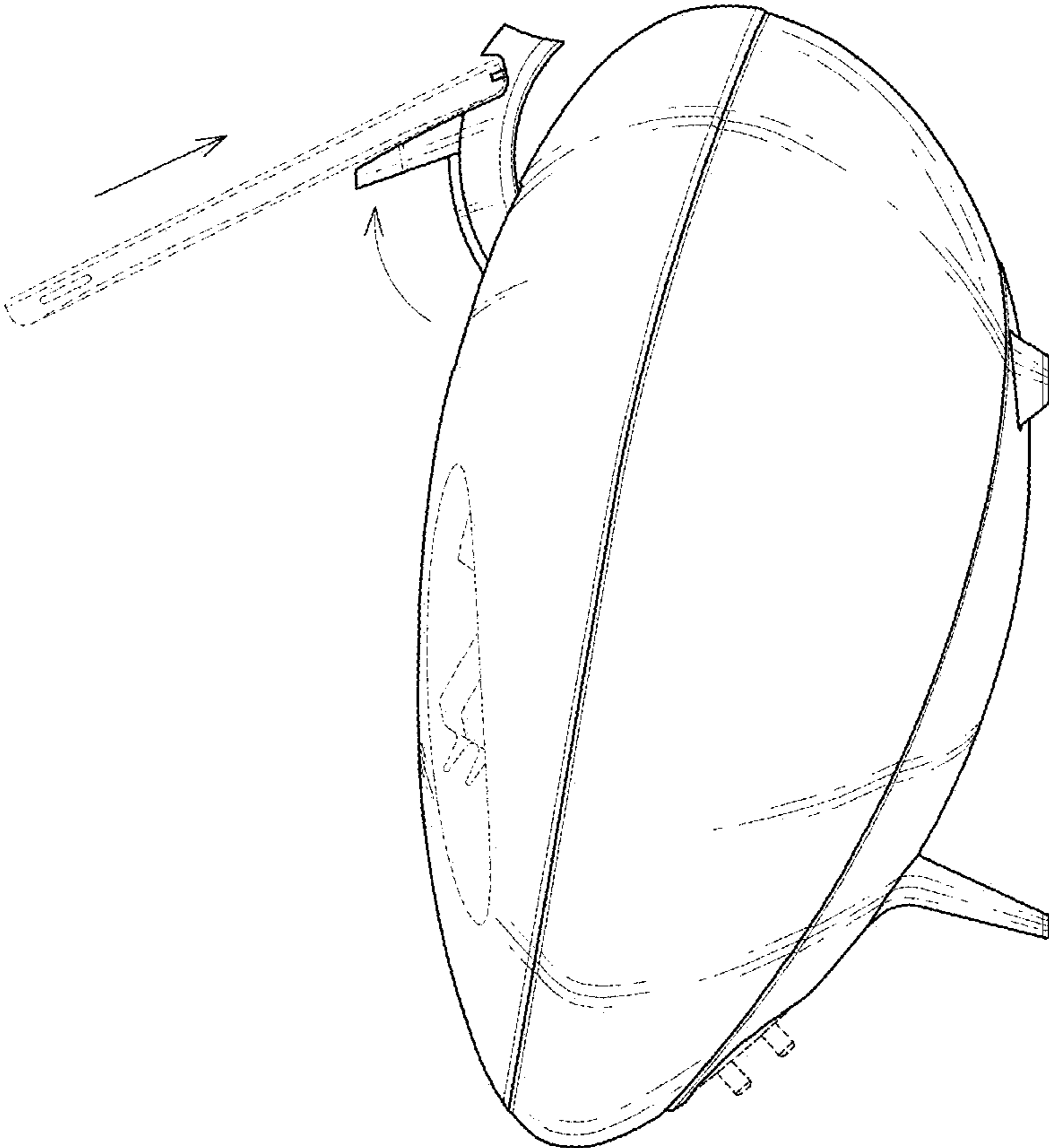

FIG. 9

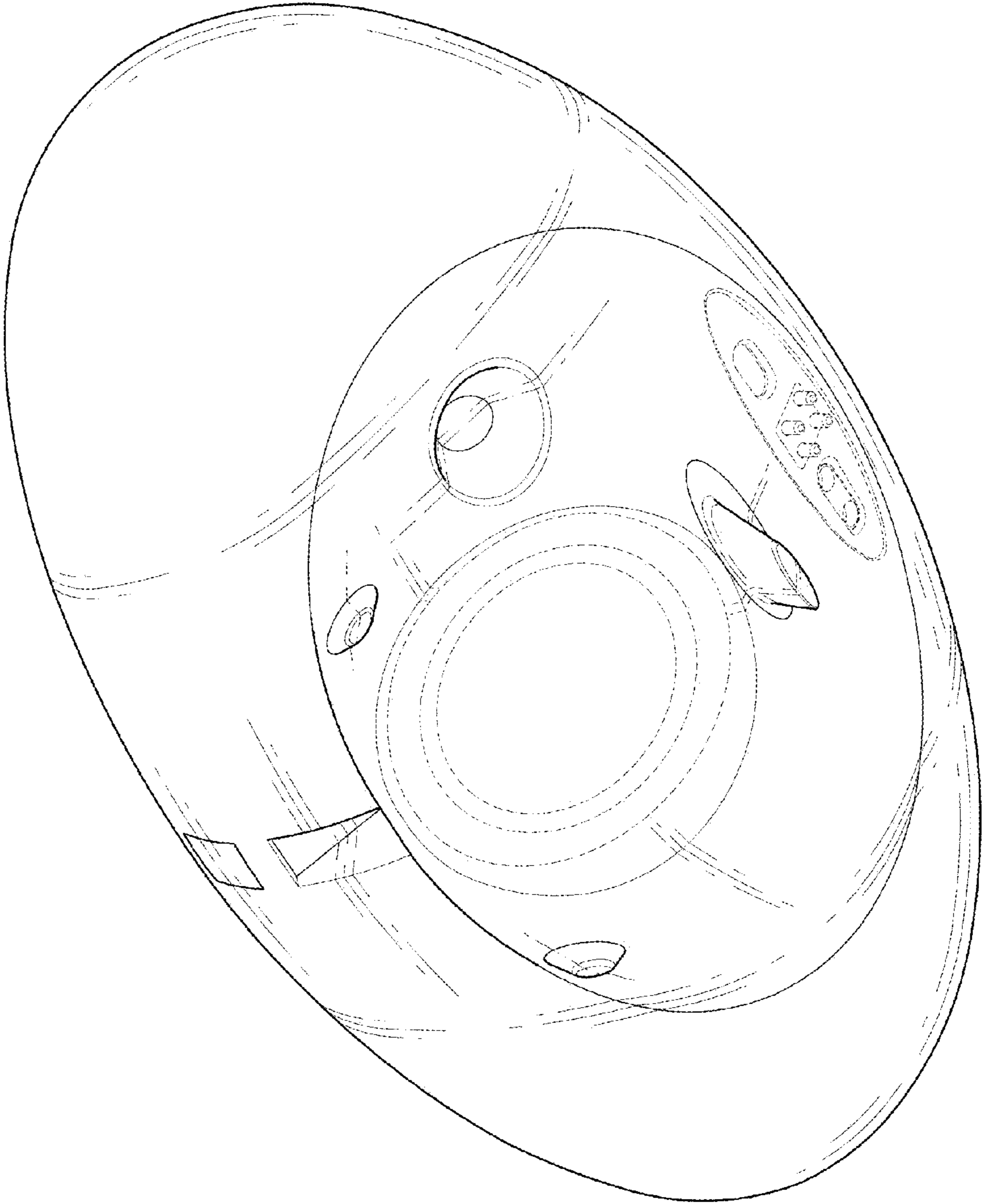

FIG. 10

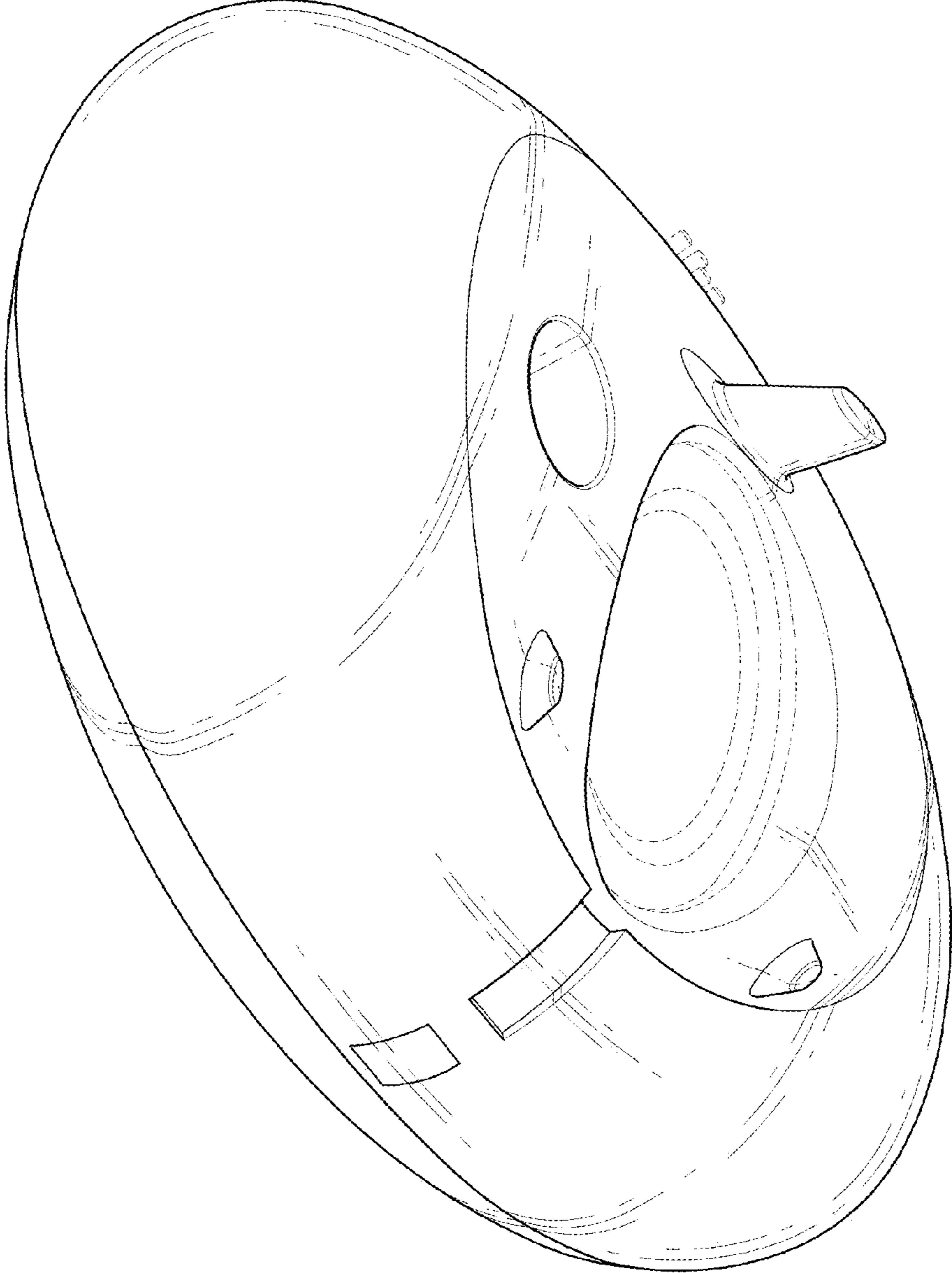

FIG. 11

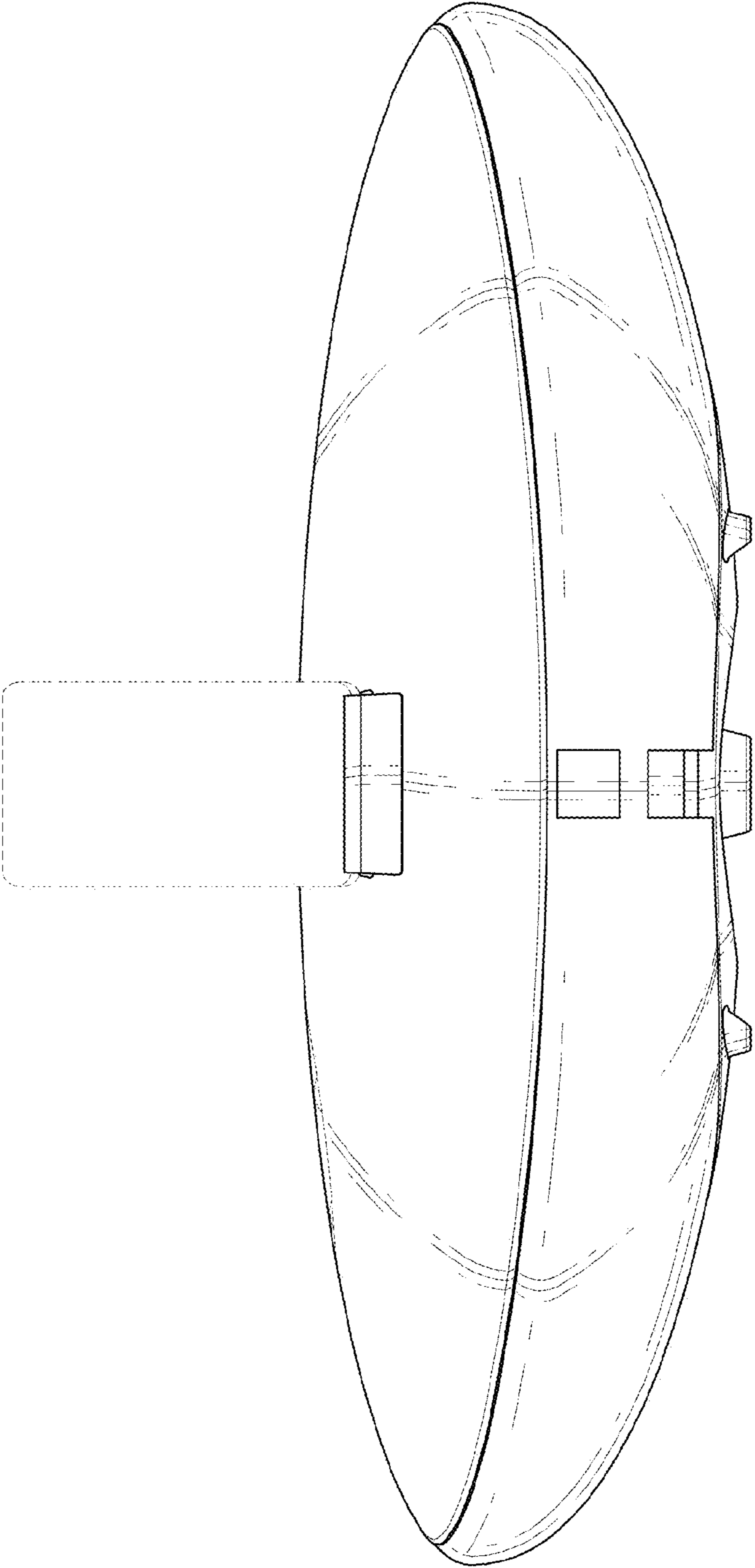

FIG. 12

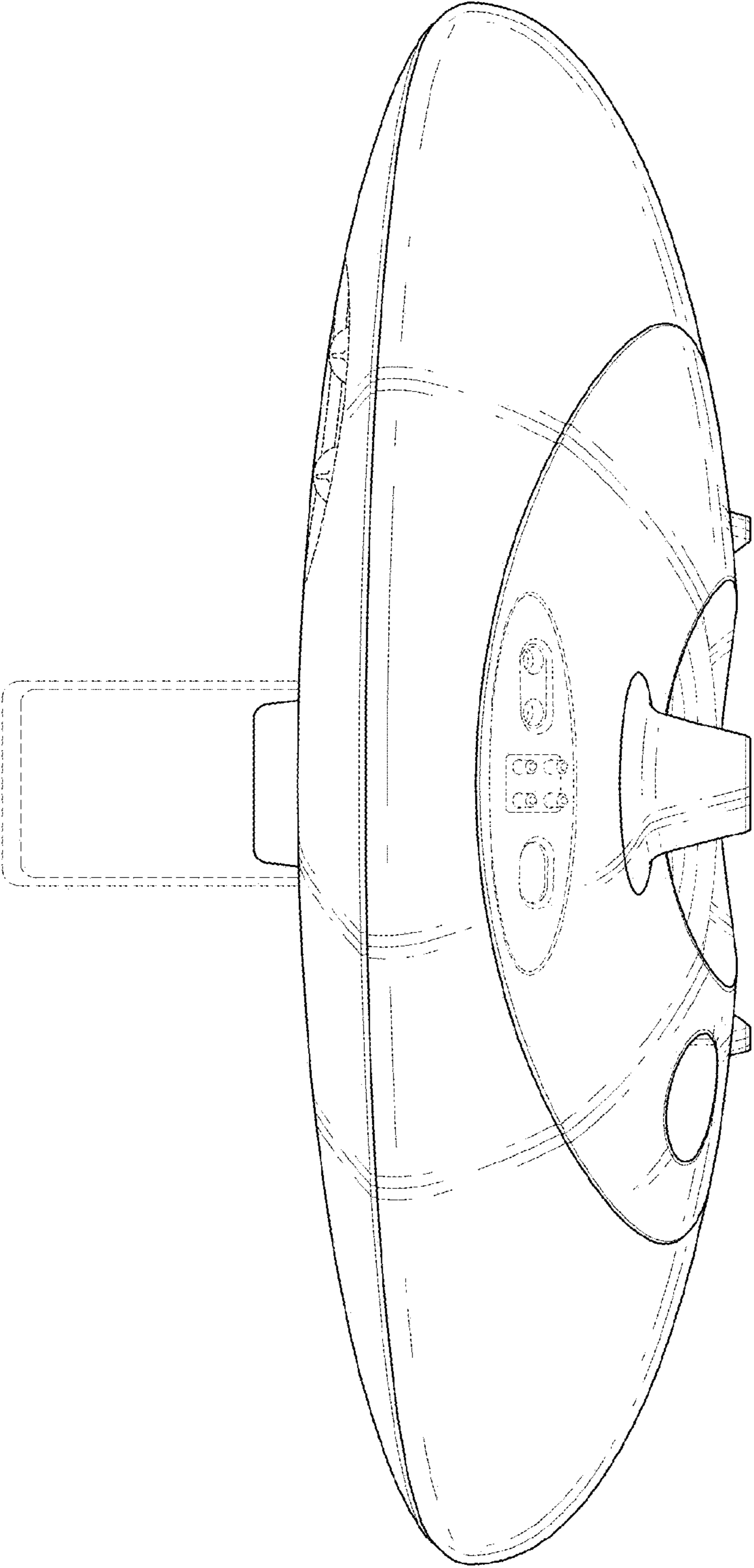

FIG. 13

