



US00D709023S

(12) **United States Design Patent**
Viviani et al.

(10) **Patent No.:** **US D709,023 S**
(45) **Date of Patent:** **** Jul. 15, 2014**

- (54) **HULL FOR A BOAT**
- (71) Applicants: **Albert Viviani**, Monaco (MC); **Arye Laniado**, Monaco (MC); **Joshua Laniado**, Monaco (MC); **Yann Le Jeune**, Villefrance sur Mer (FR); **Pietro Lagioia**, Bari (IT)
- (72) Inventors: **Albert Viviani**, Monaco (MC); **Arye Laniado**, Monaco (MC); **Joshua Laniado**, Monaco (MC); **Yann Le Jeune**, Villefrance sur Mer (FR); **Pietro Lagioia**, Bari (IT)

- 3,200,782 A 8/1965 Walden at al.
- 3,330,239 A 7/1967 Dornak
- 3,342,154 A 9/1967 Le Marec
- 3,503,358 A 3/1970 Moesly

(Continued)

FOREIGN PATENT DOCUMENTS

- EP 0466382 1/1992
- EP 1075415 11/1999
- JP 01-095991 4/1989
- WO WO 9836961 8/1998

OTHER PUBLICATIONS

European Search Report mailed in European Patent Application No. 12196282.3 on Mar. 27, 2013 (8 pages).

Primary Examiner — Cynthia M Chin

(74) *Attorney, Agent, or Firm* — Finnegan, Henderson, Farabow, Garrett & Dunner LLP

(73) Assignee: **3MadMen** (MC)

(**) Term: **14 Years**

(21) Appl. No.: **29/473,705**

(22) Filed: **Nov. 25, 2013**

(51) **LOC (10) Cl.** **12-06**

(52) **U.S. Cl.**
USPC **D12/300**

(58) **Field of Classification Search**
USPC D12/300, 302, 303, 304, 307, 310–314,
D12/316, 317; 114/39.11–39.15,
114/39.21–39.32, 61.1, 61.2, 61.32, 61.33,
114/62, 355–358, 271, 273, 288–291
See application file for complete search history.

(57) **CLAIM**

The ornamental design for a hull for a boat, as shown and described.

DESCRIPTION

FIG. 1 is a top left front perspective view of a boat hull showing my new design;
FIG. 2 is a bottom right front perspective view thereof;
FIG. 3 is a bottom right rear perspective view thereof;
FIG. 4 is a left elevation view thereof;
FIG. 5 is a bottom plan view thereof;
FIG. 6 is a top plan view thereof;
FIG. 7 is a front elevation view thereof;
FIG. 8 is a rear elevation view thereof;
FIG. 9 is bottom left front perspective view thereof;
FIG. 10 is a bottom front perspective view;
FIG. 11 is a bottom rear perspective view;
FIG. 12 is a bottom left rear perspective view; and,
FIG. 13 is a top rear perspective view.
The broken lines of uneven length in FIGS. 1, 6, 8, and 13 define the outer boundary of the claimed design.

(56) **References Cited**

U.S. PATENT DOCUMENTS

- 652,876 A 7/1900 Andrade
- 1,204,355 A 11/1916 Hickman
- 1,316,762 A 9/1919 Bigelow
- 1,620,349 A 3/1927 Hickman
- 1,644,725 A 10/1927 Hickman
- 1,670,623 A 5/1928 Hickman
- 1,681,342 A 8/1928 Hickman
- 2,285,959 A 6/1942 Dubay
- 2,423,796 A 7/1947 Platt
- 2,515,005 A 7/1950 Hickman
- D197,099 S 12/1963 Torreson
- 3,191,572 A 6/1965 Henry

1 Claim, 11 Drawing Sheets

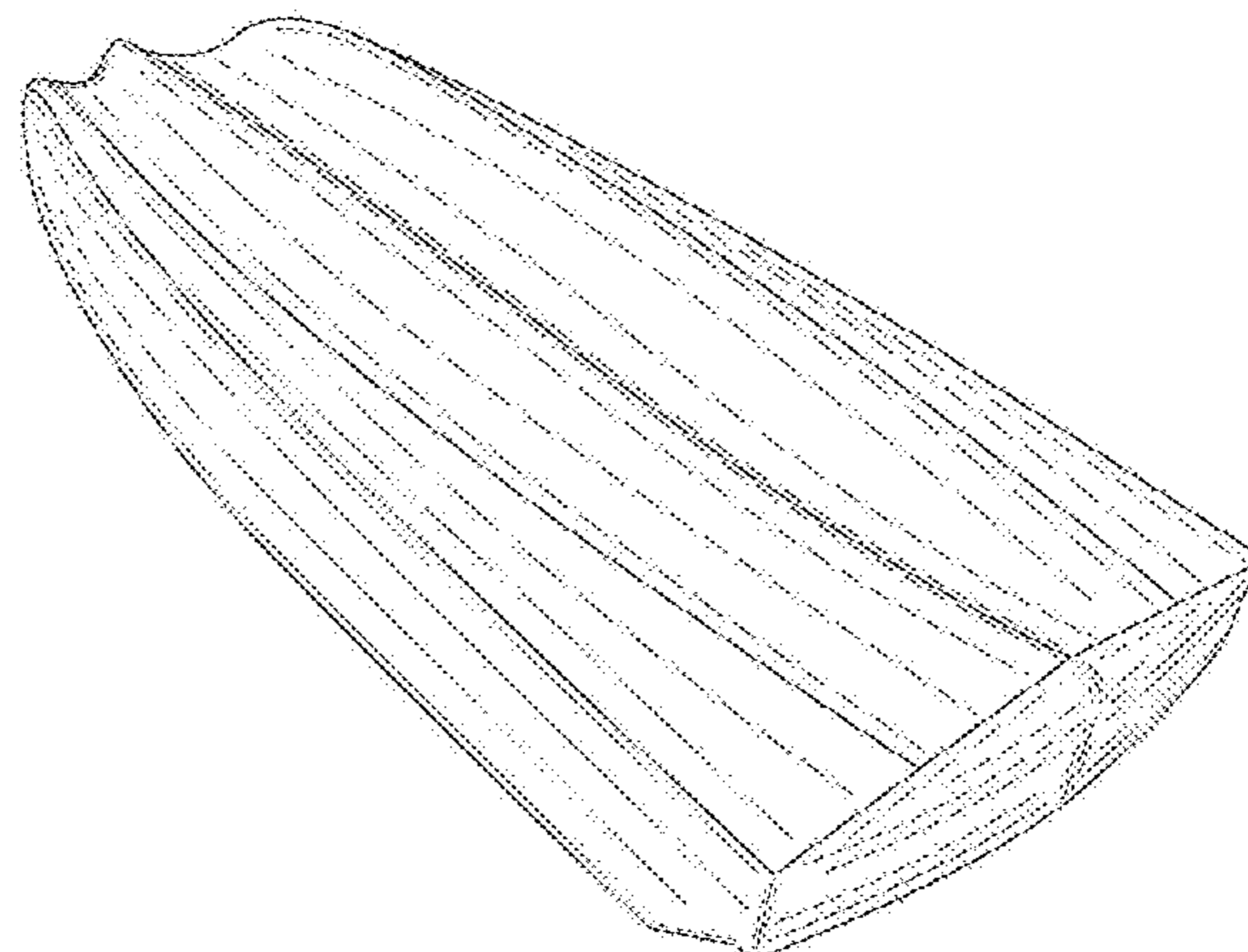

(56)

References Cited

U.S. PATENT DOCUMENTS

D219,555 S	12/1970	Field	6,192,819 B1	2/2001	Larson et al.	
D219,795 S	1/1971	Field	6,250,245 B1	6/2001	Robinson et al.	
3,675,605 A	7/1972	Knerr	6,293,216 B1	9/2001	Barsumian	
3,709,179 A	1/1973	Payne	6,314,903 B2	11/2001	Robinson et al.	
3,797,437 A	3/1974	Cowles	6,374,762 B1	4/2002	Larson et al.	
3,800,725 A	4/1974	L'Heureux	6,526,906 B1	3/2003	Bidanset et al.	
3,902,445 A	9/1975	Stolk	6,604,478 B2	8/2003	Barsumian	
4,192,248 A	3/1980	Moyer	6,708,642 B1 *	3/2004	Taylor	114/290
4,478,166 A	10/1984	Sorensen	6,868,798 B2	3/2005	Robinson et al.	
D301,573 S	6/1989	Fuller	6,941,884 B2	9/2005	Moore	
D302,969 S *	8/1989	Pipkorn	6,983,713 B1	1/2006	Robinson et al.	
D306,631 S	3/1990	Aguilar	7,063,031 B2	6/2006	Earl, Jr. et al.	
4,922,844 A *	5/1990	Solia	7,093,553 B2	8/2006	Robinson et al.	
D318,041 S *	7/1991	Meredith	7,252,047 B1	8/2007	Baucom, Jr.	
5,140,930 A	8/1992	Lund	7,305,926 B2 *	12/2007	Seider	114/61.1
5,231,949 A	8/1993	Hadley	7,316,193 B1 *	1/2008	Greenbaum	114/125
5,265,554 A *	11/1993	Meredith	D570,278 S	6/2008	Horais	
5,351,641 A	10/1994	Robson	7,418,915 B2	9/2008	Campbell	
D355,881 S *	2/1995	Carlson	D581,340 S *	11/2008	Fafard et al.	D12/300
5,419,274 A	5/1995	Van Diepen	7,458,332 B2	12/2008	Wilson et al.	
5,427,048 A	6/1995	Takeuchi	D595,204 S	6/2009	Robinson	
5,458,078 A	10/1995	Perette	7,578,250 B2	8/2009	Baker	
5,474,014 A	12/1995	Russell	7,625,153 B2	12/2009	Sauerbier	
5,526,762 A	6/1996	Kiley	7,677,190 B2	3/2010	Miller	
5,549,071 A	8/1996	Pigeon et al.	7,677,192 B2 *	3/2010	Scism et al.	114/288
D382,850 S	8/1997	Schmidt	7,699,016 B2	4/2010	Larson et al.	
5,655,473 A	8/1997	Arvilla	D643,357 S	8/2011	Moore et al.	
5,664,910 A	9/1997	Lochtefeld et al.	8,011,313 B2 *	9/2011	Sasayama	114/271
5,718,184 A	2/1998	Holland	D651,551 S	1/2012	Moore et al.	
D400,156 S	10/1998	Duvenage	8,109,221 B2 *	2/2012	Graf et al.	114/61.2
5,860,384 A	1/1999	Castillo	8,281,730 B2 *	10/2012	Munson	114/288
5,860,766 A	1/1999	Lochtefeld et al.	2003/0041791 A1	3/2003	Chollet et al.	
D405,411 S	2/1999	Schmidt	2004/0129192 A1	7/2004	Guerard	
D418,104 S	12/1999	Bove	2009/0308300 A1	12/2009	Baker	
6,044,708 A	4/2000	Hirosawa	2010/0275829 A1	11/2010	Sporsheim	
6,047,657 A	4/2000	Cox	2011/0017115 A1	1/2011	Olofsson	
6,105,527 A	8/2000	Lochtefeld et al.	2013/0145978 A1	6/2013	Viviani et al.	
			2013/0220193 A1	8/2013	Viviani at al,	

* cited by examiner

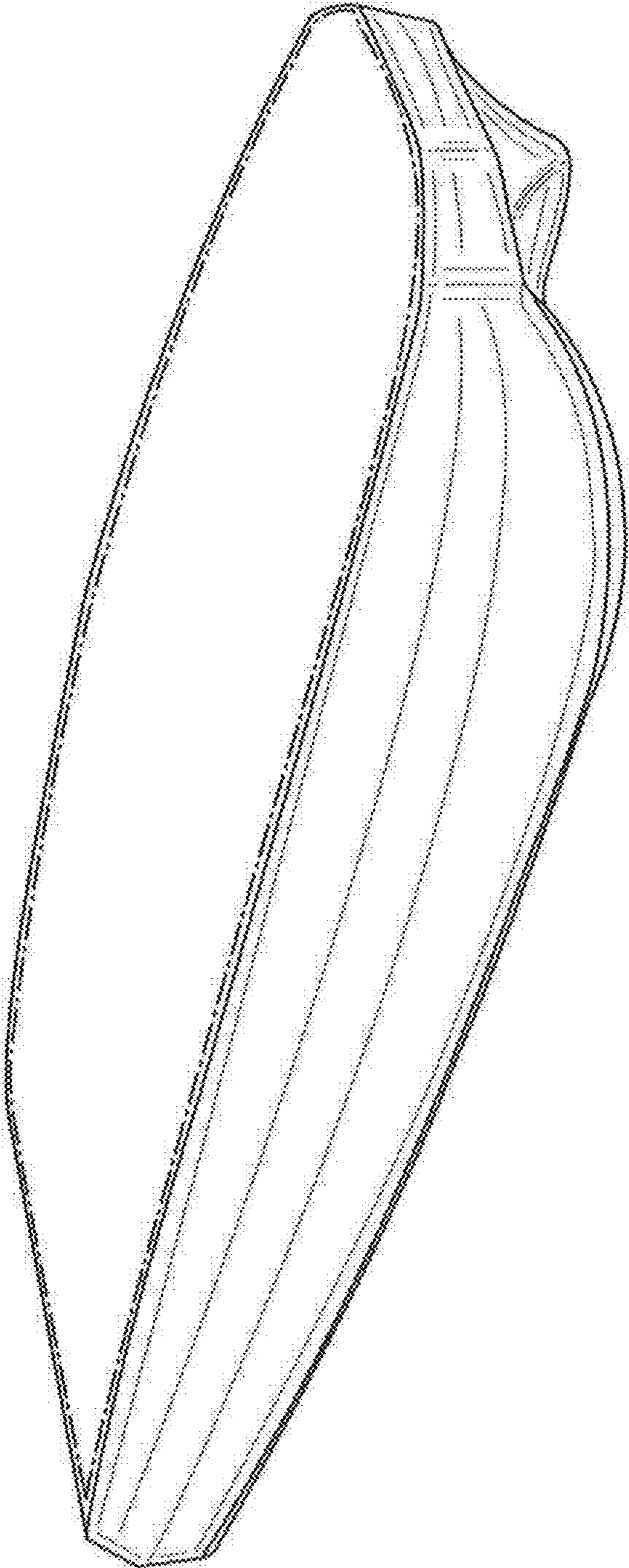

FIG. 1

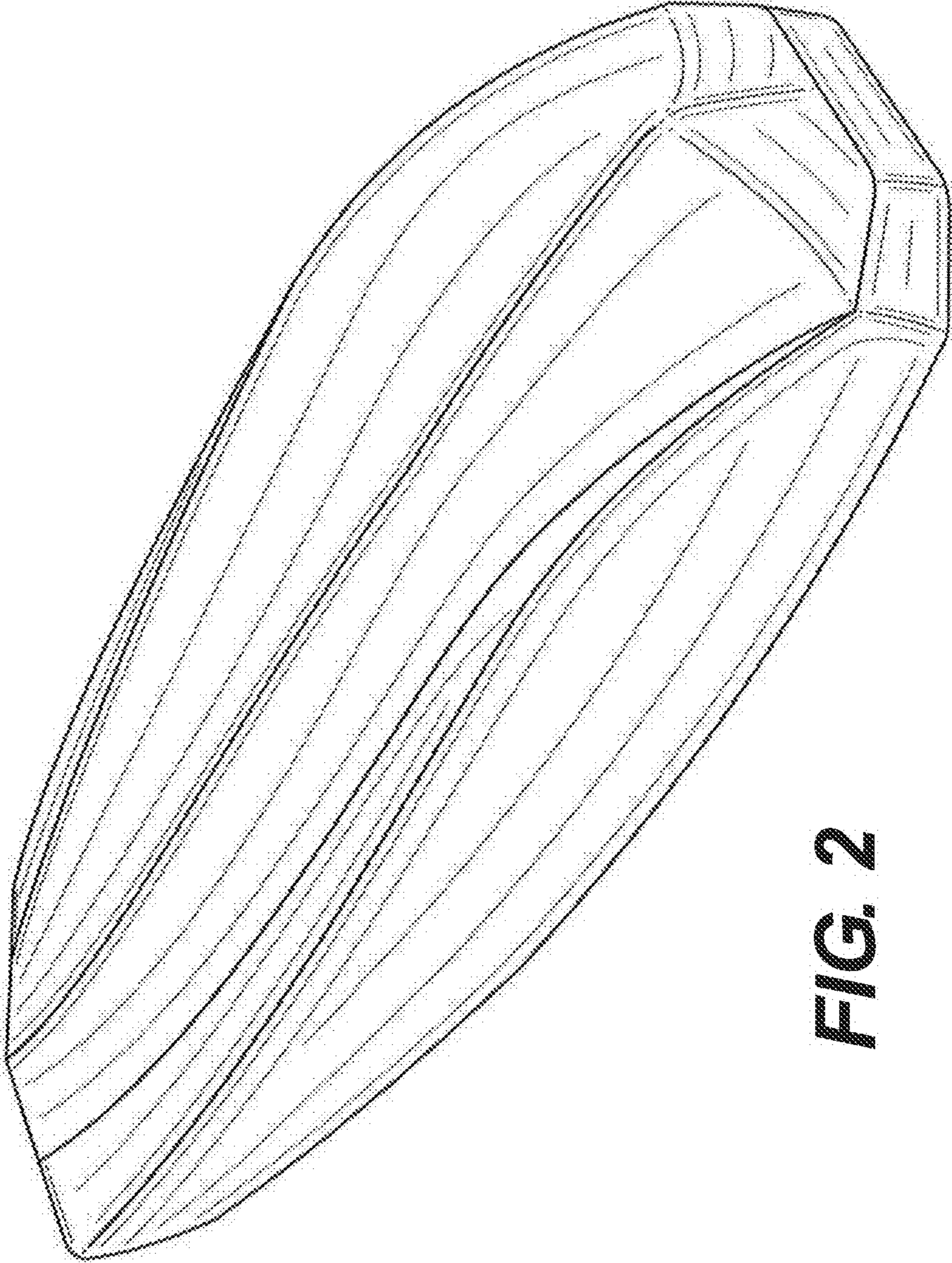

FIG. 2

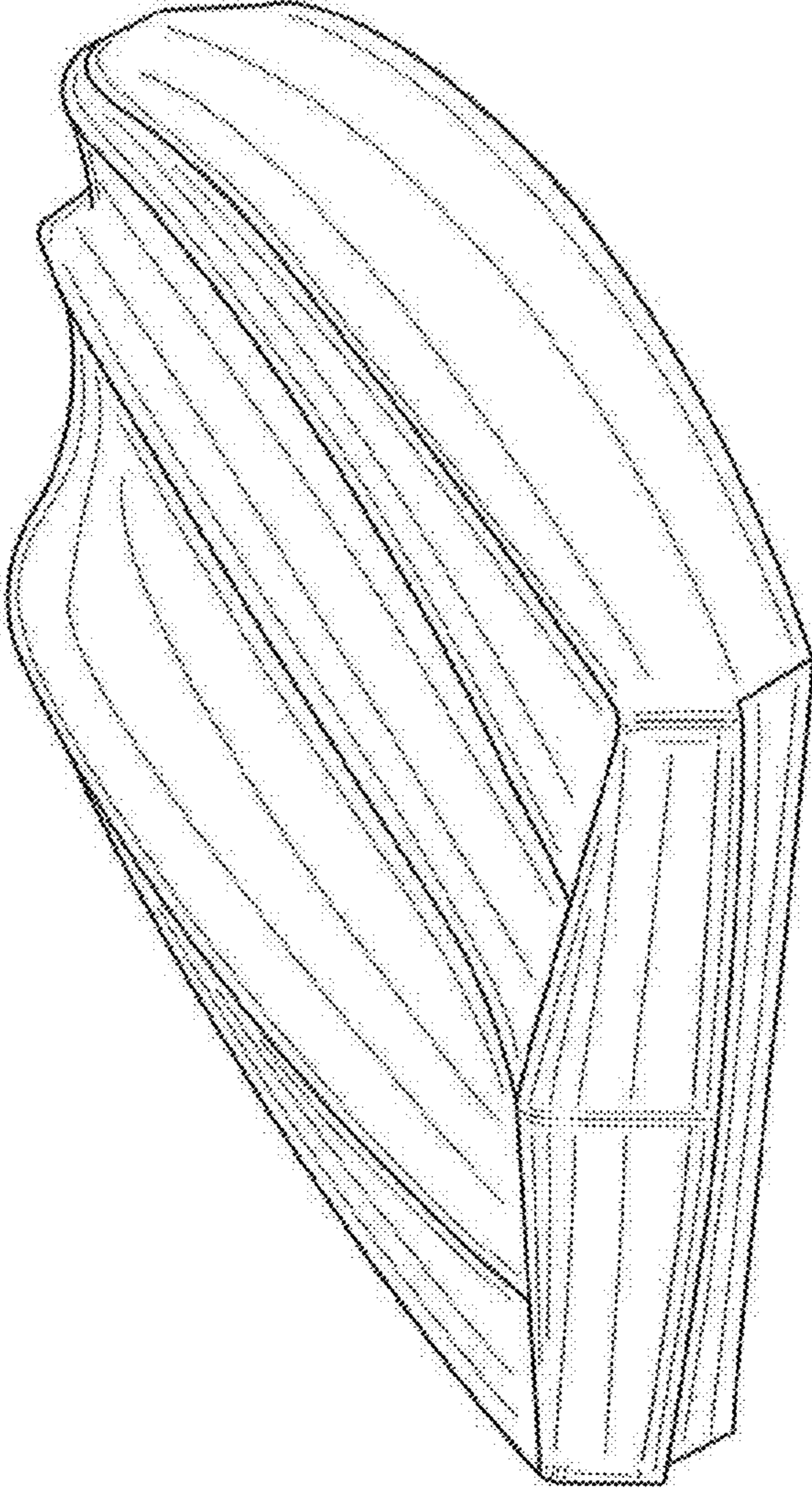

FIG. 3

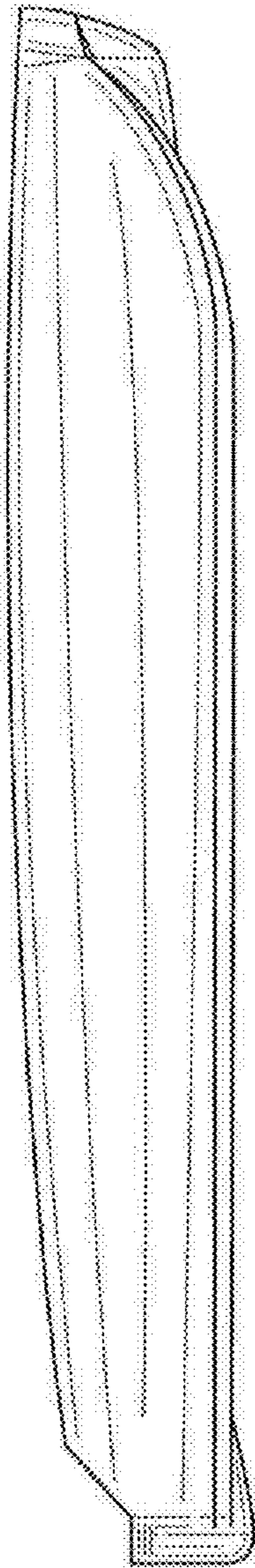

FIG. 4

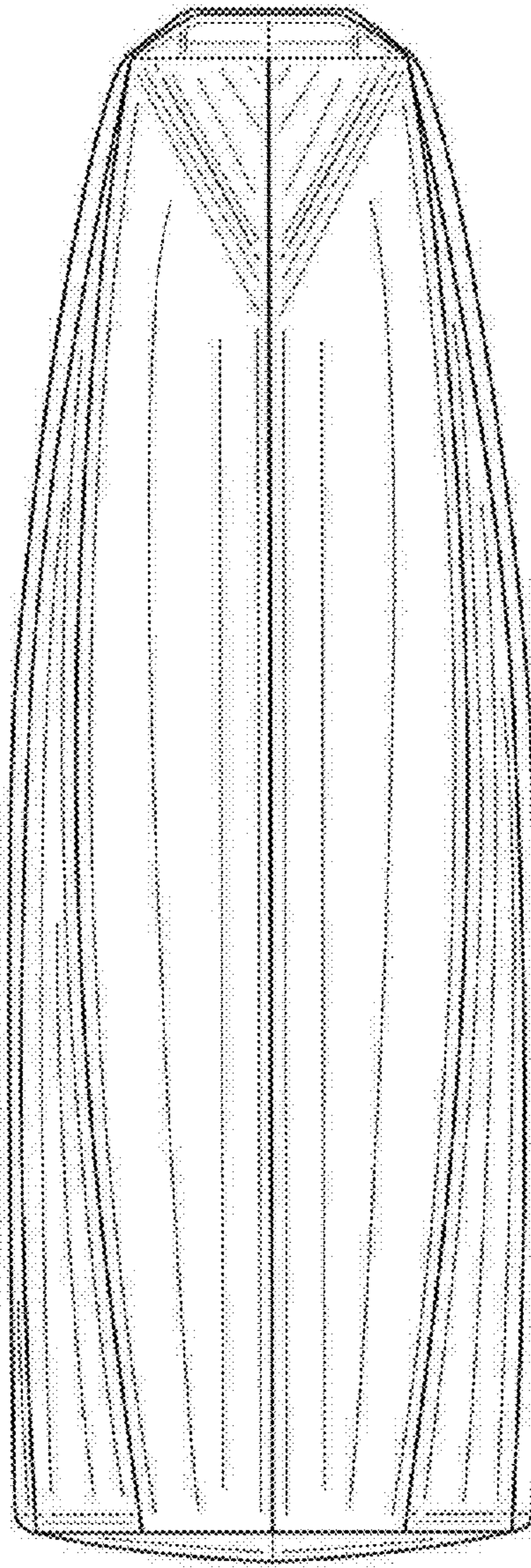

FIG. 5

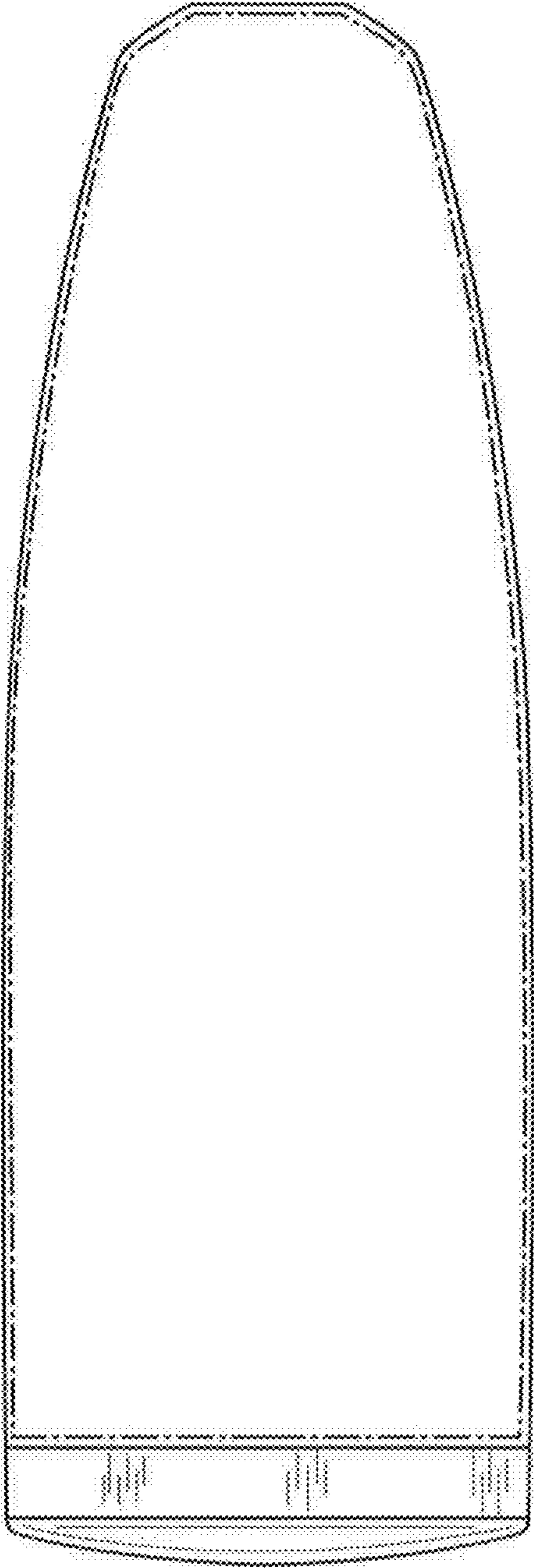

FIG. 6

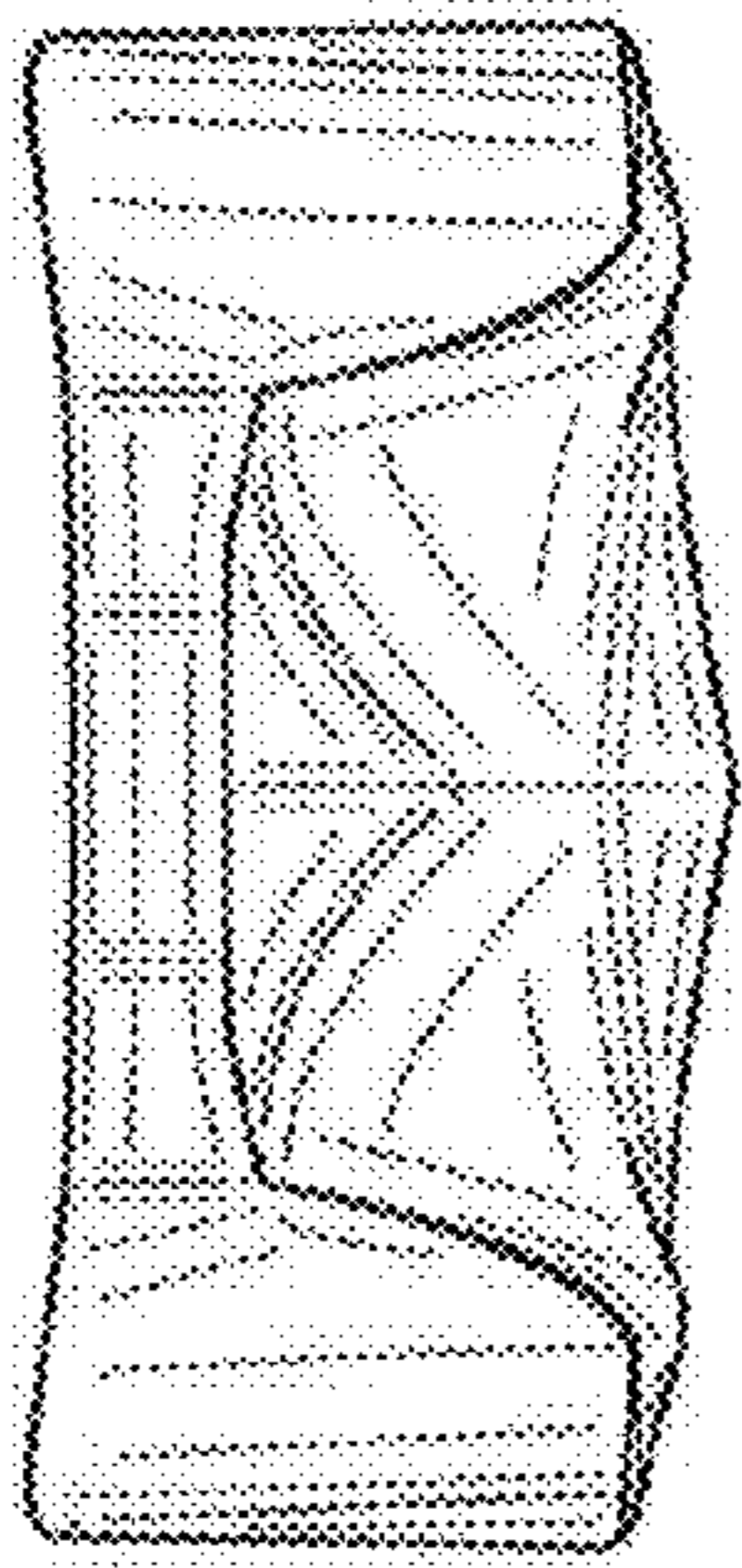

FIG. 7

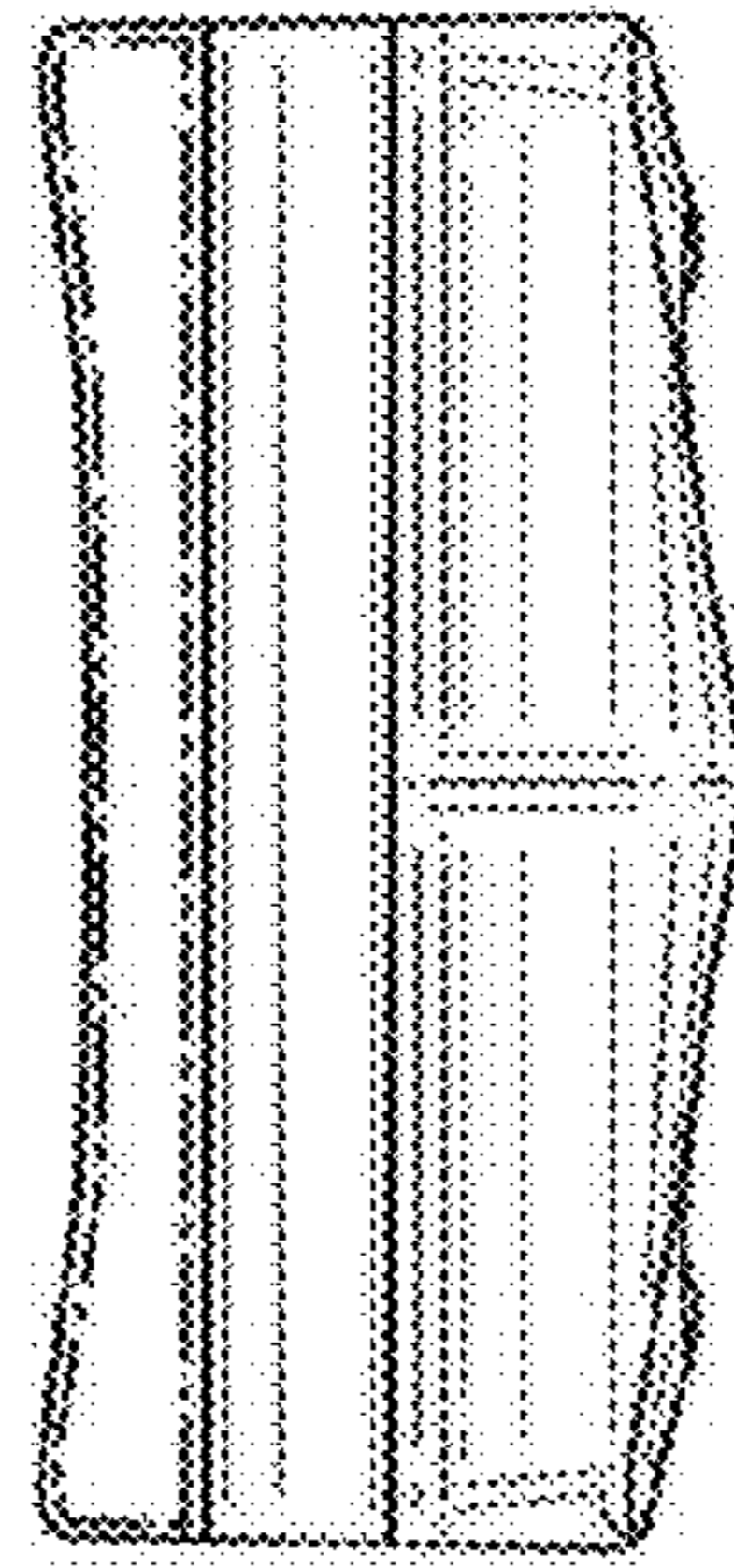

FIG. 8

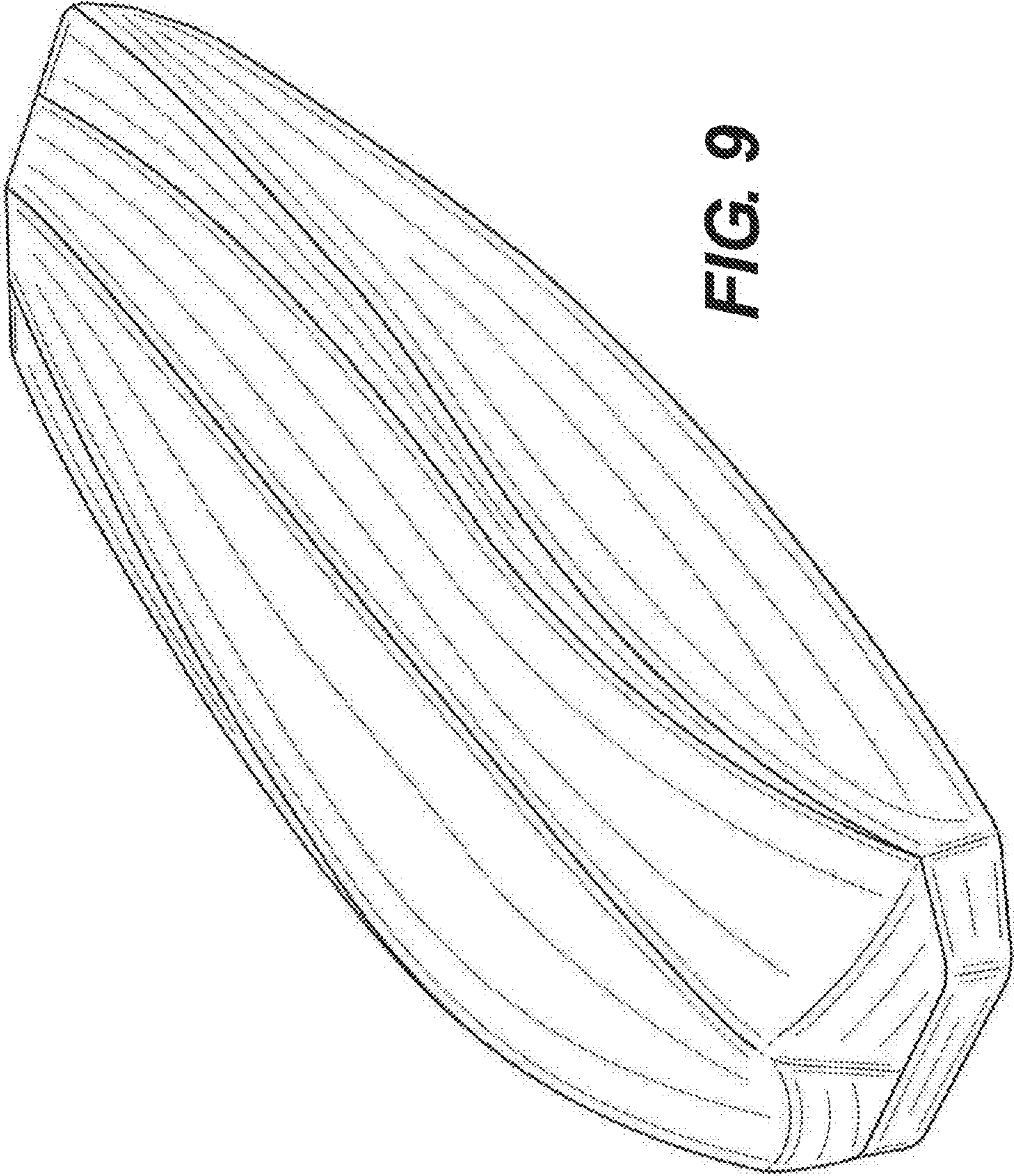

FIG. 9

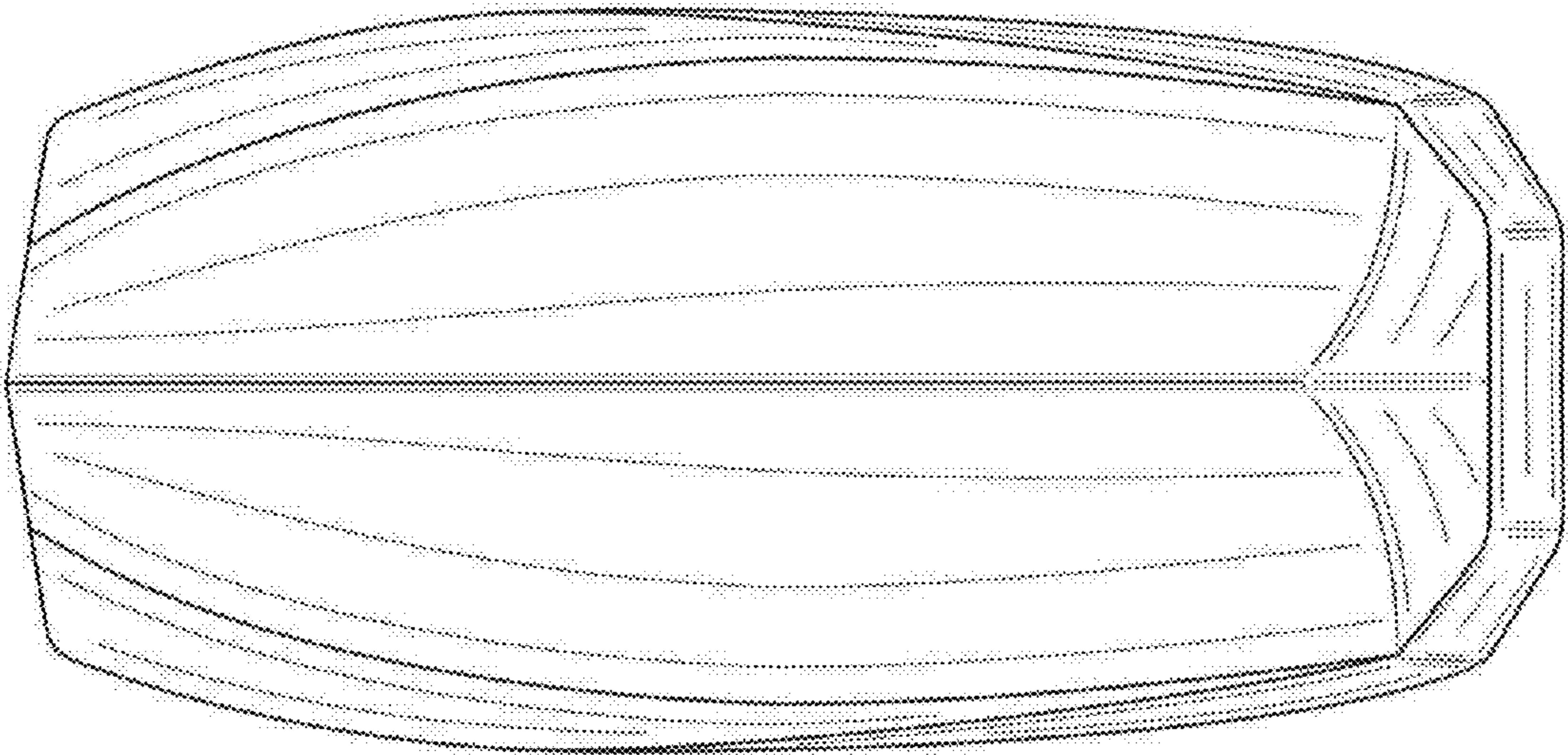

FIG. 10

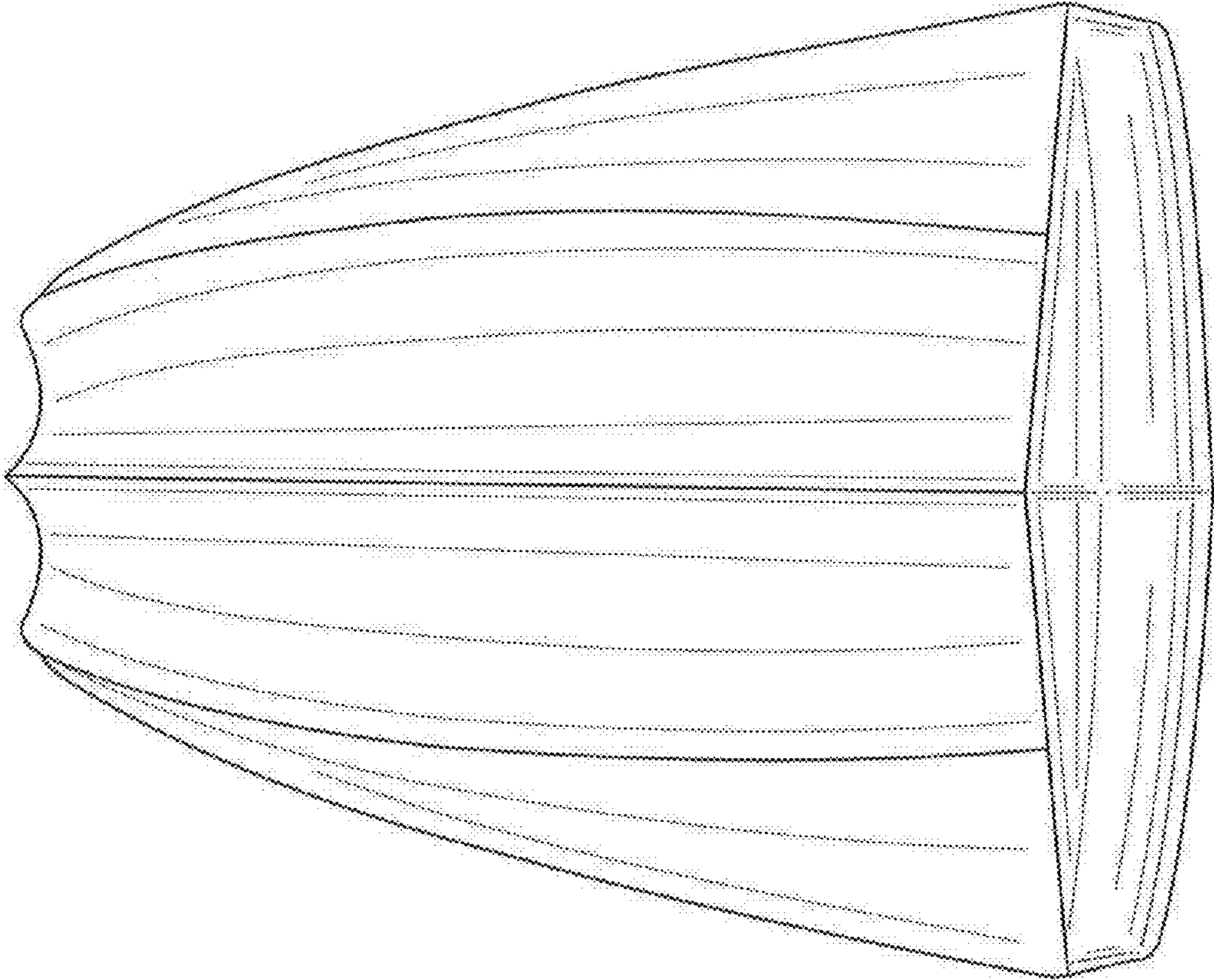

FIG. 11

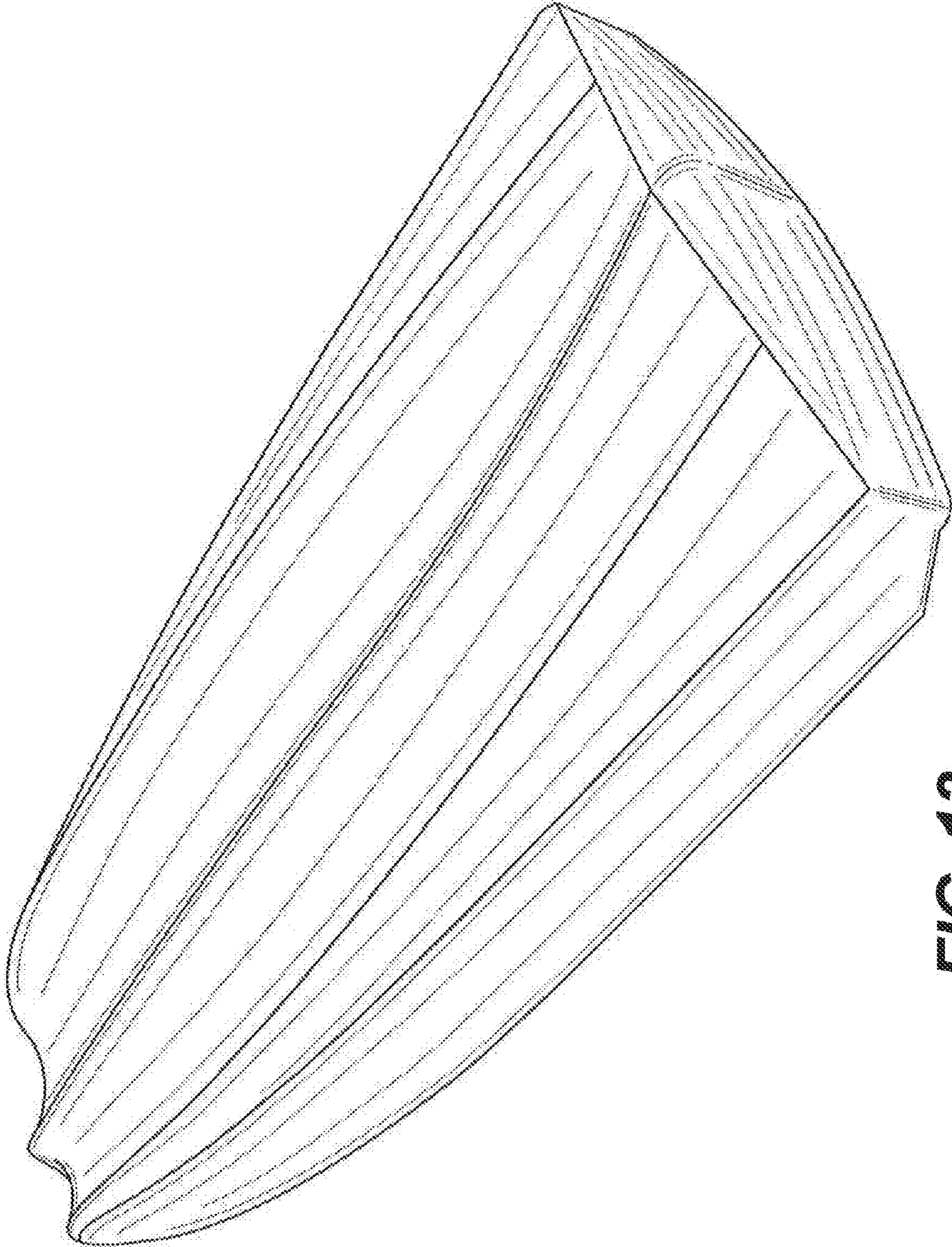

FIG. 12

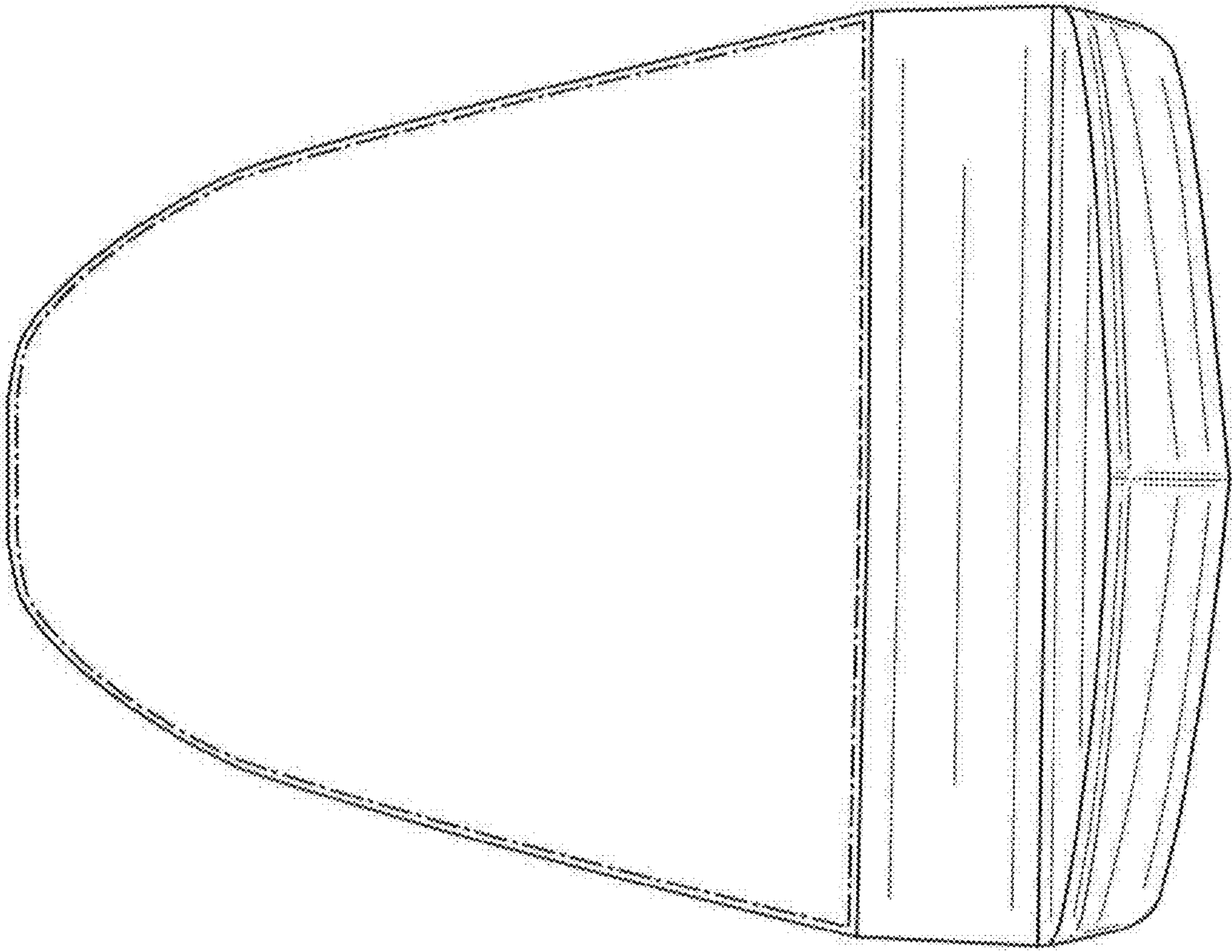

FIG. 13