

US00D708974S

(12) **United States Design Patent**
Dauwalter, III

(10) **Patent No.:** **US D708,974 S**

(45) **Date of Patent:** **** *Jul. 15, 2014**

(54) **DEVICE LOCATOR**

(71) Applicant: **Ray W. Dauwalter, III**, Montpelier, OH
(US)

(72) Inventor: **Ray W. Dauwalter, III**, Montpelier, OH
(US)

(*) Notice: This patent is subject to a terminal disclaimer.

(**) Term: **14 Years**

(21) Appl. No.: **29/442,315**

(22) Filed: **Feb. 4, 2013**

(51) **LOC (10) Cl.** **10-05**

(52) **U.S. Cl.**
USPC **D10/104.1; D10/106.1**

(58) **Field of Classification Search**
USPC D10/46, 46.1, 104.2, 106.6; D14/496;
340/988, 989, 539.13, 539.14, 539.22,
340/539.37; 455/130, 151.1, 352-355;
702/1, 94, 95, 127, 150
See application file for complete search history.

(56) **References Cited**

U.S. PATENT DOCUMENTS

D312,222	S	*	11/1990	Sawyer	D10/106.1
5,289,163	A	*	2/1994	Perez et al.	340/539.32
D345,713	S	*	4/1994	Pecht et al.	D10/106.1
D352,669	S	*	11/1994	Blair	D10/106.1
D372,679	S	*	8/1996	Giannini	D10/106.1
7,565,069	B2	*	7/2009	Huang	396/55

D662,949	S	*	7/2012	Otero et al.	D14/496
8,447,843	B2	*	5/2013	Johnson et al.	709/220
8,519,906	B2	*	8/2013	Richards et al.	343/912
8,600,391	B2	*	12/2013	Vendrow et al.	455/445
8,611,879	B2	*	12/2013	Vendrow et al.	455/417

* cited by examiner

Primary Examiner — Prabhakar Deshmukh

(74) *Attorney, Agent, or Firm* — Paul R. Martin

(57) **CLAIM**

The ornamental design for a device locator, as shown and described.

DESCRIPTION

FIG. 1 is perspective view from the front of the device locator of my new design.

FIG. 2 is a plan view of the front of the locator of my new design.

FIG. 3 is a plan view of the rear of the locator of my new design.

FIG. 4 is a left side elevational view thereof.

FIG. 5 is a right side elevational view thereof.

FIG. 6 is a top plan view thereof.

FIG. 7 is a bottom plan view thereof; and,

FIG. 8 is a perspective view from the rear of the locator of my new design.

The broken lines indicate disclaimed portions and form no part of the claimed design.

1 Claim, 6 Drawing Sheets

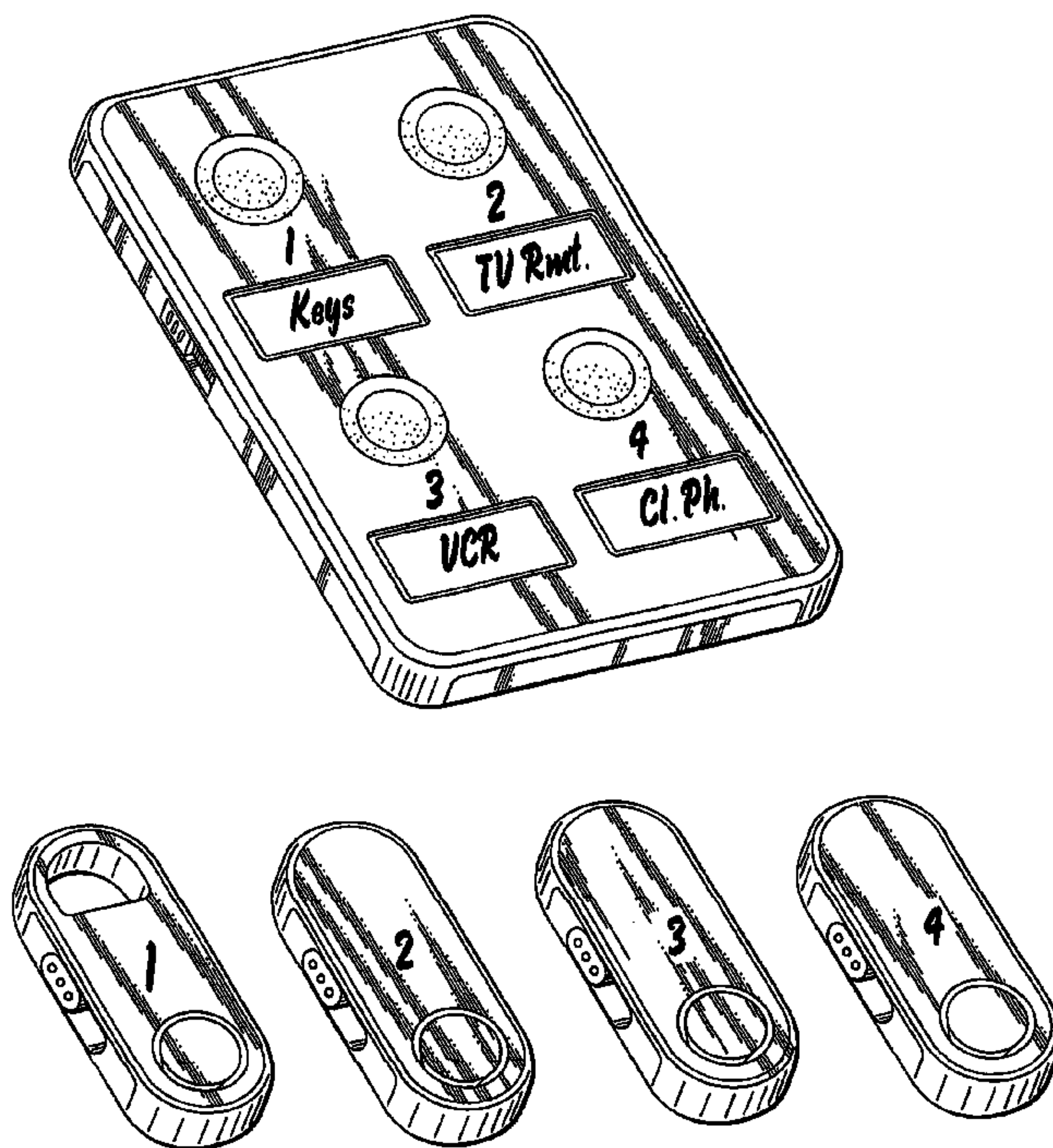

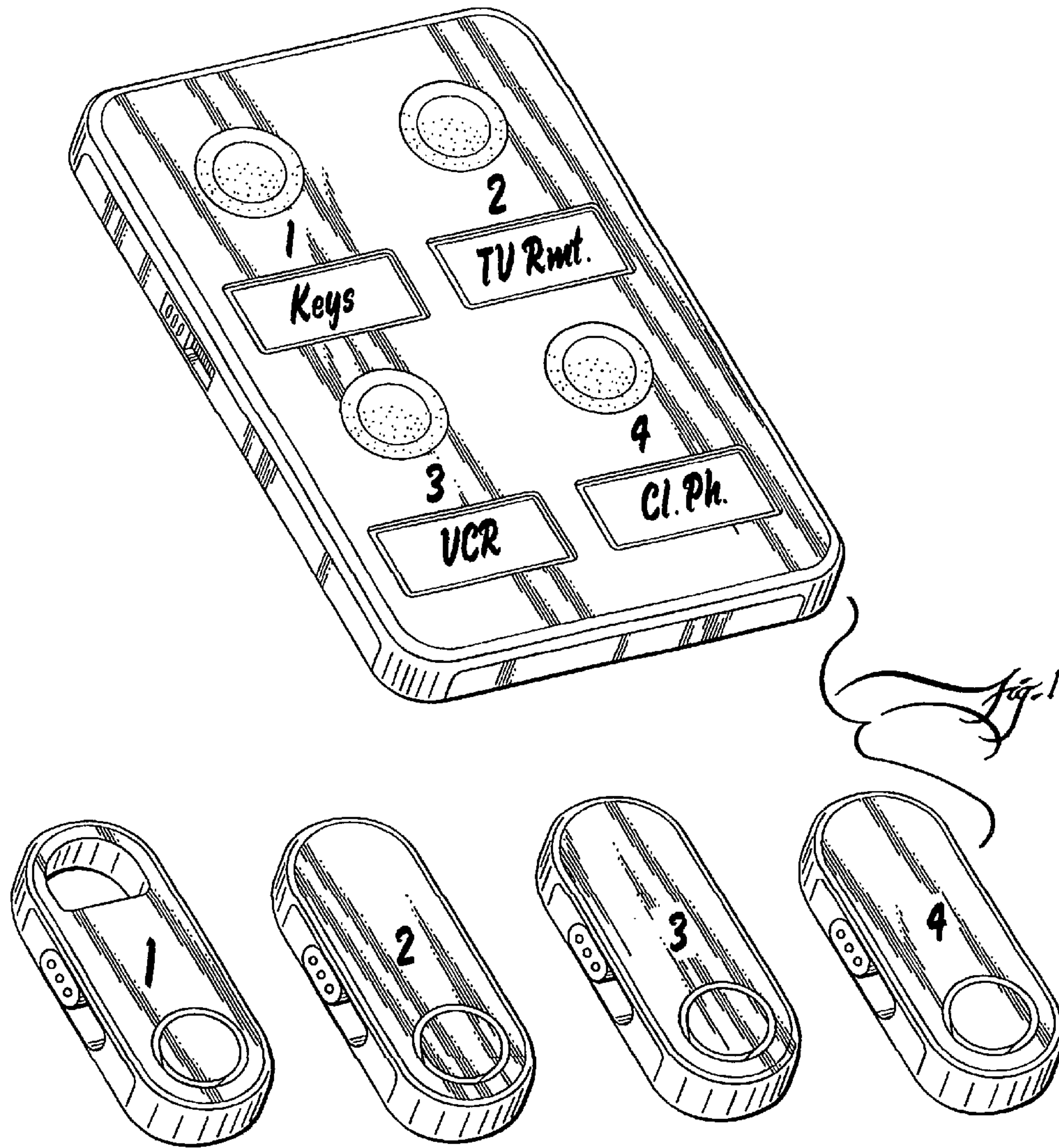

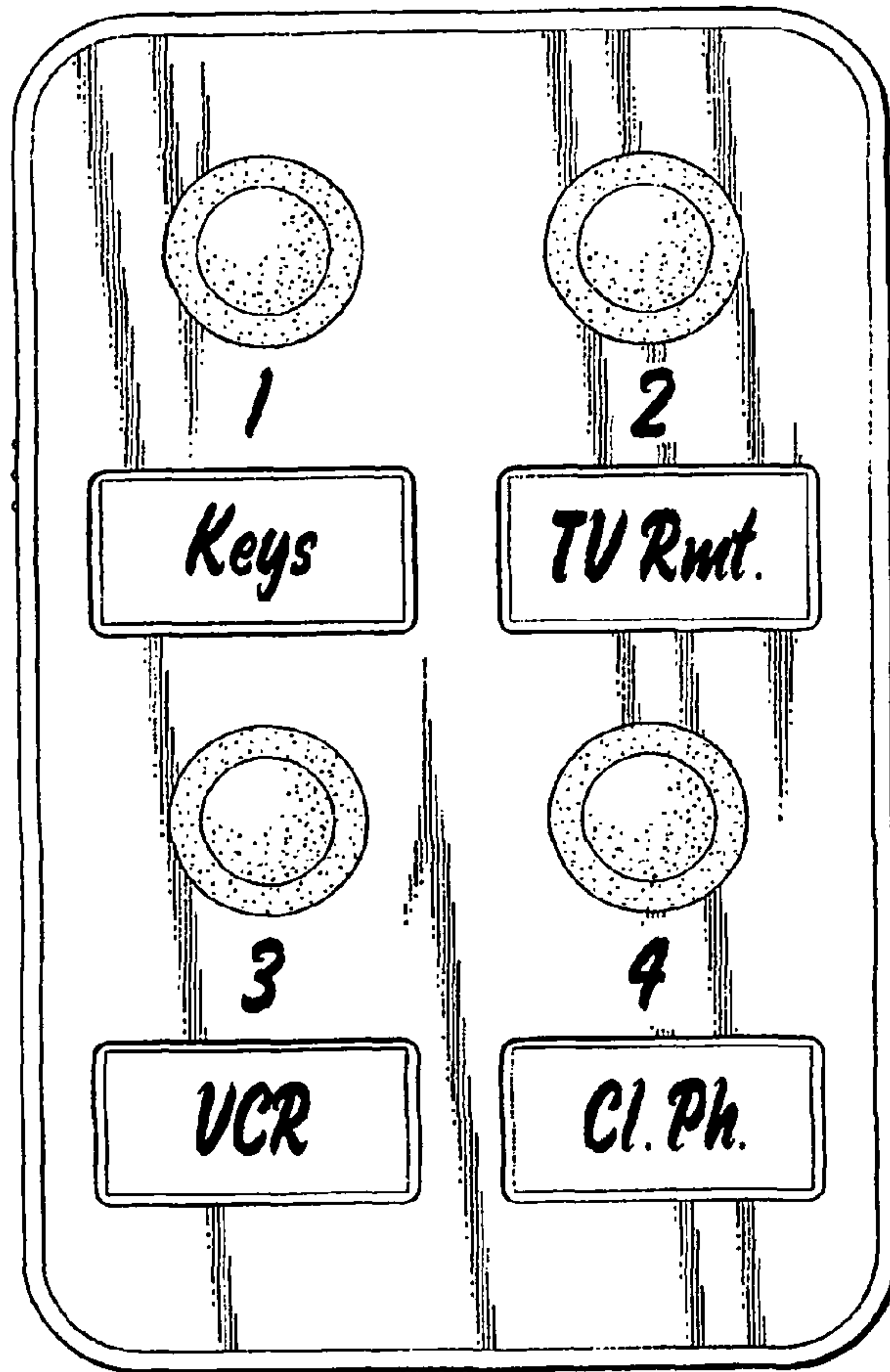
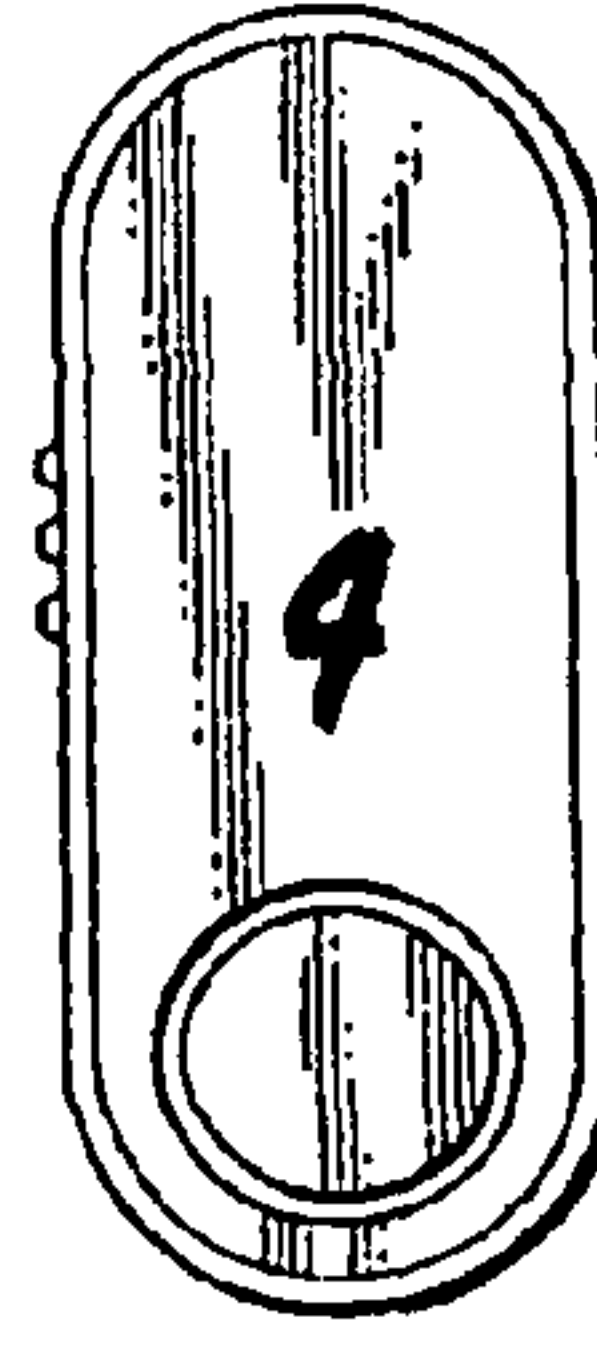
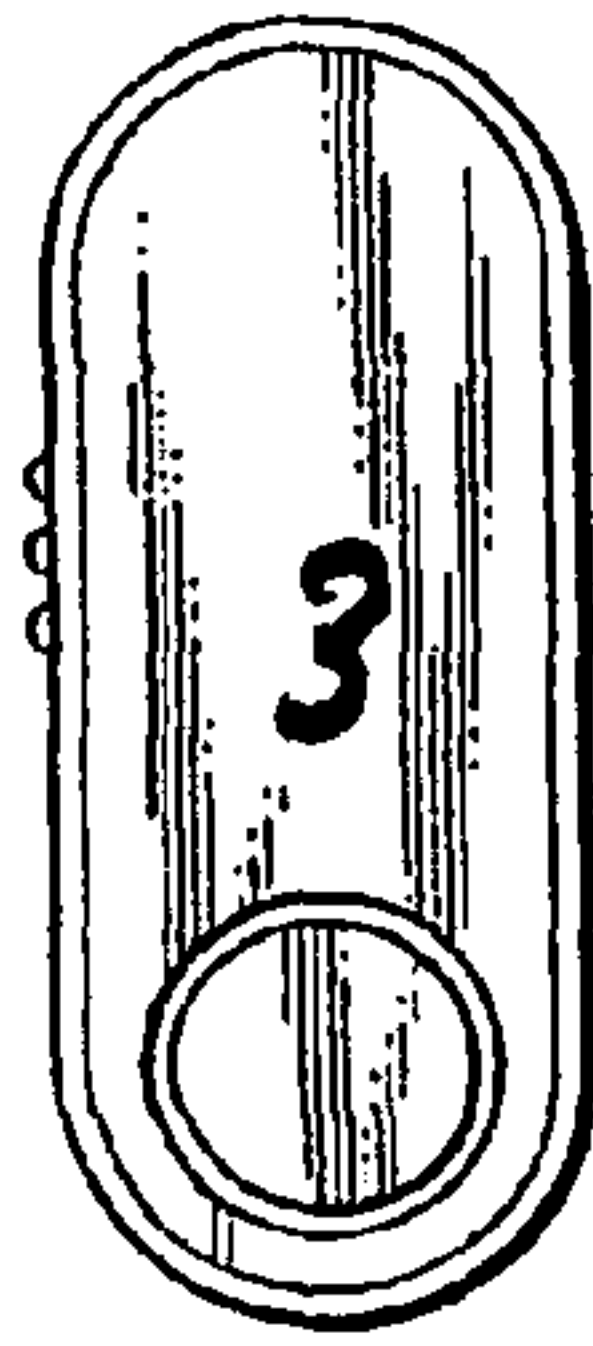
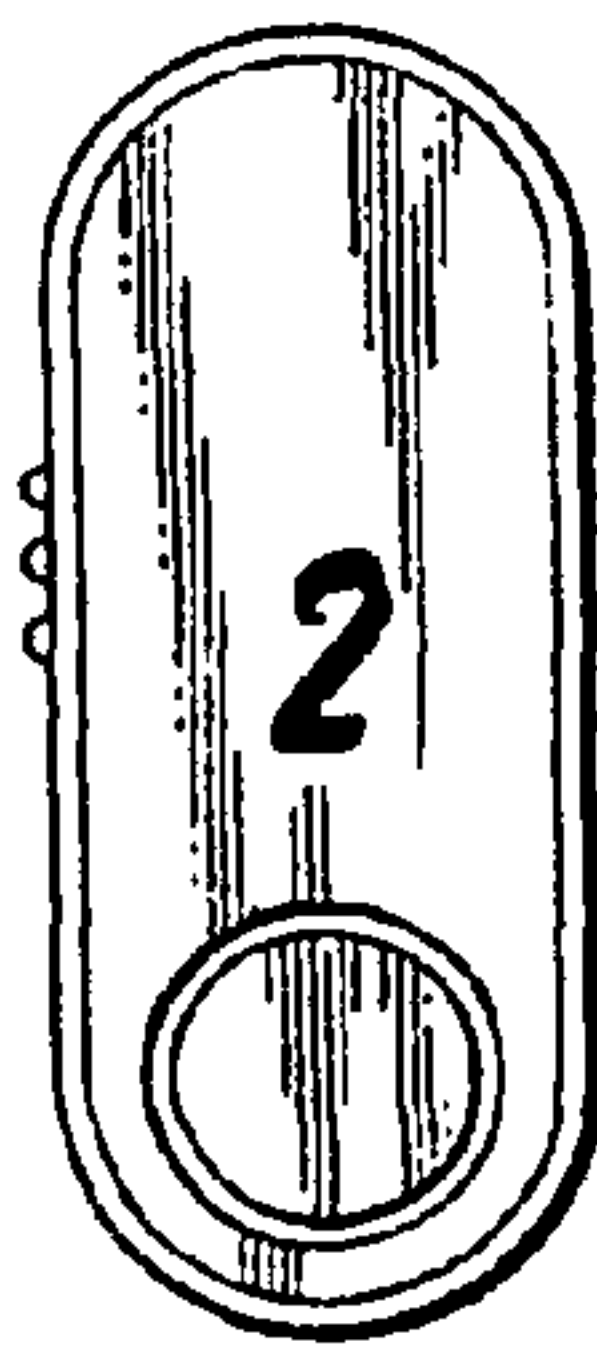
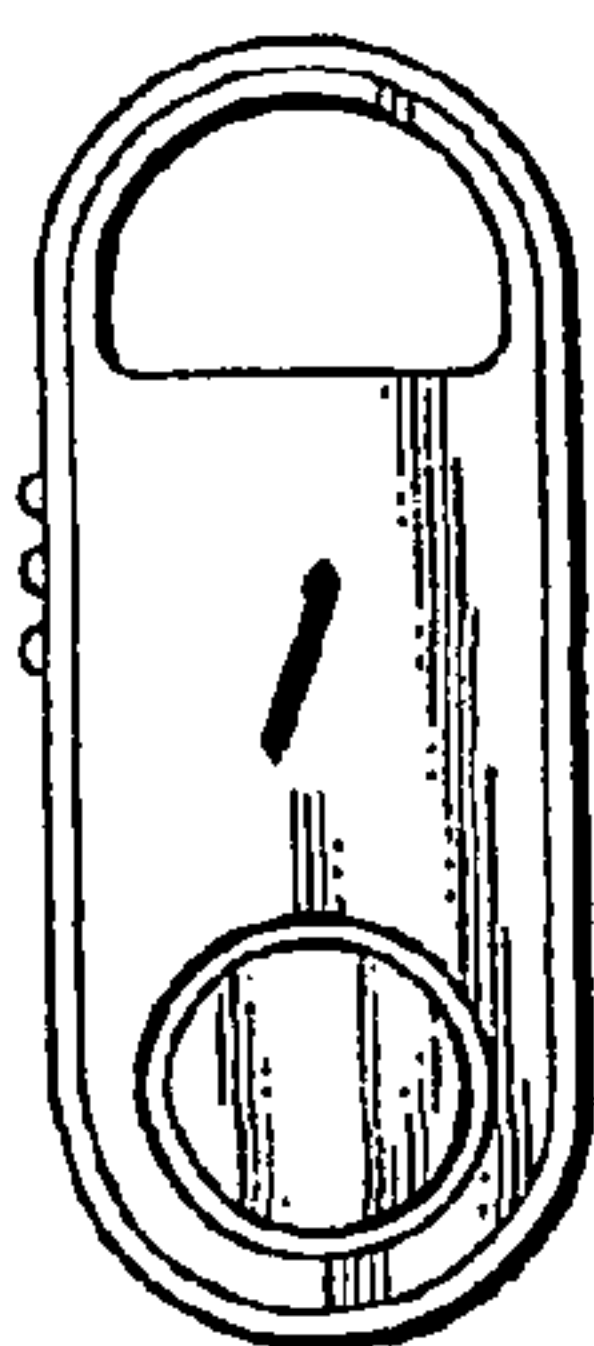

Fig. 2



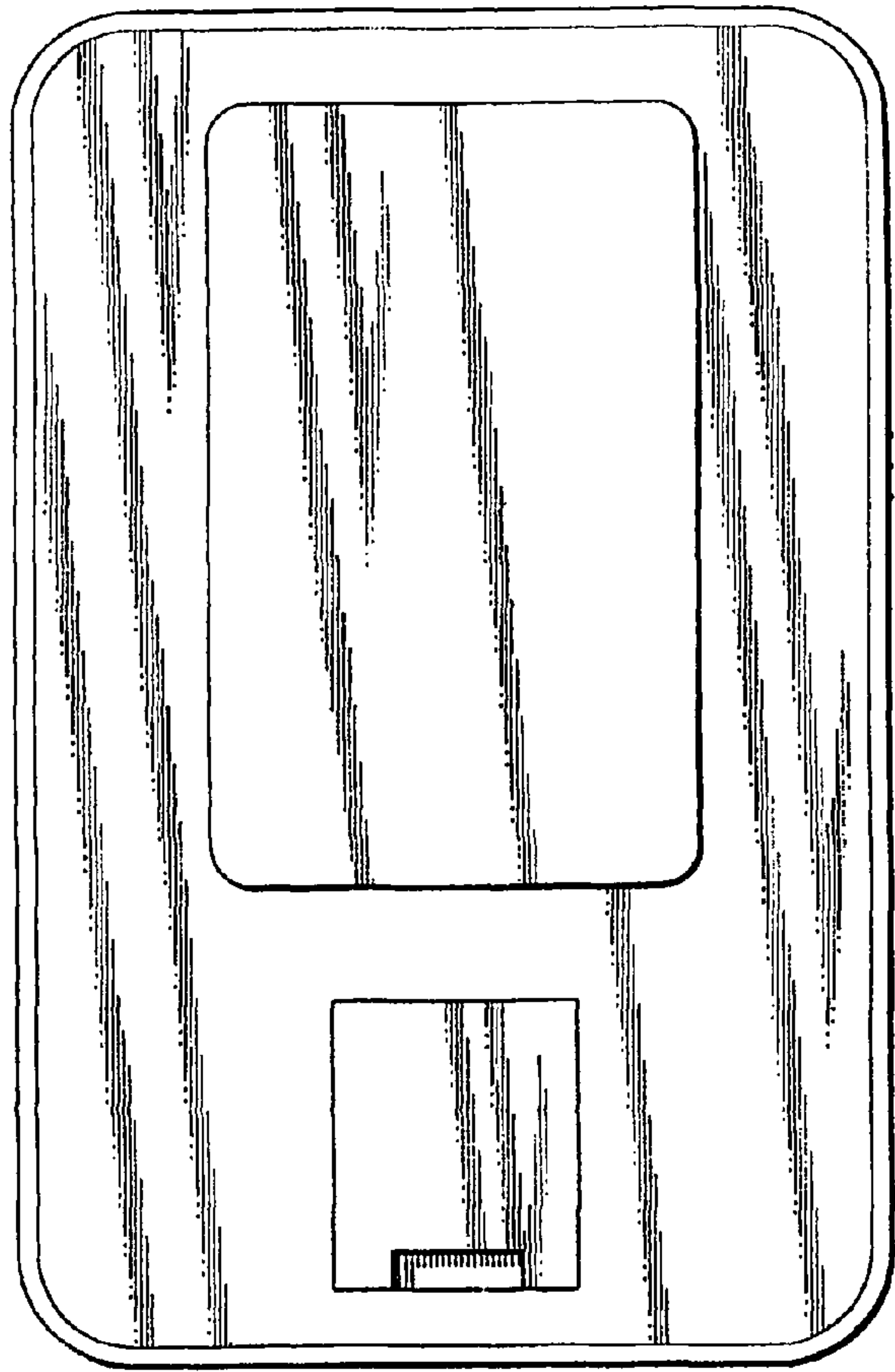
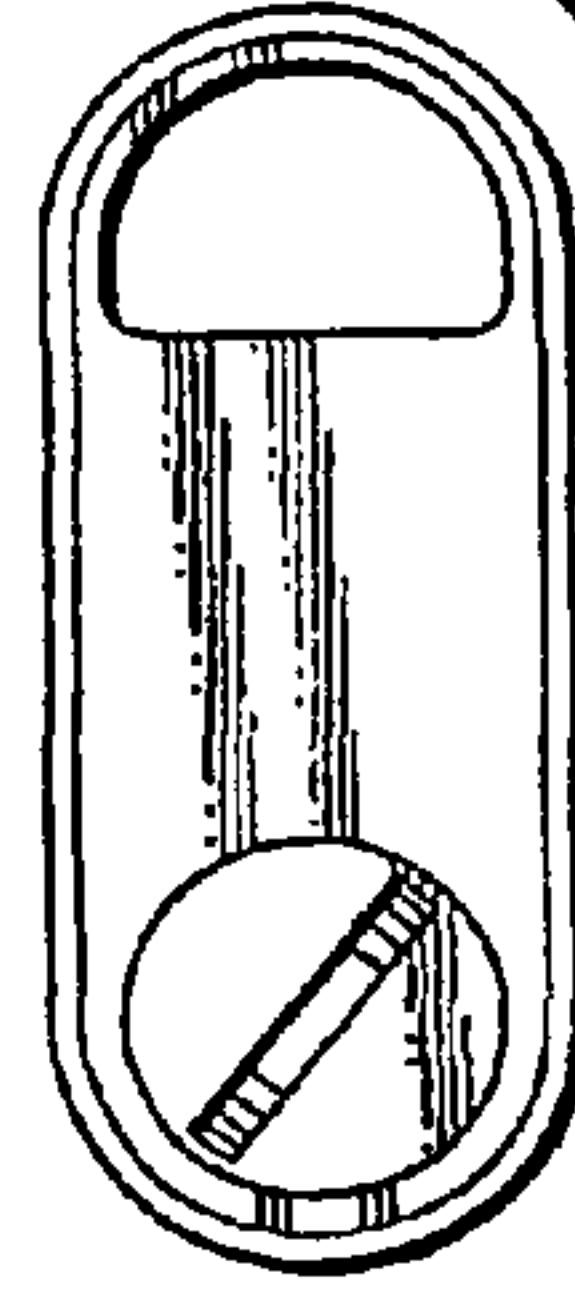
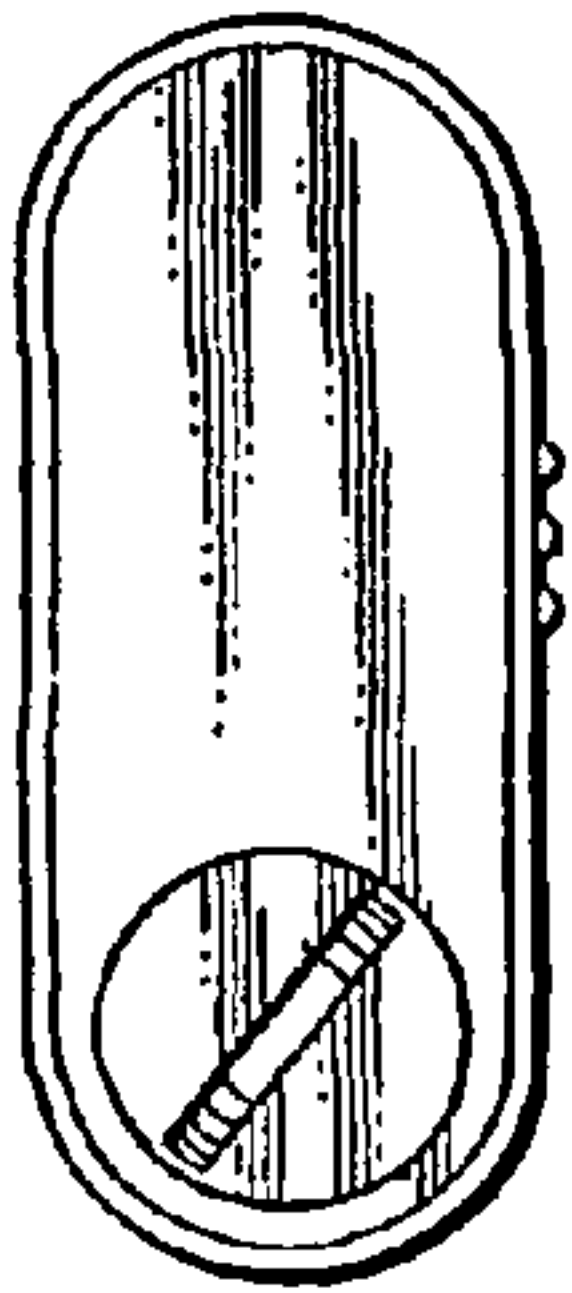
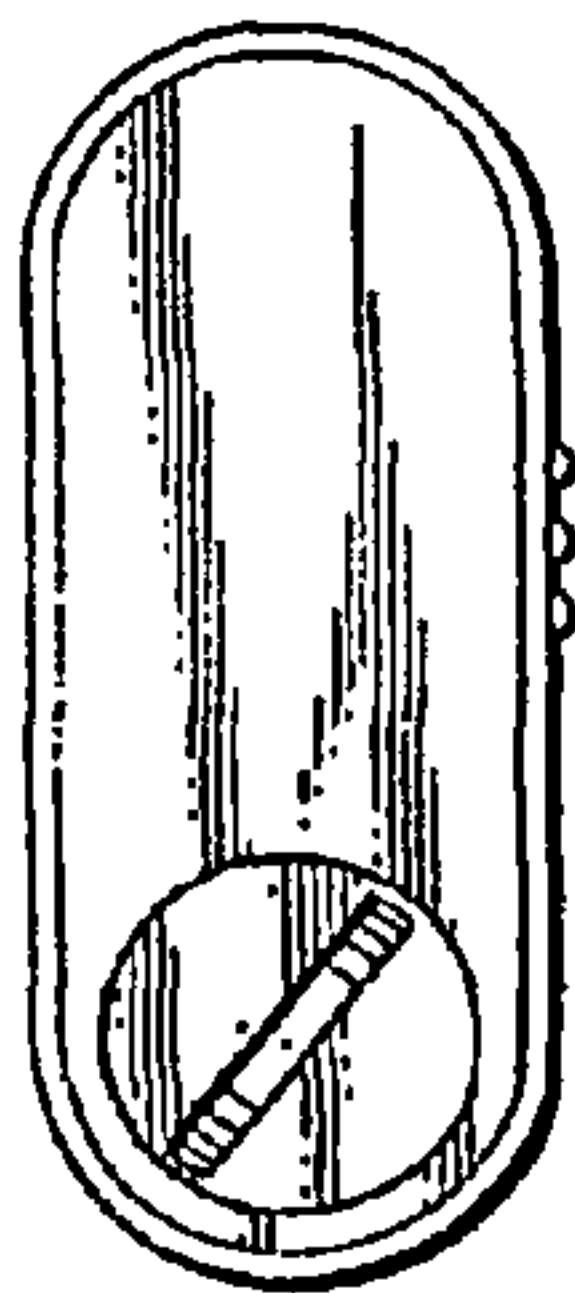
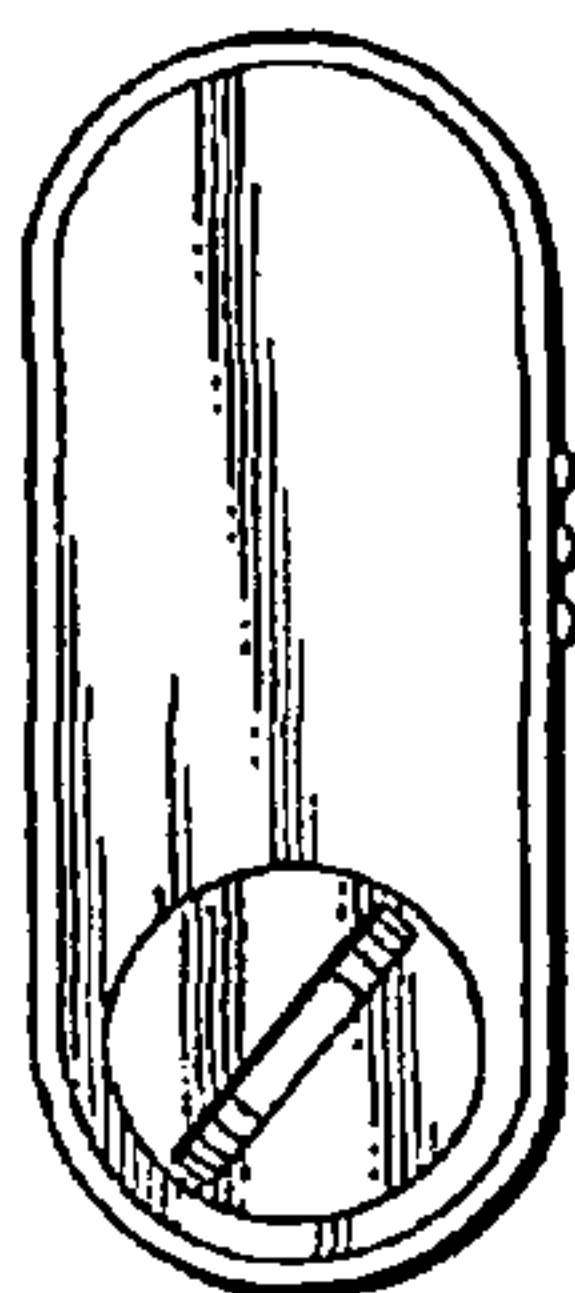

Fig. 3



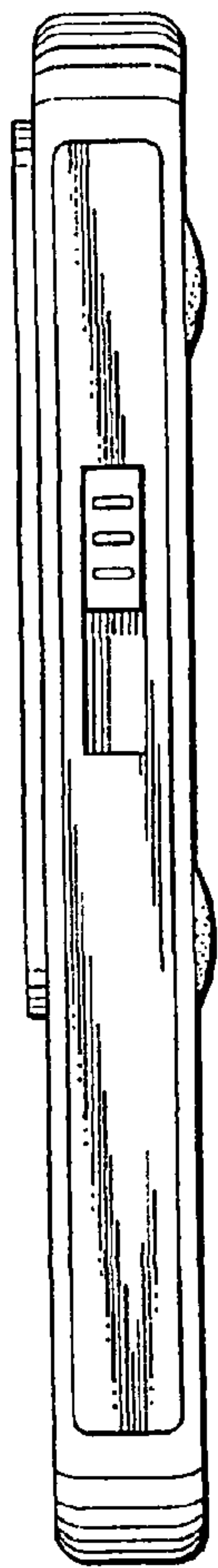

Fig. 4

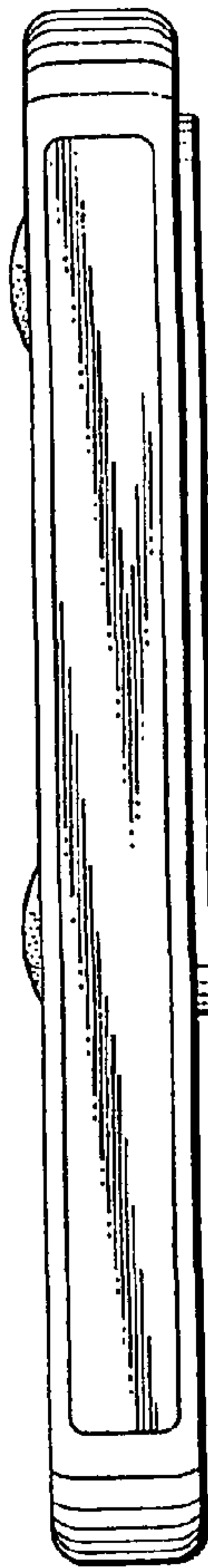
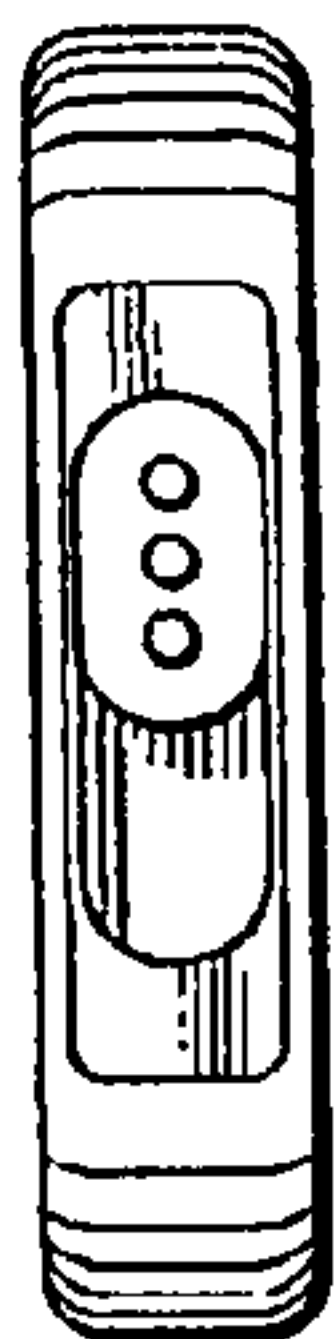

Fig. 5



