



US00D708774S

(12) **United States Design Patent**
Hermansen et al.

(10) **Patent No.:** **US D708,774 S**

(45) **Date of Patent:** **** Jul. 8, 2014**

(54) **LIGHT POST VERTICAL MOUNT**

(56) **References Cited**

(71) Applicants: **Jonathan Hermansen**, Oswego, IL
(US); **Mohan B. Rao**, Schaumburg, IL
(US); **Steven Walczak**, Kenosha, WI
(US)

(72) Inventors: **Jonathan Hermansen**, Oswego, IL
(US); **Mohan B. Rao**, Schaumburg, IL
(US); **Steven Walczak**, Kenosha, WI
(US)

(73) Assignee: **Sternberg Lanterns, Inc.**, Roselle, IL
(US)

(**) Term: **14 Years**

(21) Appl. No.: **29/455,234**

(22) Filed: **May 17, 2013**

(51) **LOC (10) Cl.** **26-05**

(52) **U.S. Cl.**
USPC **D26/71**

(58) **Field of Classification Search**
CPC F21S 8/085; F21S 8/086; F21S 8/088;
F21V 21/14
USPC D26/67-71, 92; 362/249.01, 249.02,
362/235-237, 157, 183, 431, 432
See application file for complete search history.

U.S. PATENT DOCUMENTS

| | | | | | | |
|-----------|----|---|---------|-------------------|-------|---------|
| D622,889 | S | * | 8/2010 | Zheng | | D26/71 |
| D636,107 | S | * | 4/2011 | Compton | | D26/71 |
| 8,070,311 | B2 | * | 12/2011 | Lu et al. | | 362/183 |
| D656,267 | S | * | 3/2012 | Laporte | | D26/120 |
| D664,697 | S | * | 7/2012 | Piano | | D26/71 |
| D666,347 | S | * | 8/2012 | Kim et al. | | D26/71 |
| D680,258 | S | * | 4/2013 | Ahrari et al. | | D26/92 |
| D680,259 | S | * | 4/2013 | Ahrari et al. | | D26/92 |
| D688,404 | S | * | 8/2013 | Boissevain et al. | | D26/71 |
| D689,233 | S | * | 9/2013 | Boissevain et al. | | D26/71 |
| D693,513 | S | * | 11/2013 | Nibaldi | | D26/71 |
| D698,967 | S | * | 2/2014 | Rangesh et al. | | D26/71 |

* cited by examiner

Primary Examiner — Clare E Heflin

(74) *Attorney, Agent, or Firm* — Seyfarth Shaw LLP

(57) **CLAIM**

The ornamental design for a light post vertical mount, as shown and described.

DESCRIPTION

FIG. 1 is a perspective side view of an embodiment of a light post vertical mount;
FIG. 2 is a front view thereof;
FIG. 3 is a rear view thereof.
FIG. 4 is a left side view thereof;
FIG. 5 is a right side view thereof;
FIG. 6 is a top view thereof; and,
FIG. 7 is a bottom view thereof.

1 Claim, 5 Drawing Sheets

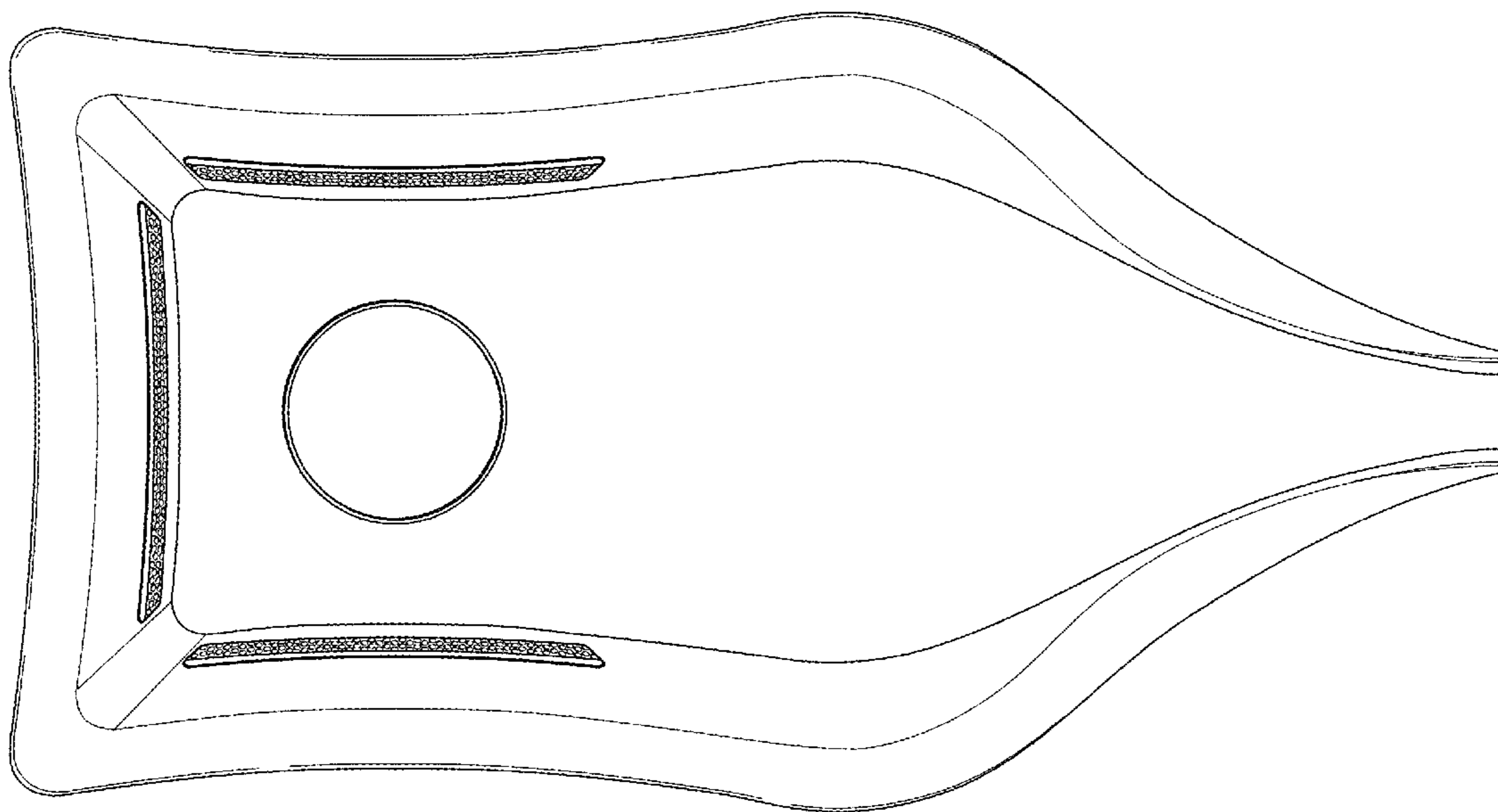

Fig. 1

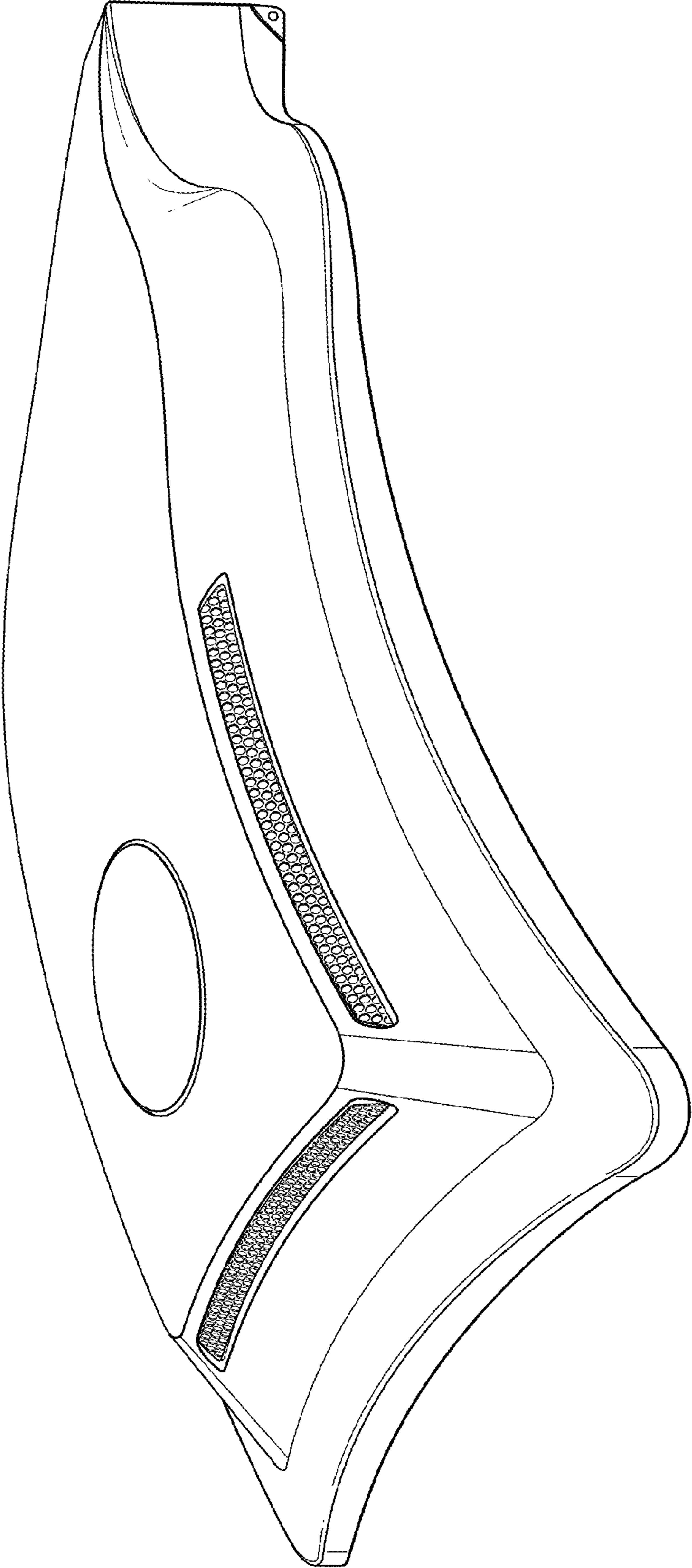

Fig. 2

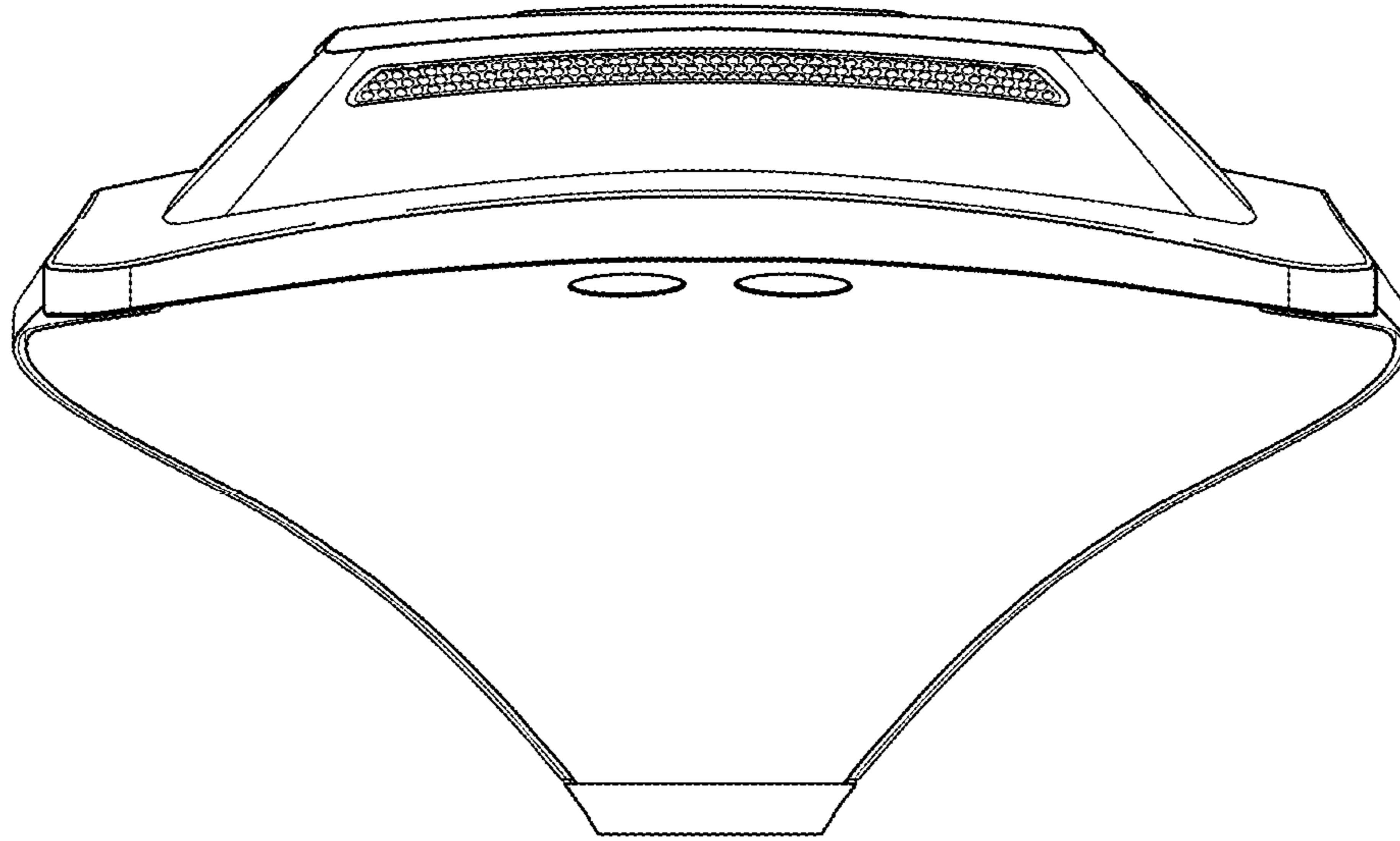
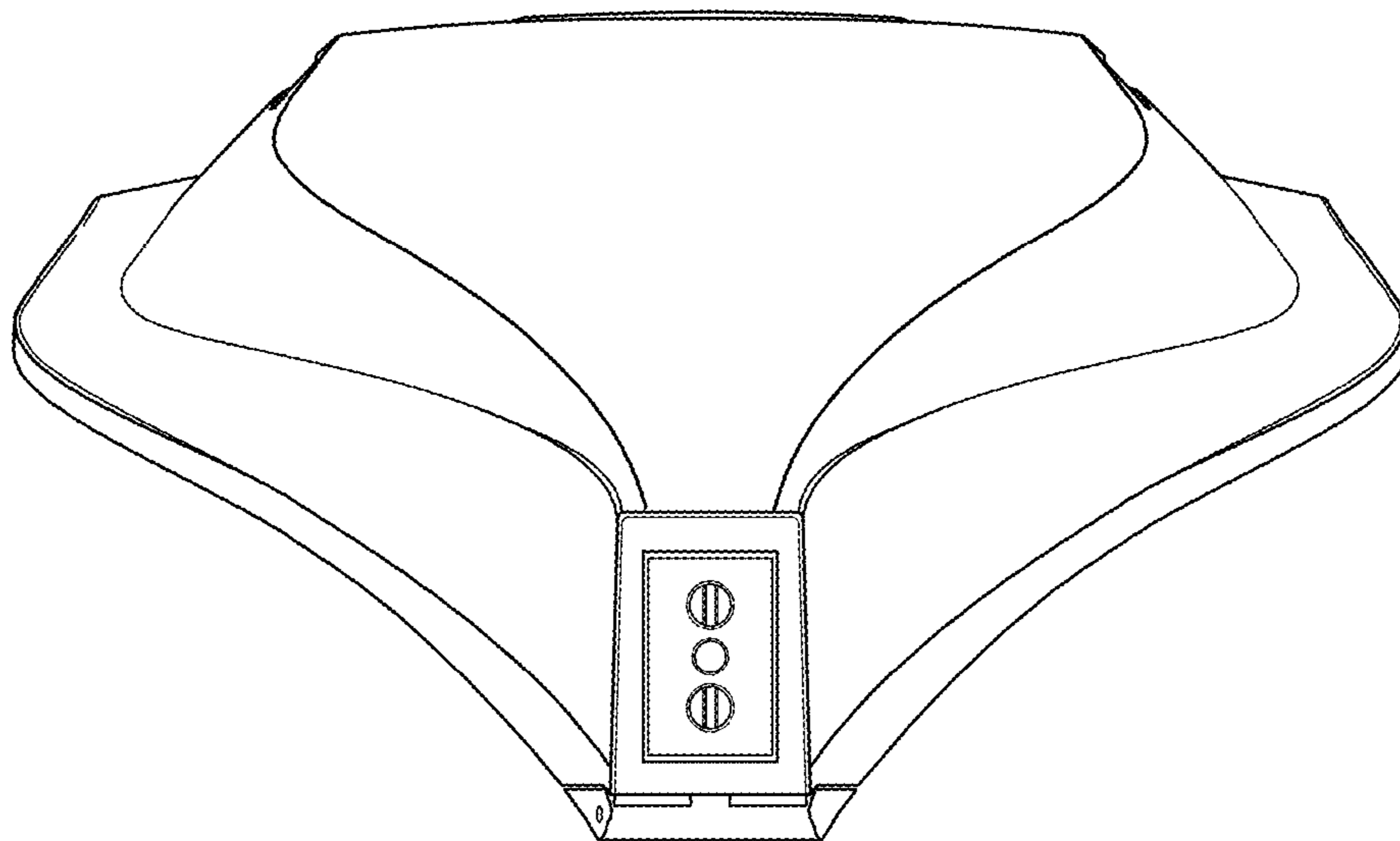

Fig. 3



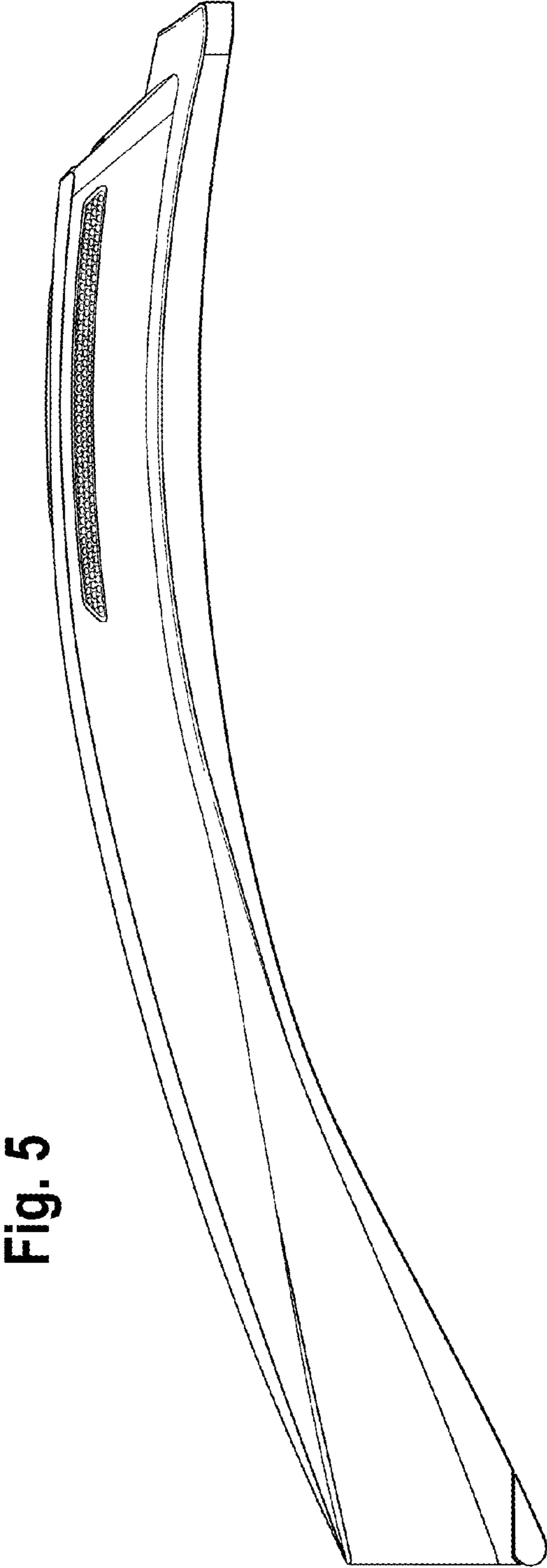
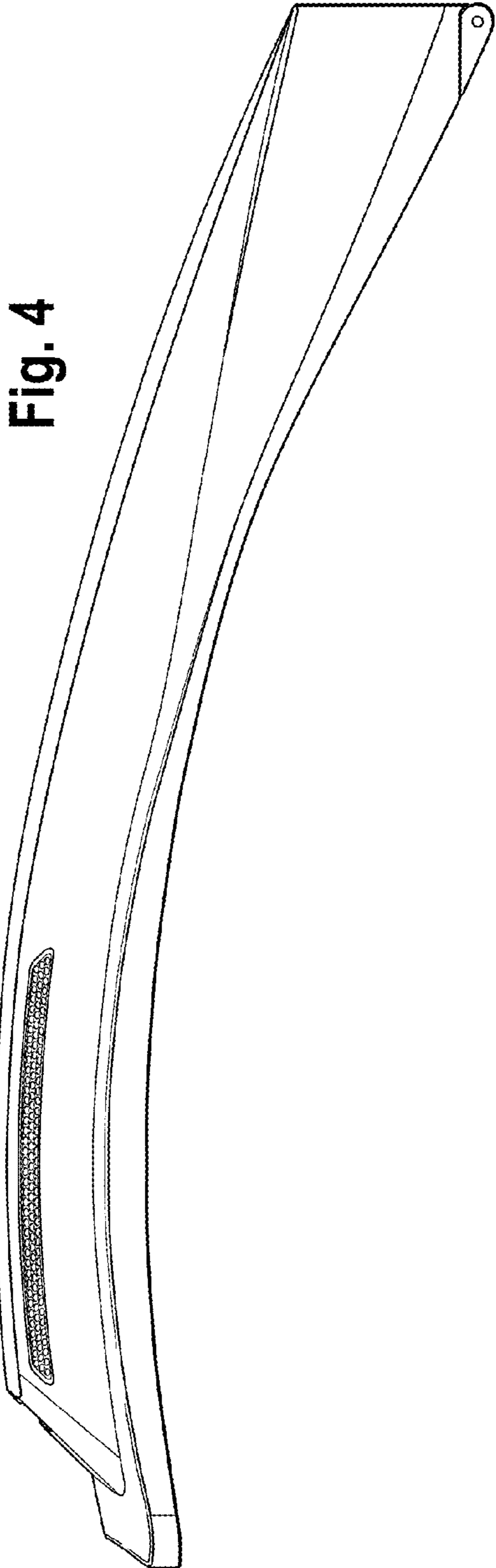
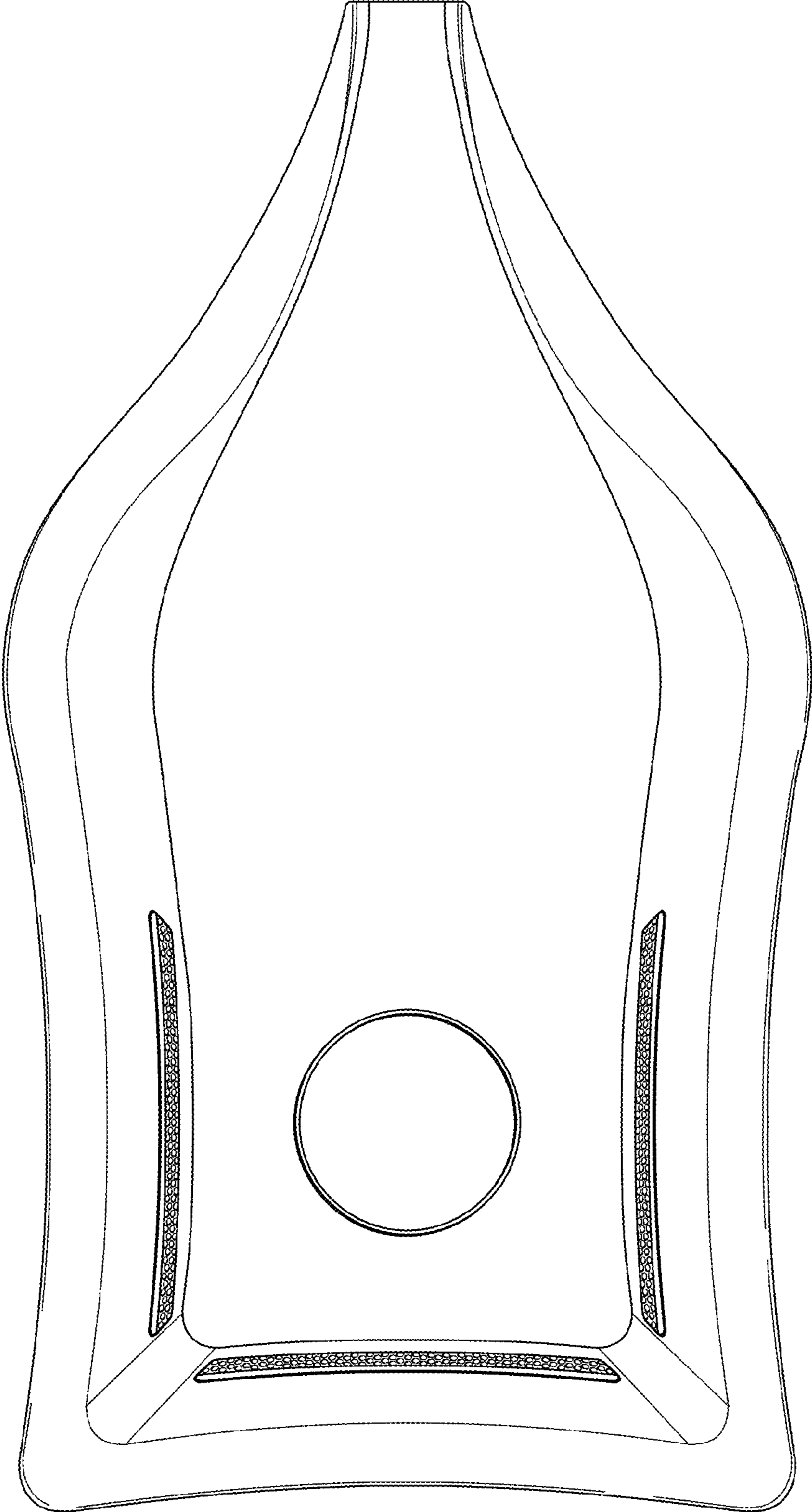

Fig. 6



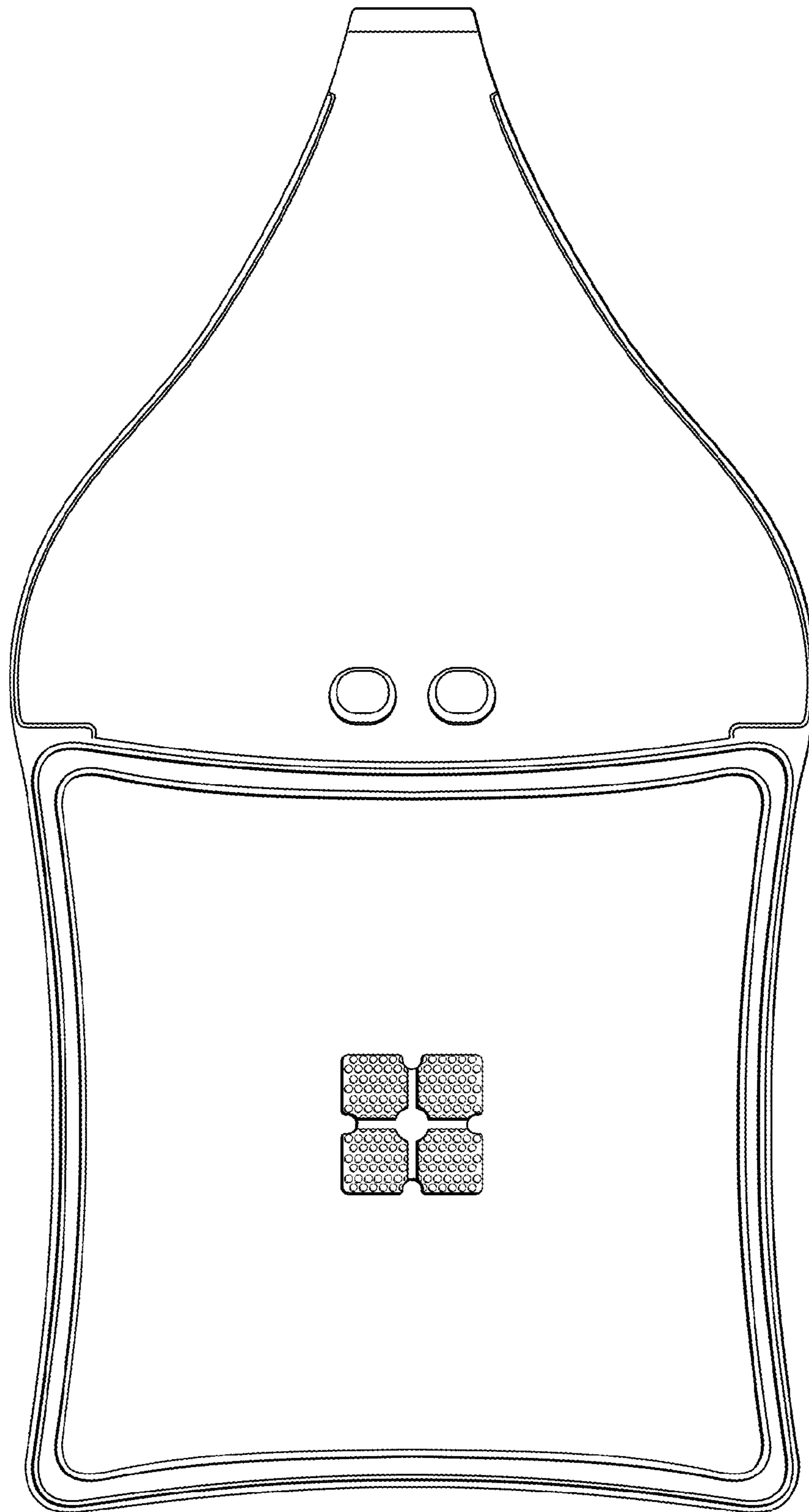

Fig. 7