



US00D708743S

(12) **United States Design Patent**
Wikstroem Shemer et al.

(10) **Patent No.:** **US D708,743 S**

(45) **Date of Patent:** **** Jul. 8, 2014**

(54) **COLPOSCOPE**

(71) Applicant: **Gynius AB**, Stockholm (SE)

(72) Inventors: **Elisabeth Wikstroem Shemer**,
Stockholm (SE); **Isaac Shemer**,
Stockholm (SE); **Matthew Volsky**,
Stockholm (SE)

(73) Assignee: **Gynius AB**, Stockholm (SE)

(**) Term: **14 Years**

(21) Appl. No.: **29/437,256**

(22) Filed: **Nov. 14, 2012**

(51) **LOC (10) Cl.** **24-02**

(52) **U.S. Cl.**
USPC **D24/137**

(58) **Field of Classification Search**
USPC D24/138, 137, 133, 135, 140;
600/101-183

See application file for complete search history.

(56) **References Cited**

U.S. PATENT DOCUMENTS

3,994,288	A	*	11/1976	Stumpf	600/109
5,791,346	A	*	8/1998	Craine et al.	600/407
D416,088	S	*	11/1999	Krauter et al.	D24/137
6,088,612	A	*	7/2000	Blair	600/407
D434,147	S	*	11/2000	Ward et al.	D24/137
D457,628	S	*	5/2002	Eggers et al.	D24/144
D457,960	S	*	5/2002	Eggers et al.	D24/144

D530,818	S	*	10/2006	Lin	D24/138
D581,051	S	*	11/2008	Melder	D24/138
D639,428	S	*	6/2011	Yasue et al.	D24/137
D663,344	S	*	7/2012	Yasue et al.	D16/219

* cited by examiner

Primary Examiner — Bridget L Eland

(74) *Attorney, Agent, or Firm* — ARC IPLAW, PC; Joseph J. Mayo

(57) **CLAIM**

The ornamental design for a colposcope, as shown and described.

DESCRIPTION

FIG. 1 is a right upper perspective view of a colposcope.
 FIG. 2 is a left front perspective view of the colposcope.
 FIG. 3 is a left lower perspective view of the colposcope.
 FIG. 4 is a left front lower perspective view of the colposcope.
 FIG. 5 is a left view of the colposcope.
 FIG. 6 is a right view of the colposcope.
 FIG. 7A is a first embodiment of a front view of the colposcope.
 FIG. 7B is a second embodiment of the front view of the colposcope.
 FIG. 8 is a rear view of the colposcope.
 FIG. 9 is a top view of the colposcope; and
 FIG. 10 is a bottom view of the colposcope.

The broken lines immediately adjacent the shaded areas represent the bounds of the claimed design while all other broken lines are directed to environment and are for illustrative purposes only; the broken lines form no part of the claimed design.

1 Claim, 11 Drawing Sheets

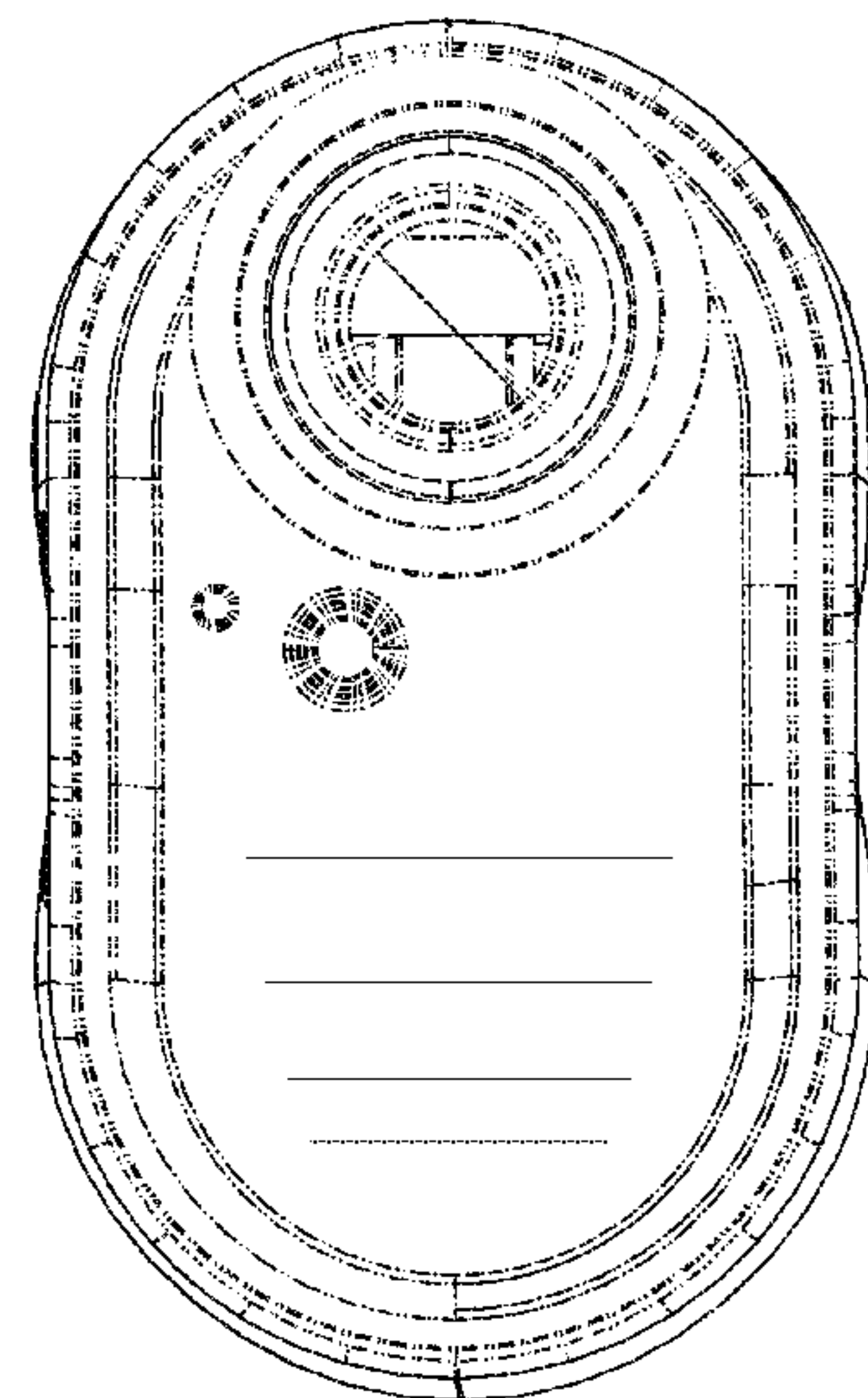
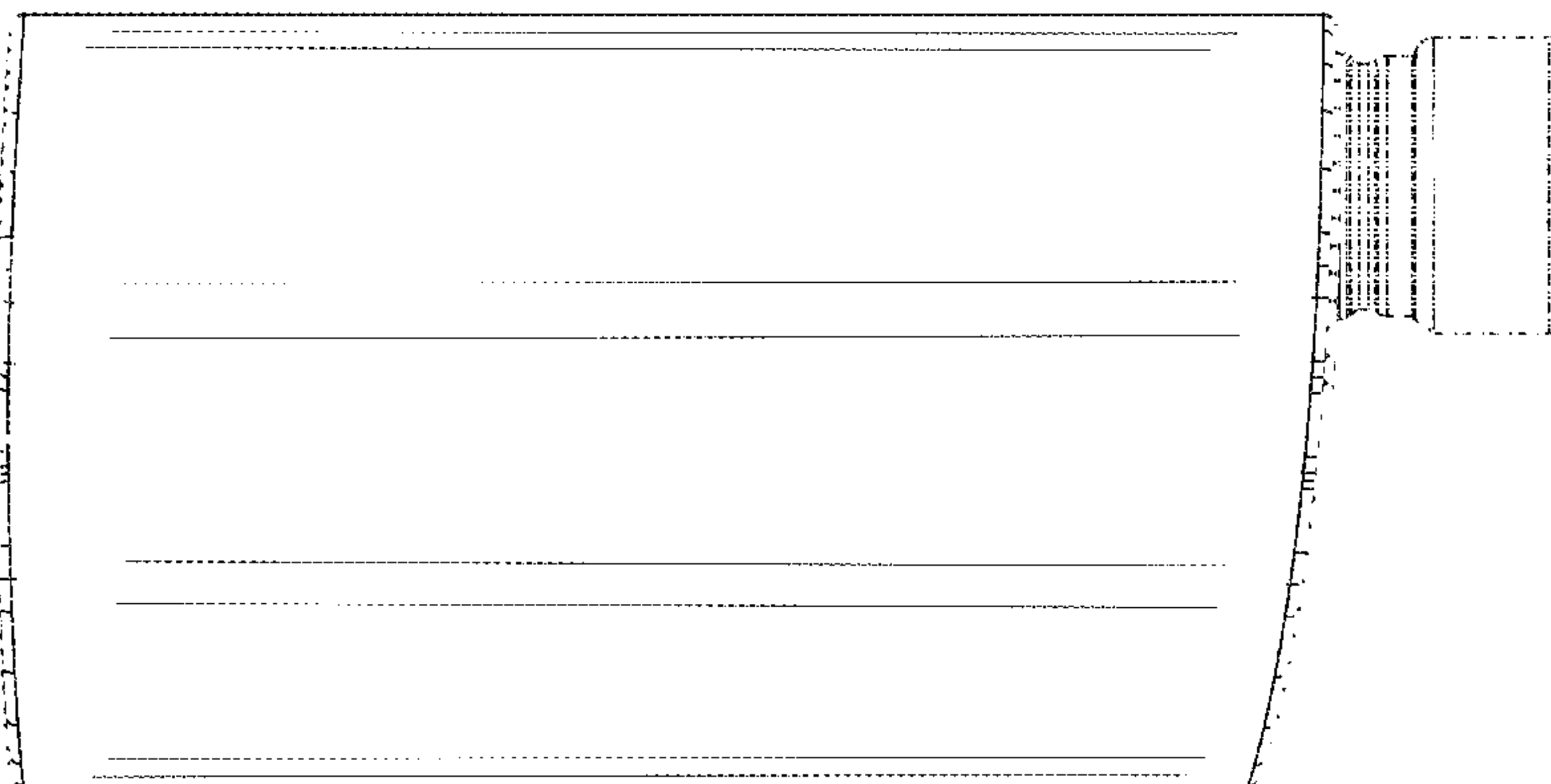

FIGURE 1

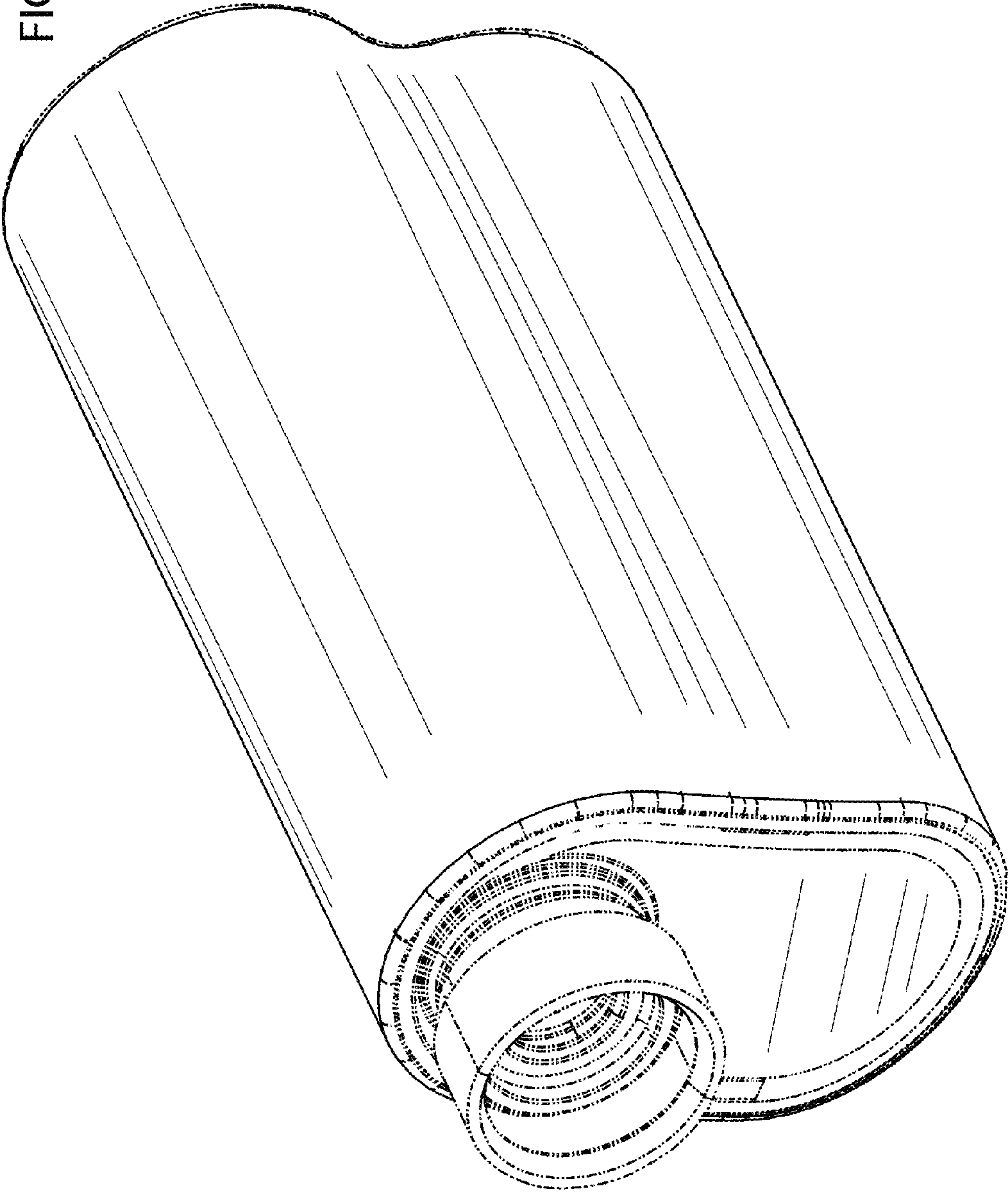

FIGURE 2

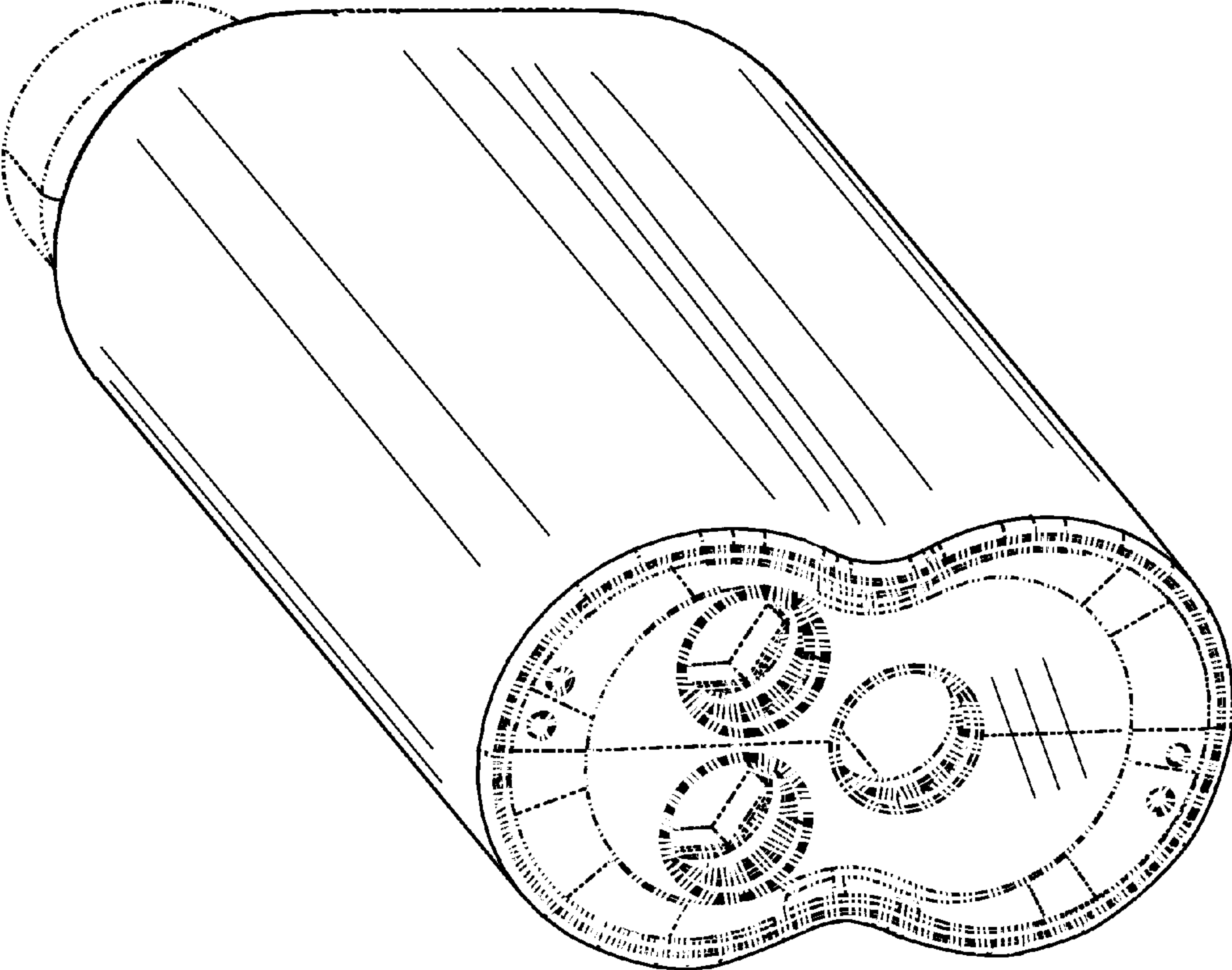

FIGURE 3

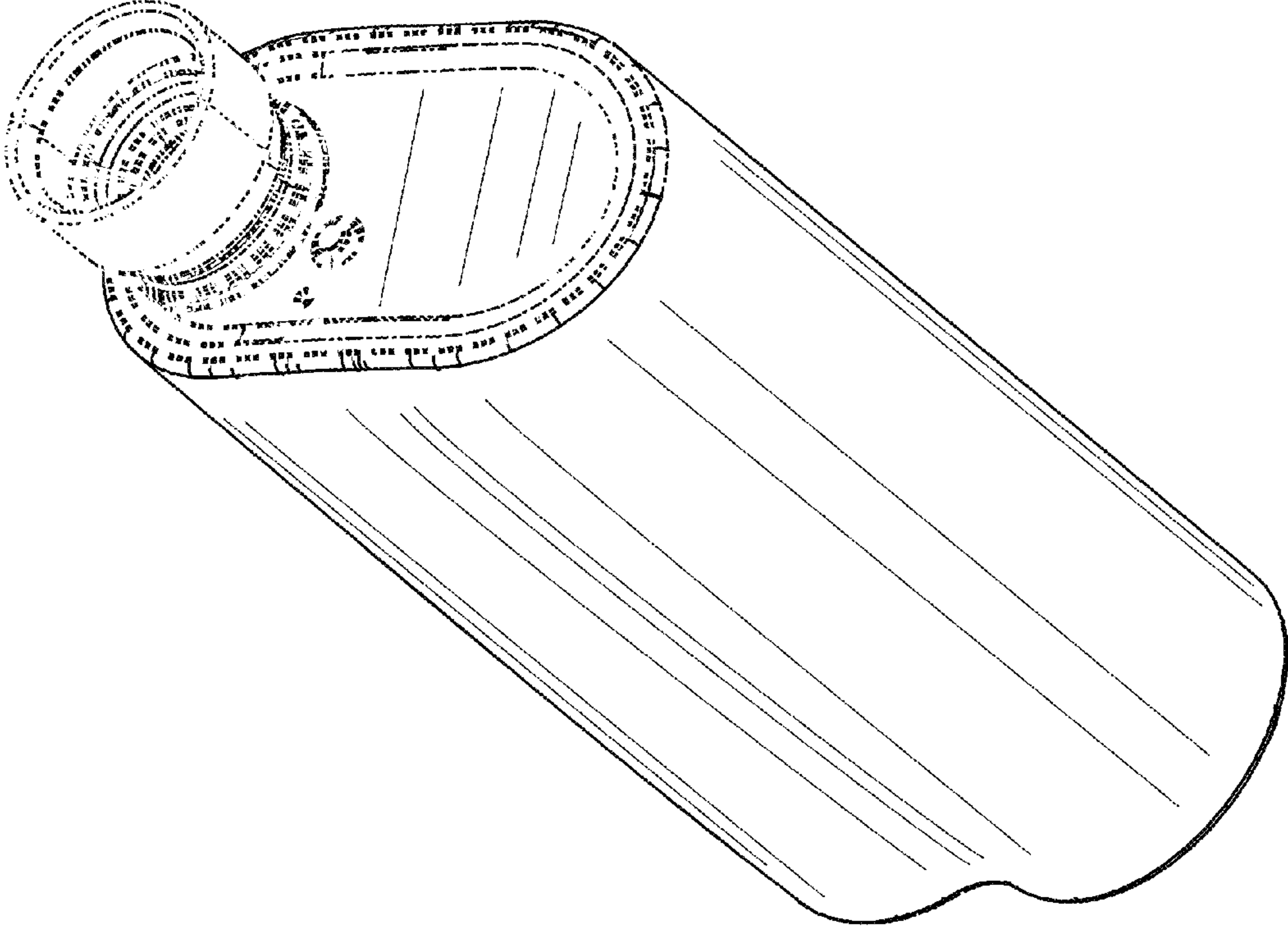

FIGURE 4

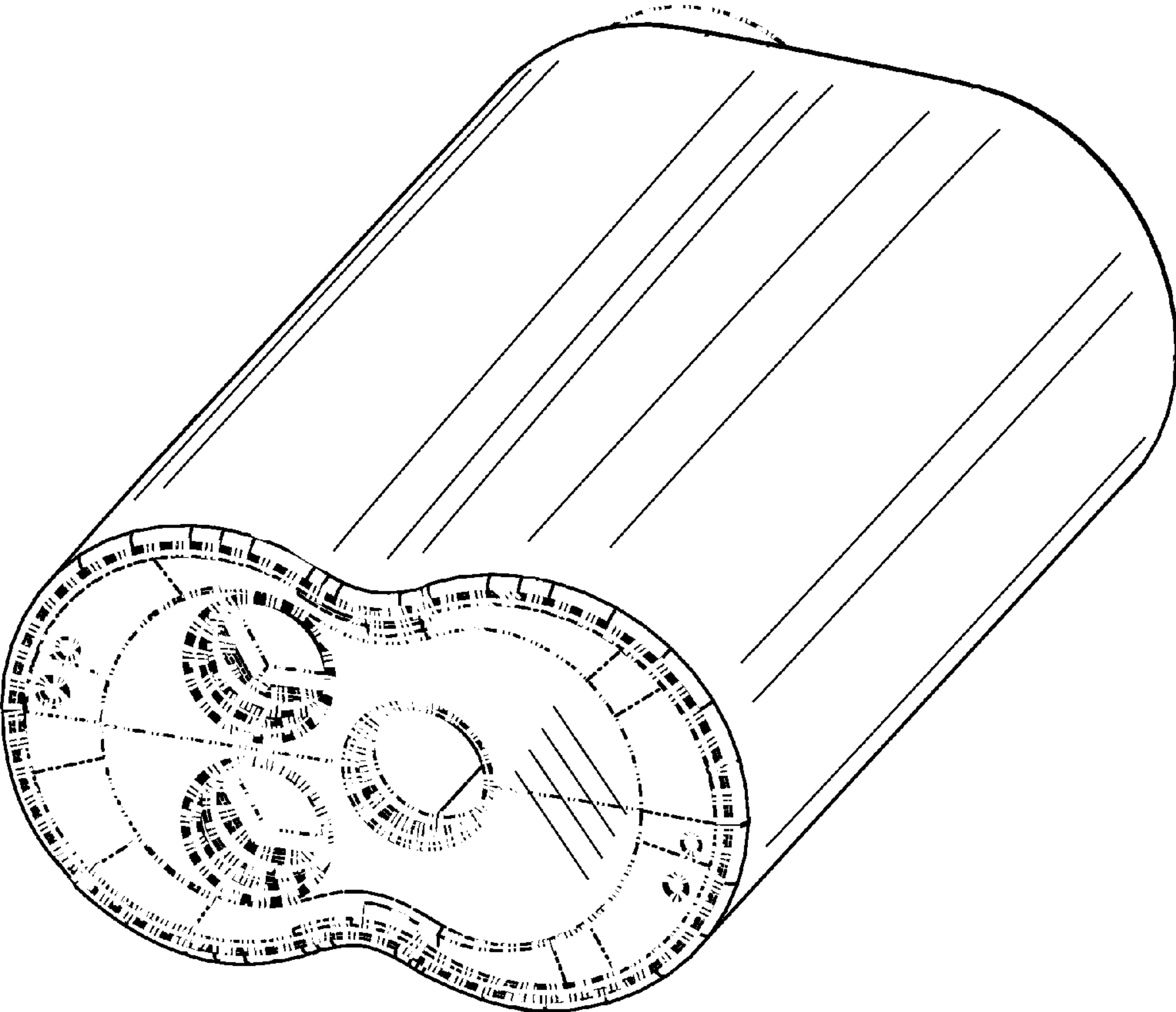

FIGURE 5

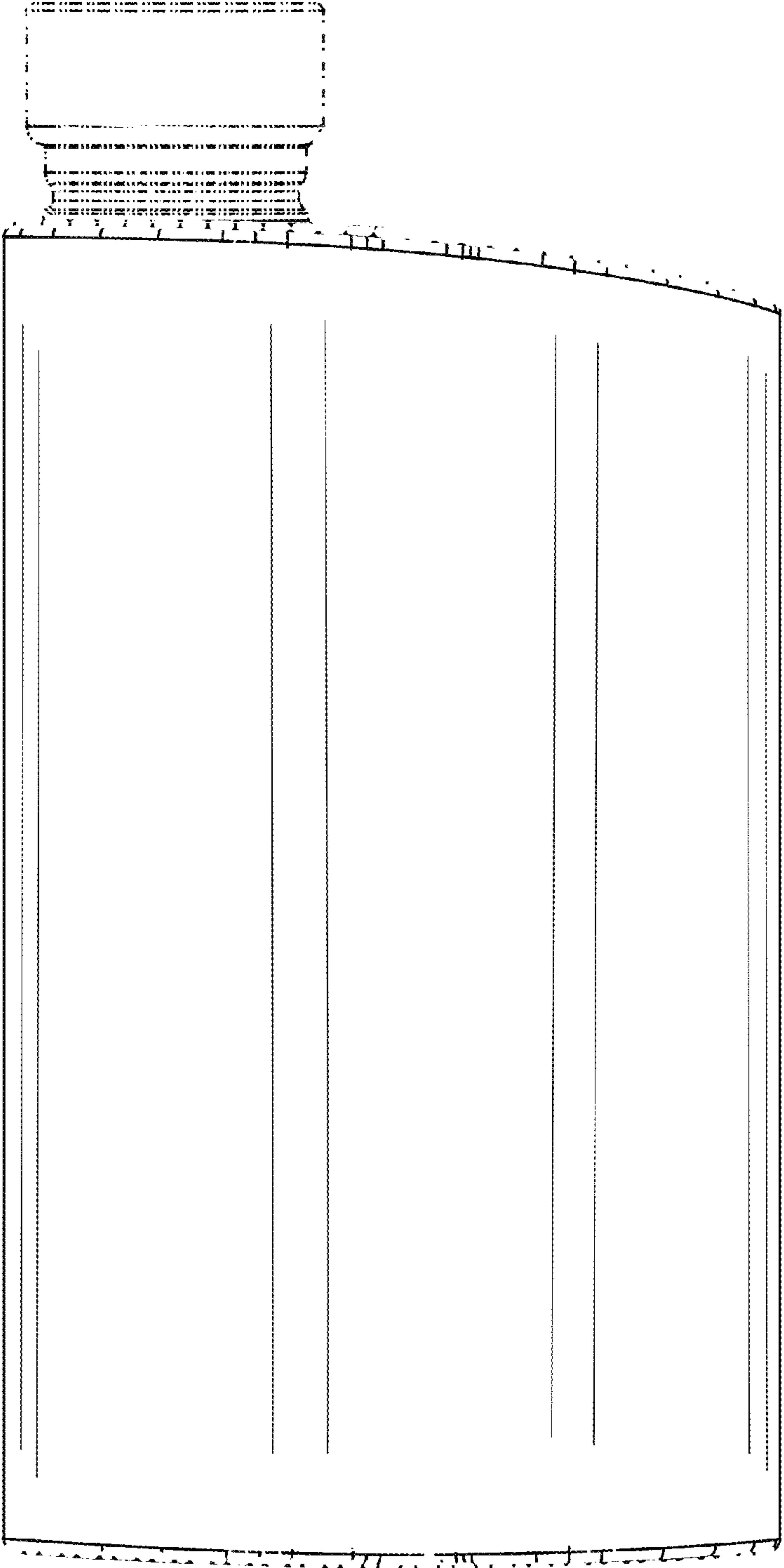

FIGURE 6

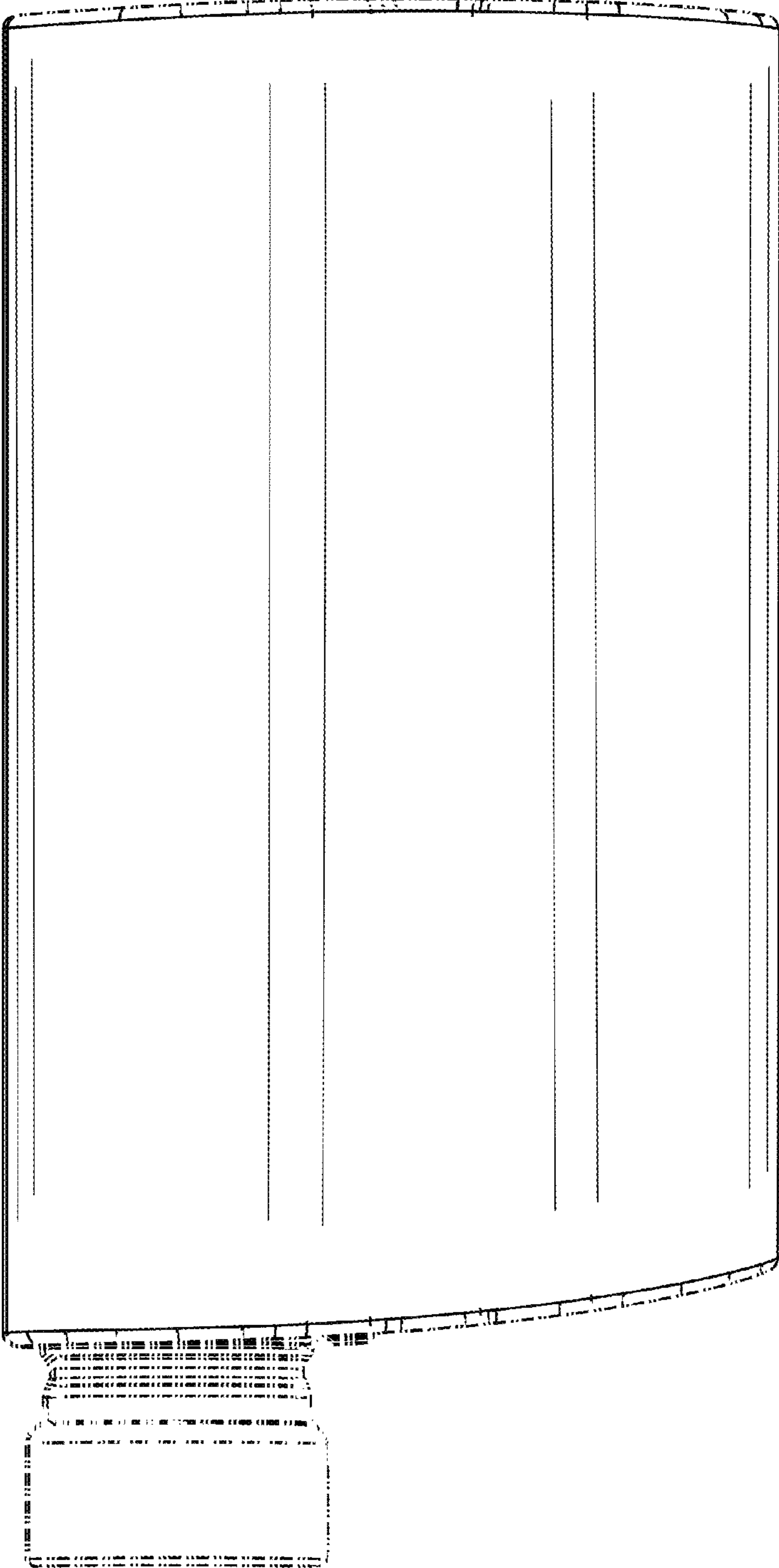

FIGURE 7A

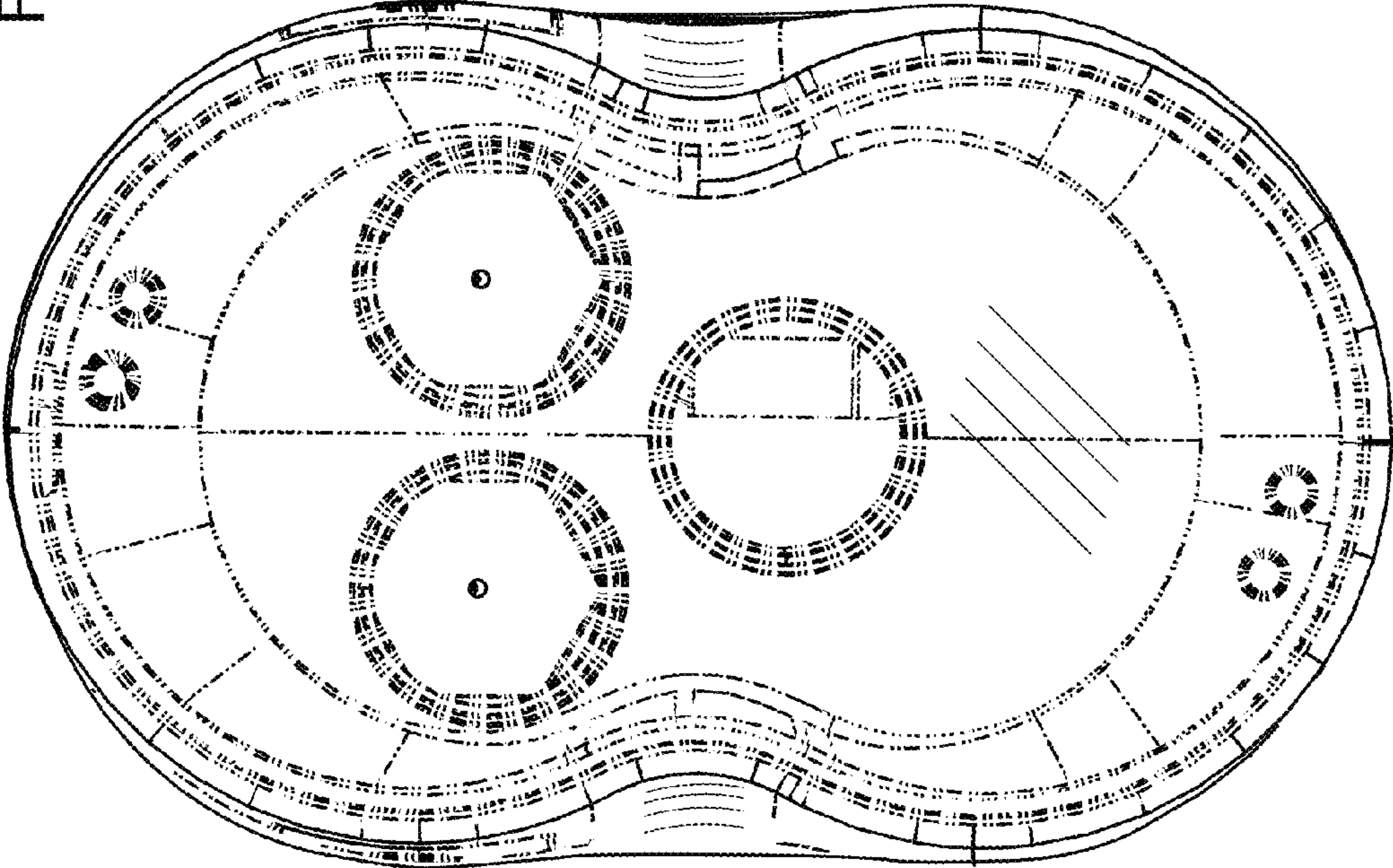

FIGURE 7B

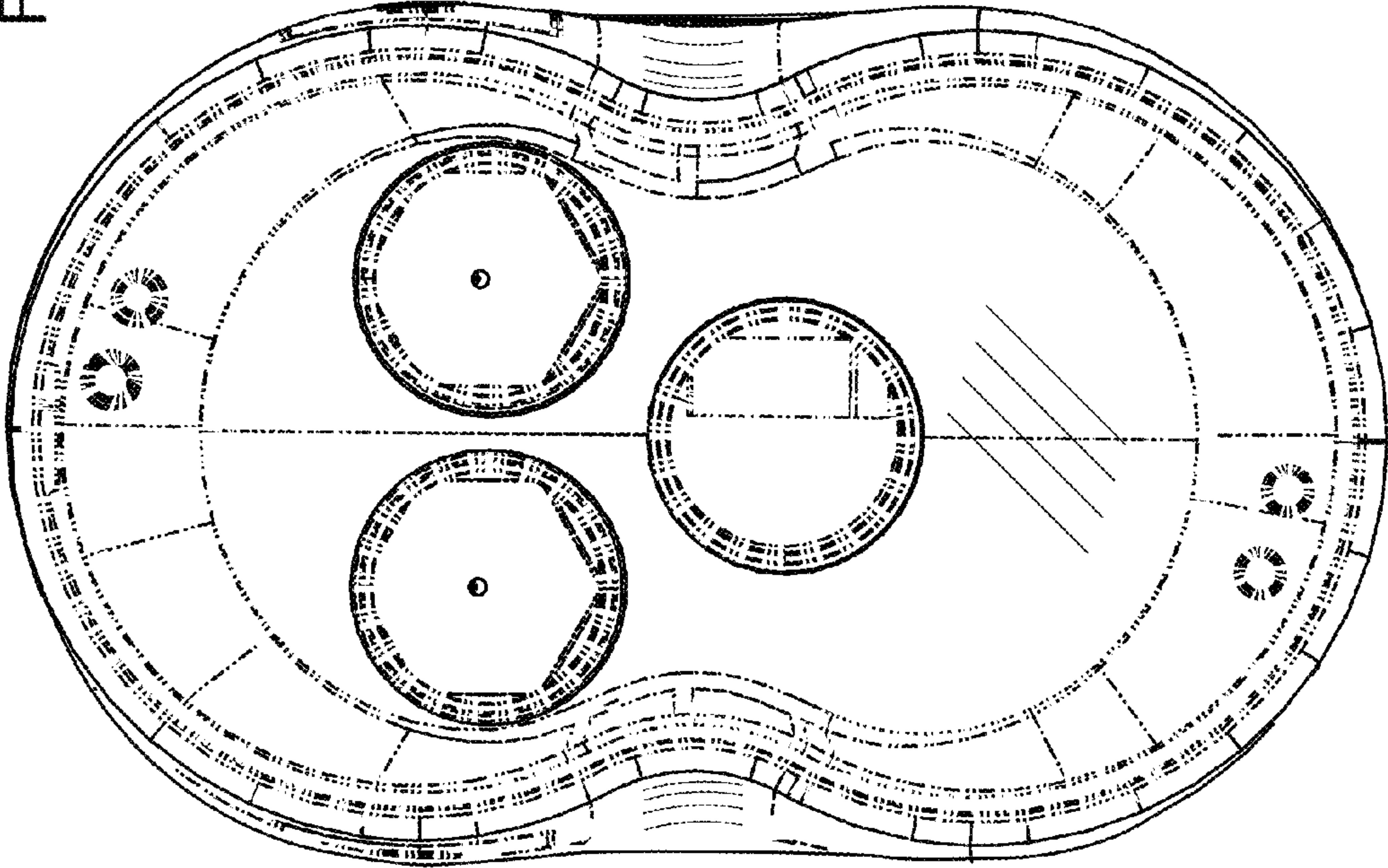

FIGURE 8

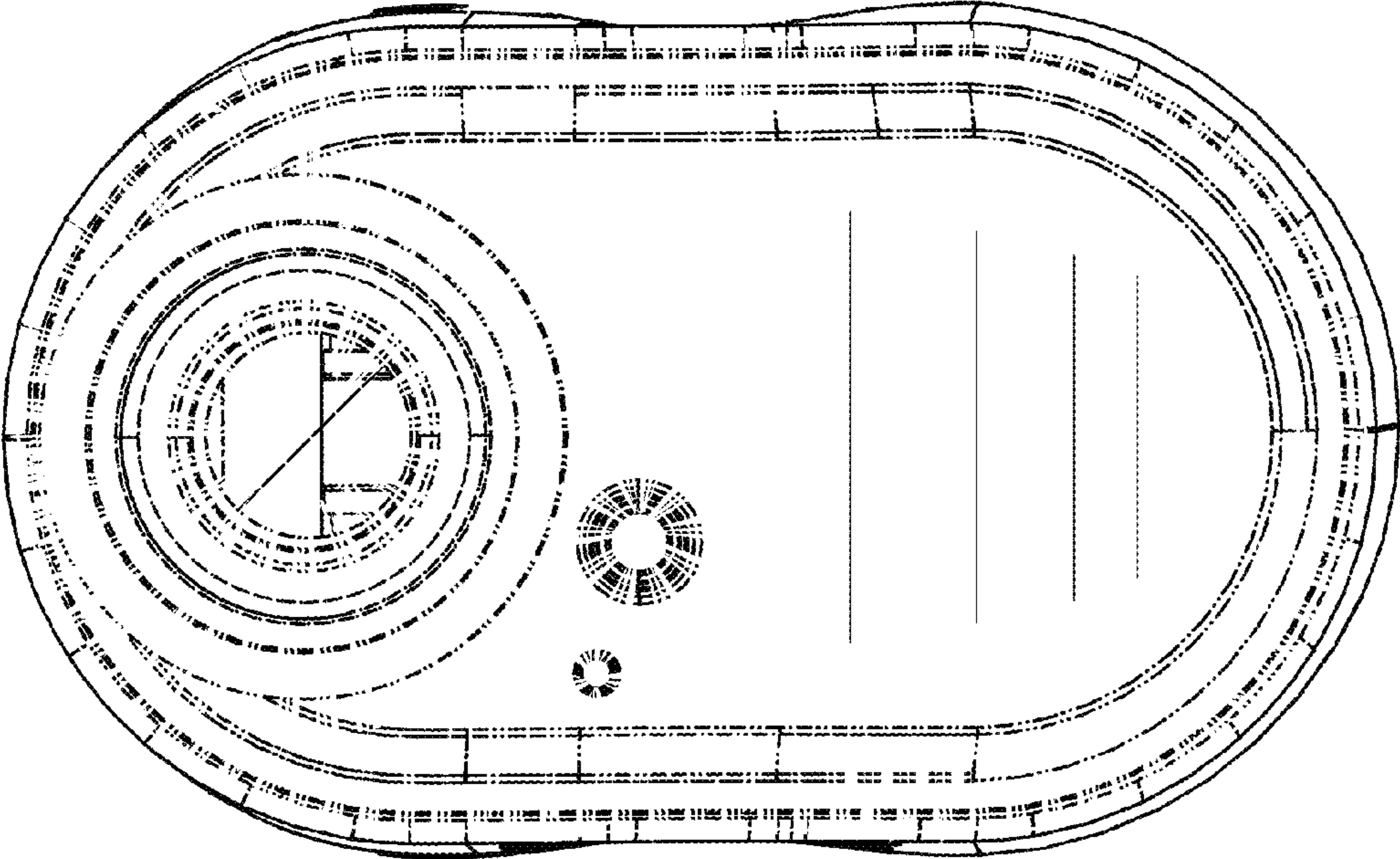

FIGURE 9

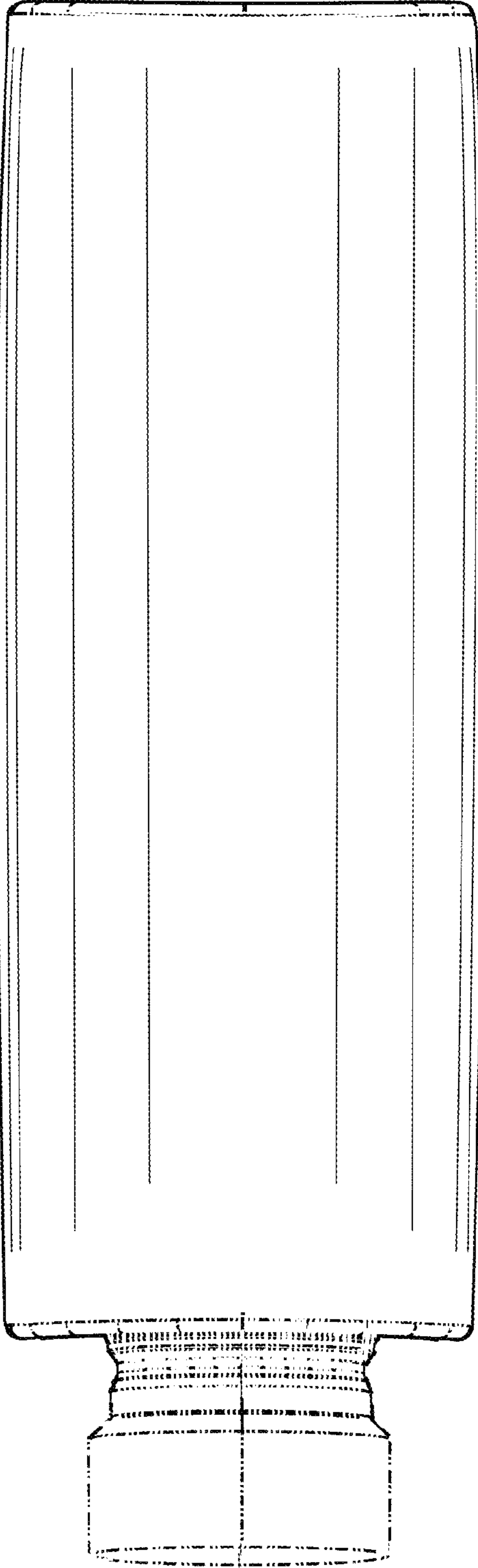

FIGURE 10

