



US00D708741S

(12) **United States Design Patent**  
**Harrison et al.**

(10) **Patent No.:** **US D708,741 S**

(45) **Date of Patent:** **\*\* Jul. 8, 2014**

(54) **HANDLE FOR A MEDICAL DEVICE**

(71) Applicant: **Anchor Orthopedics XT**, Mississauga (CA)

(72) Inventors: **Robert Harrison**, Milton (CA); **Aye Nyein San**, Mississauga (CA); **Ilinca Popovici**, Toronto (CA); **Neil Godara**, Milton (CA); **Jeffery Arnett**, Gilbert, AZ (US); **Dylan Hushka**, Gilbert, AZ (US)

(73) Assignee: **Anchor Orthopedics XT Inc**, Mississauga, Ontario (CA)

(\*) Notice: This patent is subject to a terminal disclaimer.

(\*\*) Term: **14 Years**

(21) Appl. No.: **29/436,661**

(22) Filed: **Nov. 8, 2012**

(51) **LOC (10) Cl.** ..... **24-02**

(52) **U.S. Cl.**  
USPC ..... **D24/133; D24/145**

(58) **Field of Classification Search**  
USPC ..... D24/145, 133, 138, 147; D8/303;  
289/17; 606/1, 53, 86 A, 90, 139,  
606/143-145, 142, 148, 170, 190-191  
See application file for complete search history.

(56) **References Cited**

U.S. PATENT DOCUMENTS

5,084,058	A *	1/1992	Li	606/148
D353,002	S *	11/1994	Tovey	D24/145
5,403,330	A *	4/1995	Tuason	606/148
5,830,220	A *	11/1998	Wan et al.	606/148
D553,738	S *	10/2007	Simonson	D24/133

D585,547	S *	1/2009	Bisleri	D24/135
2008/0306557	A1 *	12/2008	Altarac et al.	606/86 A
2013/0131648	A1 *	5/2013	Haddad	606/1

\* cited by examiner

*Primary Examiner* — Wan Laymon

(74) *Attorney, Agent, or Firm* — Nip Lifshitz; Glenn Arnold

(57) **CLAIM**

The ornamental design for a handle for a medical device, as shown and described.

**DESCRIPTION**

FIG. 1 is a top, front, left side perspective view of a handle for a medical device, showing our new design, wherein the break lines indicate indeterminate length;

FIG. 2 is a top, rear, right side perspective view of the handle of FIG. 1, wherein the break lines indicate indeterminate length;

FIG. 3 is a left side elevational view of the handle of FIG. 1, wherein the break lines indicate indeterminate length;

FIG. 4 is a right side elevational view of the handle of FIG. 1, wherein the break lines indicate indeterminate length;

FIG. 5 is a top plan view of the handle of FIG. 1, wherein the break lines indicate indeterminate length;

FIG. 6 is a bottom plan view of the handle of FIG. 1, wherein the break lines indicate indeterminate length;

FIG. 7 is a rear elevational view of the handle of FIG. 1;

FIG. 8 is a front elevational view of the handle of FIG. 1; and, FIG. 9 is a top, front, left side perspective view of the handle of FIG. 1, wherein the break lines indicate indeterminate length.

The broken lines immediately adjacent the shaded areas represent the bounds of the claimed design while all other broken lines are directed to environment and are for illustrative purposes only; the broken lines form no part of the claimed design.

**1 Claim, 4 Drawing Sheets**

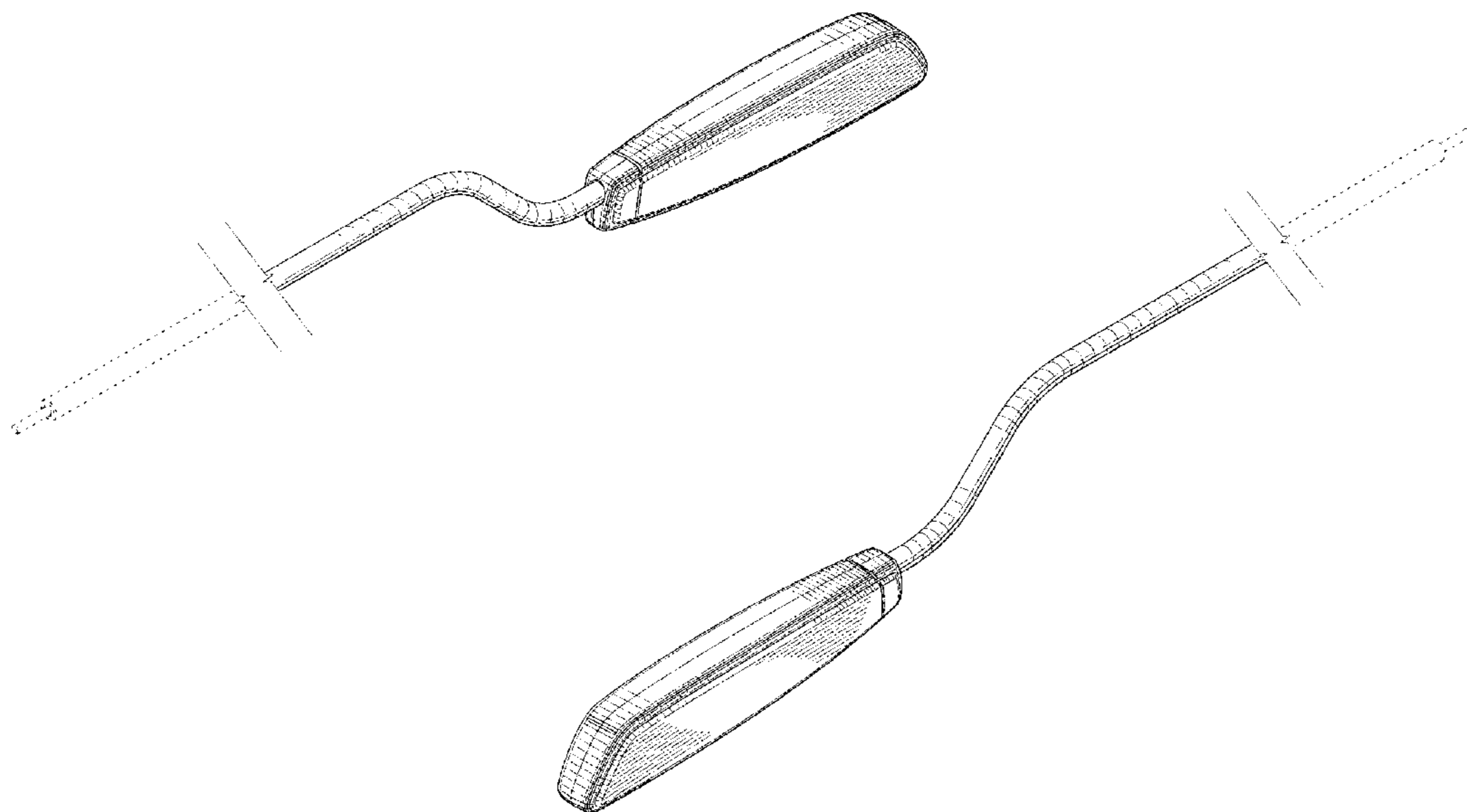

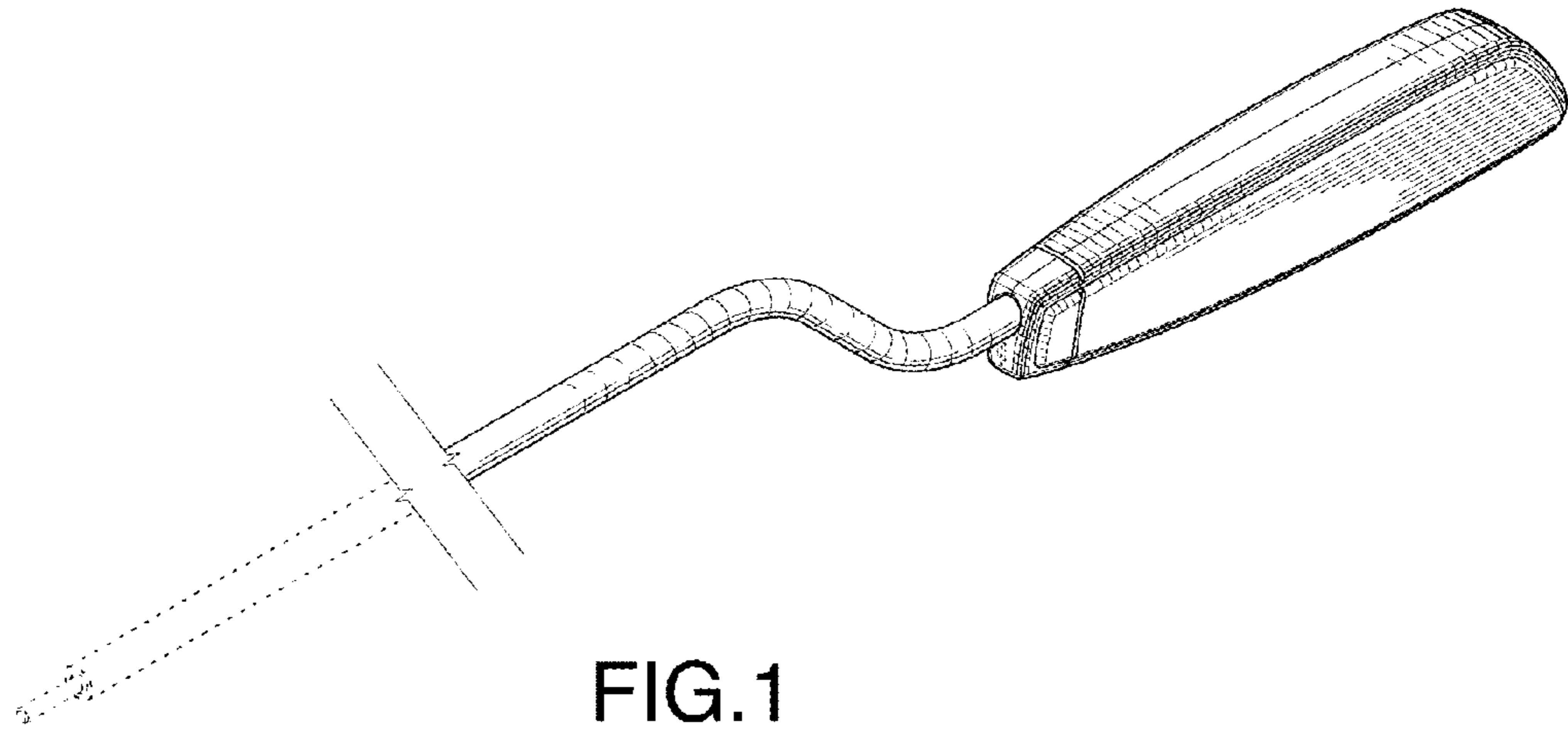

FIG.1

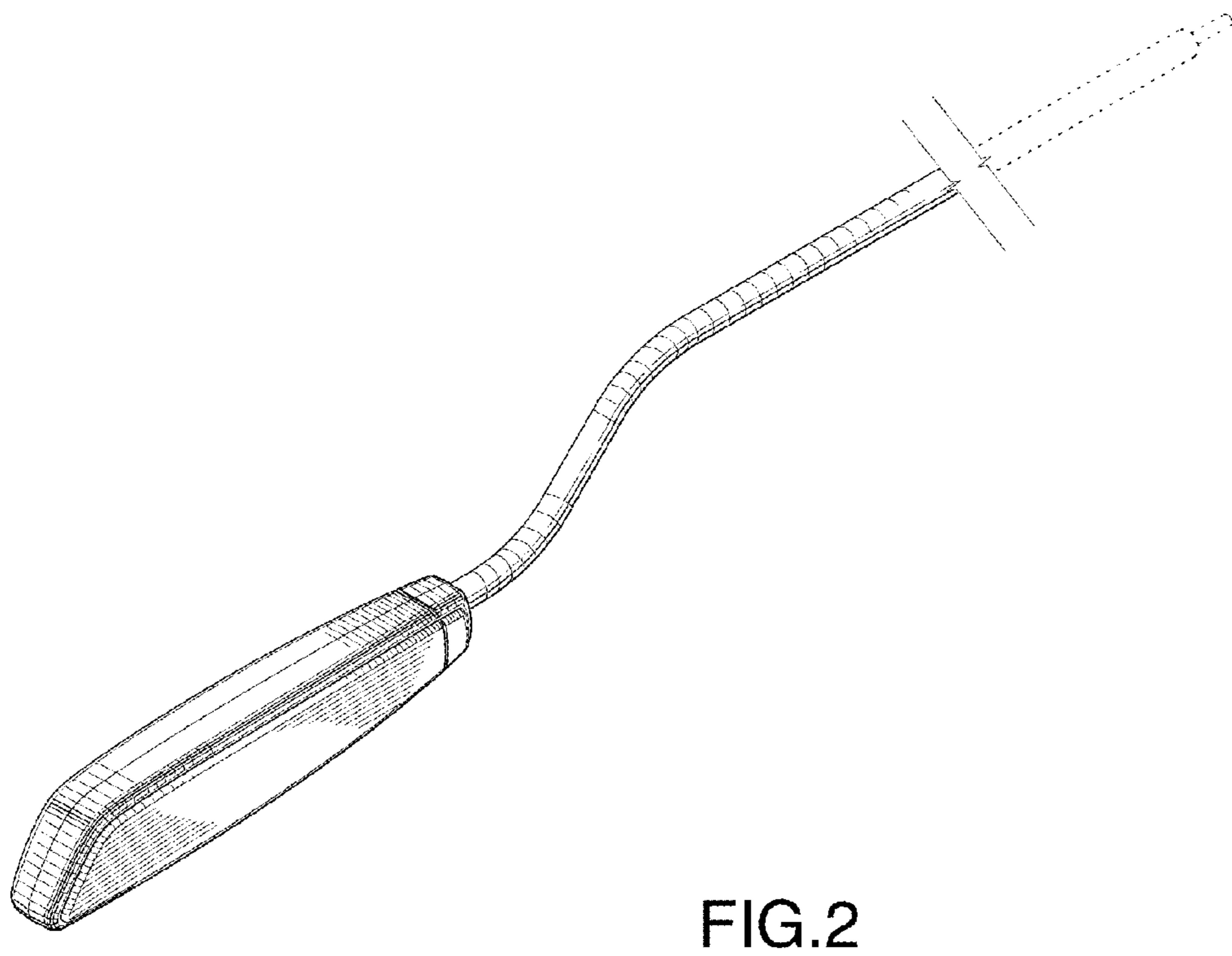

FIG.2

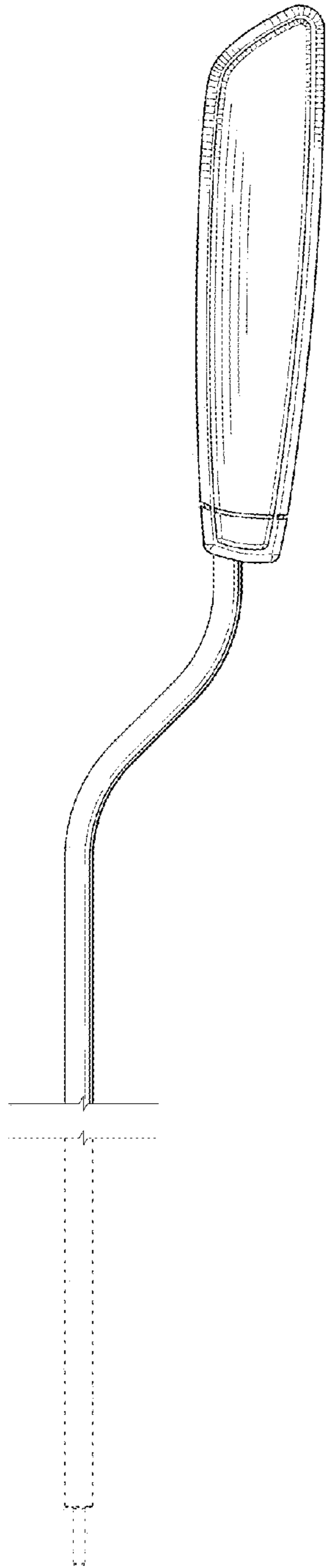

FIG.3

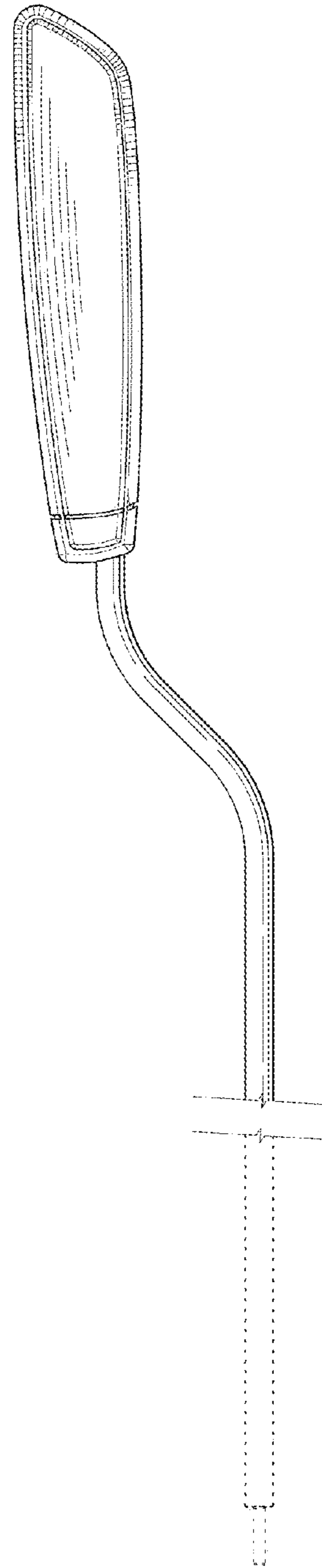

FIG.4

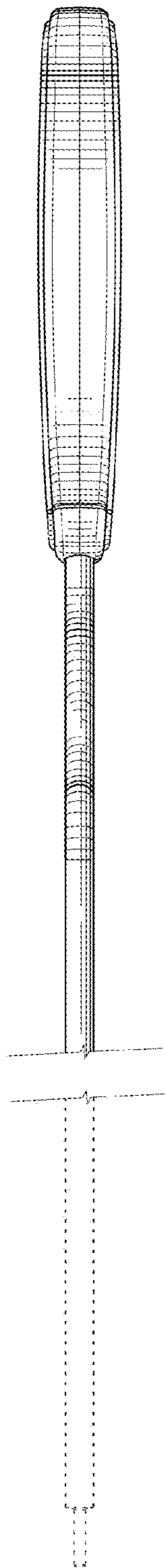

FIG. 5

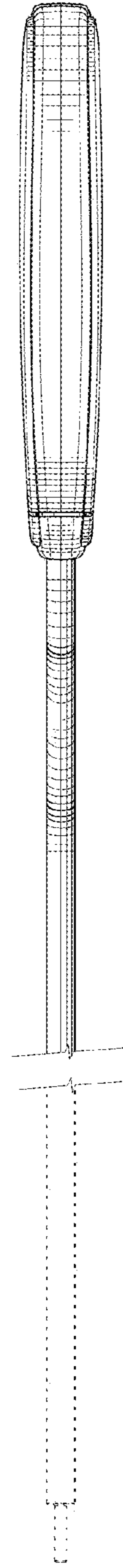

FIG. 6

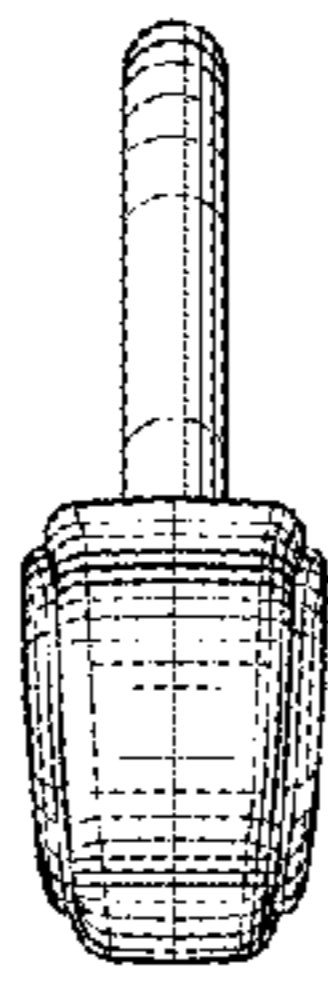

FIG. 7

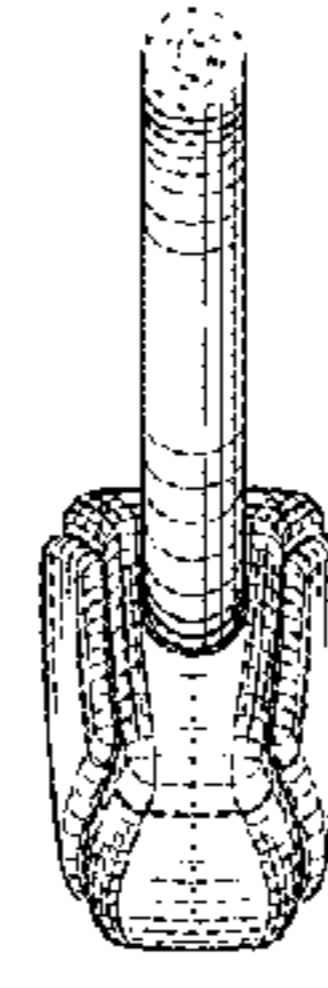

FIG. 8

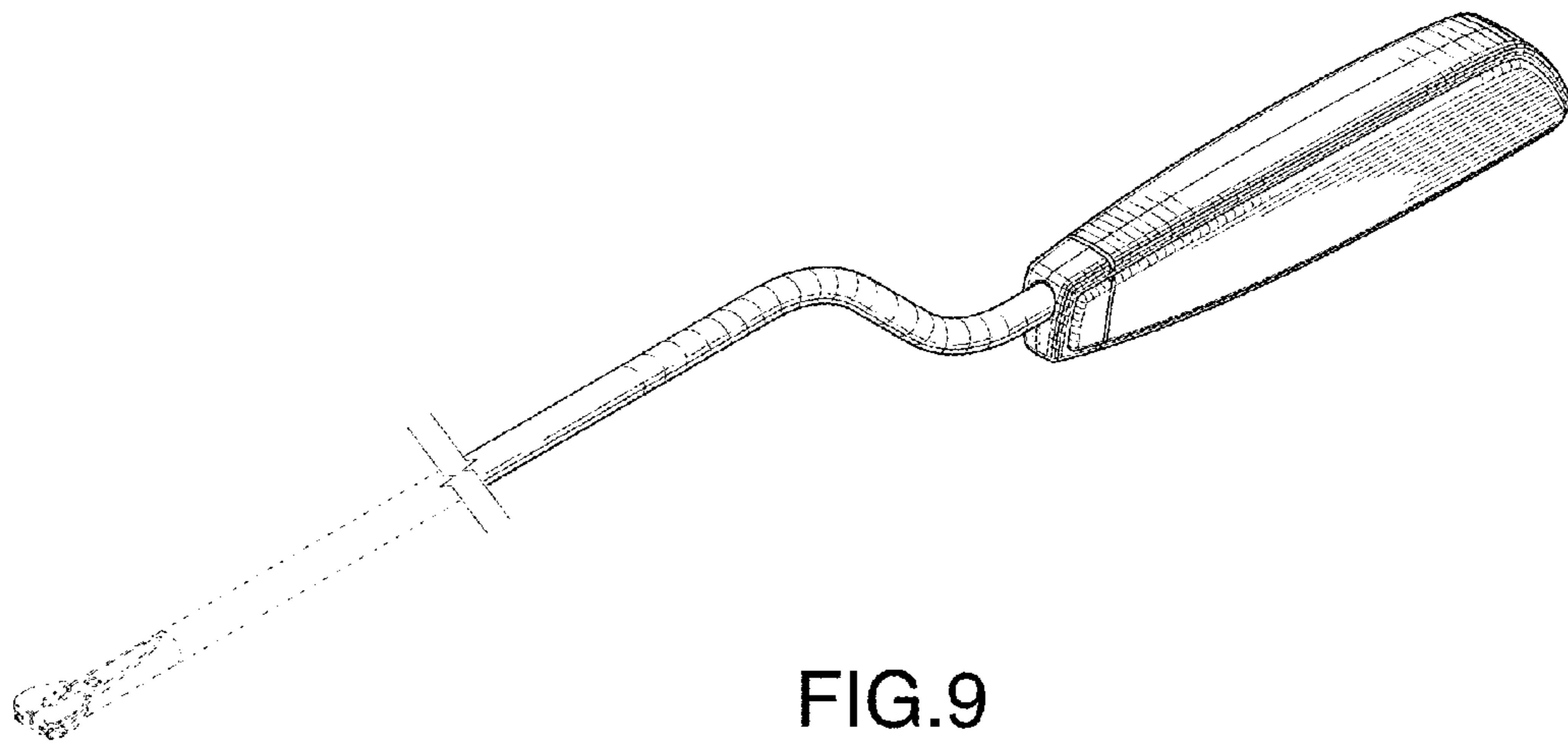

FIG. 9