



US00D708737S

(12) **United States Design Patent**
Sherman et al.

(10) **Patent No.:** **US D708,737 S**
(45) **Date of Patent:** **** Jul. 8, 2014**

(54) **BIOMATERIAL DISPENSING DEVICE**

4,356,941 A 11/1982 McRoskey et al.
4,492,576 A * 1/1985 Dragan 433/90
4,515,586 A 5/1985 Mendenhall et al.

(71) Applicant: **Medtronic Xomed, Inc.**, Jacksonville,
FL (US)

(Continued)

(72) Inventors: **Ethan G. Sherman**, Jacksonville, FL
(US); **Matthew J. Friend**, Jacksonville,
FL (US); **Phillip J. Berman**,
Jacksonville, FL (US)

FOREIGN PATENT DOCUMENTS

CN 201643226 11/2010
EP 0 405 320 A2 1/1991

(Continued)

(73) Assignee: **Medtronic Xomed, Inc.**, Jacksonville,
FL (US)

OTHER PUBLICATIONS

Arista® Absorbable Hemostatic Particles AH Product Information
Sheets, Medafor Hemostatic Polymer Technologies, 3 pages down-
loaded from <http://www.medafor.com/products/arista.aspx> on May
2, 2012.

(Continued)

(**) Term: **14 Years**

Primary Examiner — David Muller

(21) Appl. No.: **29/447,060**

(74) *Attorney, Agent, or Firm* — IPLM Group, P.A.

(22) Filed: **Feb. 28, 2013**

(51) **LOC (10) Cl.** **24-02**

(52) **U.S. Cl.**
USPC **D24/112**

(58) **Field of Classification Search**
USPC D24/112–114, 130, 127, 133, 186, 108;
606/92, 93, 181, 185; 604/218, 264,
604/272, 115, 164.01–164.09, 533, 232,
604/187, 168.01, 192, 19, 48, 93.01, 523,
604/524, 526; 600/101, 139, 143;
128/200.24, 207.14, 207.15; 433/80,
433/89, 90

See application file for complete search history.

(57) **CLAIM**

The ornamental design for a biomaterial dispensing device, as
shown and described.

DESCRIPTION

FIG. 1 is a top perspective view of a biomaterial dispensing
device showing our new design;
FIG. 2 is a left side view thereof;
FIG. 3 is a right side view thereof;
FIG. 4 is a top plan view thereof;
FIG. 5 is a bottom plan view thereof;
FIG. 6 is a front view thereof; and,
FIG. 7 is a back view thereof.

The shade lines in the Figures show contour and not surface
ornamentation.

The broken lines in the Figures show portions of the bioma-
terial dispensing device which form no part of the claimed
design.

(56) **References Cited**

U.S. PATENT DOCUMENTS

1,642,950 A 9/1927 Haas
2,151,418 A 3/1939 Bolte
2,664,891 A 1/1954 Kempel
2,672,144 A 3/1954 Cohen
2,754,590 A 7/1956 Cohen
3,816,921 A * 6/1974 Malmin 433/90
4,015,753 A 4/1977 Bennett
4,261,488 A 4/1981 Bennett
4,307,823 A 12/1981 Heiss et al.

1 Claim, 3 Drawing Sheets

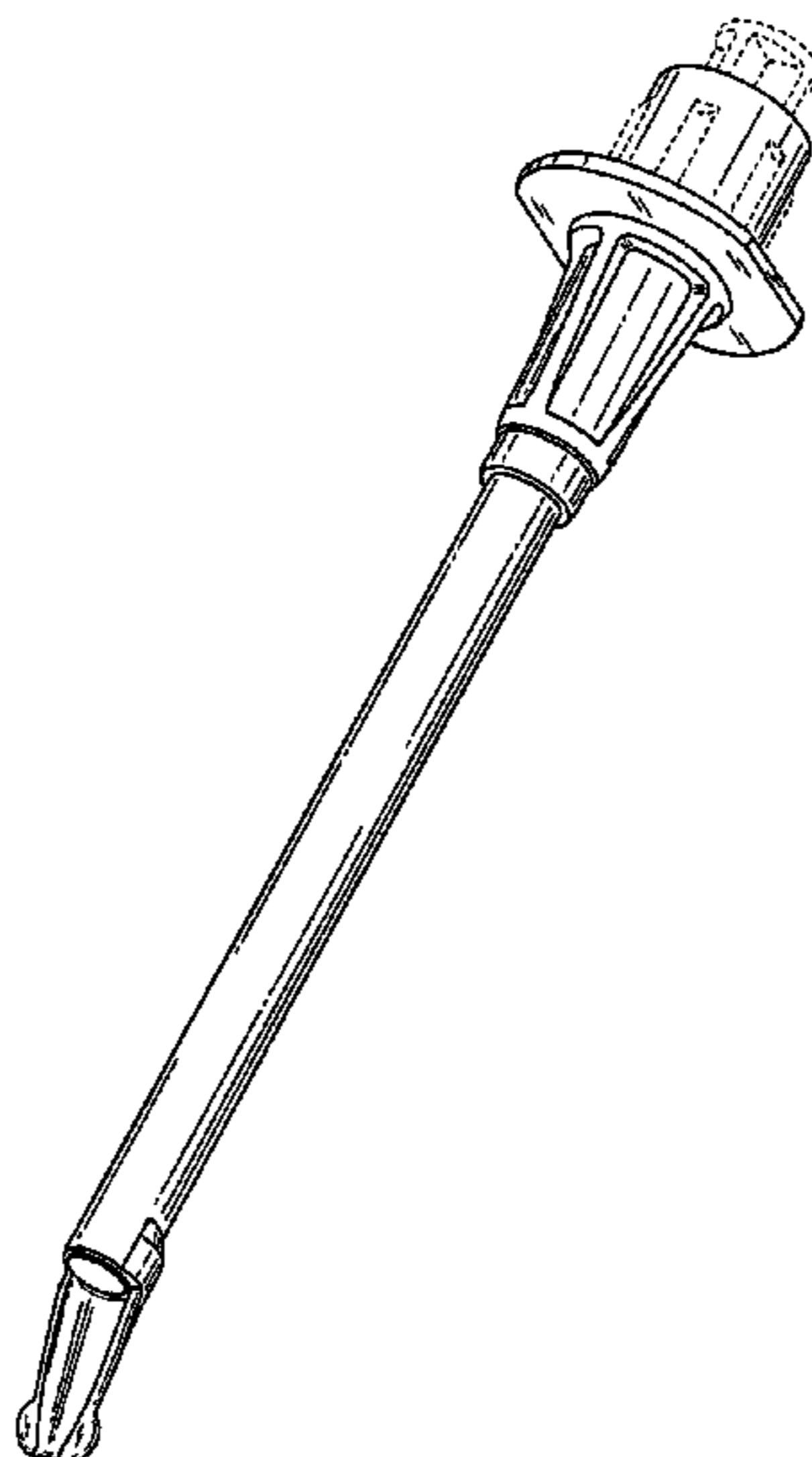

(56)

References Cited

U.S. PATENT DOCUMENTS

4,769,011 A 9/1988 Swaniger
 4,776,704 A 10/1988 Kopunek et al.
 4,801,008 A 1/1989 Rich
 4,801,263 A 1/1989 Clark
 4,963,093 A 10/1990 Dragan
 4,973,246 A * 11/1990 Black et al. 433/80
 5,181,918 A 1/1993 Braudhorst et al.
 5,244,388 A 9/1993 Frush
 5,286,257 A * 2/1994 Fischer 604/218
 5,322,440 A 6/1994 Steele
 5,624,406 A * 4/1997 Labouze 604/218
 5,758,967 A 6/1998 King
 5,800,059 A 9/1998 Cooke et al.
 5,816,804 A 10/1998 Fischer
 5,816,805 A * 10/1998 Cheetham 433/90
 6,013,050 A 1/2000 Bellhouse et al.
 6,059,570 A 5/2000 Dragan et al.
 6,099,307 A 8/2000 Discko, Jr.
 6,238,212 B1 5/2001 Khachatoorian et al.
 RE37,760 E 6/2002 Mathison et al.
 6,540,072 B1 * 4/2003 Fischer 604/218
 6,585,511 B2 7/2003 Dragan et al.
 6,682,348 B2 1/2004 Lawter et al.
 6,976,842 B1 12/2005 Miggantz
 7,040,893 B2 5/2006 Fischer
 7,179,085 B2 * 2/2007 Dorsey et al. 433/80
 7,207,967 B1 4/2007 Bellhouse et al.

7,357,789 B2 4/2008 Bills
 7,431,587 B2 * 10/2008 Pond 433/80
 7,547,292 B2 6/2009 Sheldrake et al.
 7,740,479 B2 * 6/2010 Allred et al. 433/90
 7,834,065 B2 11/2010 Nakajima et al.
 8,066,510 B2 * 11/2011 Ho et al. 433/90
 D685,466 S * 7/2013 Moshinsky D24/130
 8,622,997 B2 * 1/2014 Shippert 604/218
 2002/0119417 A1 8/2002 Ashman
 2005/0155901 A1 7/2005 Krueger et al.
 2008/0281289 A1 11/2008 Lewis

FOREIGN PATENT DOCUMENTS

EP 1 093 767 B1 3/2005
 FR 2 787 717 6/2000
 GB 628675 9/1949
 GB 761588 11/1956
 GB 1127201 9/1968
 GB 357180 9/1981
 JP 10 263421 A 10/1998
 JP 2009-131629 A 6/2009
 WO WO 2004/043533 A2 5/2004

OTHER PUBLICATIONS

DryPette® Hand Held Manual Powder Dispensing System, Product Information Sheets, Zinsser Analytic, 4 pages (2009).

* cited by examiner

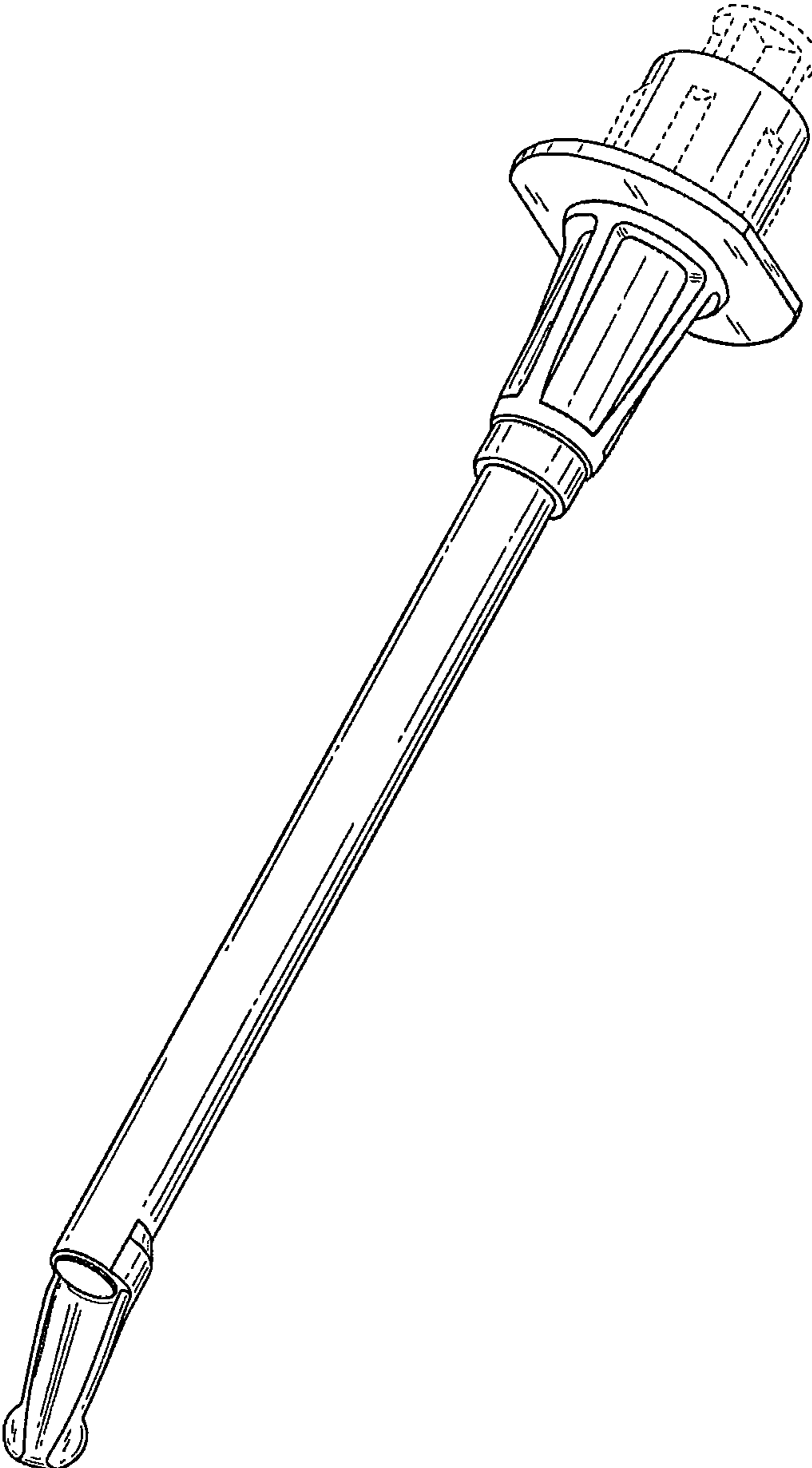

Fig. 1

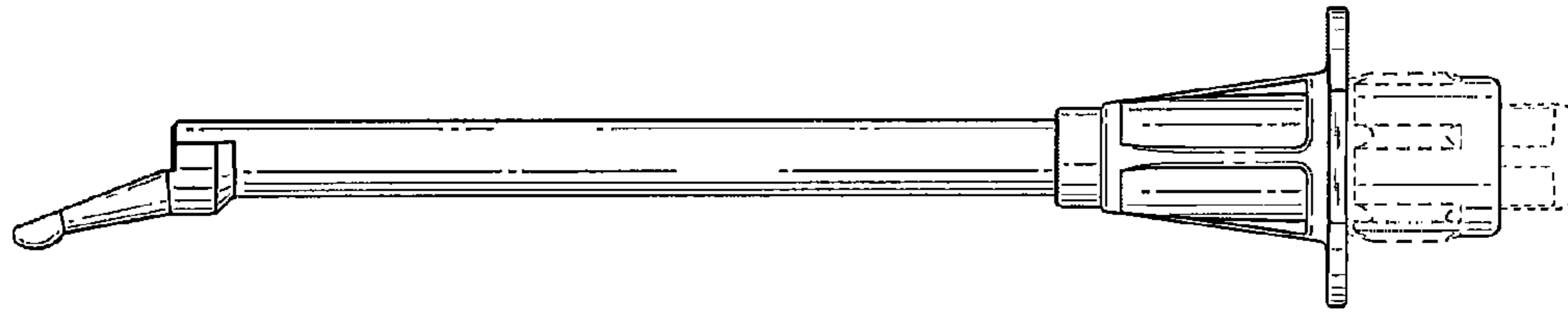

Fig. 2

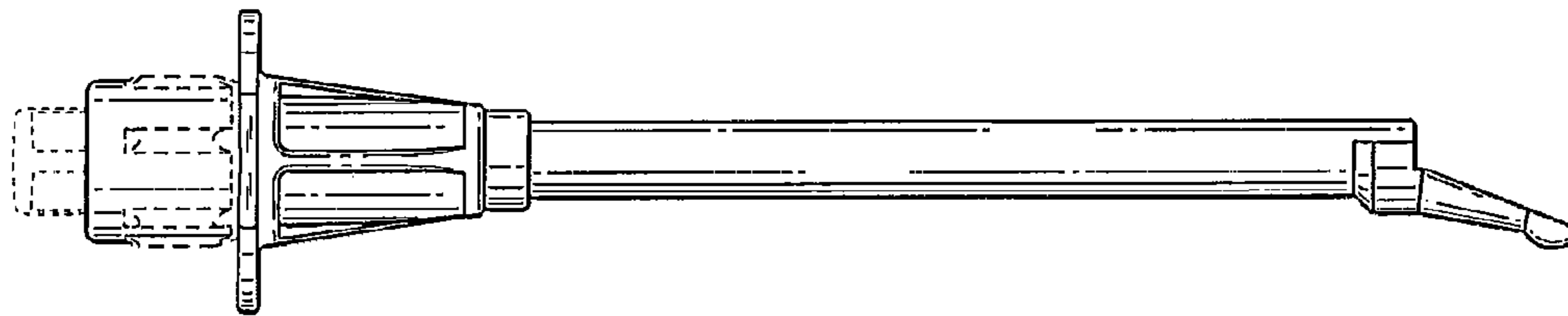

Fig. 3

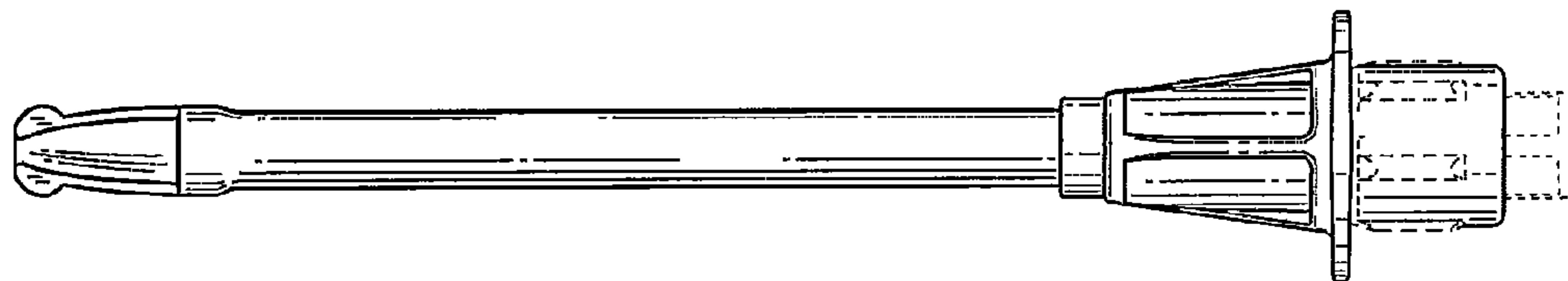

Fig. 4

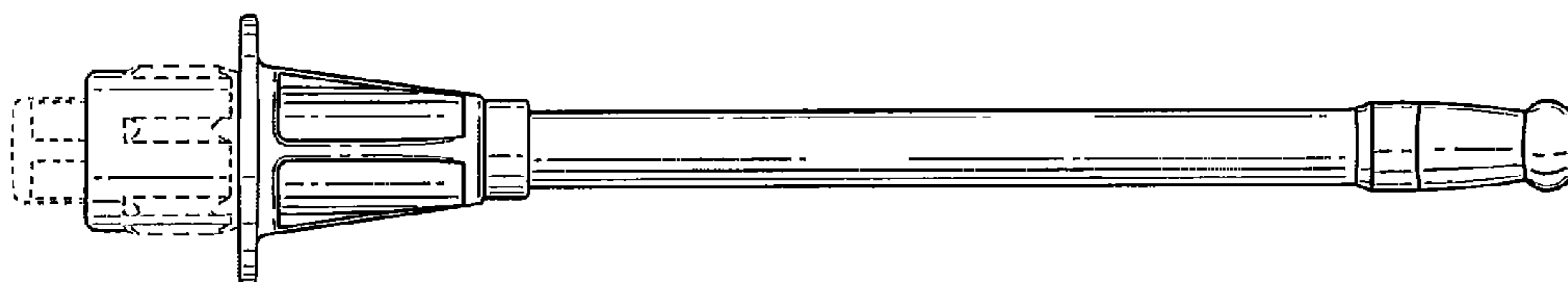

Fig. 5

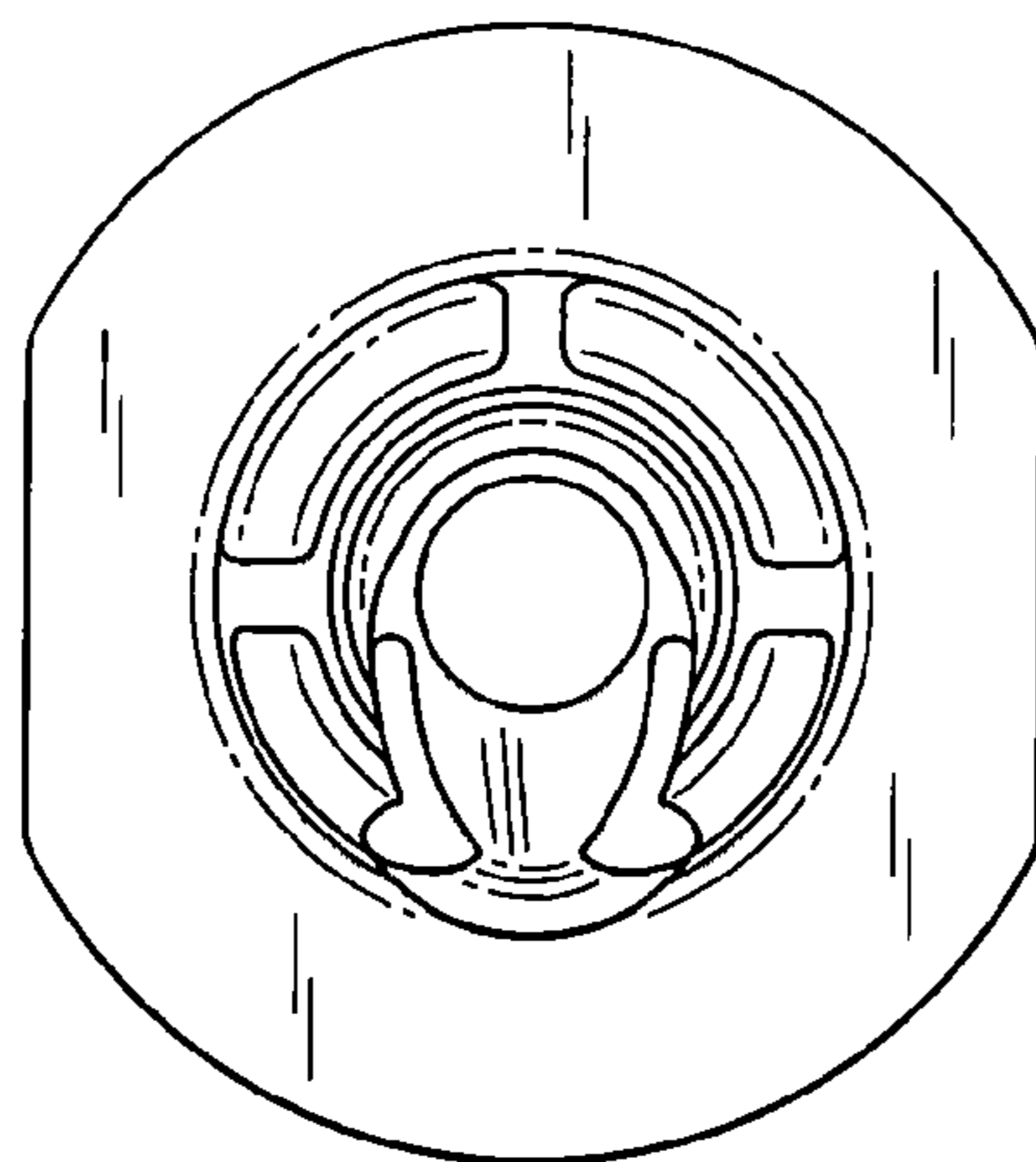

Fig. 6

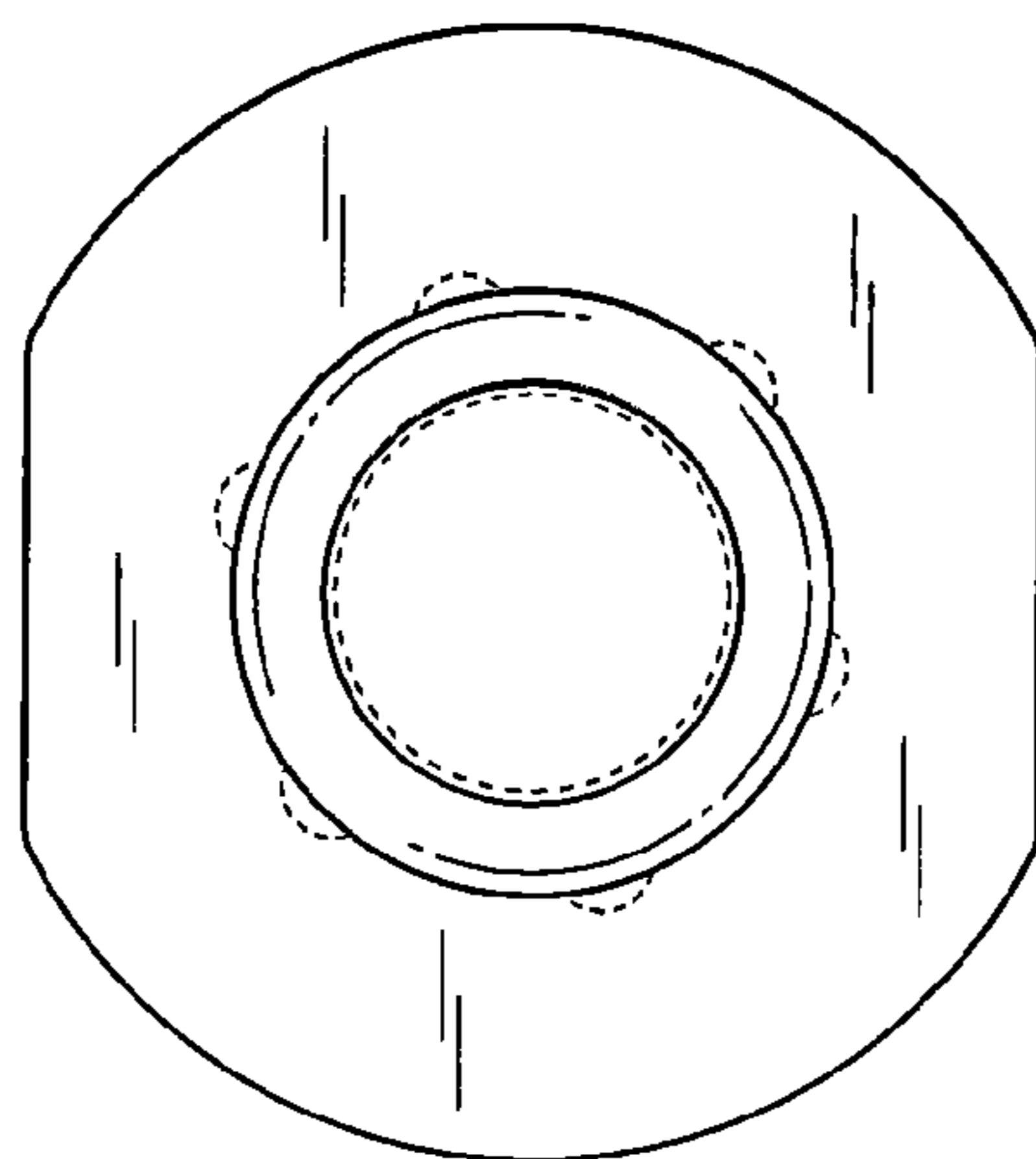

Fig. 7