



US00D708612S

(12) **United States Design Patent**
Oakley

(10) **Patent No.:** **US D708,612 S**

(45) **Date of Patent:** **** Jul. 8, 2014**

(54) **MULTIPLE MODE DISPLAY DEVICE**

(56) **References Cited**

(71) Applicant: **Intel Corporation**, Santa Clara, CA
(US)

U.S. PATENT DOCUMENTS

(72) Inventor: **Nicholas W. Oakley**, Portland, OR (US)

4,778,260	A	10/1988	Okada et al.
4,824,212	A	4/1989	Taniguchi
4,839,837	A	6/1989	Chang
4,903,222	A	2/1990	Carter et al.
5,016,849	A	5/1991	Wu
5,049,862	A	9/1991	Dao et al.
5,196,993	A	3/1993	Herron et al.
5,278,779	A	1/1994	Conway et al.
5,283,862	A	2/1994	Lund

(73) Assignee: **Intel Corporation**, Santa Clara, CA
(US)

(*) Notice: This patent is subject to a terminal disclaimer.

(Continued)

(**) Term: **14 Years**

FOREIGN PATENT DOCUMENTS

(21) Appl. No.: **29/441,009**

JP	02-105194	A	4/1990
JP	08-160387	A	6/1996

(22) Filed: **Dec. 29, 2012**

OTHER PUBLICATIONS

Final Office Action received for U.S. Appl. No. 10/185,154, mailed on May 17, 2005, 17 pages.

Related U.S. Application Data

(Continued)

(63) Continuation of application No. 13/094,068, filed on Apr. 26, 2011, which is a continuation of application No. 11/588,070, filed on Oct. 24, 2006, now Pat. No. 7,932,894, which is a continuation of application No. 10/185,154, filed on Jun. 27, 2002, now Pat. No. 7,126,588.

Primary Examiner — Freda S Nunn

(74) *Attorney, Agent, or Firm* — Patent Capital Group

(51) **LOC (10) Cl.** **14-02**

(57) **CLAIM**

The ornamental design for a multiple mode display device, as shown and described.

(52) **U.S. Cl.**

USPC **D14/371**

DESCRIPTION

(58) **Field of Classification Search**

USPC D14/315-327, 336, 341, 371; D18/1, 2, D18/7, 11; 235/145 A, 145 R; 341/22, 23; 345/104, 156, 168, 169, 173; 361/679.06, 679.08, 679.09, 679.11, 361/679.26, 679.27; 312/223.2

FIG. 1 is a perspective view illustrating a design for a multiple mode display device;
FIG. 2 is a back view thereof;
FIG. 3 is a front view thereof;
FIG. 4 is a side view thereof;
FIG. 5 is another side view thereof;
FIG. 6 is a top view thereof; and,
FIG. 7 is a bottom view thereof.

The broken lines shown in the drawings illustrate portions of the multiple mode display device and form no part of the claimed design.

See application file for complete search history.

1 Claim, 5 Drawing Sheets

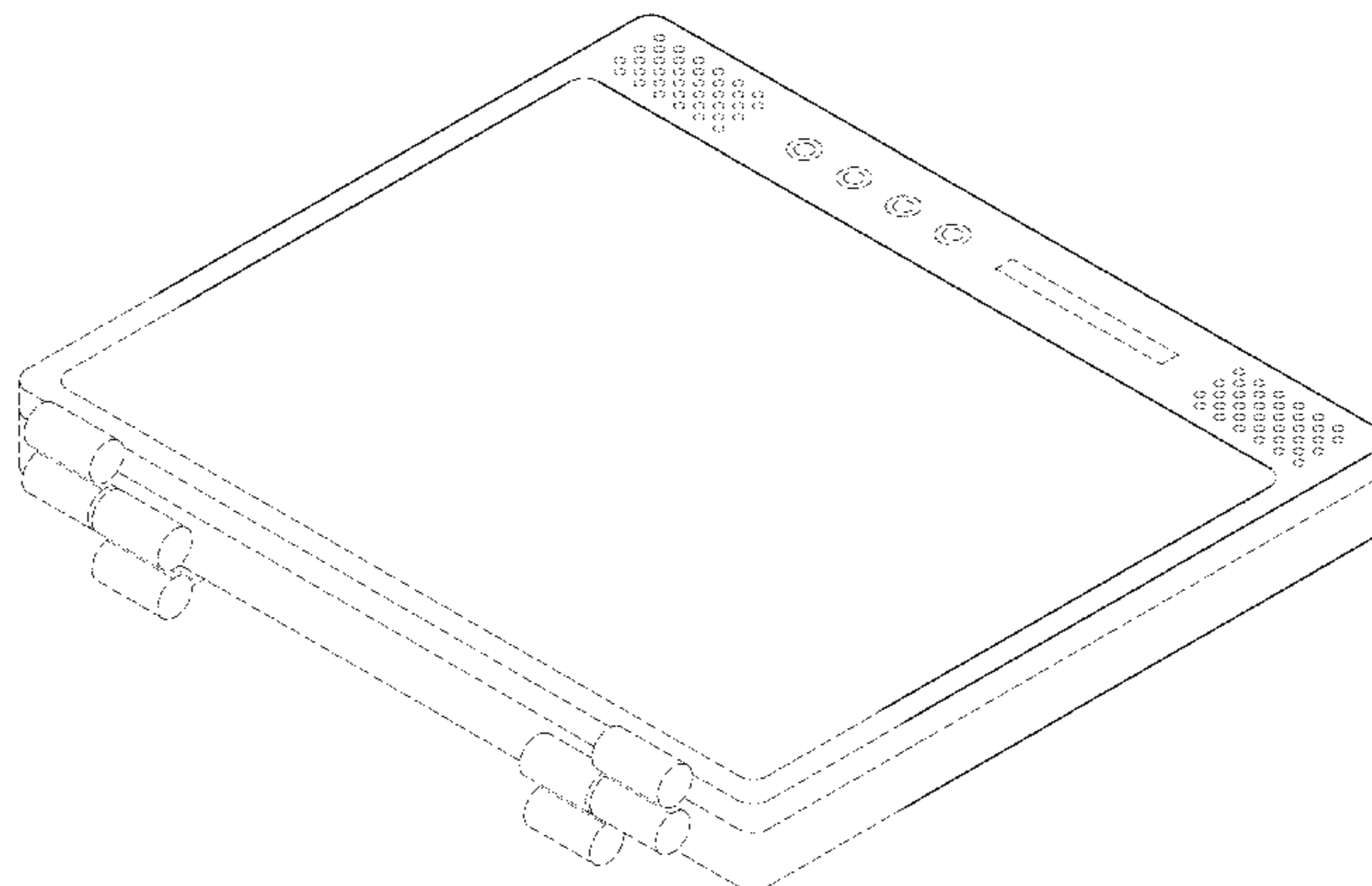

(56)

References Cited

U.S. PATENT DOCUMENTS

5,355,279	A	10/1994	Lee et al.	
5,375,076	A	12/1994	Goodrich et al.	
5,414,444	A	5/1995	Britz	
5,483,250	A	1/1996	Herrick	
5,534,892	A	7/1996	Tagawa	
5,584,054	A	12/1996	Tyneski et al.	
D377,341	S	1/1997	Imai et al.	
5,710,576	A	1/1998	Nishiyama et al.	
5,715,524	A	2/1998	Jambhekar et al.	
5,754,160	A	5/1998	Shimizu et al.	
5,796,577	A	8/1998	Ouchi et al.	
5,805,121	A	9/1998	Burgan et al.	
5,825,341	A	10/1998	Pawlowski	
5,841,431	A	11/1998	Simmers	
5,867,140	A	2/1999	Rader	
5,877,733	A	3/1999	Uchida et al.	
5,881,299	A	3/1999	Nomura et al.	
5,995,085	A	11/1999	Bowen	
6,094,341	A	7/2000	Lin	
6,144,358	A	11/2000	Narayanaswamy et al.	
6,154,359	A	11/2000	Kamikakai et al.	
6,198,624	B1	3/2001	Margaritis	
6,219,681	B1	4/2001	Hawkins et al.	
6,243,258	B1	6/2001	Paratore	
6,256,192	B1	7/2001	Shannon	
6,259,597	B1	7/2001	Anzai et al.	
6,266,241	B1	7/2001	Van Brocklin et al.	
6,292,357	B1	9/2001	Zamora et al.	
6,295,038	B1	9/2001	Rebeske	
D448,764	S	10/2001	Marsalka et al.	
6,341,061	B1	1/2002	Eisbach et al.	
6,661,404	B1	12/2003	Sirola et al.	
6,847,519	B2	1/2005	Arbisi et al.	
6,865,075	B2	3/2005	Oakley	
7,036,025	B2	4/2006	Hunter	
7,069,056	B2	6/2006	Iwata et al.	
7,071,917	B2	7/2006	Kori	
7,126,588	B2	10/2006	Oakley	
7,466,306	B2	12/2008	Connor et al.	
7,633,744	B2	12/2009	Kuhn	
7,636,071	B2	12/2009	O’Gorman	
D618,683	S *	6/2010	Wilson et al.	D14/371
D631,043	S *	1/2011	Kell	D14/341
7,932,894	B2	4/2011	Oakley	
D685,781	S *	7/2013	Adams	D14/315
2003/0132928	A1	7/2003	Kori	
2003/0151888	A1	8/2003	Chien et al.	
2004/0212602	A1 *	10/2004	Nako et al.	345/173
2009/0231233	A1 *	9/2009	Liberatore	345/1.3
2011/0199310	A1	8/2011	Oakley	

OTHER PUBLICATIONS

Final Office Action received for U.S. Appl. No. 10/185,154, mailed on Nov. 29, 2005, 8 pages.
 Non Final Office Action received for U.S. Appl. No. 10/185,154, mailed on Apr. 22, 2004, 14 pages.
 Notice of Allowance received for U.S. Appl. No. 10/185,154, mailed on Jun. 14, 2006, 9 pages.
 Notice of Allowance received for U.S. Appl. No. 10/185,154, mailed on Jun. 23, 2006, 7 pages.
 Response to Final Office Action and RCE for U.S. Appl. No. 10/185,154, filed May 30, 2006, 22 pages.
 Response to Final Office Action for U.S. Appl. No. 10/185,154, filed Nov. 25, 2005, 24 pages.

Response to Non Final Office Action for U.S. Appl. No. 10/185,154, filed Oct. 27, 2004, 18 pages.
 Advisory Action received for U.S. Appl. No. 11/588,070, mailed on Jul. 21, 2010, 3 pages.
 Final Office Action received for U.S. Appl. No. 11/588,070, mailed on Mar. 24, 2010, 9 pages.
 Non Final Office Action received for U.S. Appl. No. 11/588,070, mailed on Jul. 17, 2009, 7 pages.
 Non Final Office Action received for U.S. Appl. No. 11/588,070, mailed on Aug. 5, 2010, 7 pages.
 Notice of Allowance received for U.S. Appl. No. 11/588,070, mailed on Dec. 21, 2010, 9 pages.
 Response to Final Office Action for U.S. Appl. No. 11/588,070, filed Jun. 24, 2010, 11 pages.
 Response to Final Office Action, Advisory Action and RCE filed for U.S. Appl. No. 11/588,070, filed Jul. 26, 2010, 14 pages.
 Response to Non Final Office Action for U.S. Appl. No. 11/588,070, filed Dec. 16, 2009, 11 pages.
 Response to Non Final Office Action for U.S. Appl. No. 11/588,070, filed Nov. 2, 2010, 10 pages.
 Advisory Action received for U.S. Appl. No. 13/094,068, mailed on Jul. 7, 2013, 4 pages.
 Final Office Action received for U.S. Appl. No. 13/094,068, mailed on May 23, 2013, 10 pages.
 Non Final Office Action received for U.S. Appl. No. 13/094,068, mailed on Nov. 23, 2012, 12 pages.
 RCE filed for U.S. Appl. No. 13/094,068, filed Jul. 19, 2013, 3 pages.
 Response to Final Office Action received for U.S. Appl. No. 13/094,068, filed Jul. 5, 2013, 13 pages.
 Response to Non Final Office Action received for U.S. Appl. No. 13/094,068, filed Dec. 26, 2012, 10 pages.
 Bowman, D. “Ericsson R380 Smartphone”, GEEK.com PDA Review, Nov. 24, 2000, pp. 1-11, available at: <http://www.geek.com/hwswrev/pda/ericr380/>.
 Greenberg, S. “Designing Computers As Public Artifacts”, Proceedings of Design Computing on the Net (DCNet’99), Nov. 30-Dec. 3, 1999, pp. 1-16.
 Lim, L. “Ericsson R380—The World in Your Hands”, iMobile.com.au (Australian On-Line Mobile Phone Magazine), Sep. 2001, pp. 1-3, available at: <http://www.imobile.com.au/PhoneReviews/default.asp?ID=reviewssep0101>.
 Oakley, Nicholas W., U.S. Appl. No. 29/441,010, filed Dec. 29, 2012, 7 pages.
 Oakley, Nicholas W., U.S. Appl. No. 29/441,011, filed Dec. 29, 2012, 7 pages.
 Oakley, Nicholas W., U.S. Appl. No. 29/441,012, filed Dec. 29, 2012, 8 pages.
 Williams, M., “Sony Unveils Cool new Vaio”, PCWORLD.COM, Jan. 10, 2002, pp. 1-3 (plus three pictures), available at: <http://www.pcworld.com/news/article/0,aid,78983,00.asp>.
 Office Action received for U.S. Appl. No. 13/094,068, mailed on Sep. 11, 2013.
 Office Action received for U.S. Appl. No. 29/441,010, mailed on Nov. 18, 2013.
 Office Action received for U.S. Appl. No. 29/441,011, mailed on Nov. 18, 2013.
 Office action received for U.S. Appl. No. 29/441,012, mailed on Oct. 23, 2013.
 Non-Final Office Action in U.S. Appl. No. 29/441,010 mailed on Mar. 18, 2014.
 Non-Final Office Action in U.S. Appl. No. 29/441,011 mailed on Mar. 17, 2017.
 Notice of Allowance in U.S. Appl. No. 29/441,012 mailed on Feb. 27, 2014.

* cited by examiner

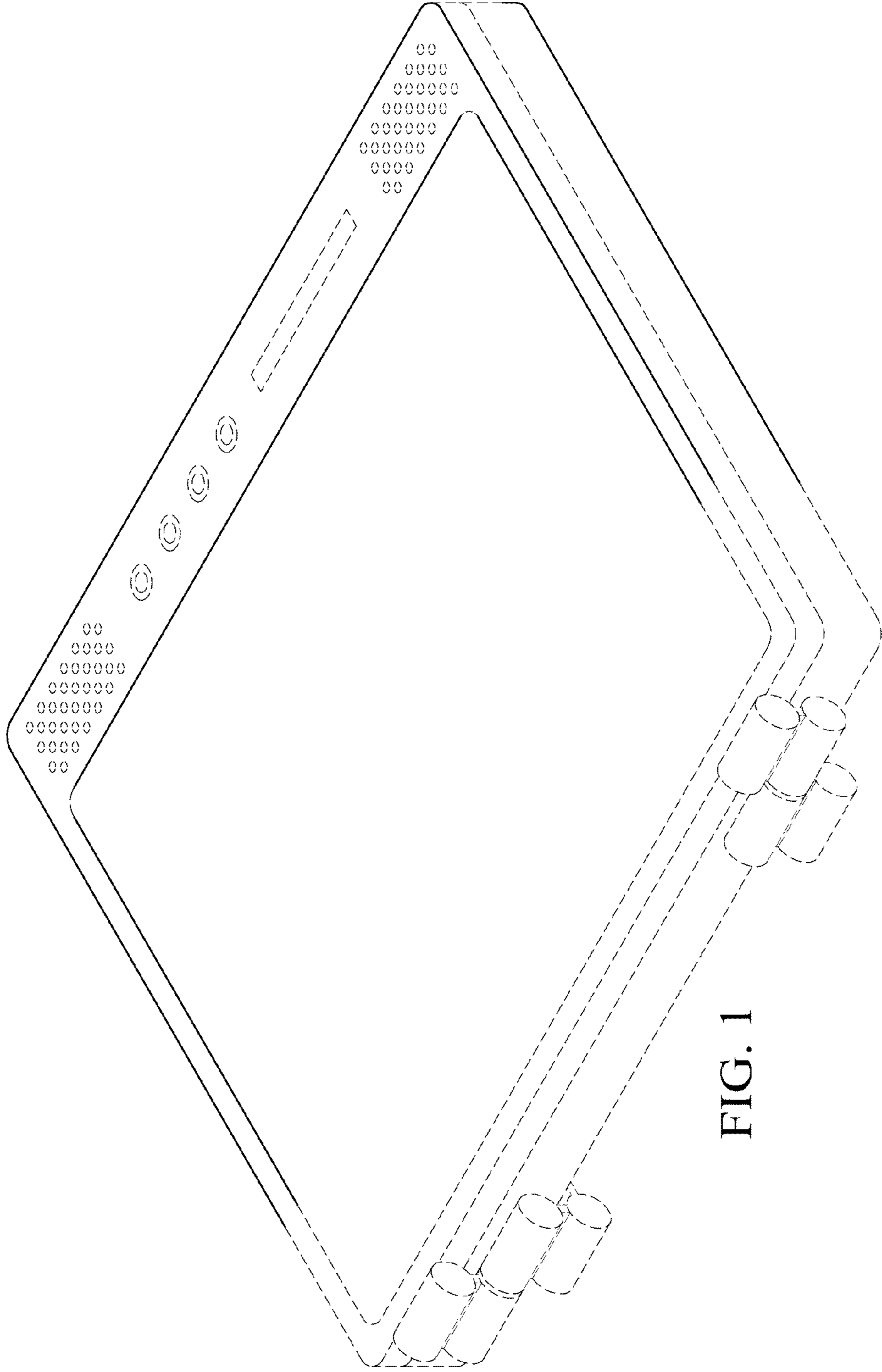

FIG. 1

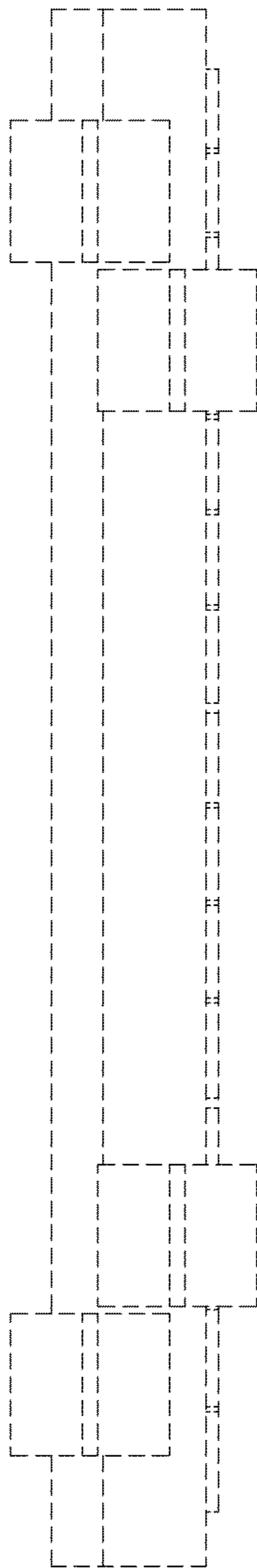

FIG. 2

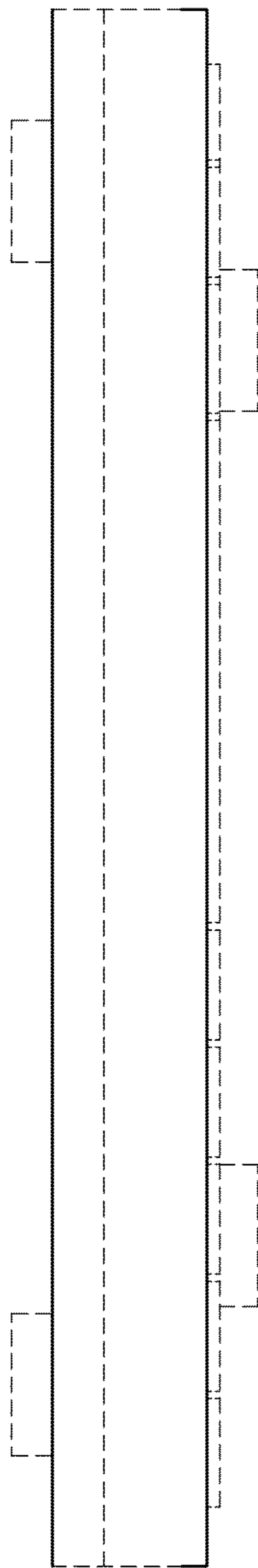

FIG. 3

FIG. 4

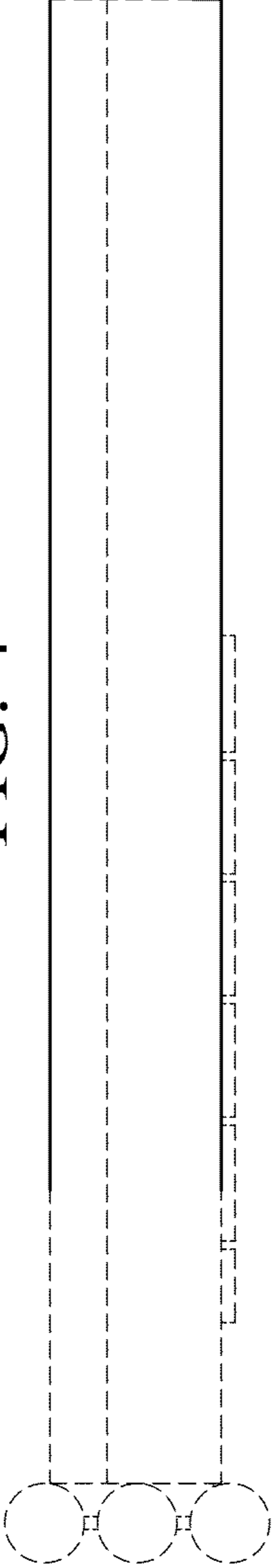

FIG. 5

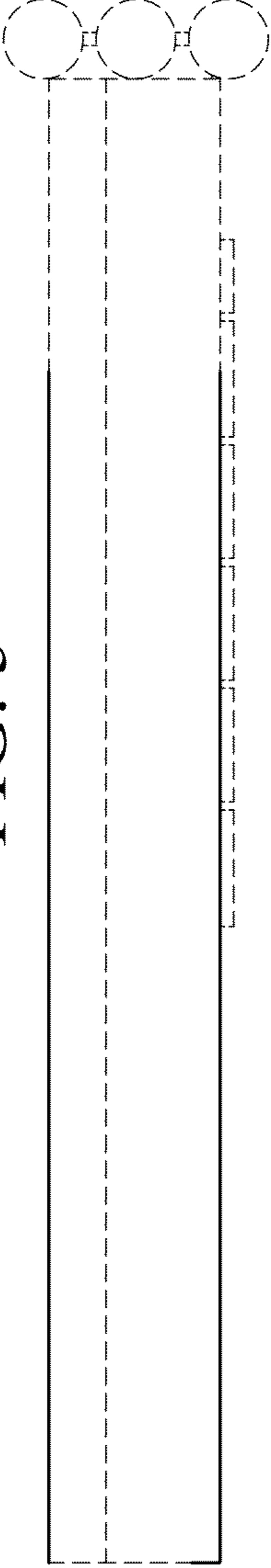
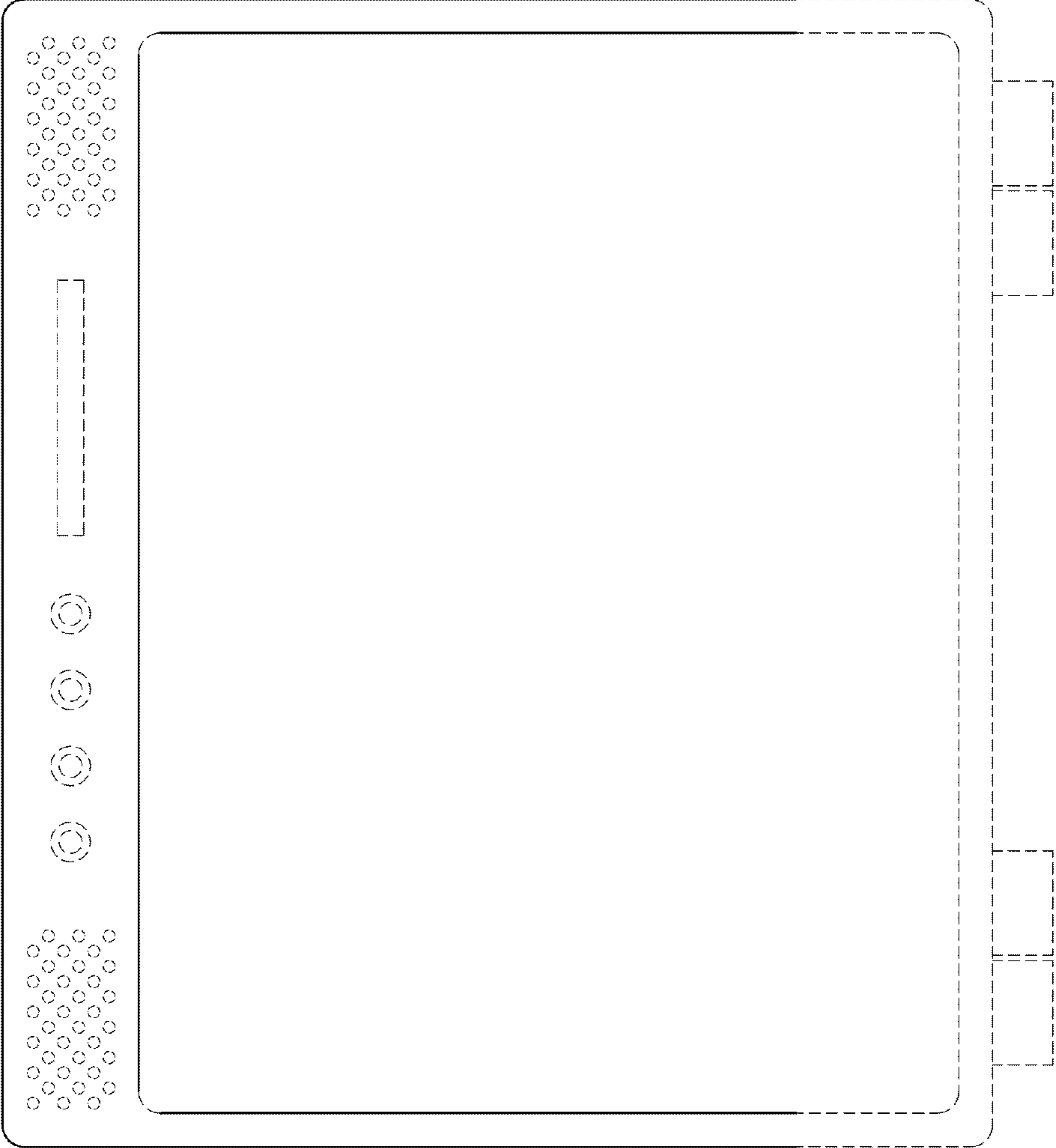

FIG. 6



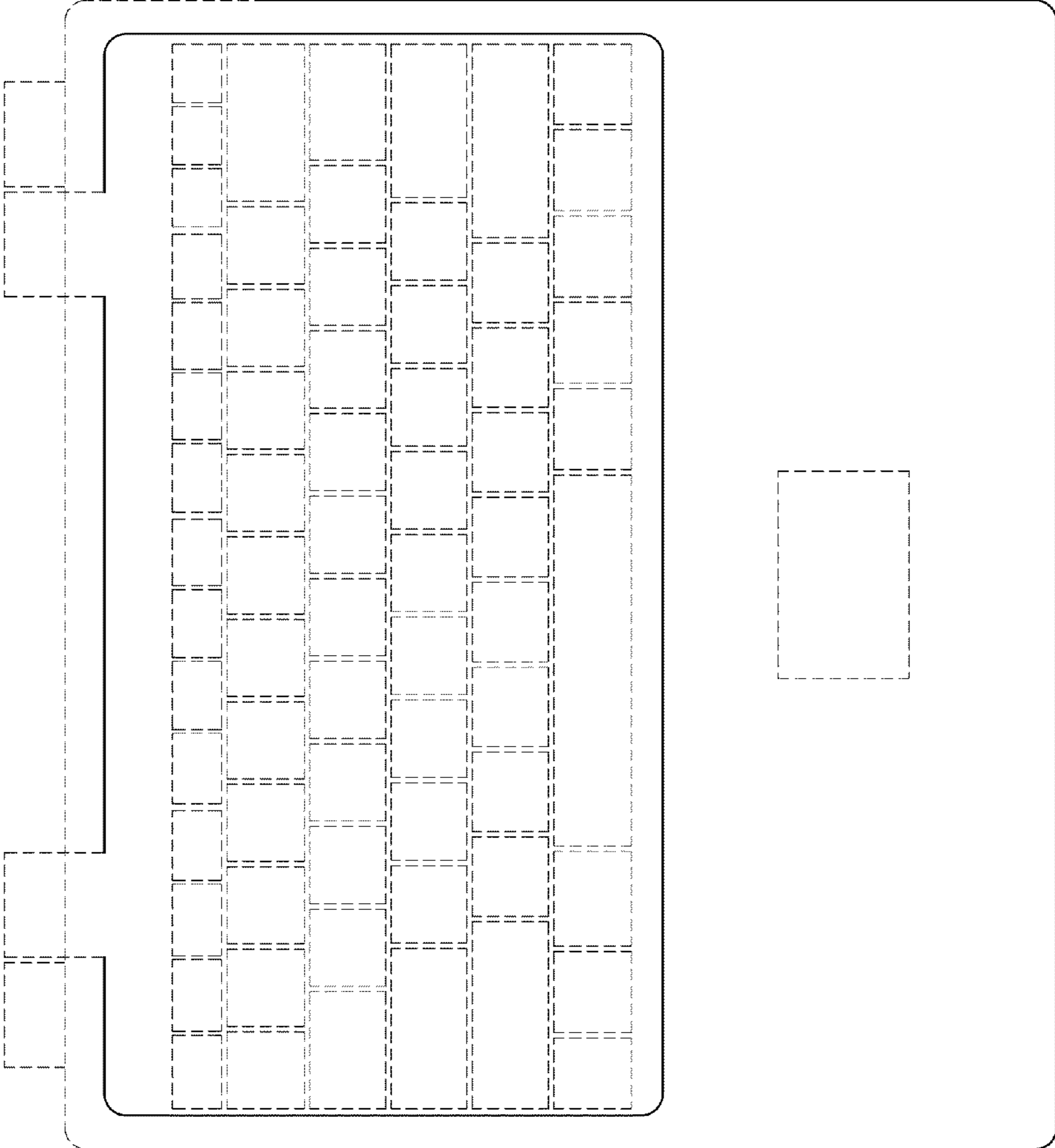

FIG. 7