



US00D708604S

(12) **United States Design Patent**  
**Tanner et al.**

(10) **Patent No.:** **US D708,604 S**  
(45) **Date of Patent:** **\*\* Jul. 8, 2014**

(54) **NOTEBOOK COMPUTER HOUSING**

(71) Applicant: **Google Inc.**, Mountain View, CA (US)

(72) Inventors: **James Tanner**, Los Gatos, CA (US);  
**Lawrence Lam**, San Jose, CA (US)

(73) Assignee: **Google Inc.**, Mountain View, CA (US)

(\*\*) Term: **14 Years**

(21) Appl. No.: **29/436,501**

(22) Filed: **Nov. 6, 2012**

(51) **LOC (10) Cl.** ..... **14-02**

(52) **U.S. Cl.**  
USPC ..... **D14/315**

(58) **Field of Classification Search**  
USPC ..... D14/315-327, 439; D18/1, 2, 7, 11;  
235/145 A, 145 R; 341/22, 23; 345/104,  
345/156, 168, 169, 173; 361/679.08,  
361/679.09, 679.11, 679.26, 679.27;  
16/367

See application file for complete search history.

(56) **References Cited**

**U.S. PATENT DOCUMENTS**

5,566,048	A *	10/1996	Esterberg et al.	.....	361/679.27
D558,752	S *	1/2008	Andre et al.	.....	D14/315
D564,511	S *	3/2008	Akhtar	.....	D14/318
D630,221	S *	1/2011	Sogabe et al.	.....	D14/439
D635,575	S *	4/2011	Masui et al.	.....	D14/439
2002/0080576	A1 *	6/2002	Katagiri	.....	361/686
2002/0089819	A1 *	7/2002	Misawa et al.	.....	361/683

2002/0176224	A1 *	11/2002	Dhar et al.	.....	361/683
2006/0146488	A1 *	7/2006	Kimmel	.....	361/681
2006/0209503	A1 *	9/2006	Bovio et al.	.....	361/681
2006/0282985	A1 *	12/2006	Lu et al.	.....	16/367

\* cited by examiner

*Primary Examiner* — Freda S Nunn

(74) *Attorney, Agent, or Firm* — Lerner, David, Littenberg,  
Krumholz & Mentlik, LLP

(57) **CLAIM**

The ornamental design for a notebook computer housing, as shown and described.

**DESCRIPTION**

FIG. 1 is a rear perspective view of a notebook computer housing according to our new design;  
FIG. 2 is an enlarged detailed view of a section thereof;  
FIG. 3 is a front view thereof;  
FIG. 4 is a back view thereof;  
FIG. 5 is a right side view thereof;  
FIG. 6 is a left side view thereof;  
FIG. 7 is a top view thereof; and,  
FIG. 8 is a bottom view thereof.

Broken lines are environmental only and form no part of the claimed design.

Dash-dot lines adjacent un-shaded areas represent bounds of the claimed design and form no part of the claimed design themselves.

**1 Claim, 4 Drawing Sheets**

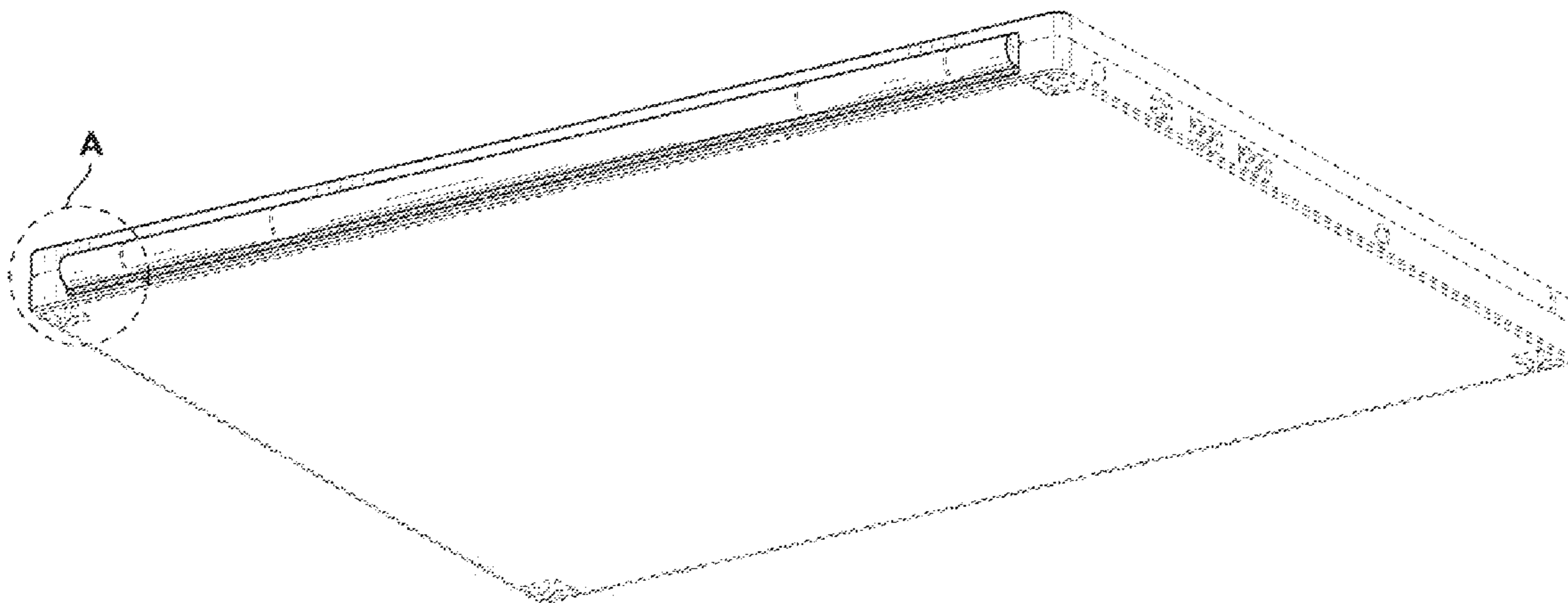

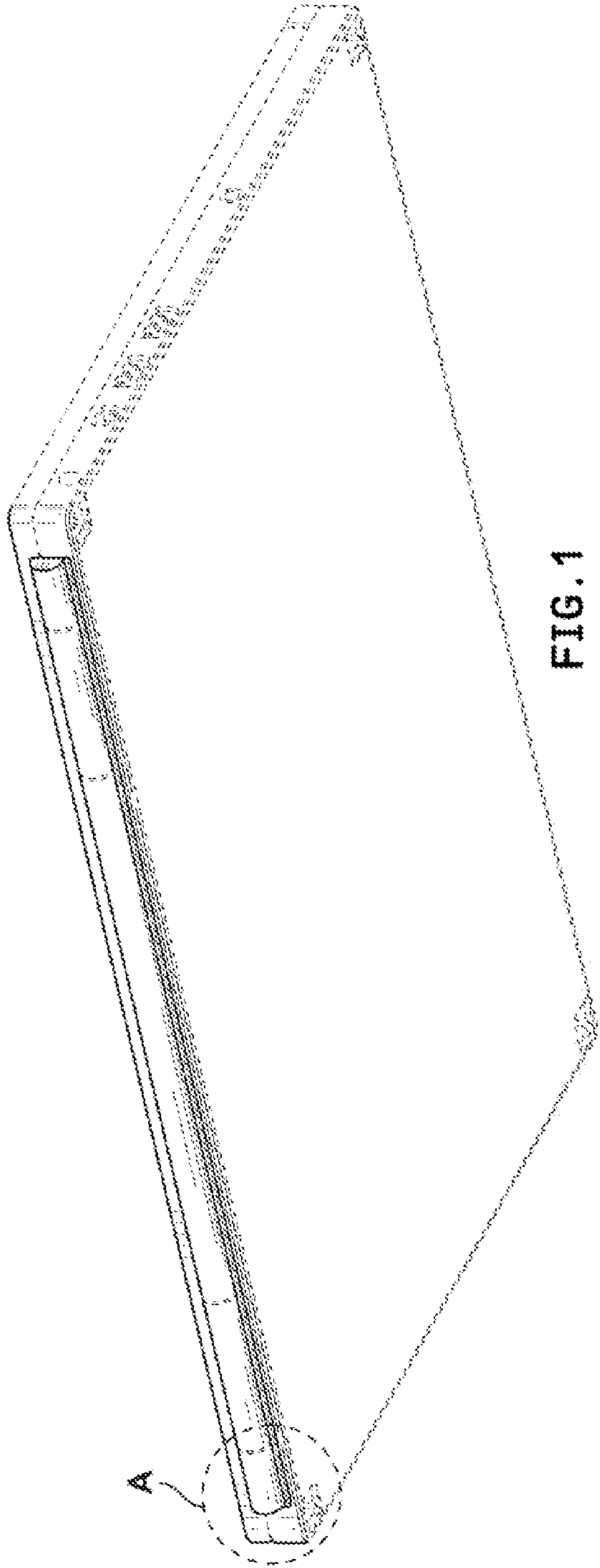

FIG. 1

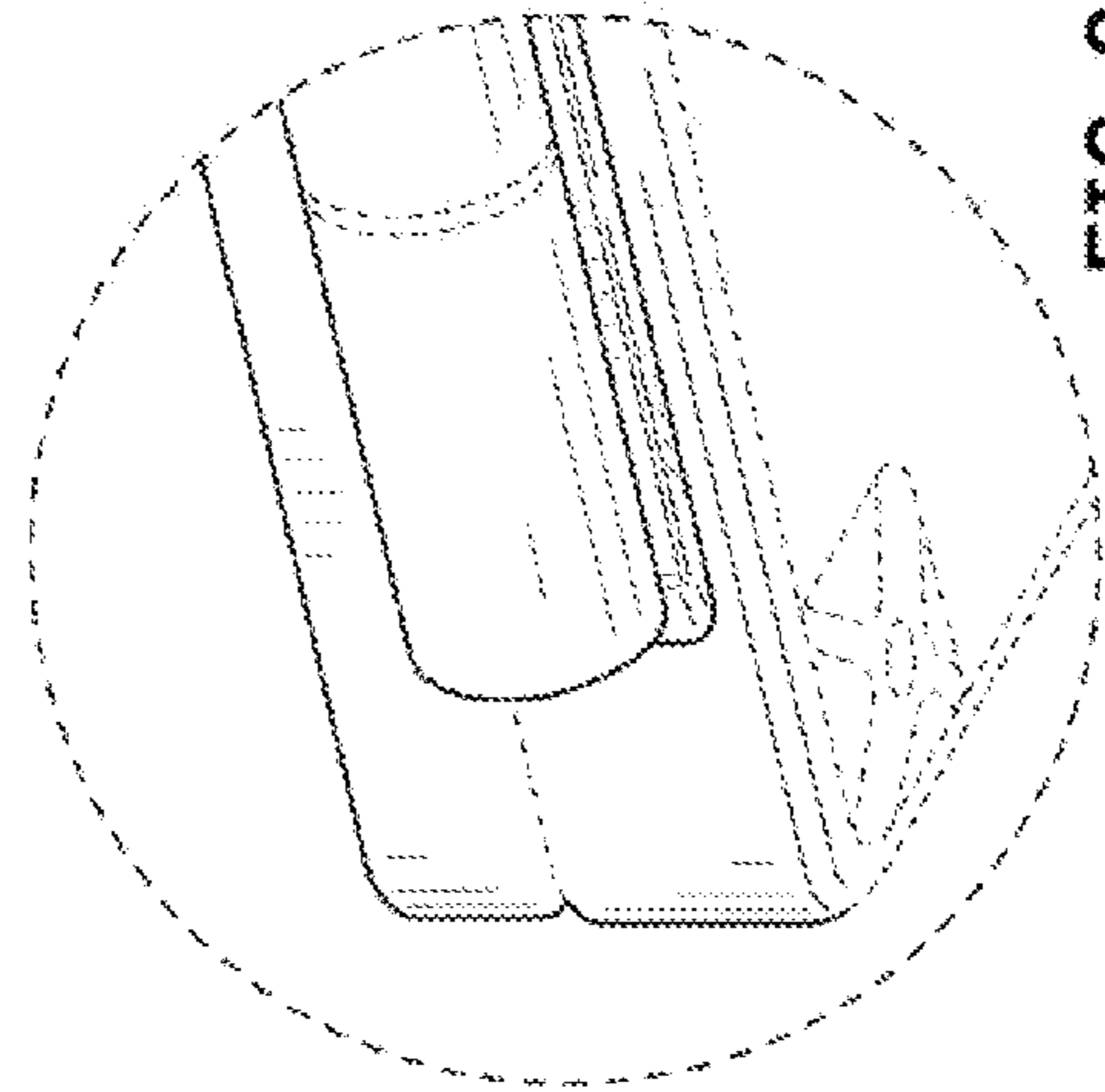

FIG. 2

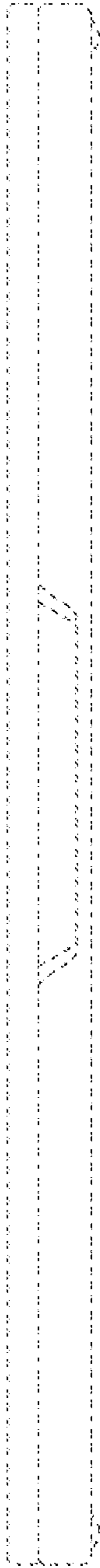

FIG. 3

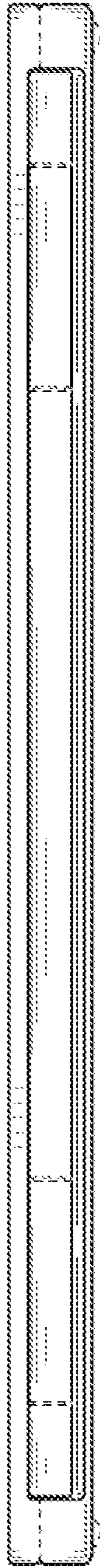

FIG. 4

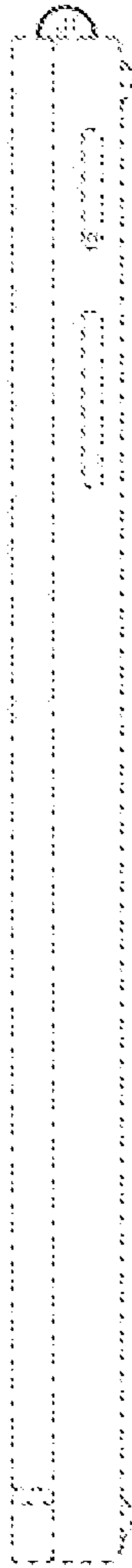

FIG. 5

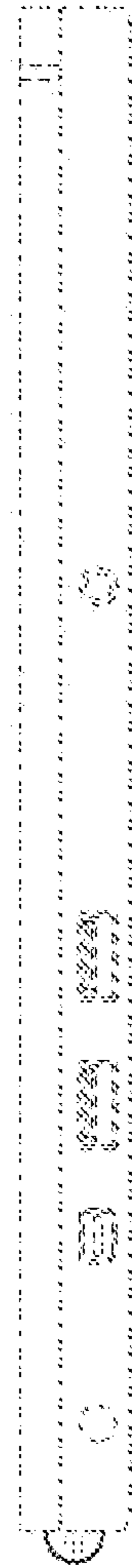

FIG. 6

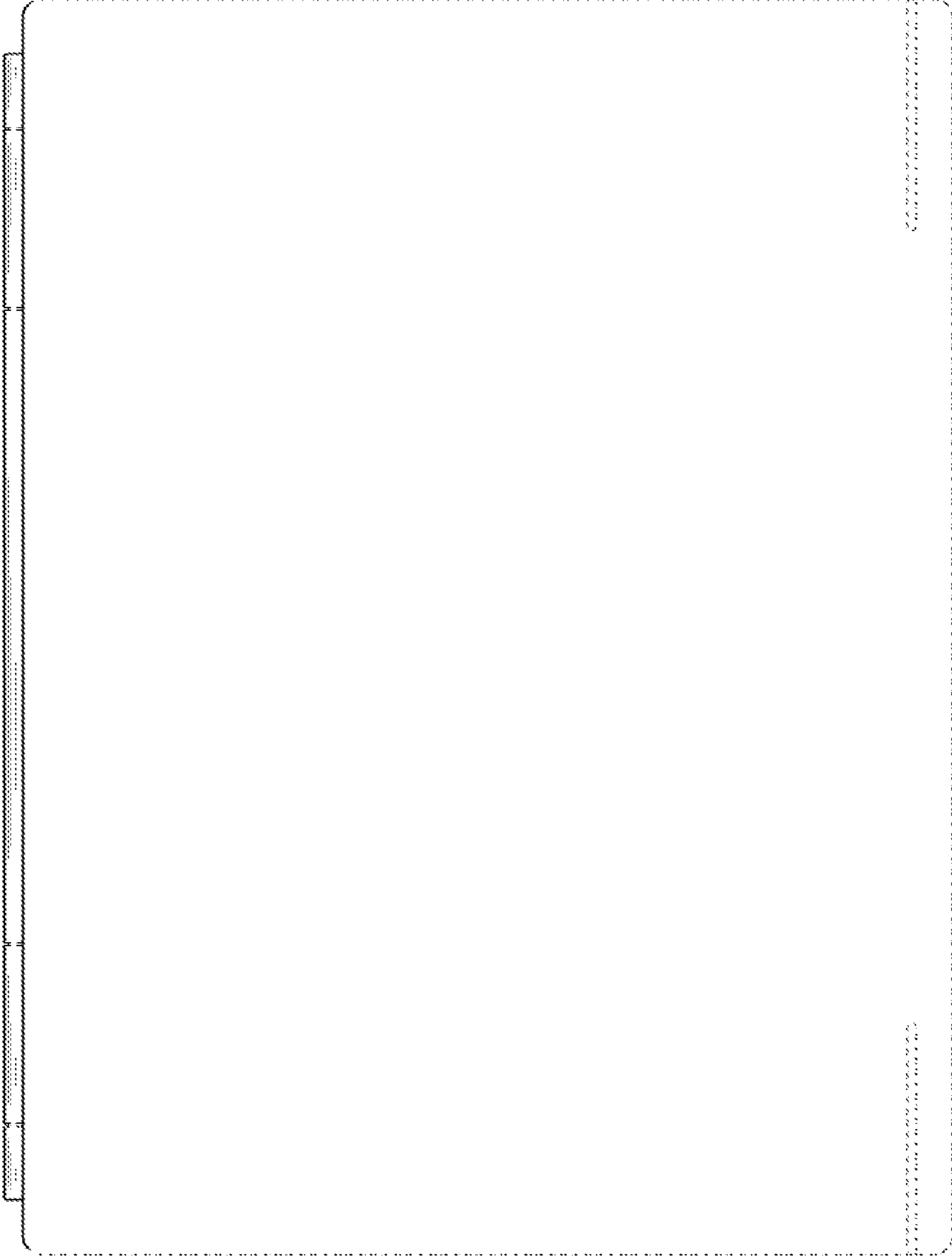

FIG. 7

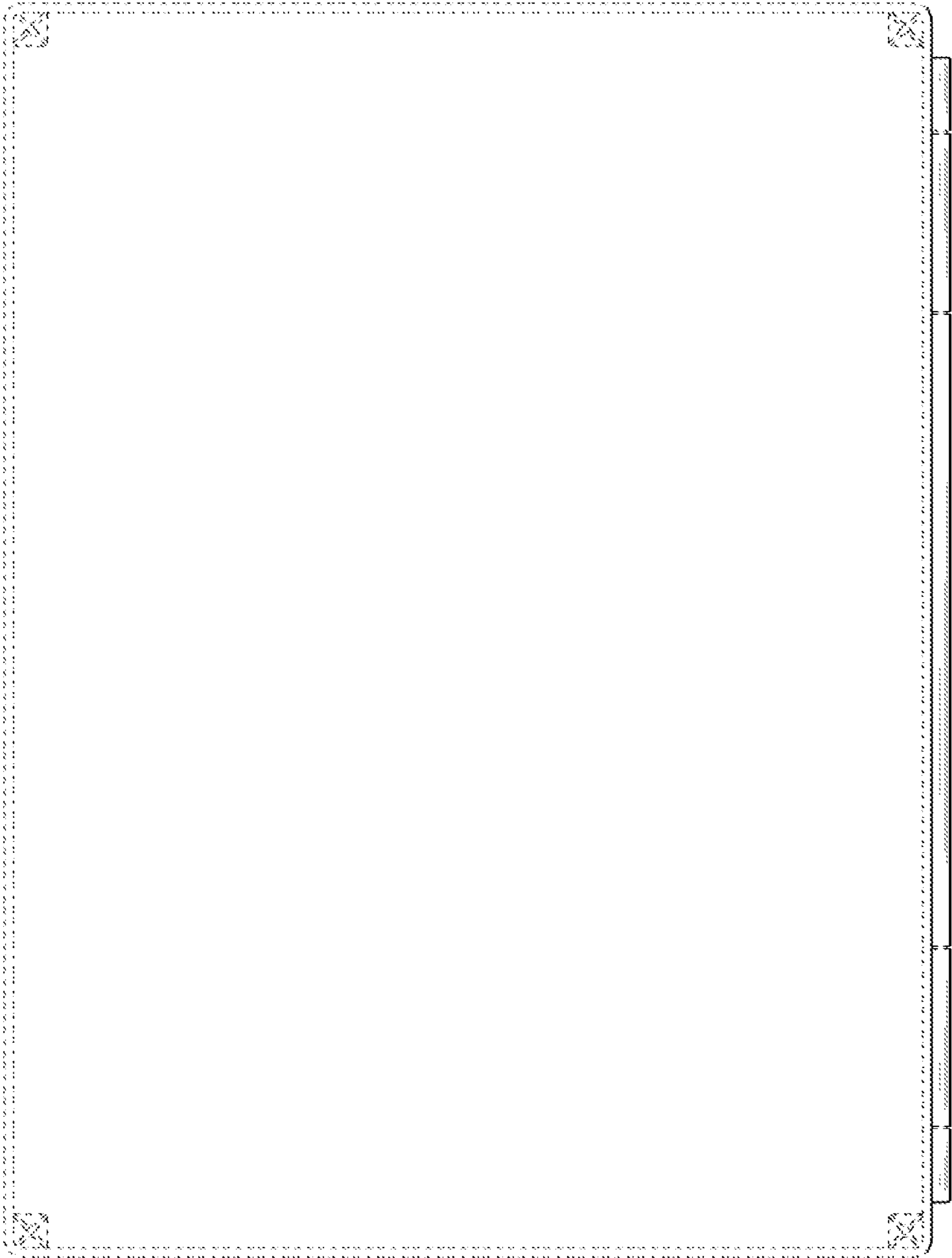

FIG. 8