



US00D708537S

(12) **United States Design Patent**  
**Marney**

(10) **Patent No.:** **US D708,537 S**  
(45) **Date of Patent:** **\*\* Jul. 8, 2014**

- (54) **MINIATURE DUCK CALL**
- (71) Applicant: **Benny Marney**, Rockwood, TN (US)
- (72) Inventor: **Benny Marney**, Rockwood, TN (US)
- (\*\*) Term: **14 Years**
- (21) Appl. No.: **29/472,691**
- (22) Filed: **Nov. 14, 2013**
- (51) **LOC (10) Cl.** ..... **10-05**
- (52) **U.S. Cl.**  
USPC ..... **D10/119.1**
- (58) **Field of Classification Search**  
CPC ..... A01M 31/04; A01M 31/004  
USPC ..... D10/119.1-119.3; 446/193, 213,  
446/202-207; 368/14; 363/196, 353;  
116/137 R; 70/456 R  
See application file for complete search history.

D405,378 S *	2/1999	Rhodes	.....	D10/119.2
D441,679 S *	5/2001	Foiles	.....	D10/119.2
6,254,451 B1 *	7/2001	Bean	.....	446/207
6,435,933 B1 *	8/2002	Browne	.....	446/207
6,709,309 B1 *	3/2004	Bishop et al.	.....	446/213
D502,119 S *	2/2005	Primos et al.	.....	D10/119.1
8,016,637 B2 *	9/2011	Pribbanow	.....	446/202
2009/0258566 A1 *	10/2009	May	.....	446/208
2010/0240275 A1 *	9/2010	Rowley et al.	.....	446/208

\* cited by examiner

*Primary Examiner* — George D Kirschbaum  
(74) *Attorney, Agent, or Firm* — Wyatt, Tarrant & Combs, LLP; William S. Parks

(57) **CLAIM**  
The ornamental design for the miniature duck call, as shown and described.

**DESCRIPTION**

FIG. 1 is a perspective view of the miniature duck call showing my new design;  
FIG. 2 is a top side view thereof;  
FIG. 3 is a bottom side view thereof;  
FIG. 4 is a left side view thereof;  
FIG. 5 is a right side view thereof; and,  
FIG. 6 is a cross-sectional view along line 6-6 of FIG. 2 thereof.

**1 Claim, 5 Drawing Sheets**

- (56) **References Cited**  
U.S. PATENT DOCUMENTS  
3,815,283 A \* 6/1974 Piper ..... 446/202  
3,955,313 A \* 5/1976 Faulk ..... 446/208  
4,950,198 A \* 8/1990 Repko, Jr. .... 446/207  
4,950,201 A \* 8/1990 Sceery ..... 446/207  
5,549,498 A \* 8/1996 Kirby ..... 446/193

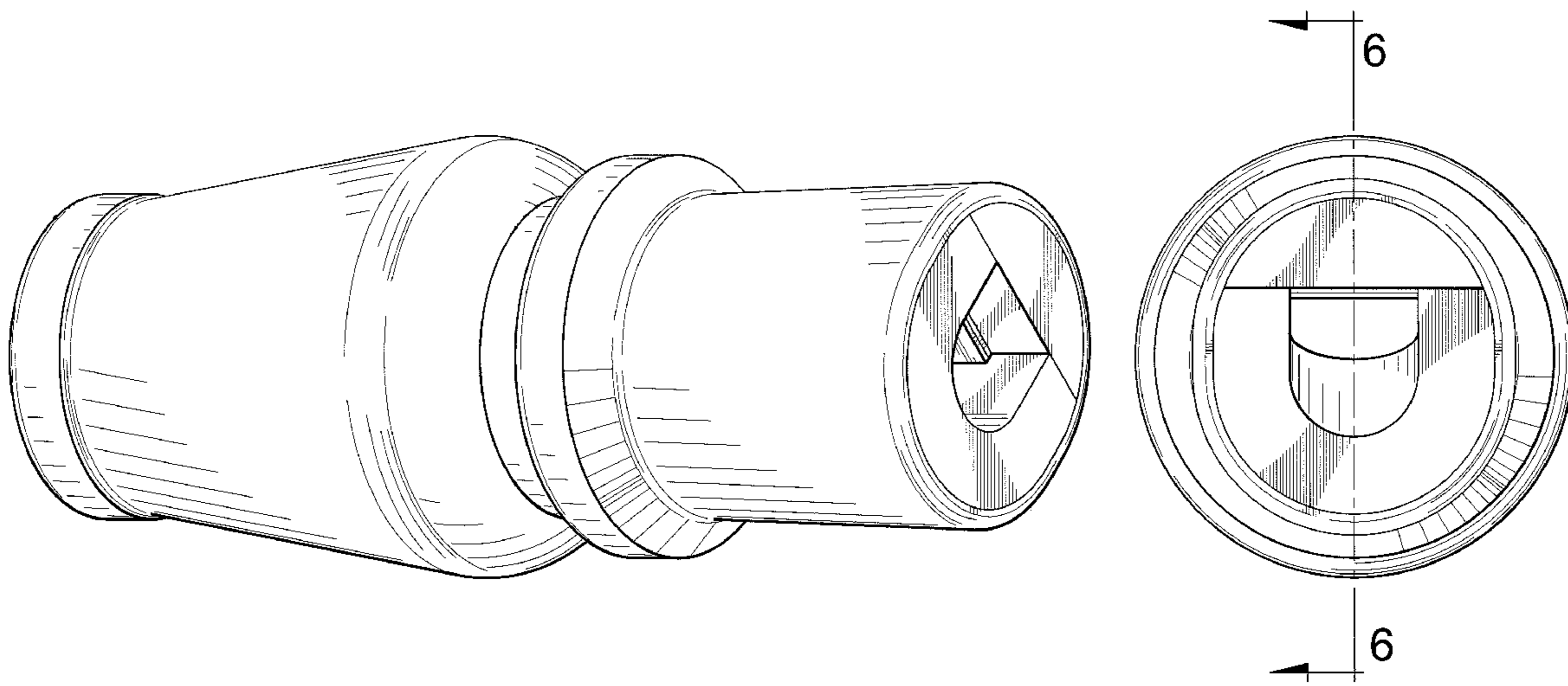

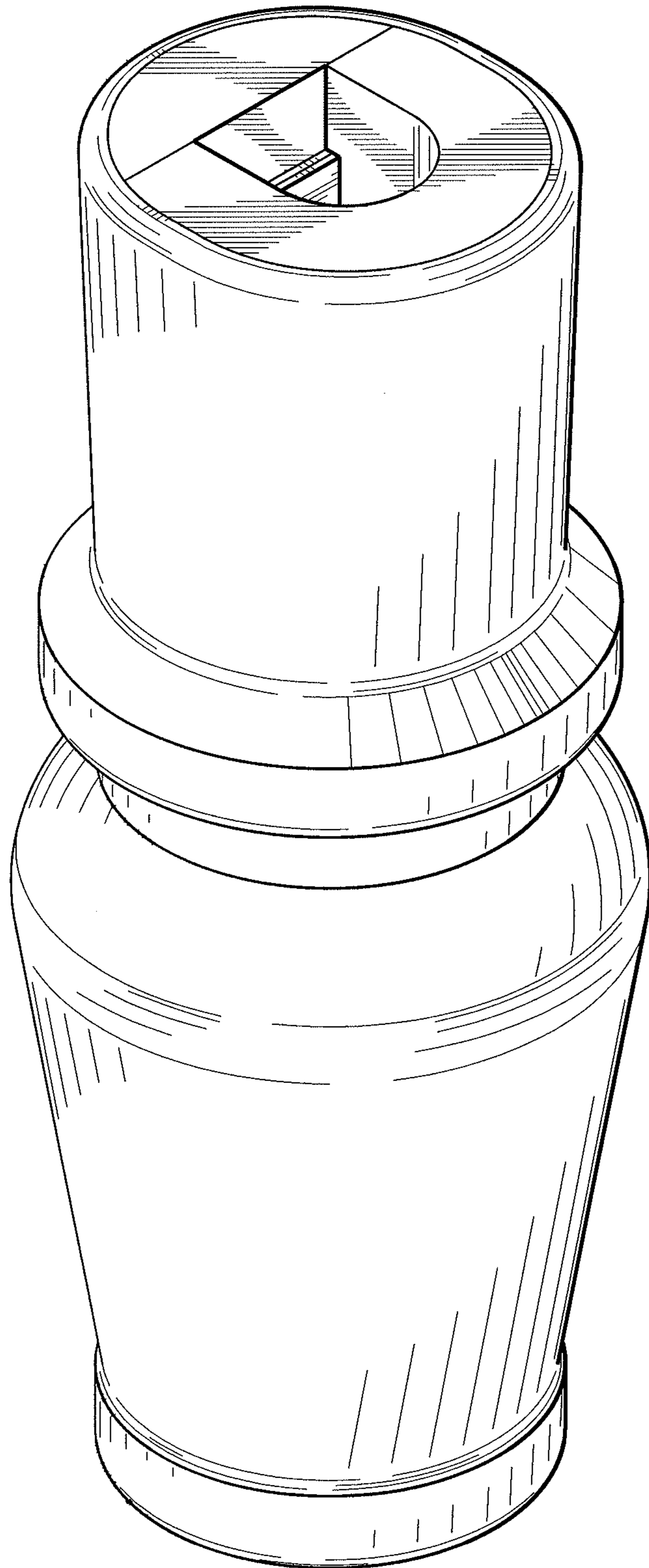

FIG. 1

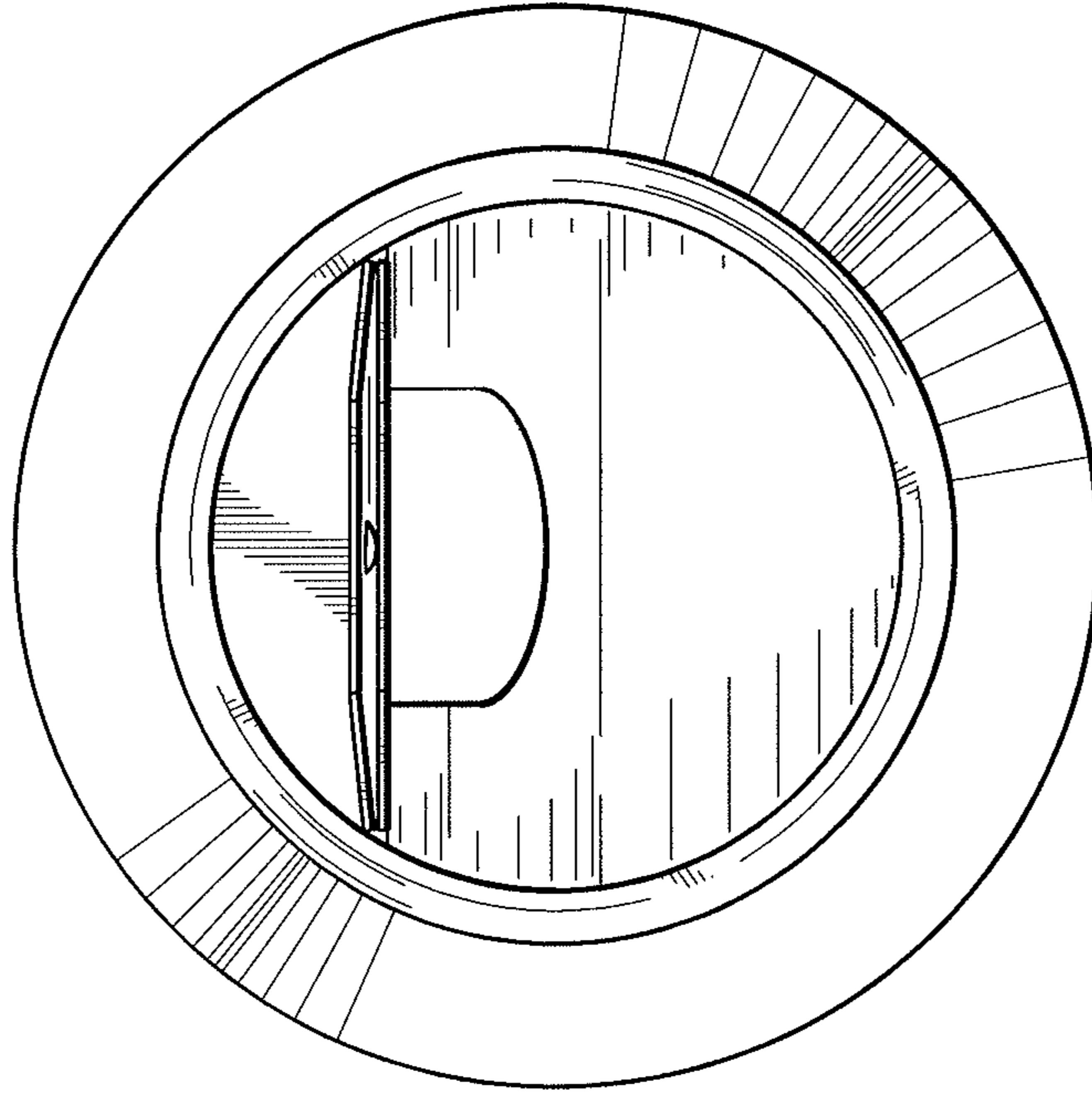

FIG. 3

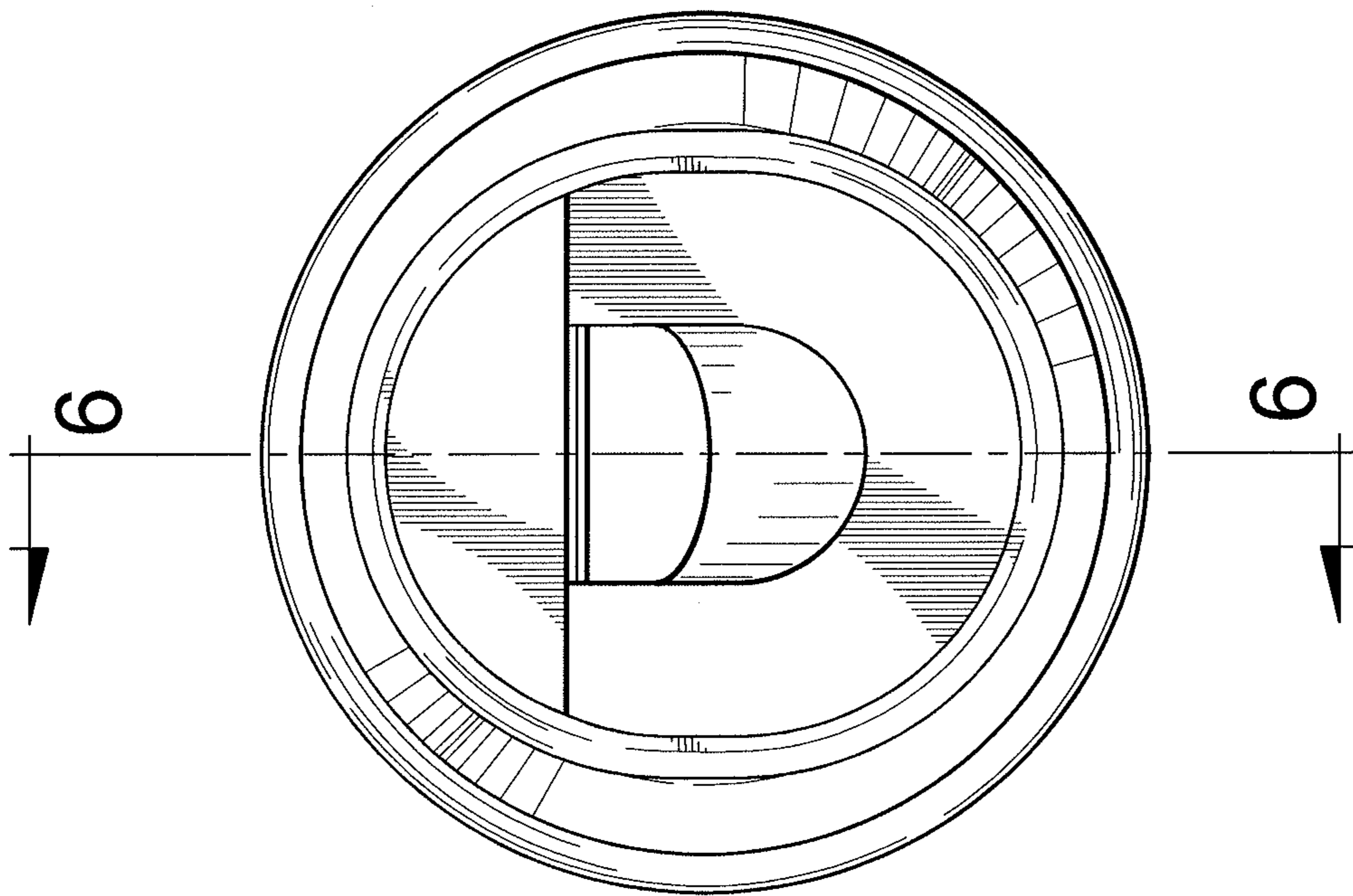

FIG. 2

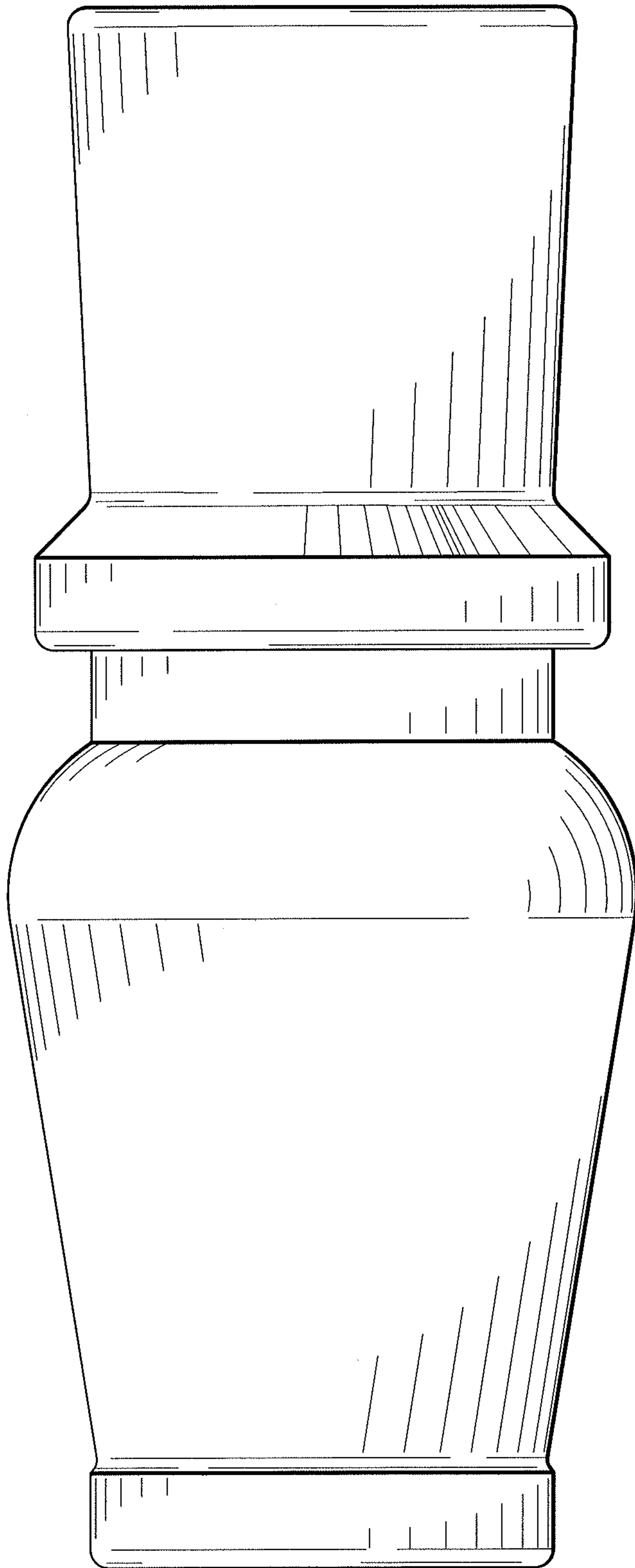

FIG. 4

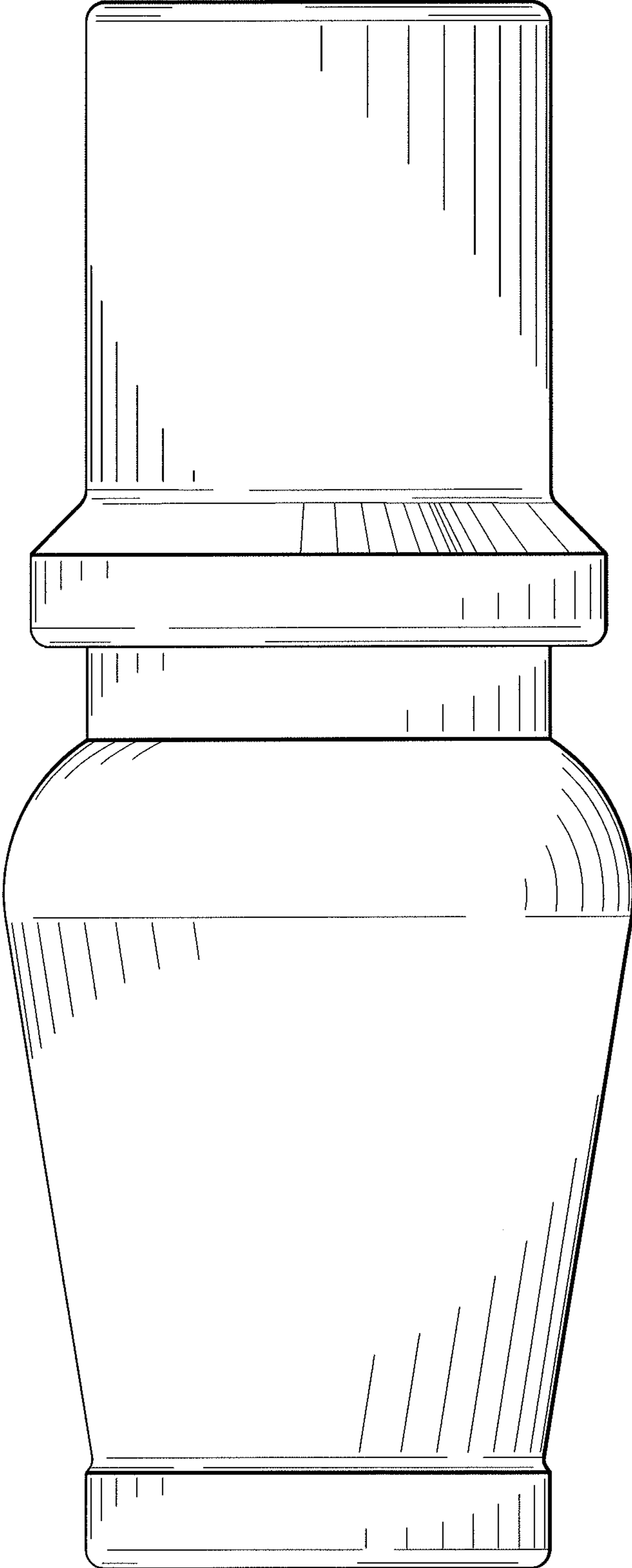

FIG. 5

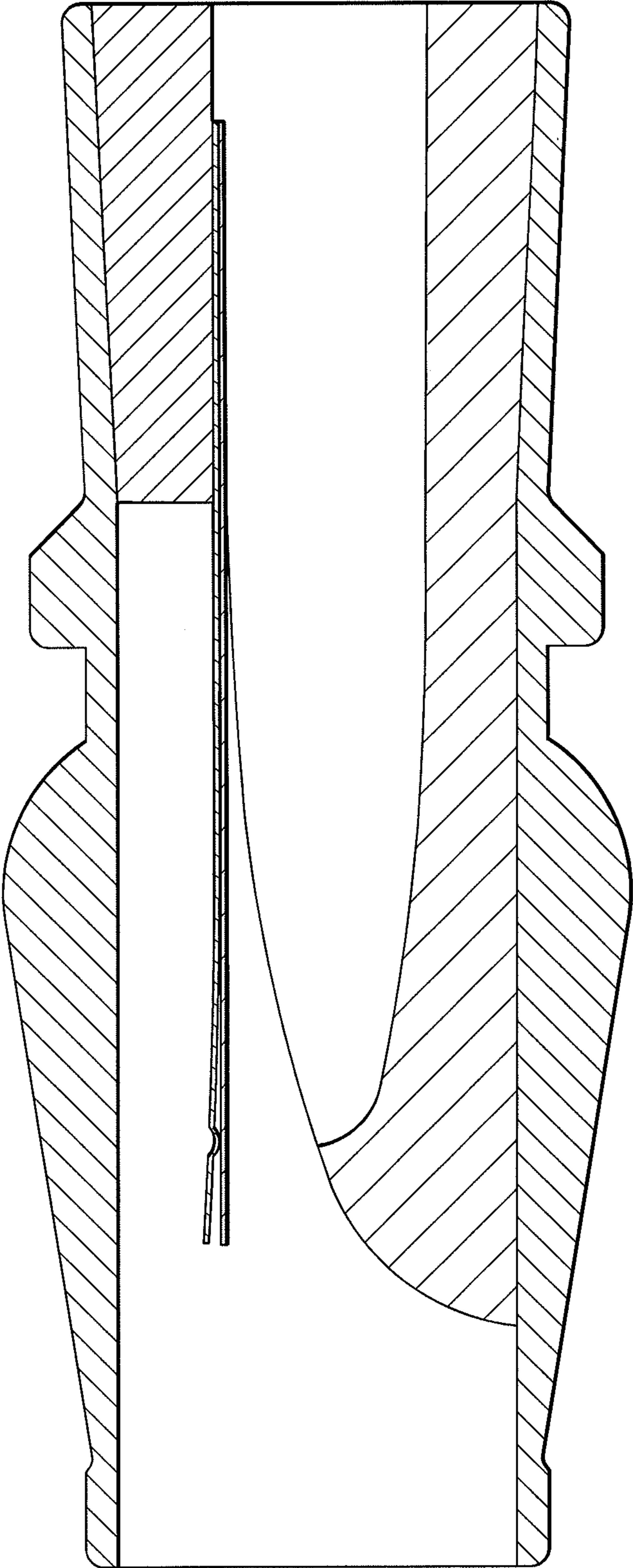

FIG. 6