



US00D708524S

(12) **United States Design Patent**
White et al.

(10) **Patent No.:** **US D708,524 S**
(45) **Date of Patent:** **** Jul. 8, 2014**

- (54) **DROPPER BOTTLE**
- (71) Applicant: **Access Business Group International LLC**, Ada, MI (US)
- (72) Inventors: **Mark K. White**, Grand Rapids, MI (US); **Joe D. Doucet**, New York, NY (US)
- (73) Assignee: **Access Business Group International LLC**, Ada, MI (US)
- (**) Term: **14 Years**
- (21) Appl. No.: **29/455,137**
- (22) Filed: **May 17, 2013**
- (51) **LOC (10) Cl.** **09-01**
- (52) **U.S. Cl.**
USPC **D9/504**
- (58) **Field of Classification Search**
CPC B65D 1/00; B65D 1/02; B65D 1/0223;
B65D 1/0246; B65D 41/00; B65D 41/02;
B65D 41/04; B65D 2501/00; B65D 2501/0009
USPC D9/434-435, 444-445, 454, 500,
D9/503-505, 516, 529, 549, 558, 575, 682,
D9/686, 688-691; 215/316, 329, 379,
215/381-382; 220/288, 660, 669, 675
See application file for complete search history.

D344,231 S *	2/1994	Gagnon	D9/686
D472,812 S *	4/2003	Lerolle	D9/504
D483,662 S *	12/2003	Castro Lopez	D9/694
D538,483 S *	3/2007	Bakic	D28/89
D555,000 S *	11/2007	Bunce et al.	D9/529
D561,594 S *	2/2008	Condon et al.	D9/529
D563,223 S *	3/2008	Cornet et al.	D9/504
D606,417 S *	12/2009	Castelnuovo-Tedesco	D9/600
D614,961 S *	5/2010	Thomas et al.	D9/529
D623,949 S *	9/2010	Thronsen	D9/504
D663,630 S *	7/2012	White et al.	D9/688
D665,267 S *	8/2012	Dittmer et al.	D9/688
D675,100 S *	1/2013	Herbst	D9/504
D691,889 S *	10/2013	Mettler et al.	D9/504

FOREIGN PATENT DOCUMENTS

WO DM/079027 * 7/2012

* cited by examiner

Primary Examiner — Ian Simmons

Assistant Examiner — Dana L Meyrow

(74) *Attorney, Agent, or Firm* — Warner Norcross & Judd LLP

(57) **CLAIM**

The ornamental design for a dropper bottle, as shown and described.

DESCRIPTION

FIG. 1 is a perspective view of the dropper bottle embodying the new design;
 FIG. 2 is a right side view of the design, the left side view being a mirror image thereof;
 FIG. 3 is a front view thereof;
 FIG. 4 is a rear view thereof;
 FIG. 5 is a top view thereof; and,
 FIG. 6 is a bottom view thereof.
 The portions shown in broken lines in FIGS. 1-4 and 6 form no part of the claimed design.

1 Claim, 2 Drawing Sheets

(56) **References Cited**
U.S. PATENT DOCUMENTS

D276,597 S *	12/1984	Harris	D9/435
D283,592 S *	4/1986	Quarrell et al.	D6/512
D284,119 S *	6/1986	Holloway	D28/89
D285,730 S *	9/1986	Bulwick	D28/7
D307,111 S *	4/1990	Green	D9/741
D315,292 S *	3/1991	Seager	D9/688
D317,253 S *	6/1991	Seager	D9/689
D324,174 S *	2/1992	Litton	D9/521

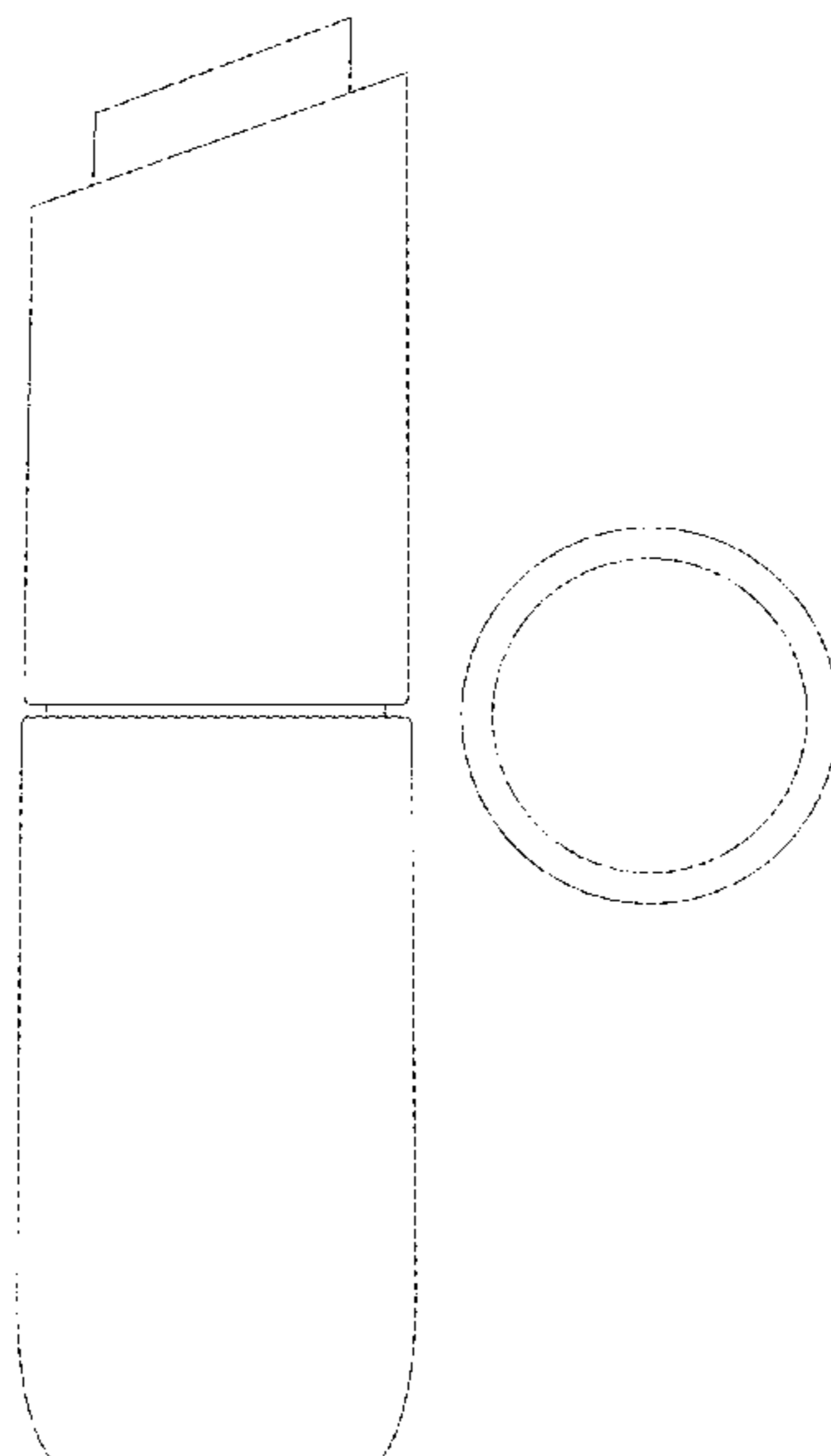

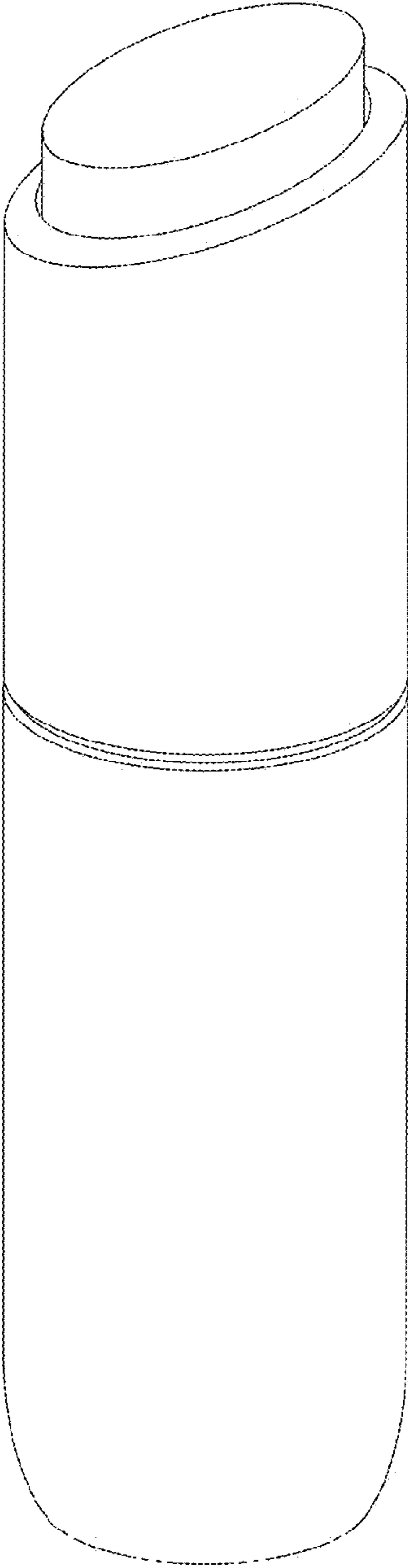

Fig. 1

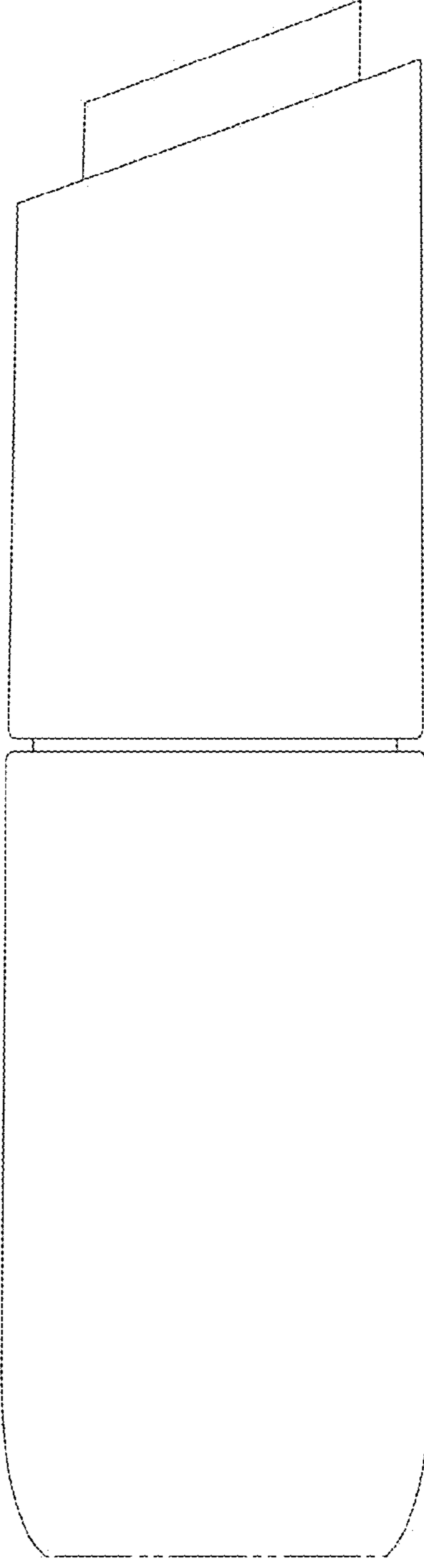

Fig. 2

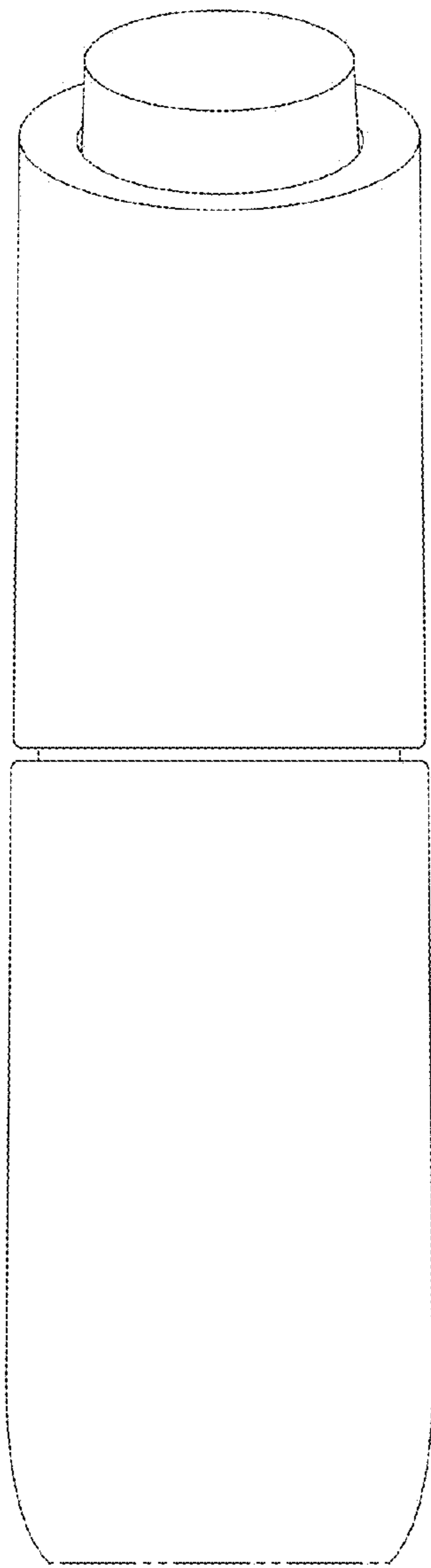

Fig. 3

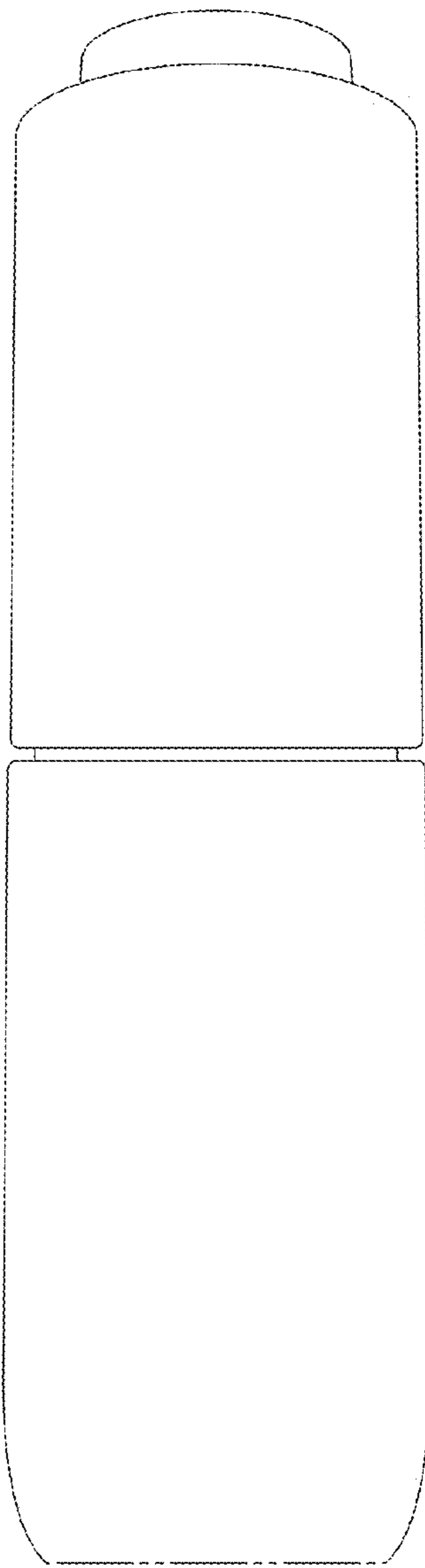

Fig. 4

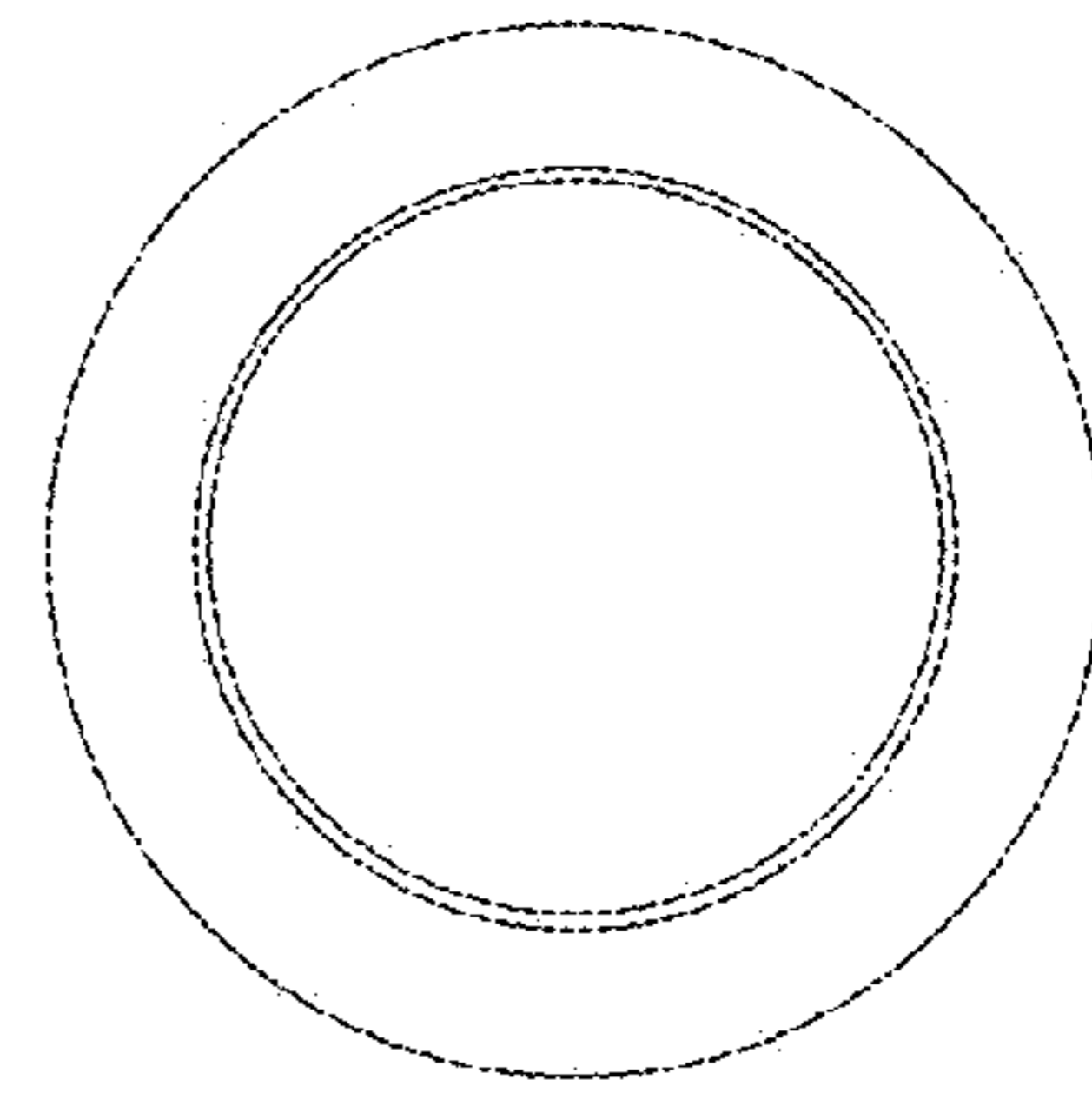

Fig. 5

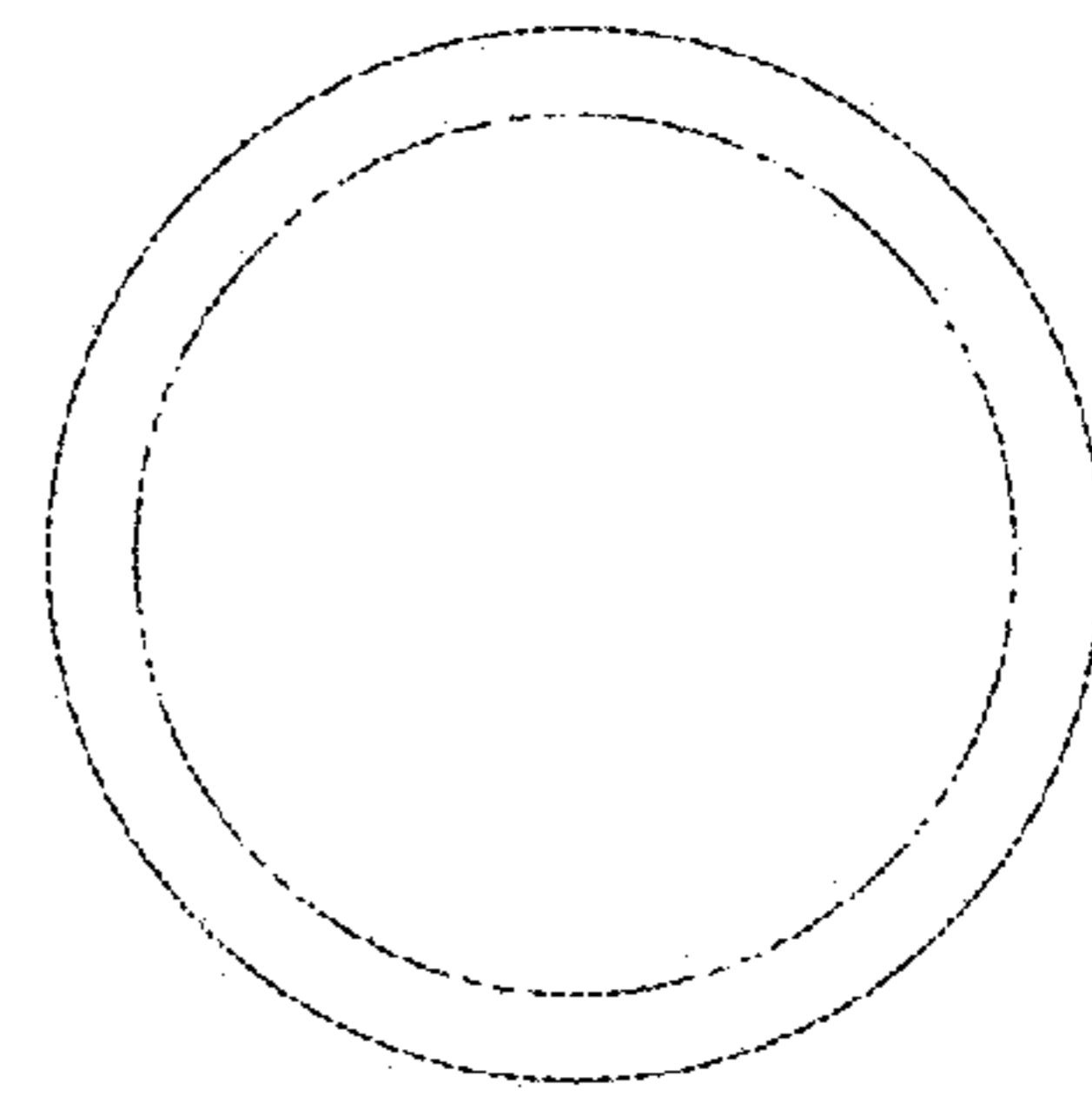

Fig. 6