



US00D708476S

(12) **United States Design Patent**  
**Wandrup**

(10) **Patent No.:** **US D708,476 S**  
(45) **Date of Patent:** **\*\* Jul. 8, 2014**

- (54) **KNIFE**
- (71) Applicant: **Iittala Group Oy Ab**, Helsinki (FI)
- (72) Inventor: **Tobias Wandrup**, Copenhagen (DK)
- (73) Assignee: **Fiskars Home Oy Ab**, Helsinki (FI)
- (\*\*) Term: **14 Years**
- (21) Appl. No.: **29/473,848**
- (22) Filed: **Nov. 26, 2013**

- D595,544 S 7/2009 Thun
- D623,483 S 9/2010 Gerlach
- D629,260 S 12/2010 Krent
- D632,934 S 2/2011 Thun

(Continued)

**OTHER PUBLICATIONS**

Russian Office Action, dated Feb. 7, 2013, Russian Patent Application No. 2012502266, with English Translation.

*Primary Examiner* — Ricky Pham

(74) *Attorney, Agent, or Firm* — Andrus Intellectual Property Law, LLP

**Related U.S. Application Data**

- (62) Division of application No. 29/430,278, filed on Aug. 23, 2012, now Pat. No. Des. 697,377.

(57) **CLAIM**

The ornamental design for a knife, as shown and described.

**DESCRIPTION**

(30) **Foreign Application Priority Data**

- Feb. 27, 2012 (EM) ..... 001998469-0004
- Feb. 27, 2012 (EM) ..... 001998469-0005
- Feb. 27, 2012 (EM) ..... 001998469-0006
- Feb. 27, 2012 (EM) ..... 001998469-0007
- Feb. 27, 2012 (EM) ..... 001998469-0008

FIG. 1 is a perspective view of a further embodiment of my new design;  
 FIG. 2 is a left side view thereof;  
 FIG. 3 is a right side view thereof, wherein the right side is a mirror image of the left side;  
 FIG. 4 is a top view thereof;  
 FIG. 5 is a bottom view thereof;  
 FIG. 6 is an enlarged front perspective view thereof;  
 FIG. 7 is an enlarged rear perspective view thereof;  
 FIG. 8 is a perspective view of a further embodiment of my new design;  
 FIG. 9 is a left side view thereof;  
 FIG. 10 is a right side view thereof, wherein the right side is a mirror image of the left side;  
 FIG. 11 is a top view thereof;  
 FIG. 12 is a bottom view thereof;  
 FIG. 13 is an enlarged front perspective view thereof; and,  
 FIG. 14 is an enlarged rear perspective view thereof.  
 The broken lines in the drawing figures are for the purpose of illustrating environment and form no part of these specified embodiments of the claimed design.

- (51) **LOC (10) Cl.** ..... **07-03**
- (52) **U.S. Cl.**  
USPC ..... **D7/401.2; D7/649**
- (58) **Field of Classification Search**  
USPC ..... D7/393-395, 401.2, 642-652, 693, D7/695-696; D8/93, 97-100, 107, 300, D8/321; D22/117-118; 30/136, 142, 30/147-149, 329, 340-345  
See application file for complete search history.

(56) **References Cited**

**U.S. PATENT DOCUMENTS**

- D458,511 S 6/2002 Rorke
- D473,430 S 4/2003 Fedor et al.
- D513,927 S 1/2006 Chen
- D524,121 S 7/2006 Loeb

**1 Claim, 8 Drawing Sheets**

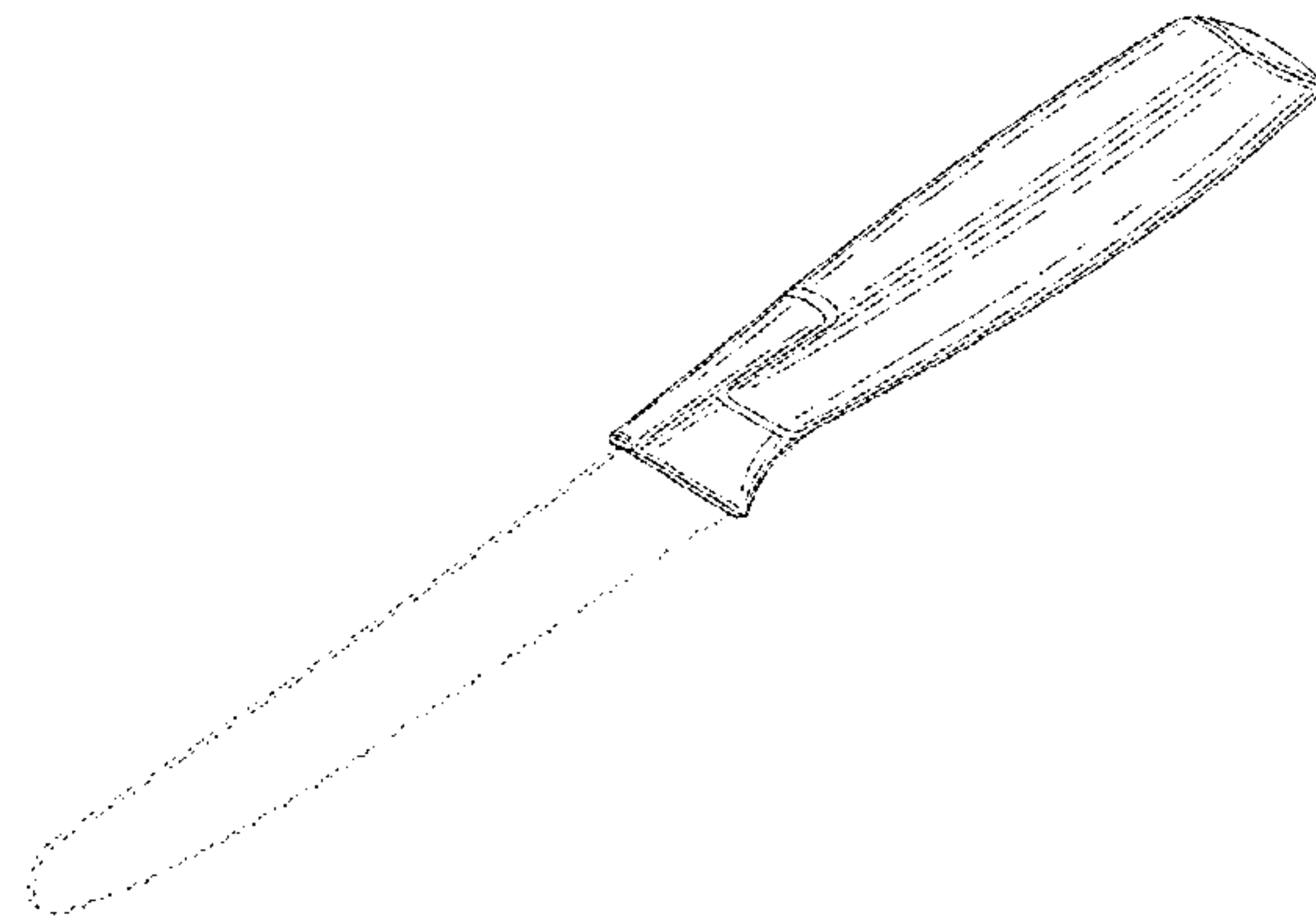
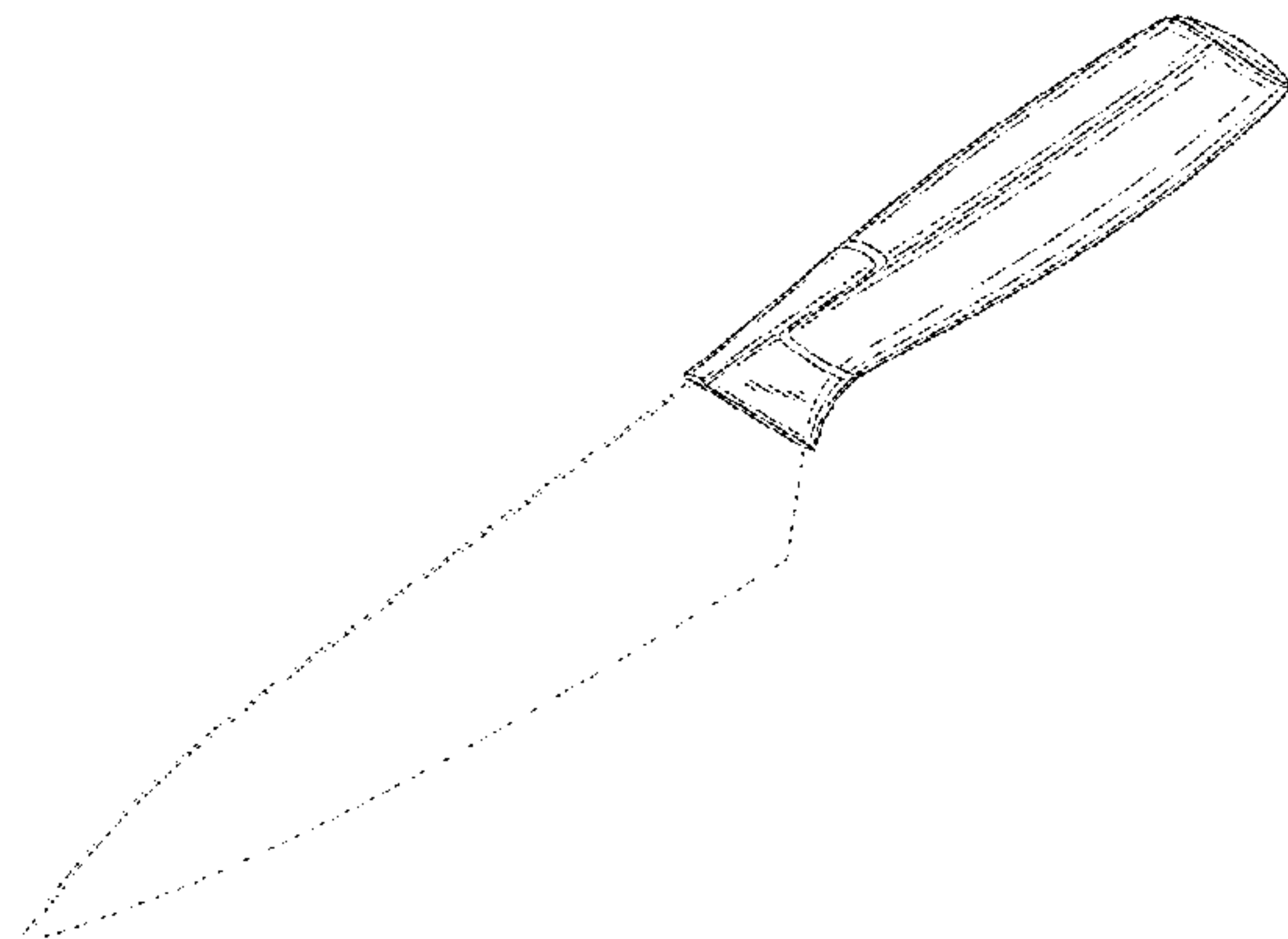

(56)

**References Cited**

U.S. PATENT DOCUMENTS

D649,412 S 11/2011 Lo  
D649,840 S \* 12/2011 Lo ..... D7/649  
D649,841 S \* 12/2011 Lo ..... D7/649  
D660,097 S 5/2012 Chen

D660,098 S 5/2012 Chen  
D661,554 S 6/2012 Thomkins  
D674,670 S 1/2013 Thun  
D688,913 S \* 9/2013 Lo ..... D7/401.2  
D693,642 S \* 11/2013 Chen ..... D7/401.2  
D697,377 S \* 1/2014 Wandrup ..... D7/649  
D698,615 S \* 2/2014 Wandrup ..... D7/649  
\* cited by examiner

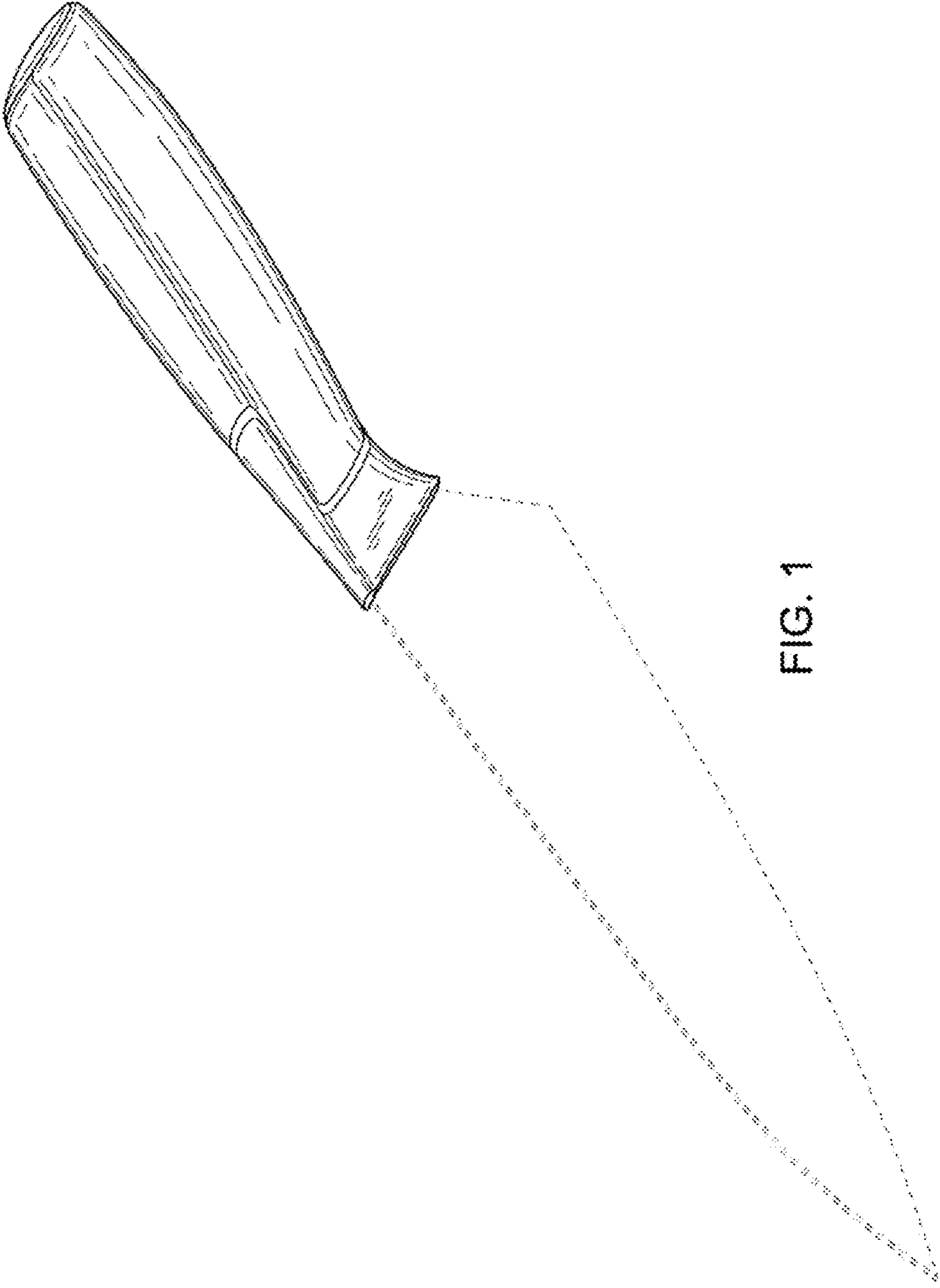

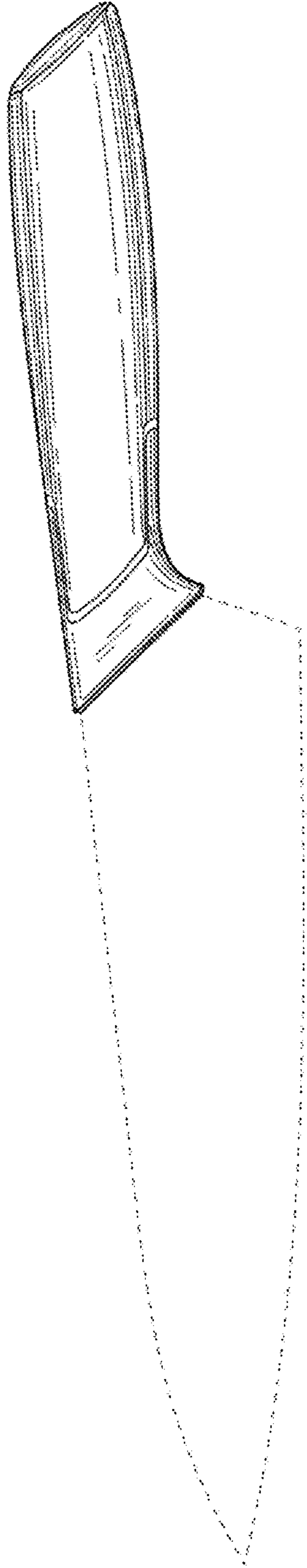

FIG. 2

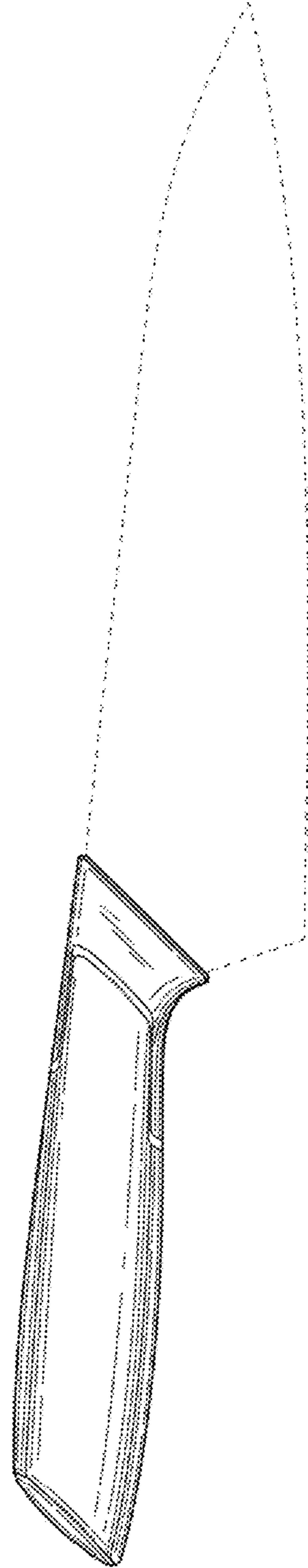

FIG. 3

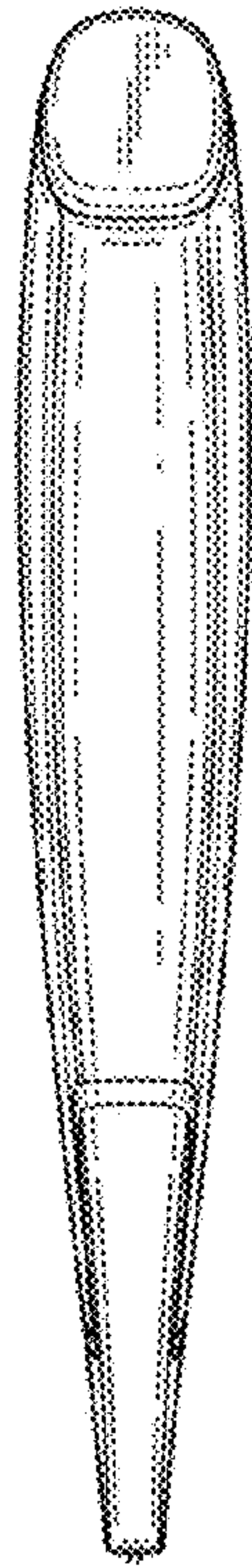

FIG. 4

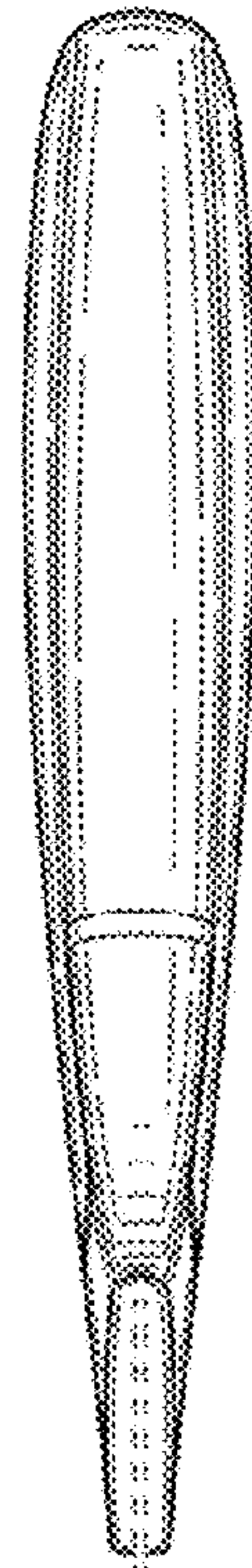
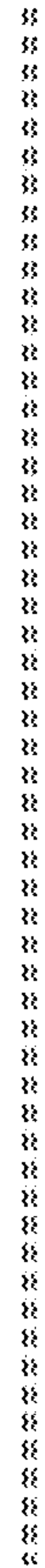
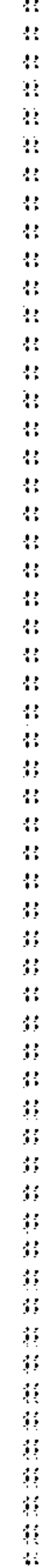

FIG. 5





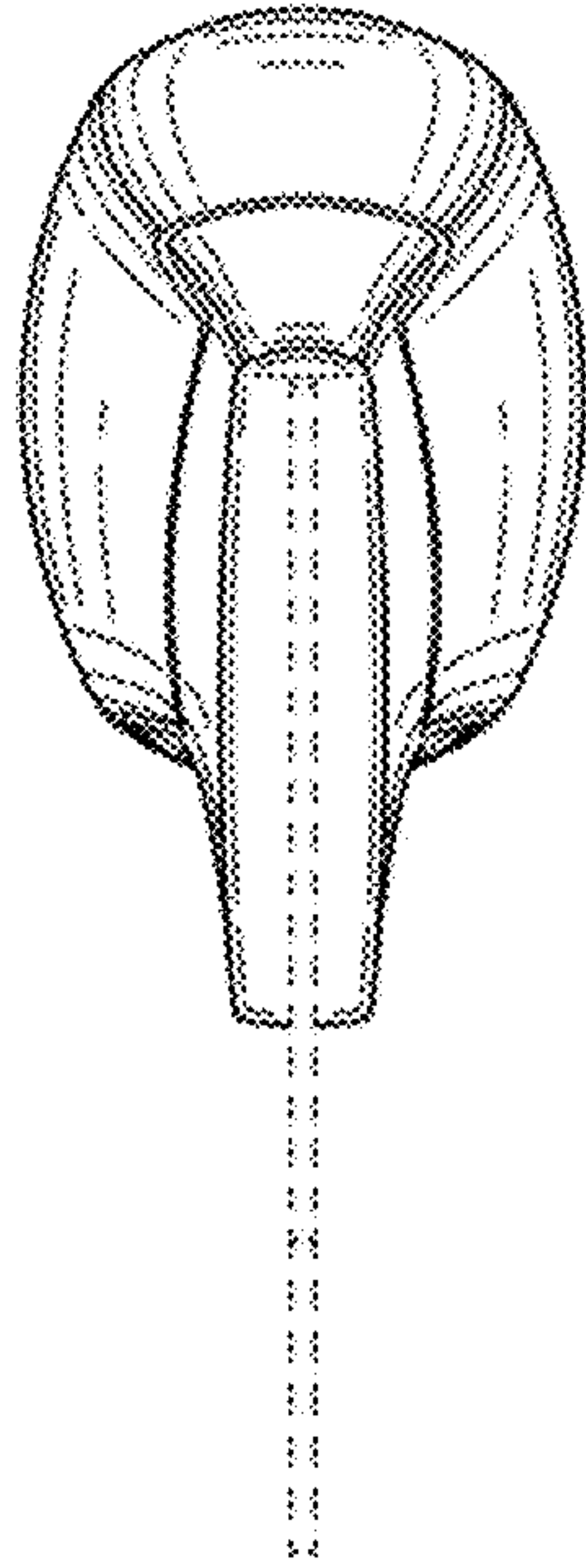

FIG. 6

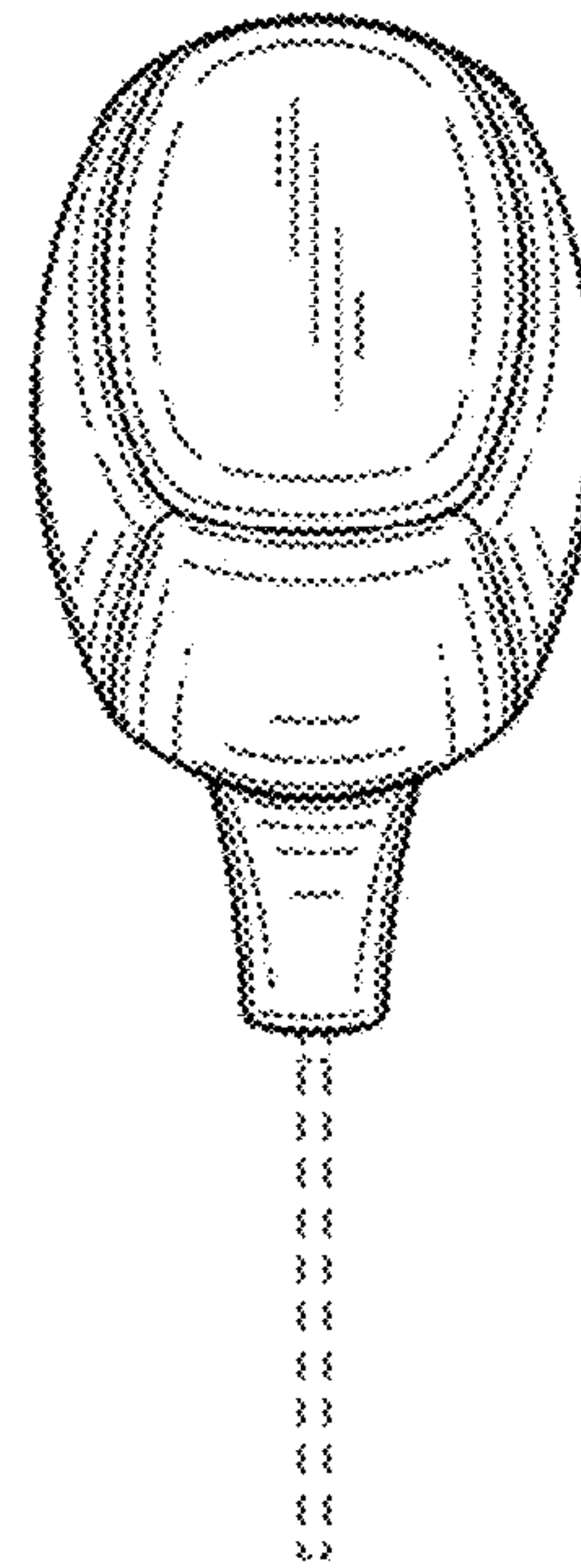

FIG. 7

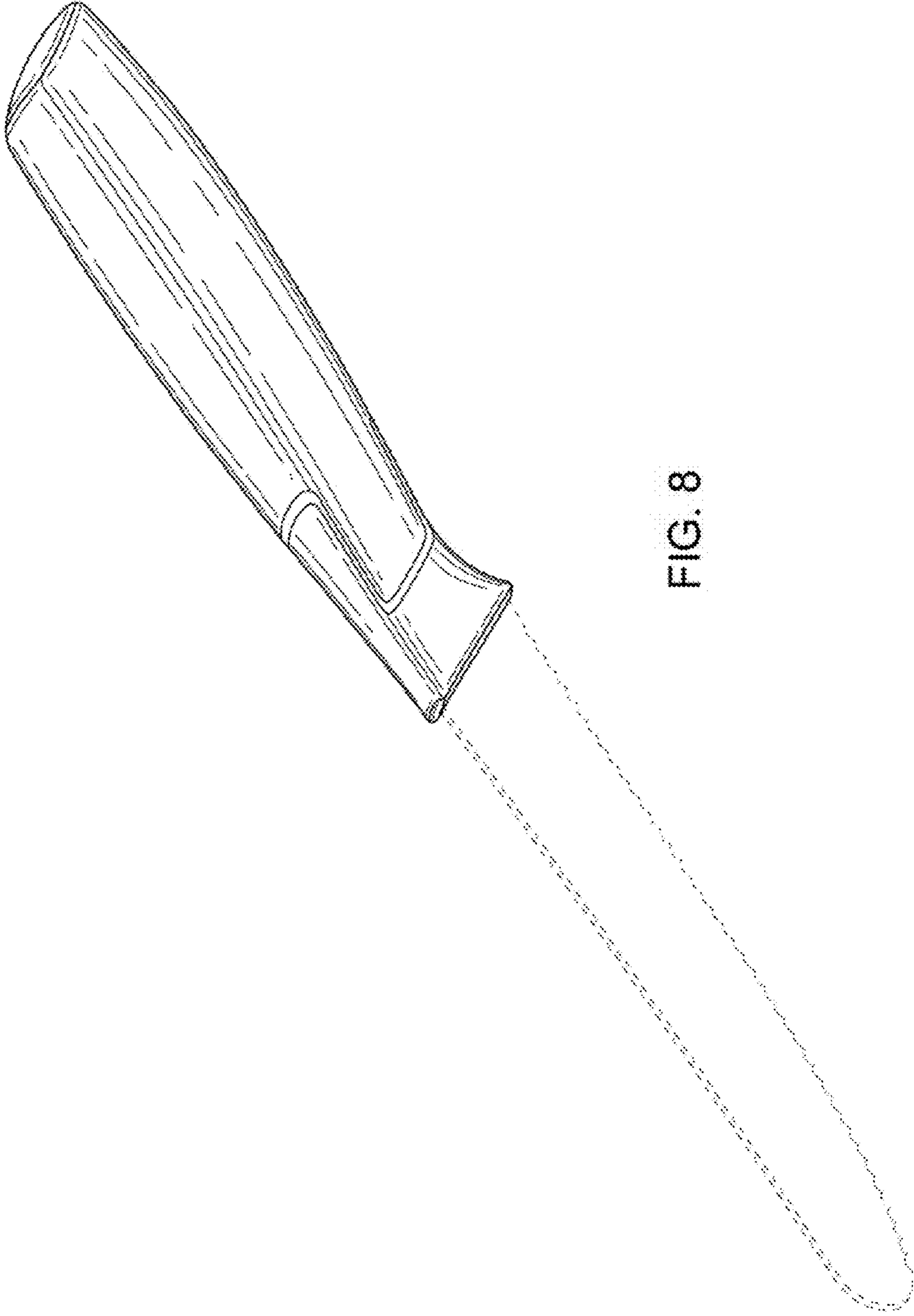

FIG. 8

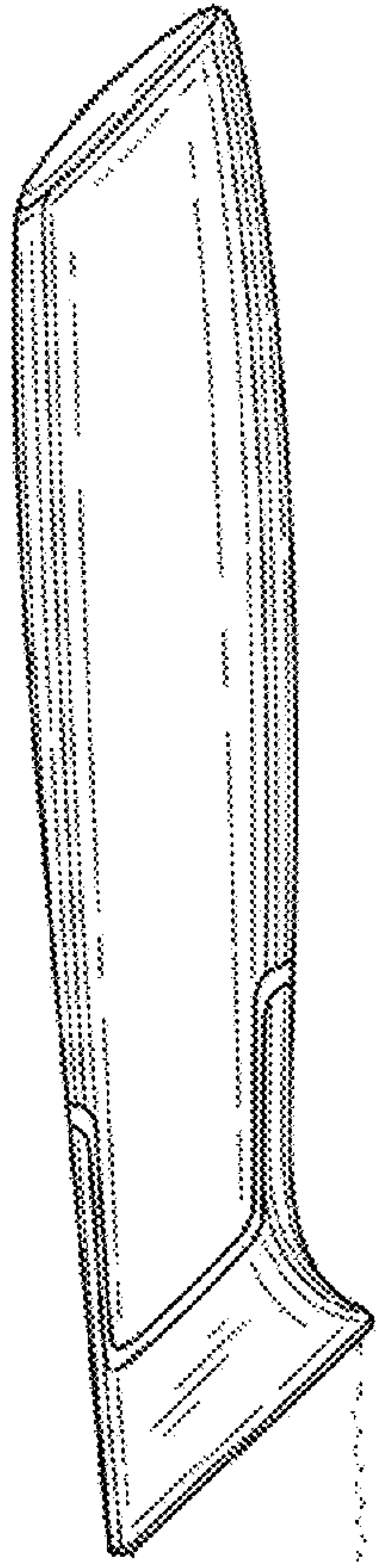

FIG. 9

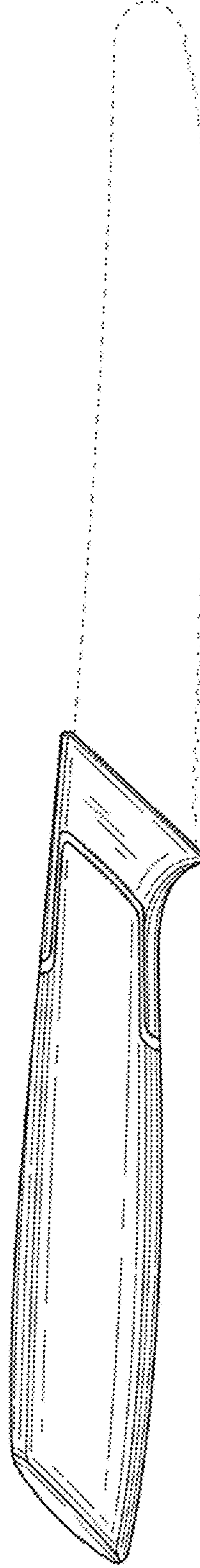

FIG. 10



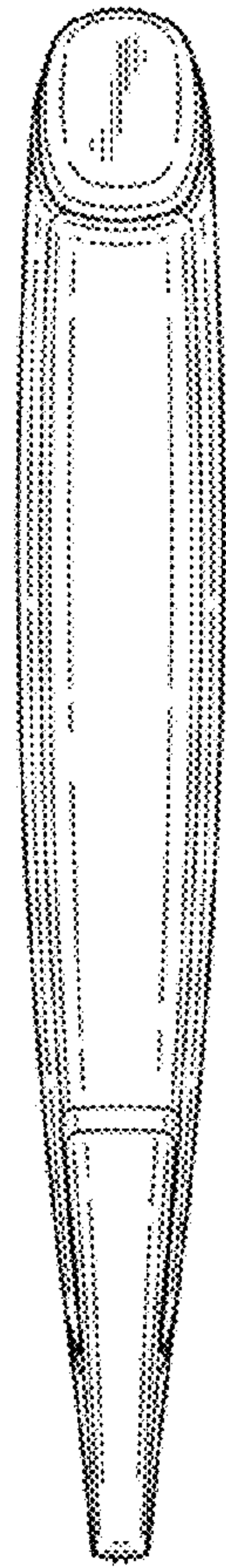

FIG. 11

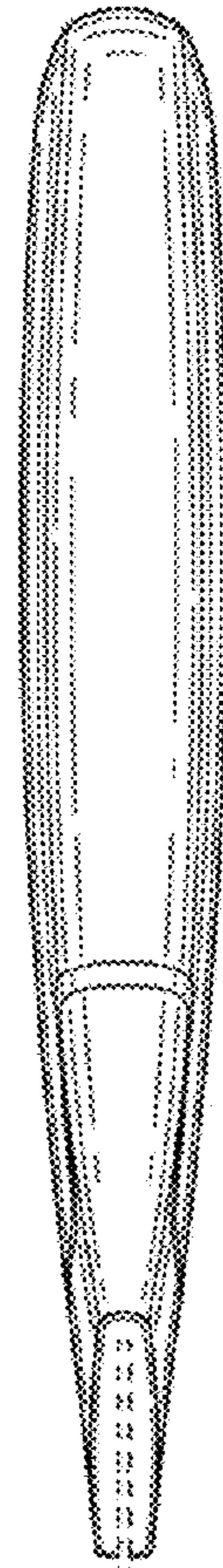

FIG. 12

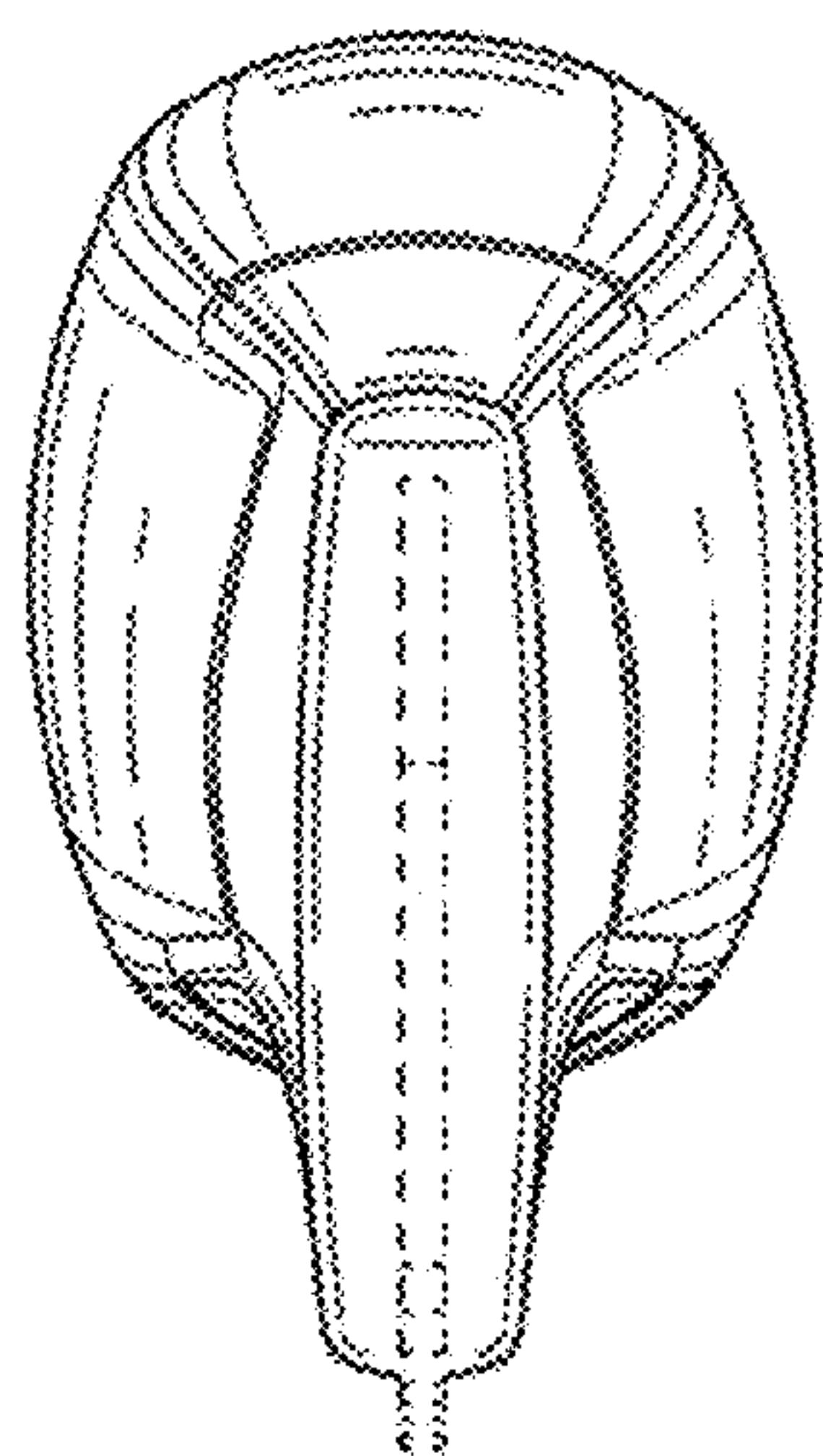

FIG. 13

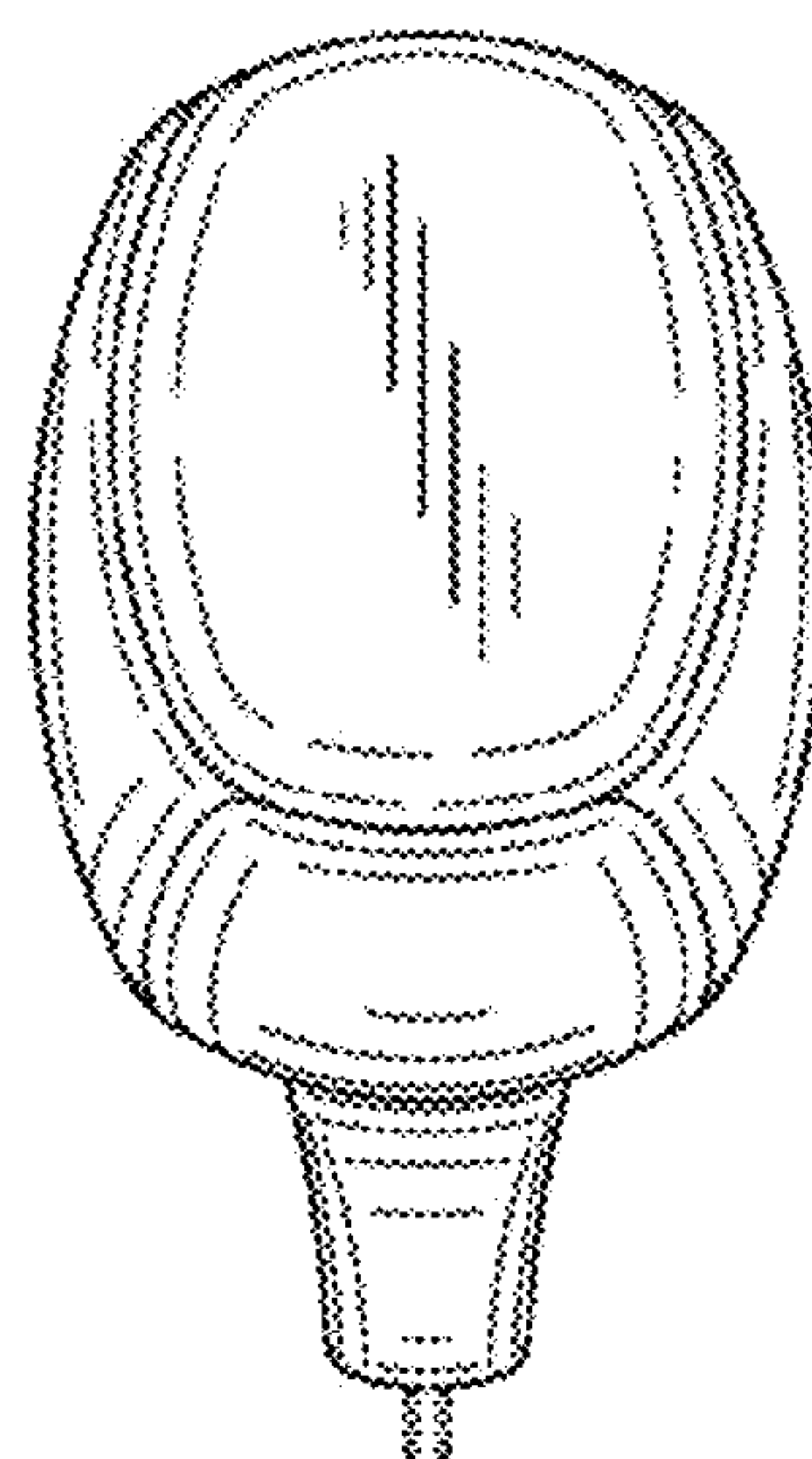

FIG. 14