



US00D708400S

(12) **United States Design Patent**
Hinrichs

(10) **Patent No.:** **US D708,400 S**
(45) **Date of Patent:** **** Jul. 1, 2014**

(54) **HUMMINGBIRD FEEDER**

(75) Inventor: **Gregory Hinrichs**, Irvine, CA (US)

(73) Assignee: **Woodstream Corporation**, Lititz, PA (US)

(**) Term: **14 Years**

(21) Appl. No.: **29/426,309**

(22) Filed: **Jul. 3, 2012**

(51) **LOC (10) Cl.** **30-03**

(52) **U.S. Cl.**
USPC **D30/124**

(58) **Field of Classification Search**
USPC D30/121, 124-128, 133; 119/51.01, 119/52.2-52.4, 57.8, 57.9, 248, 77; 248/219.1, 222.11, 224.7, 229.1, 248/230.1, 689; D10/114.9; D22/117; D21/400; D16/132

See application file for complete search history.

(56) **References Cited**

U.S. PATENT DOCUMENTS

2,189,505	A *	2/1940	Laos	132/258
3,131,593	A *	5/1964	Grow	359/616
3,173,429	A *	3/1965	Pauldine	132/234
D205,674	S *	9/1966	Powers	D21/403
D234,863	S *	4/1975	Karelitz	D21/403
3,884,547	A *	5/1975	Parrino	359/617
4,114,187	A *	9/1978	Uke	362/158
D256,404	S *	8/1980	Barfod	D3/10
4,231,634	A *	11/1980	Gantz et al.	359/617
D271,032	S *	10/1983	Bennett	D21/403
4,494,820	A *	1/1985	Klawitter	359/616
D288,700	S *	3/1987	Kalish	D21/403
D289,451	S *	4/1987	Earl	D30/124
D296,478	S *	6/1988	Powell et al.	D26/49
4,762,380	A *	8/1988	MacCarthy	359/616
4,781,644	A *	11/1988	Yoshida	446/123
D302,598	S *	8/1989	Keung	D28/37
4,854,657	A *	8/1989	Scott	359/617

D307,162	S *	4/1990	Hanlon, III	D21/403
D308,109	S *	5/1990	Maglica et al.	D26/49
5,029,954	A *	7/1991	Eilrich et al.	359/617
D319,852	S *	9/1991	Sorensen et al.	D21/403
5,054,865	A *	10/1991	Huang	359/617
5,131,734	A *	7/1992	Hausner	359/617
5,132,844	A *	7/1992	Sharp, Jr.	359/617
D329,303	S *	9/1992	Asakura	D28/37
5,172,270	A *	12/1992	Peiperl	359/617
D333,693	S *	3/1993	Parsons	D22/117
D334,058	S *	3/1993	Noble	D24/116
5,229,884	A *	7/1993	Kelderhouse et al.	359/616
D340,838	S *	11/1993	Lingo	D7/531
5,331,528	A *	7/1994	Chen	362/205
D350,163	S *	8/1994	Jones	D21/403

(Continued)

Primary Examiner — Susan Moon Lee

(74) *Attorney, Agent, or Firm* — Jacobson Holman, PLLC.

(57) **CLAIM**

The ornamental design for a hummingbird feeder, as shown and described.

DESCRIPTION

FIG. 1 is a perspective view of a hummingbird feeder.
 FIG. 2 is an enlarged view of a portion of the hummingbird feeder of FIG. 1.
 FIG. 3 is a front view of the hummingbird feeder.
 FIG. 4A is a top plan view of a first half of the hummingbird feeder.
 FIG. 4B is a top plan view of a second half of the hummingbird feeder.
 FIG. 5A is a right side plan view of a first half of the hummingbird feeder.
 FIG. 5B is a right side plan view of a second half of the hummingbird feeder.
 FIG. 6A is a bottom plan view of a first half of the hummingbird feeder; and,
 FIG. 6B is a bottom plan view of a second half of the hummingbird feeder.

1 Claim, 3 Drawing Sheets

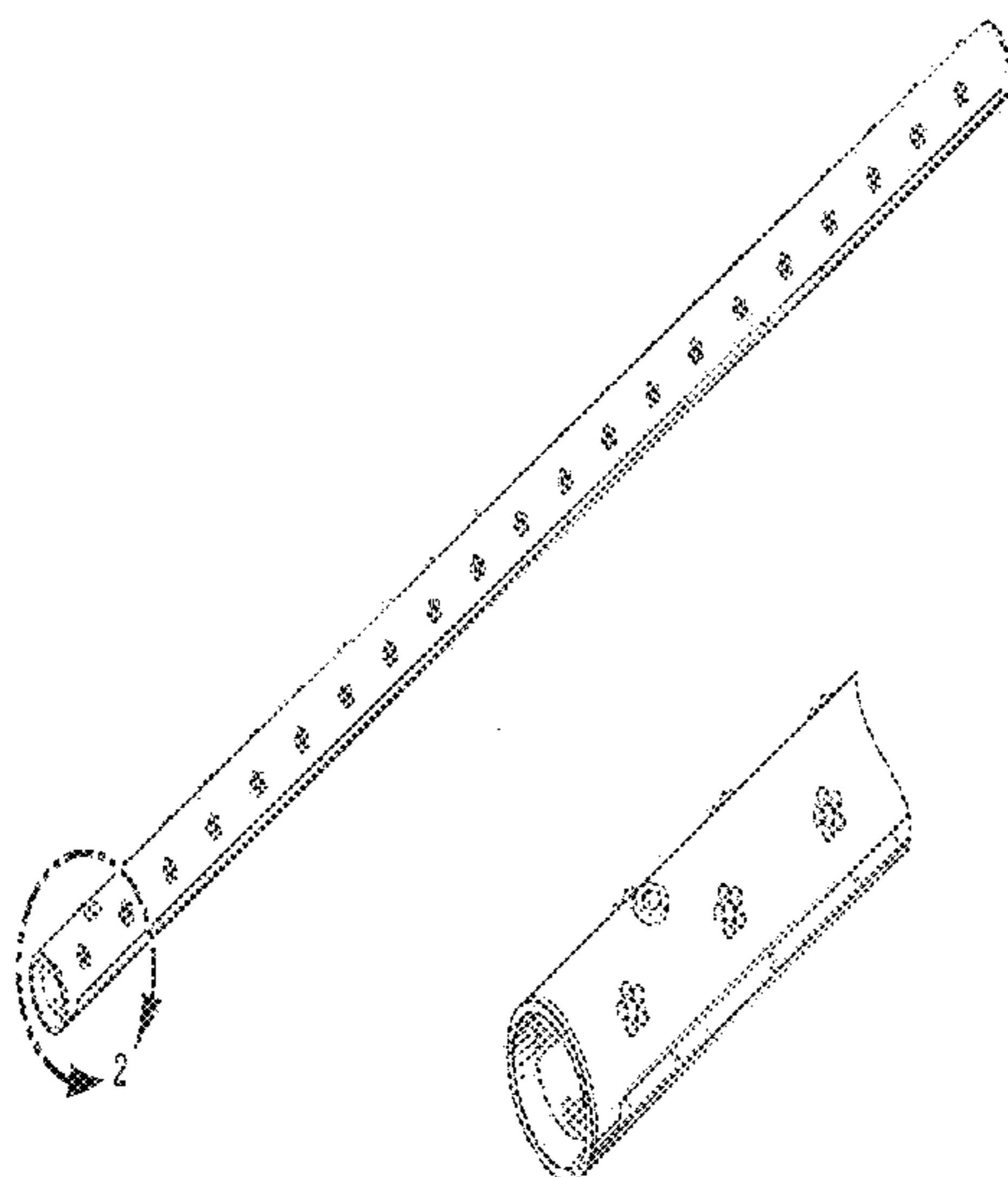

(56)

References Cited

U.S. PATENT DOCUMENTS

D359,338 S *	6/1995	Starrett	D22/117	D568,514 S *	5/2008	Shiu	D26/49
5,469,297 A *	11/1995	Marshall et al.	359/617	7,371,147 B2 *	5/2008	Tusacciu	446/85
5,487,691 A *	1/1996	Chiu	446/126	D573,861 S *	7/2008	Hammer et al.	D8/72
D371,214 S *	6/1996	Terry, Sr.	D26/49	D578,687 S *	10/2008	Hong	D26/37
D383,205 S *	9/1997	Pagay et al.	D24/112	7,465,293 B2 *	12/2008	Reinecke et al.	604/187
5,786,938 A *	7/1998	Chang	359/617	7,470,259 B2 *	12/2008	Hoyle, Jr.	604/207
5,924,382 A	7/1999	Shumaker		D588,756 S	3/2009	Colvin et al.	
D417,022 S *	11/1999	Chiu	D26/49	D593,801 S *	6/2009	Wilson et al.	D7/510
D420,157 S *	2/2000	Garrity et al.	D26/49	D599,877 S *	9/2009	Battin, Jr.	D22/147
D424,240 S *	5/2000	Ton	D28/37	D607,558 S *	1/2010	Abry et al.	D24/113
D427,387 S *	6/2000	Millet et al.	D30/124	D607,591 S *	1/2010	Rivera et al.	D26/49
D431,874 S *	10/2000	Burns	D26/49	D617,038 S *	6/2010	Feigenbaum	D26/93
D443,705 S *	6/2001	Sanders	D26/37	D618,855 S *	6/2010	Messina	D29/100
D459,840 S *	7/2002	Lian	D30/124	D623,310 S *	9/2010	Cheng	D24/211
D469,197 S *	1/2003	Robinson	D26/37	D630,292 S *	1/2011	Yang-Fu	D22/117
6,543,383 B1	4/2003	Cote		D643,561 S *	8/2011	Maglica	D26/49
6,672,789 B2 *	1/2004	Chen	403/171	D647,230 S *	10/2011	Bertken	D26/38
D505,755 S	5/2005	Lundstrom et al.		D647,995 S *	11/2011	Kowalski et al.	D22/147
D510,637 S *	10/2005	Chan	D26/49	D649,405 S *	11/2011	Lingo	D7/523
D520,593 S *	5/2006	Anderson	D22/117	D658,794 S *	5/2012	Wang	D26/38
D520,733 S *	5/2006	Siteman	D22/117	D662,402 S *	6/2012	Elkaim	D8/376
D532,859 S *	11/2006	Stethem	D22/117	D663,526 S *	7/2012	Wu et al.	D3/318
D538,485 S *	3/2007	Degironne	D30/124	D665,076 S *	8/2012	Sauer et al.	D24/133
D544,120 S *	6/2007	Matthews et al.	D26/37	D675,358 S *	1/2013	Brands et al.	D26/49
D548,761 S *	8/2007	Kung	D16/132	D676,170 S *	2/2013	Feng et al.	D26/38
D551,368 S *	9/2007	Shiu	D26/37	D677,534 S *	3/2013	Roggenbuck et al.	D8/1
D558,626 S *	1/2008	Chung	D10/105	D684,717 S *	6/2013	Hicks	D26/49
D560,012 S *	1/2008	Liu	D26/49	D690,383 S *	9/2013	Sheikh et al.	D22/117
D564,847 S *	3/2008	Hurlburt	D8/14	D692,600 S *	10/2013	Kamm	D26/49
D567,416 S *	4/2008	Shiu	D26/37	D698,056 S *	1/2014	Forbes et al.	D26/49
				D700,346 S *	2/2014	Palizzi et al.	D24/211
				2007/0117688 A1 *	5/2007	Sewitch et al.	482/83
				2011/0092129 A1 *	4/2011	Aggar et al.	446/85

* cited by examiner

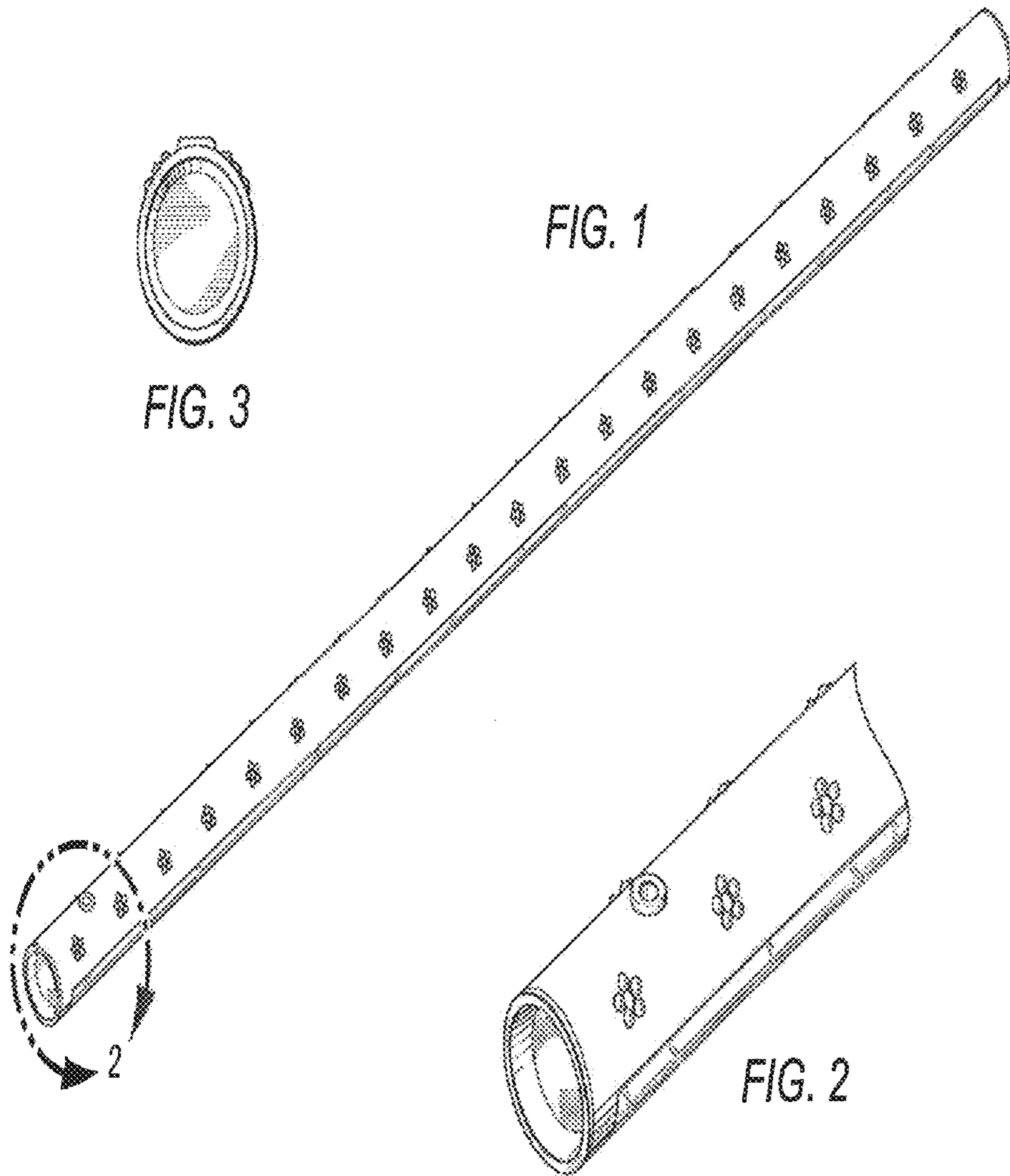

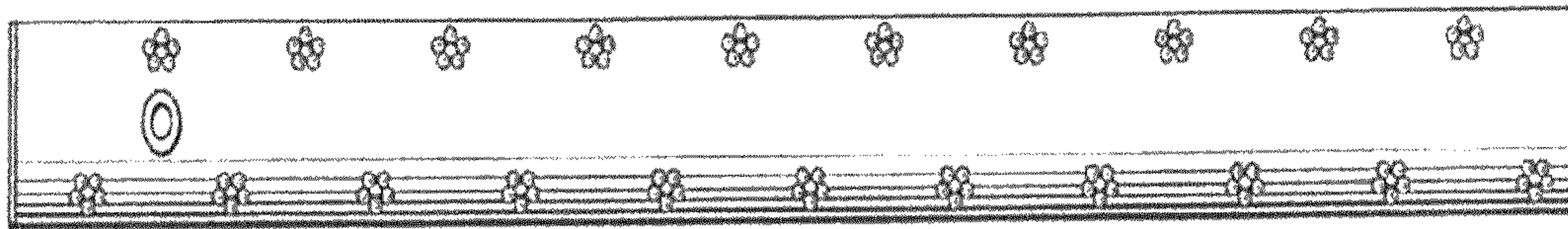

FIG. 4A

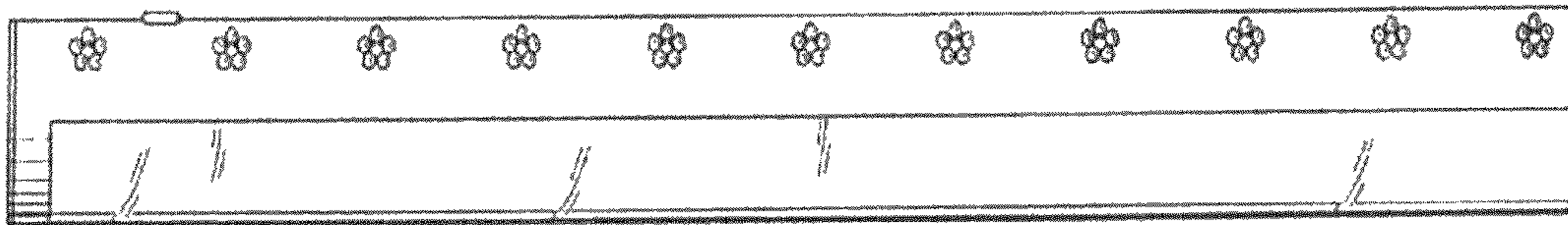

FIG. 5A

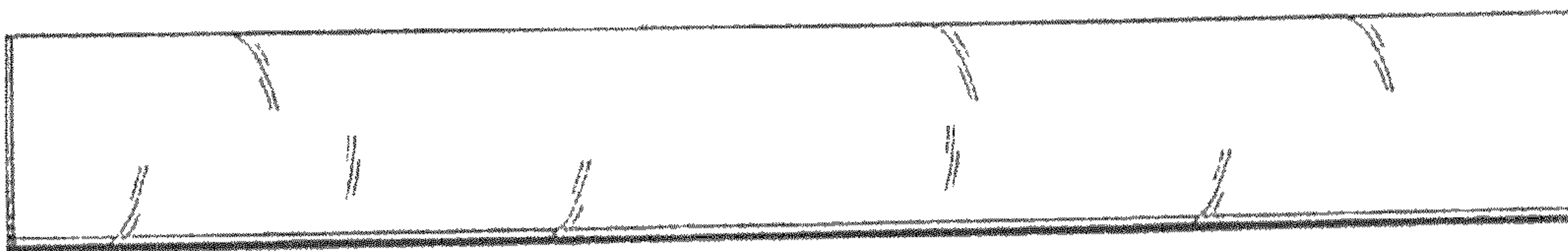

FIG. 6A

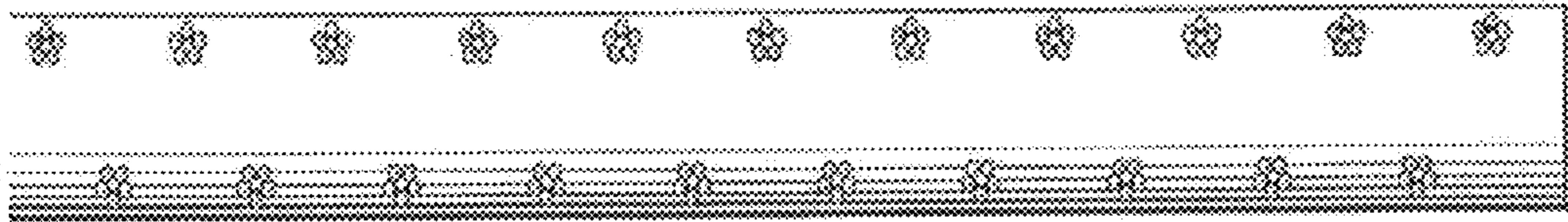

FIG. 4B

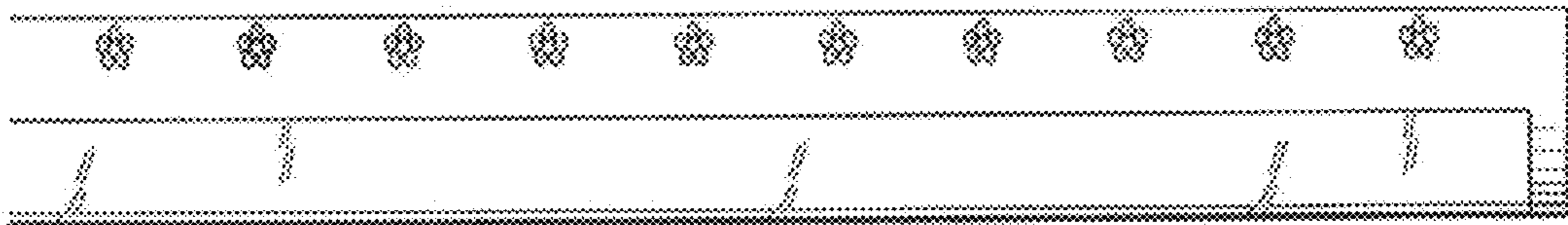

FIG. 5B

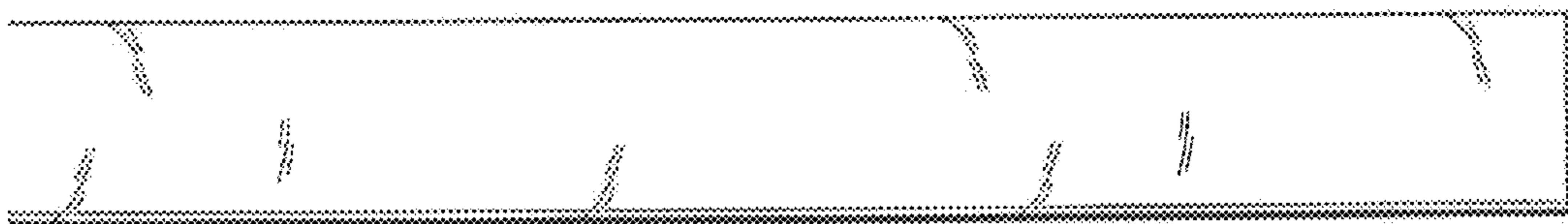

FIG. 6B