



US00D708379S

(12) **United States Design Patent**
Ruffalo et al.

(10) **Patent No.:** **US D708,379 S**
(45) **Date of Patent:** **** Jul. 1, 2014**

(54) **LIGHTING FIXTURE**

(71) Applicant: **Cree, Inc**, Durham, NC (US)

(72) Inventors: **Lisa Ruffalo**, Franksville, WI (US);
Alan J. Ruud, Racine, WI (US)

(73) Assignee: **Cree, Inc.**, Durham, NC (US)

(**) Term: **14 Years**

(21) Appl. No.: **29/434,452**

(22) Filed: **Oct. 12, 2012**

(51) **LOC (10) Cl.** **26-05**

(52) **U.S. Cl.**
USPC **D26/71**

(58) **Field of Classification Search**
USPC D26/63, 67-72, 92; 362/183, 294, 373,
362/431
See application file for complete search history.

(56) **References Cited**

U.S. PATENT DOCUMENTS

D541,463 S	4/2007	Tortel	
D572,857 S	7/2008	Kauffman et al.	
7,420,811 B2 *	9/2008	Chan	361/709
D578,697 S *	10/2008	Zheng et al.	D26/71
D600,846 S	9/2009	Hsu et al.	
D601,292 S *	9/2009	Yan et al.	D26/71
D605,328 S *	12/2009	Wang et al.	D26/71
D608,927 S	1/2010	Hsu et al.	
D609,383 S	2/2010	Chang	

(Continued)

OTHER PUBLICATIONS

Light Fixture shown in May 2010.

Primary Examiner — Clare E Heflin

(74) *Attorney, Agent, or Firm* — Jansson Munger McKinley & Shape Ltd.

(57) **CLAIM**

The ornamental design for a lighting fixture, as shown and described.

DESCRIPTION

FIG. 1 is a perspective view of the lighting fixture;
 FIG. 2 is a right-side elevation of the lighting fixture of FIG. 1;
 FIG. 3 is a left-side elevation of the lighting fixture of FIG. 1;
 FIG. 4 is a bottom plan view of the lighting fixture of FIG. 1;
 FIG. 5 is a top plan view of the lighting fixture of FIG. 1;
 FIG. 6 is a front elevation of the lighting fixture of FIG. 1;
 FIG. 7 is a rear elevation of the lighting fixture of FIG. 1;
 FIG. 8 is a perspective view of a second embodiment of the lighting-fixture design, the primary difference being a pole fitter shown in phantom lines;
 FIG. 9 is a right-side elevation of the lighting fixture of FIG. 8;
 FIG. 10 is a left-side elevation of the lighting fixture of FIG. 8;
 FIG. 11 is a bottom plan view of the lighting fixture of FIG. 8;
 FIG. 12 is another bottom plan view of the lighting fixture of FIG. 8 showing the light fixture without the pole fitter;
 FIG. 13 is a top plan view of the lighting fixture of FIG. 8;
 FIG. 14 is a front elevation of the lighting fixture of FIG. 8;
 FIG. 15 is a rear elevation of the lighting fixture of FIG. 8;
 and,
 FIG. 16 is another rear elevation of the lighting fixture of FIG. 8 showing the light fixture without the pole fitter.
 The phantom lines are provided for illustrative purposes only and form no part of the claimed design.

1 Claim, 14 Drawing Sheets

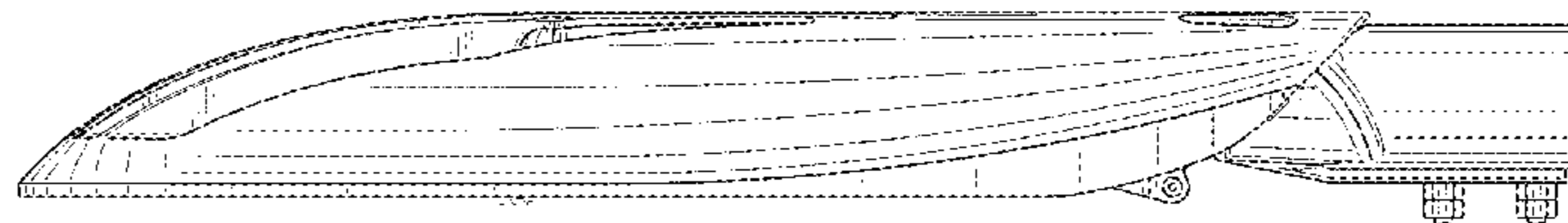
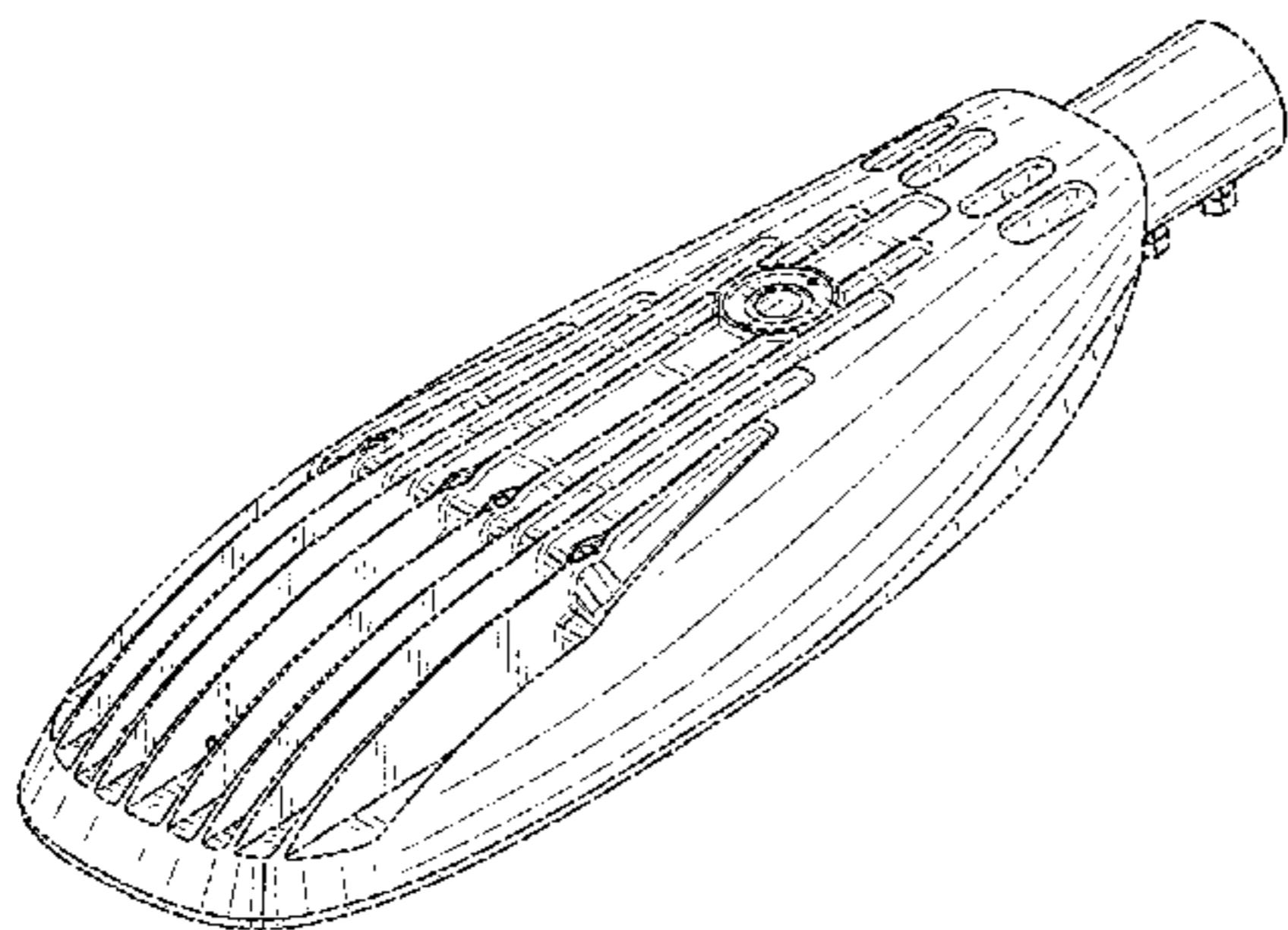

(56)

References Cited

U.S. PATENT DOCUMENTS

D615,234 S	5/2010	Oblak	
D622,433 S	8/2010	Waters	
D622,889 S	8/2010	Zheng	
D631,181 S	1/2011	Laporte et al.	
D631,591 S *	1/2011	Tortel	D26/71
D636,518 S	4/2011	Nevins	
D641,094 S	7/2011	Chang	
D642,724 S *	8/2011	Galipeau et al.	D26/71
D646,419 S	10/2011	Chiang et al.	
D647,237 S	10/2011	Su	
D647,238 S	10/2011	Su	
D660,493 S	5/2012	Janssen et al.	
D660,495 S *	5/2012	Walker et al.	D26/71
D663,462 S *	7/2012	Butler et al.	D26/71
8,210,706 B2 *	7/2012	Rooymans et al.	362/153.1
D665,940 S	8/2012	Lane et al.	
D666,759 S *	9/2012	Lane et al.	D26/71
8,382,387 B1 *	2/2013	Sandoval	396/427
D681,250 S *	4/2013	Ruffalo et al.	D26/71
D683,878 S *	6/2013	Ruffalo et al.	D26/71
2004/0196653 A1	10/2004	Clark et al.	
2009/0310381 A1	12/2009	Chang et al.	

* cited by examiner

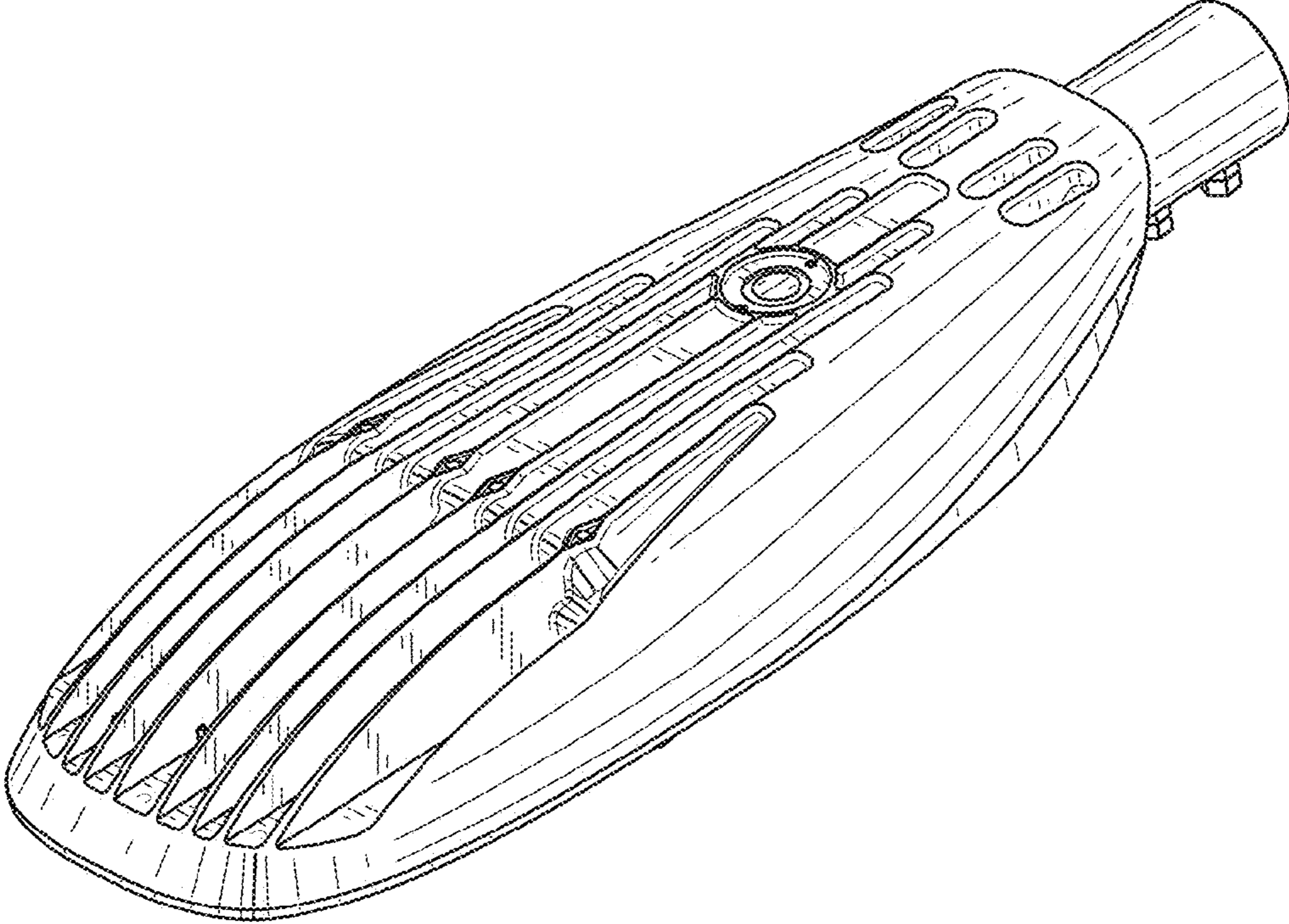

FIG. 1

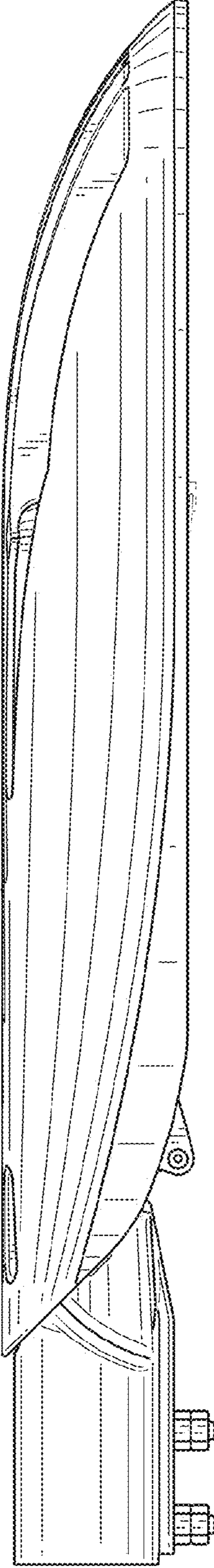

FIG. 2

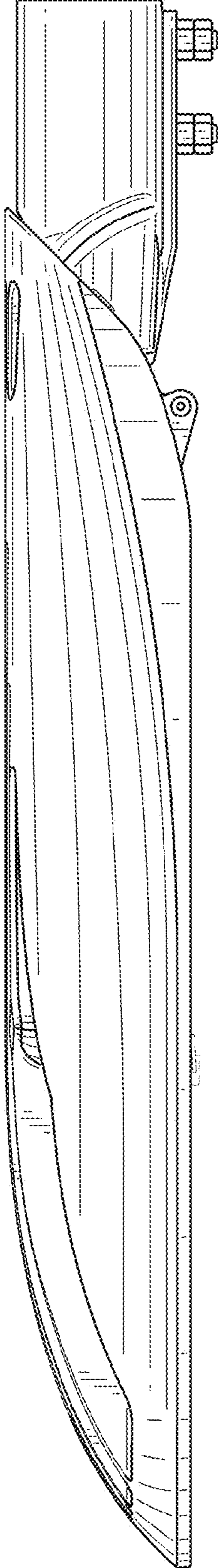

FIG. 3

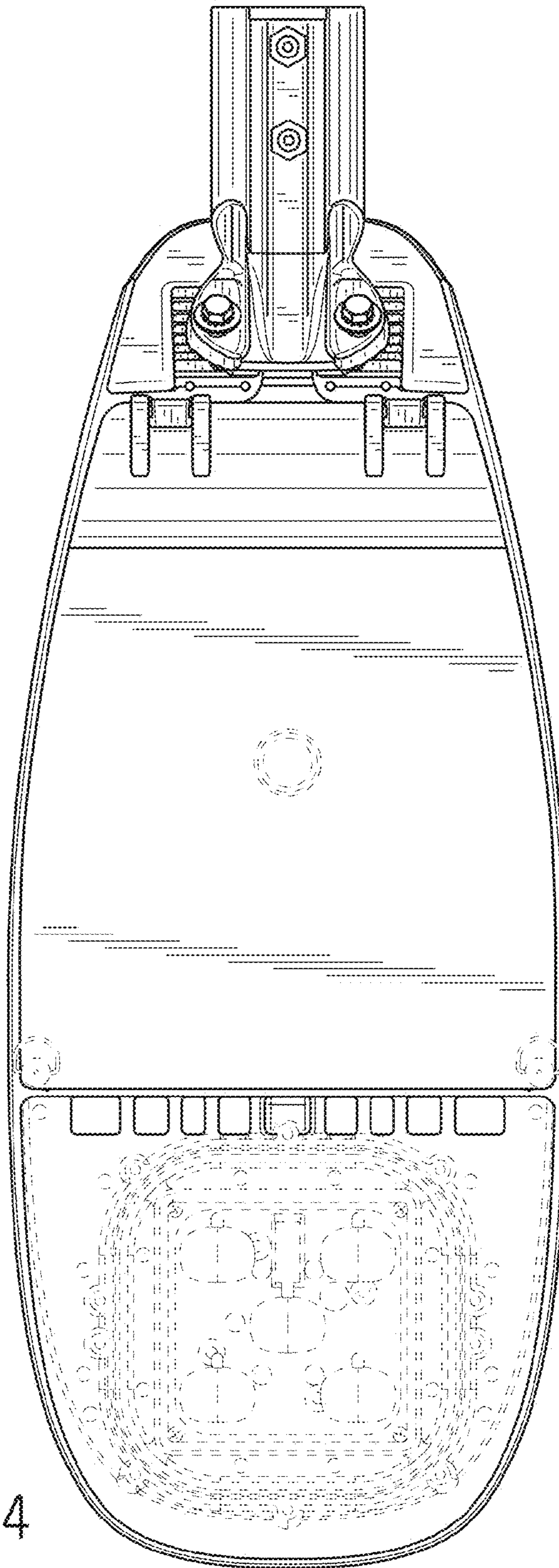

FIG. 4

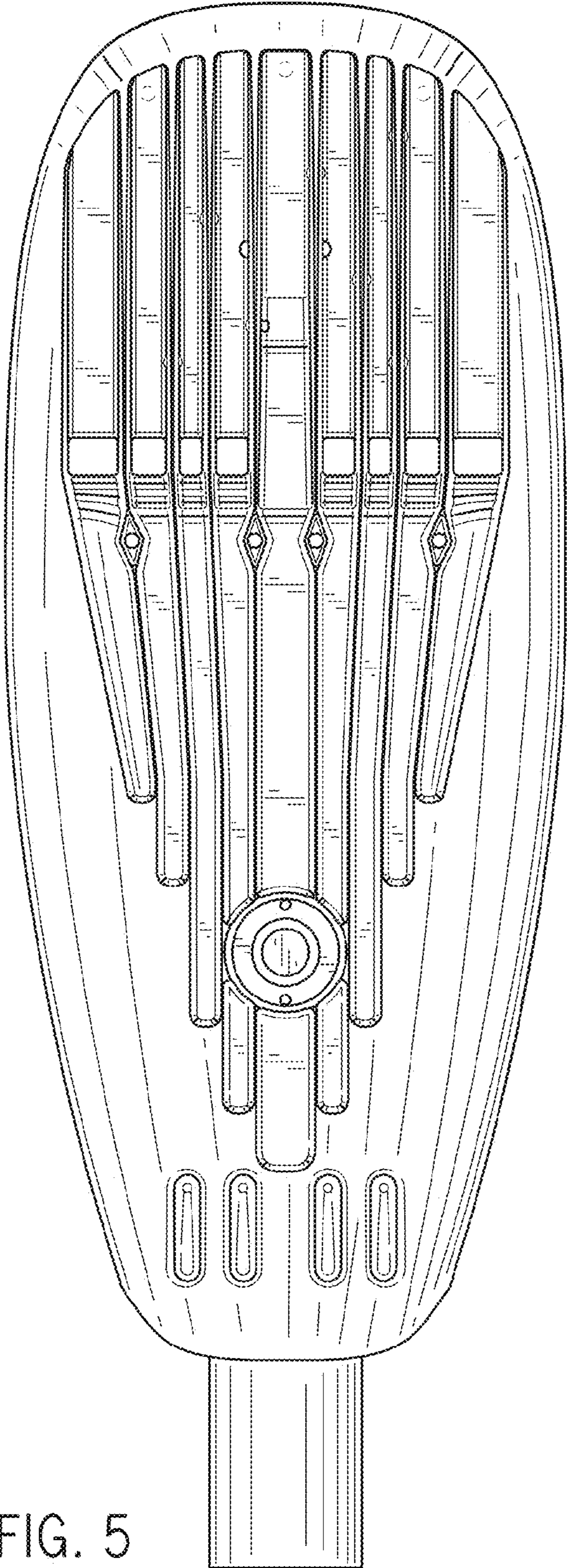

FIG. 5

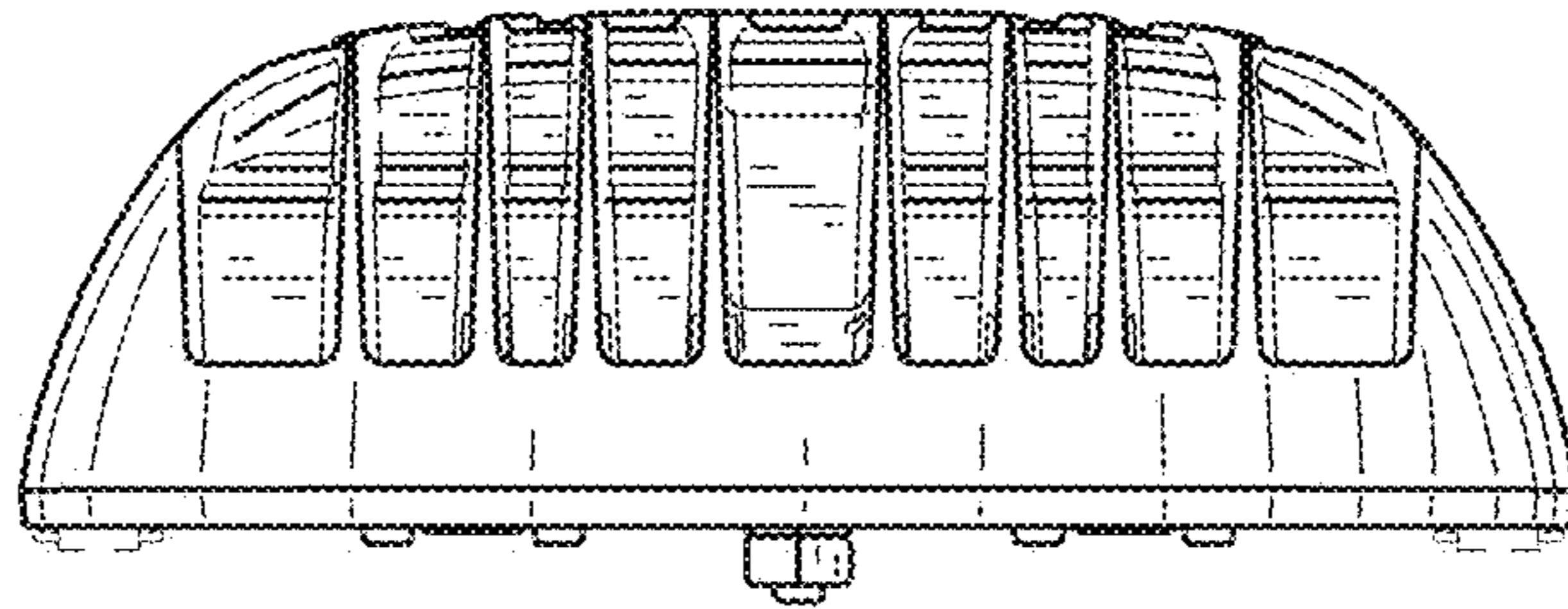

FIG. 6

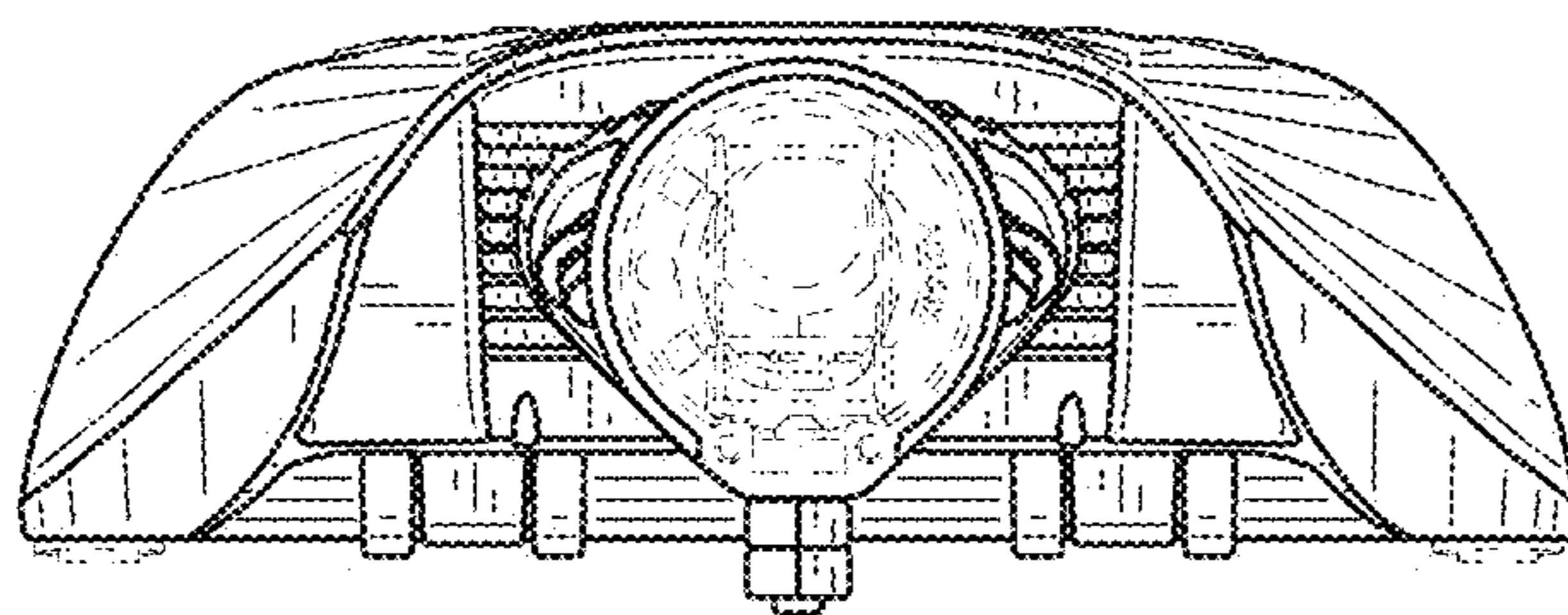

FIG. 7

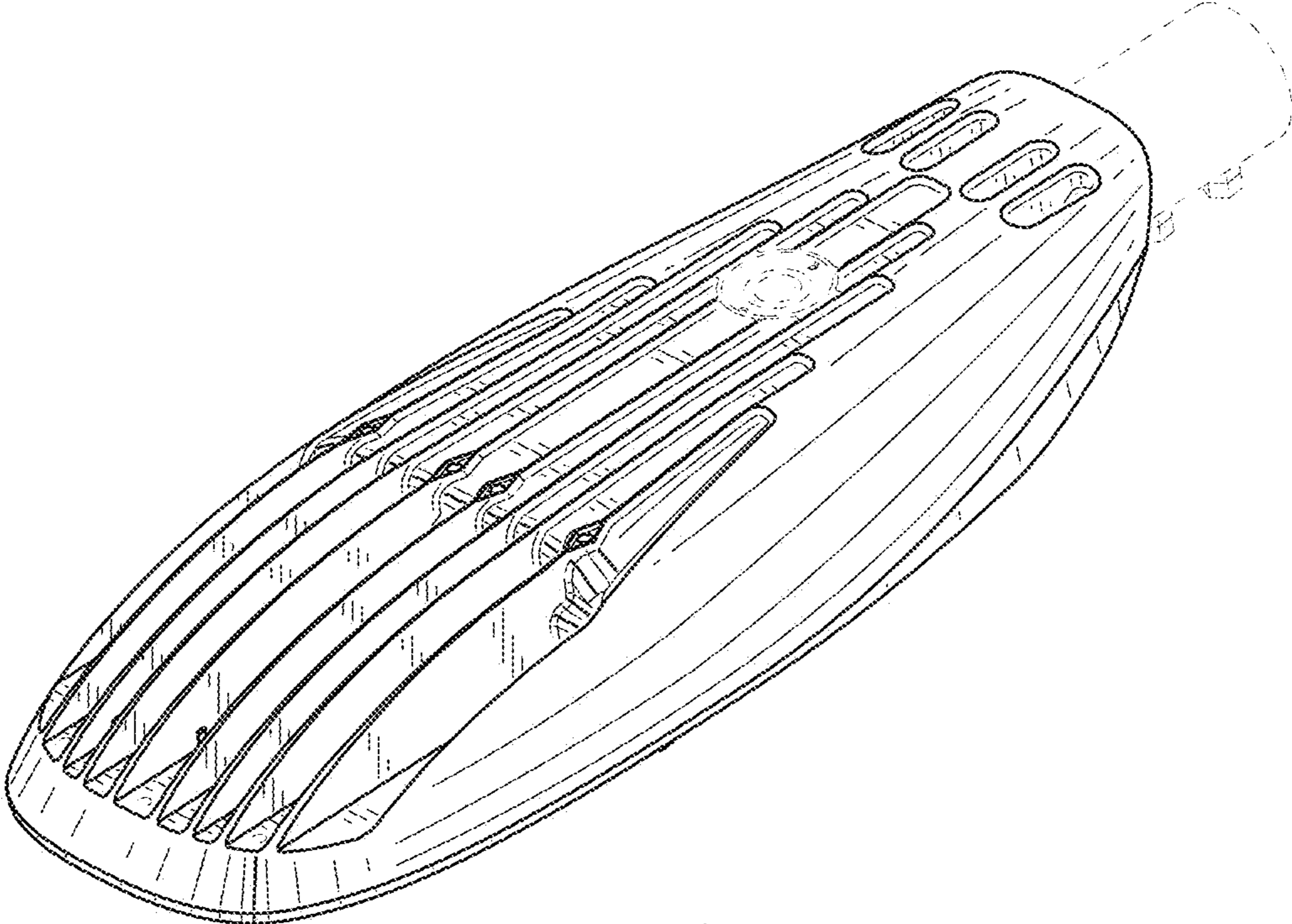

FIG. 8

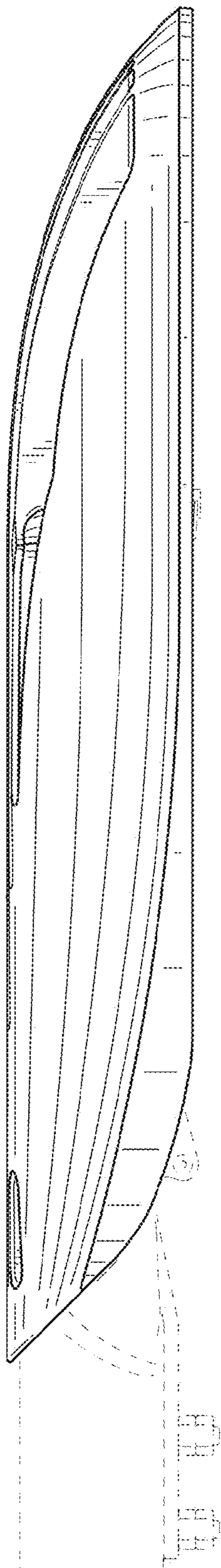

FIG. 9

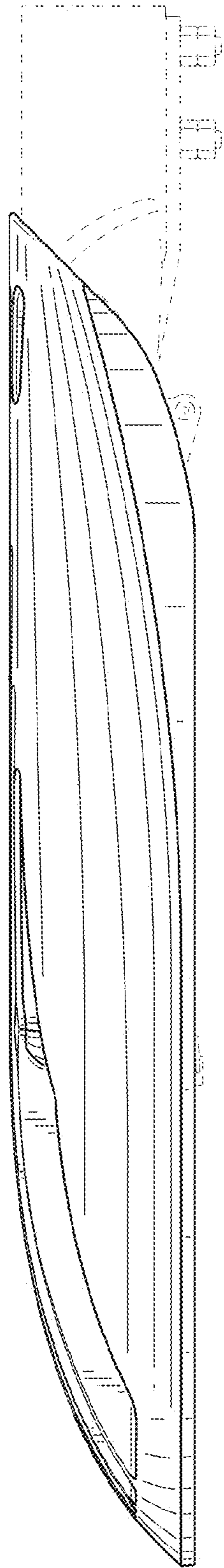

FIG. 10

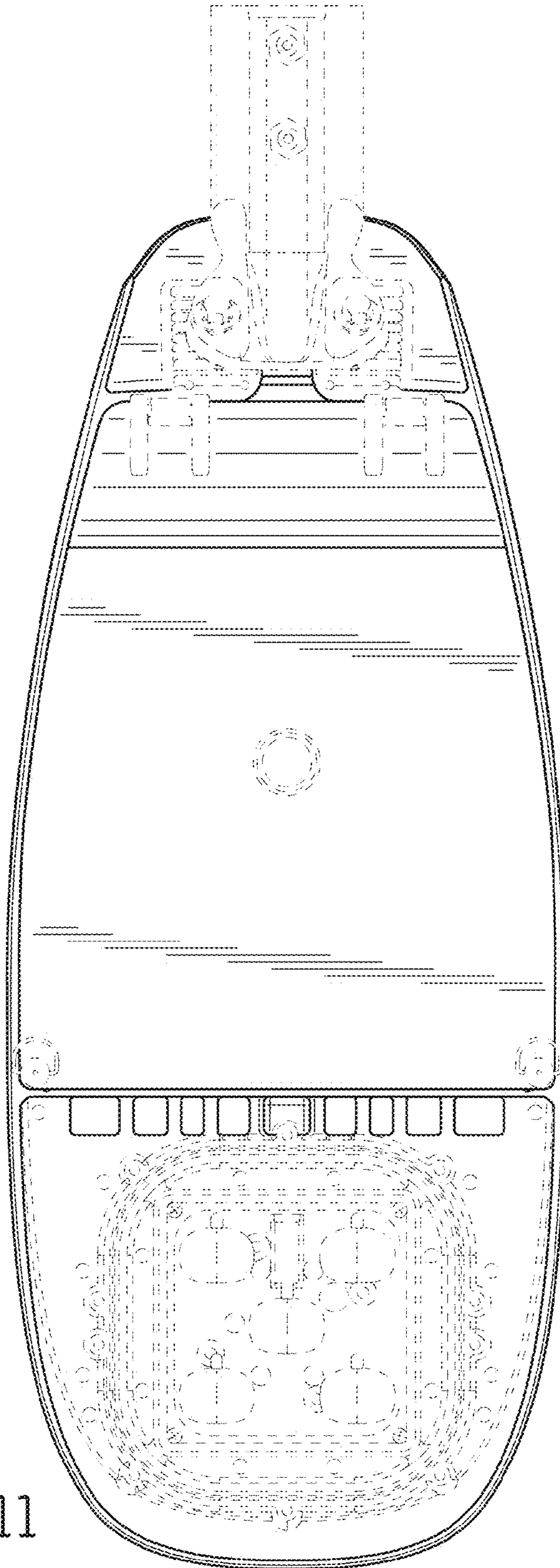

FIG. 11

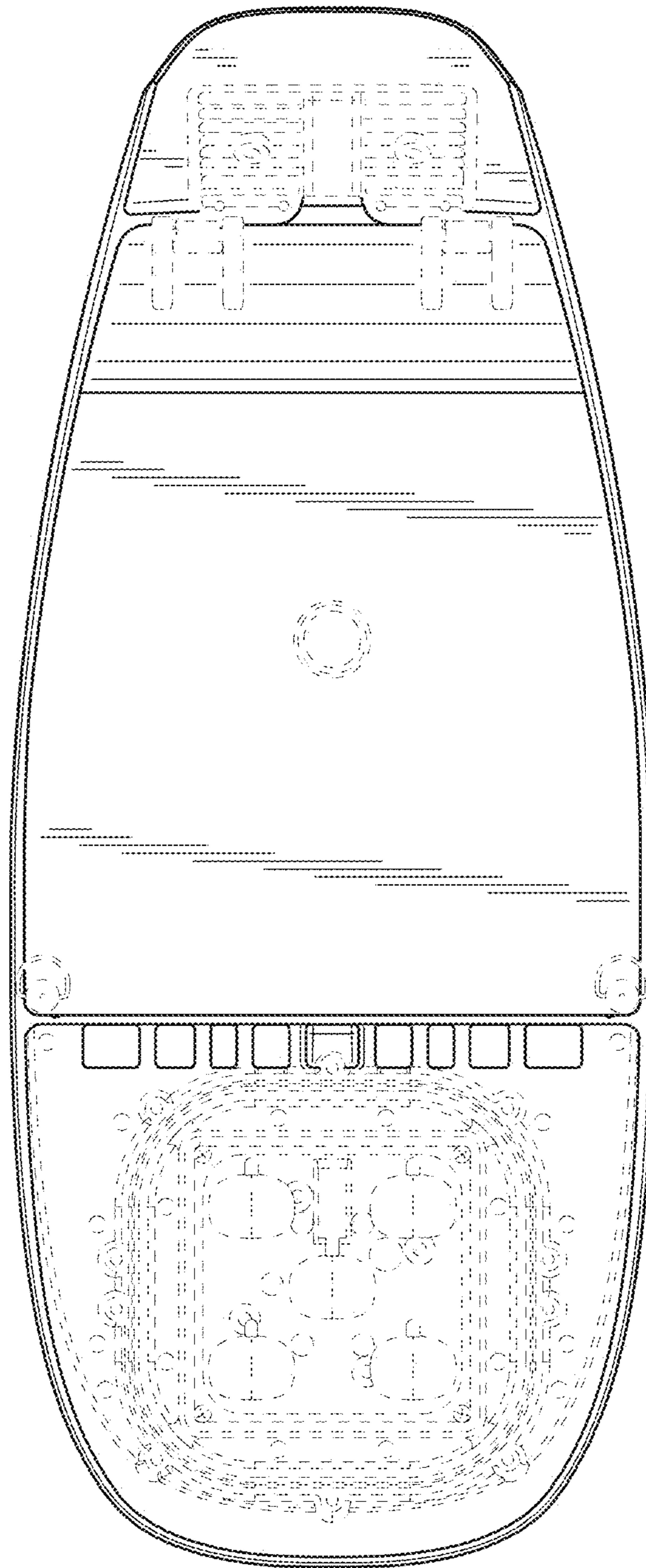

FIG. 12

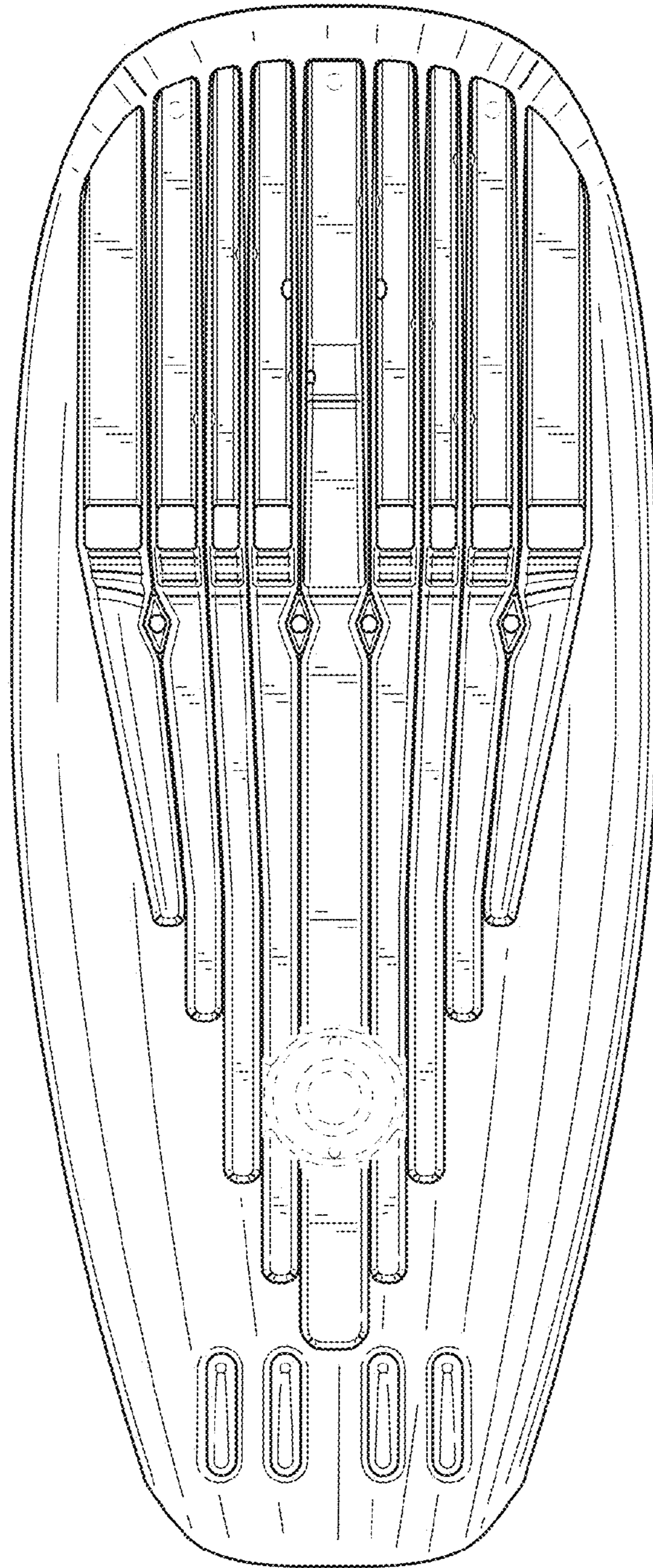

FIG. 13

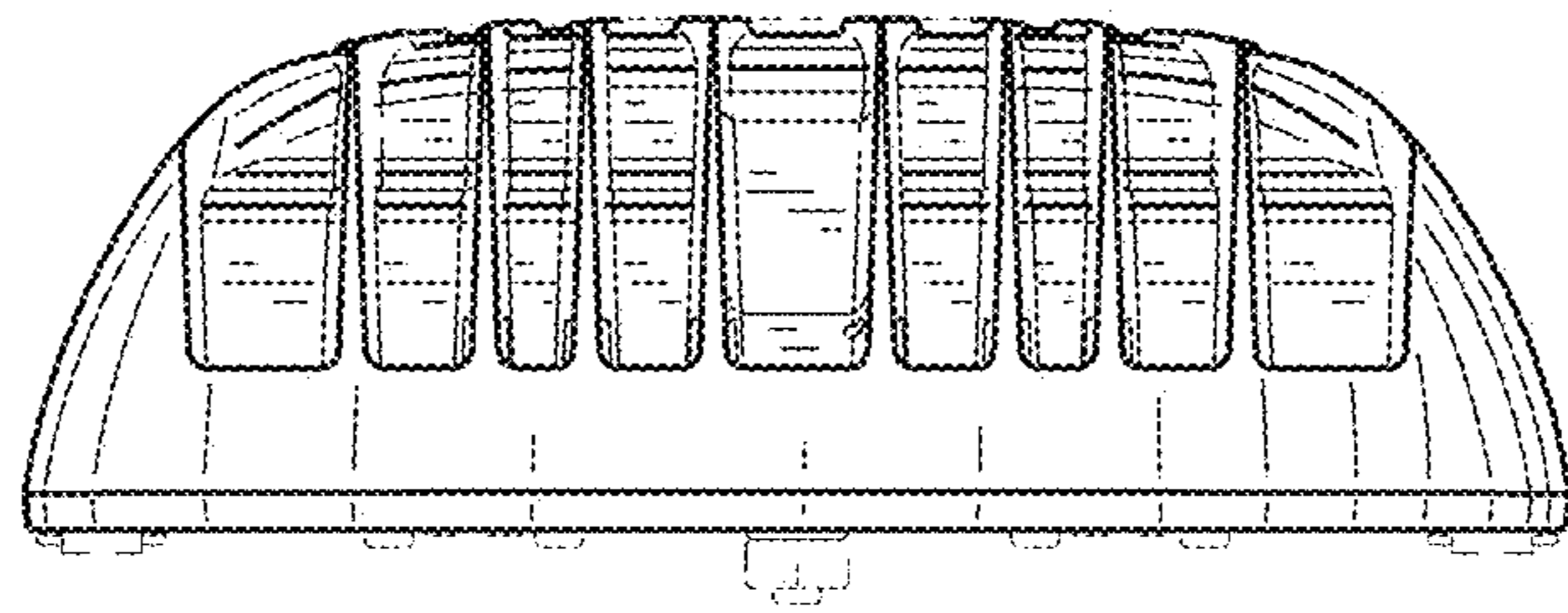

FIG. 14

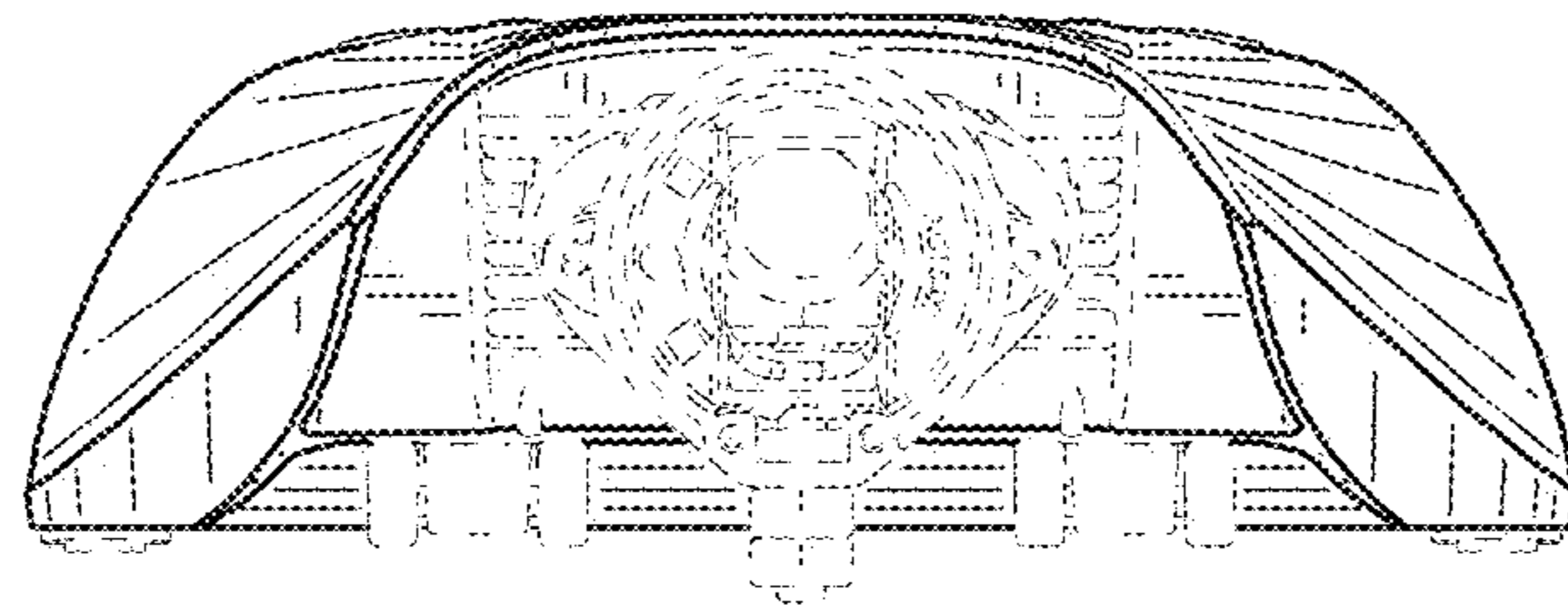

FIG. 15

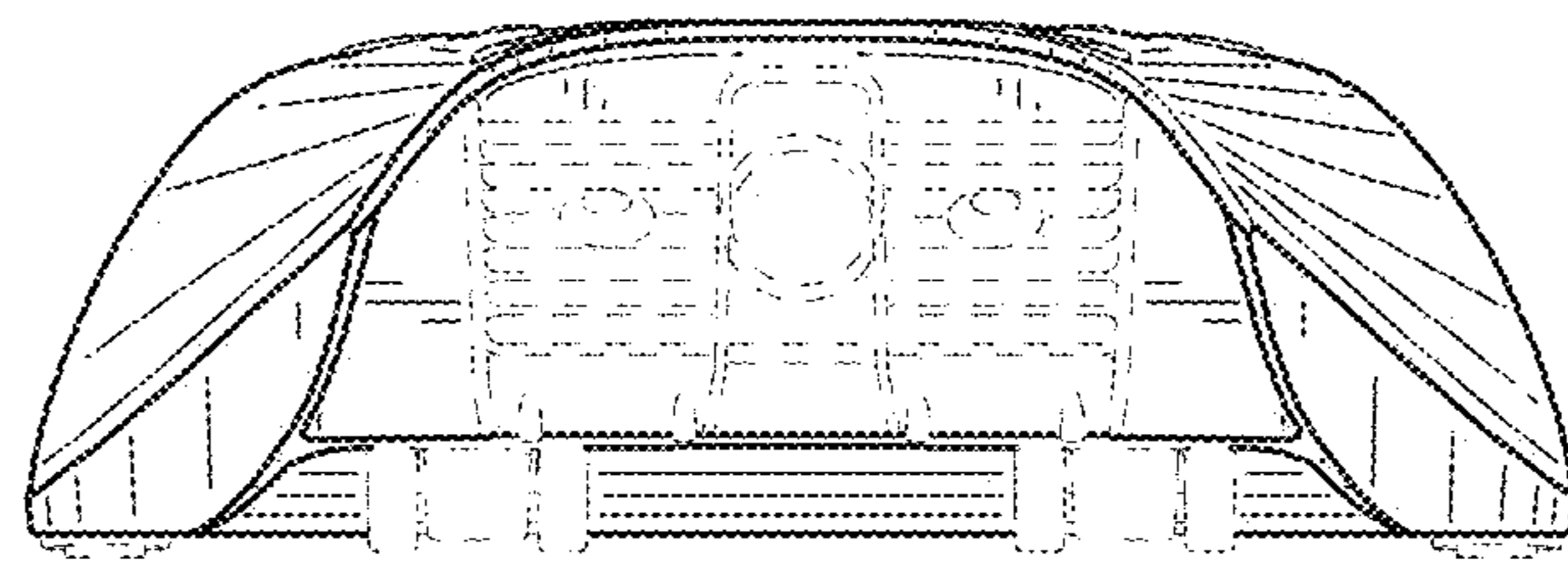

FIG. 16