



US00D708145S

(12) **United States Design Patent**
McCartin et al.

(10) **Patent No.:** **US D708,145 S**

(45) **Date of Patent:** **** Jul. 1, 2014**

(54) **CONNECTOR**

(71) Applicant: **Samtec, Inc.**, New Albany, IN (US)

(72) Inventors: **Douglas Edward McCartin**, Henryville, IN (US); **James Edward Borgelt**, Jeffersonville, IN (US); **Dale Francis Schmelz**, Depauw, IN (US); **Joseph Travis Newton**, Shelbyville, KY (US); **Chunhsien Hsu**, Taipei (TW)

(73) Assignee: **Samtec, Inc.**, New Albany, IN (US)

(**) Term: **14 Years**

(21) Appl. No.: **29/478,997**

(22) Filed: **Jan. 10, 2014**

(51) **LOC (10) Cl.** **13-03**

(52) **U.S. Cl.**
USPC **D13/147**

(58) **Field of Classification Search**
USPC D13/147, 154, 184, 199; 439/79, 108, 439/135, 180, 246, 278, 291, 328, 344, 350, 439/353, 357, 358, 374, 378, 381, 391, 489, 439/509, 527, 529, 530, 533, 587, 594, 598, 439/607.01, 607.04, 607.05, 607.17, 439/607.25, 607.34, 607.41, 607.53, 626, 439/629, 637, 656, 660, 668, 676, 680, 711, 439/745, 752, 892, 894

See application file for complete search history.

(56) **References Cited**

U.S. PATENT DOCUMENTS

D205,509	S	*	8/1966	Reynolds	D13/147
4,984,998	A	*	1/1991	Duncan et al.	439/352
D327,469	S	*	6/1992	Moriai et al.	D13/147
D335,649	S	*	5/1993	Ogawa	D13/147
D459,704	S	*	7/2002	Chen	D13/147
D463,370	S	*	9/2002	Chen	D13/147
D502,922	S	*	3/2005	Cheng et al.	D13/147
D523,399	S	*	6/2006	Sakamaki et al.	D13/147
D605,133	S	*	12/2009	Tanaka et al.	D13/147
D639,746	S	*	6/2011	Lee et al.	D13/147

* cited by examiner

Primary Examiner — Daniel Bui

(74) *Attorney, Agent, or Firm* — Keating & Bennett, LLP

(57) **CLAIM**

The ornamental design for a connector, as shown and described.

DESCRIPTION

FIG. 1 is a top, front, and right perspective view of a connector showing our new design;
FIG. 2 is a bottom, back, and right perspective view thereof;
FIG. 3 is a front view thereof;
FIG. 4 is a back view thereof;
FIG. 5 is a top view thereof;
FIG. 6 is a bottom view thereof;
FIG. 7 is a right view thereof; and,
FIG. 8 is a left view thereof.
Broken lines in the drawing views are included to show unclaimed subject matter only and form no part of the claimed design.

1 Claim, 4 Drawing Sheets

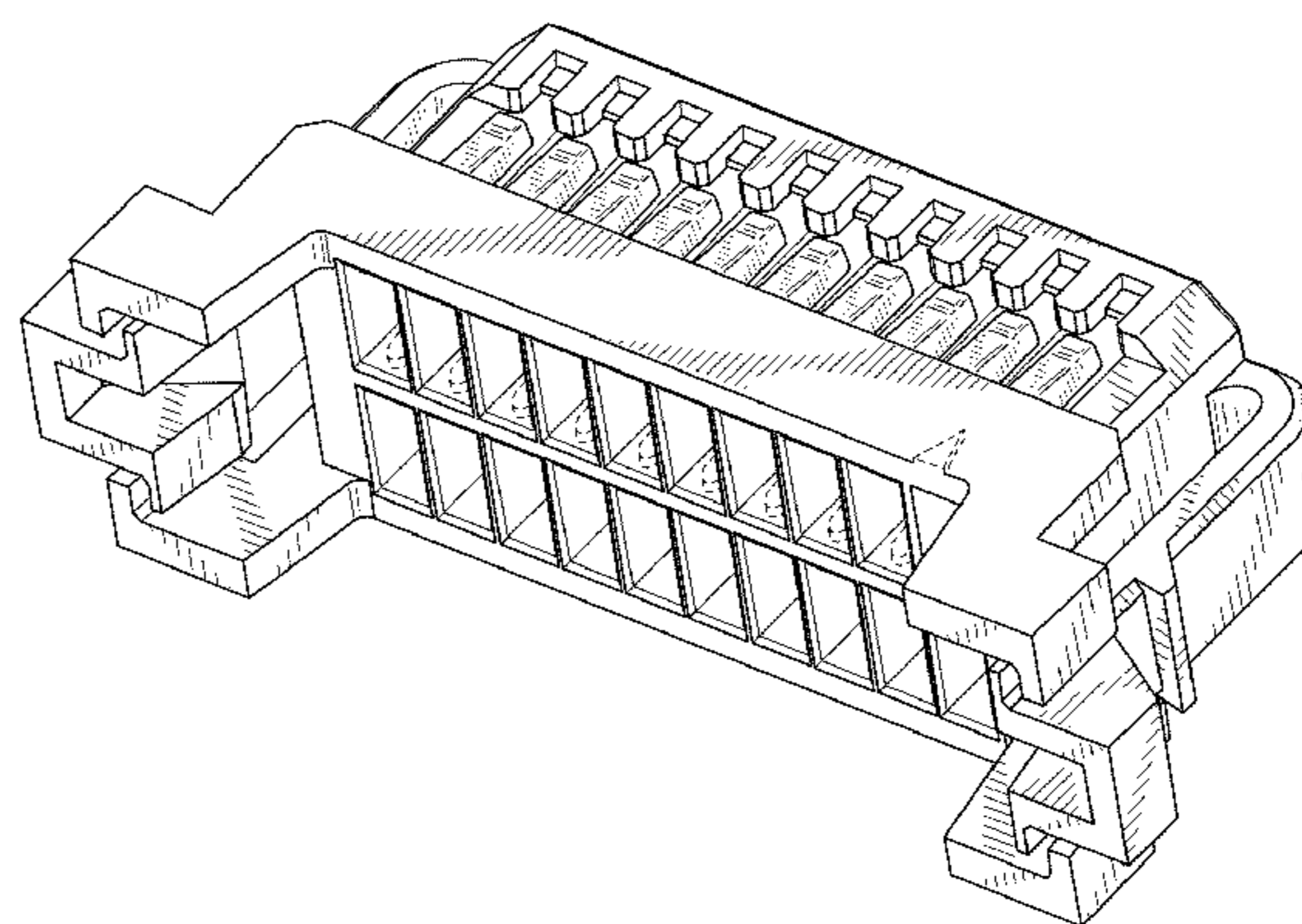
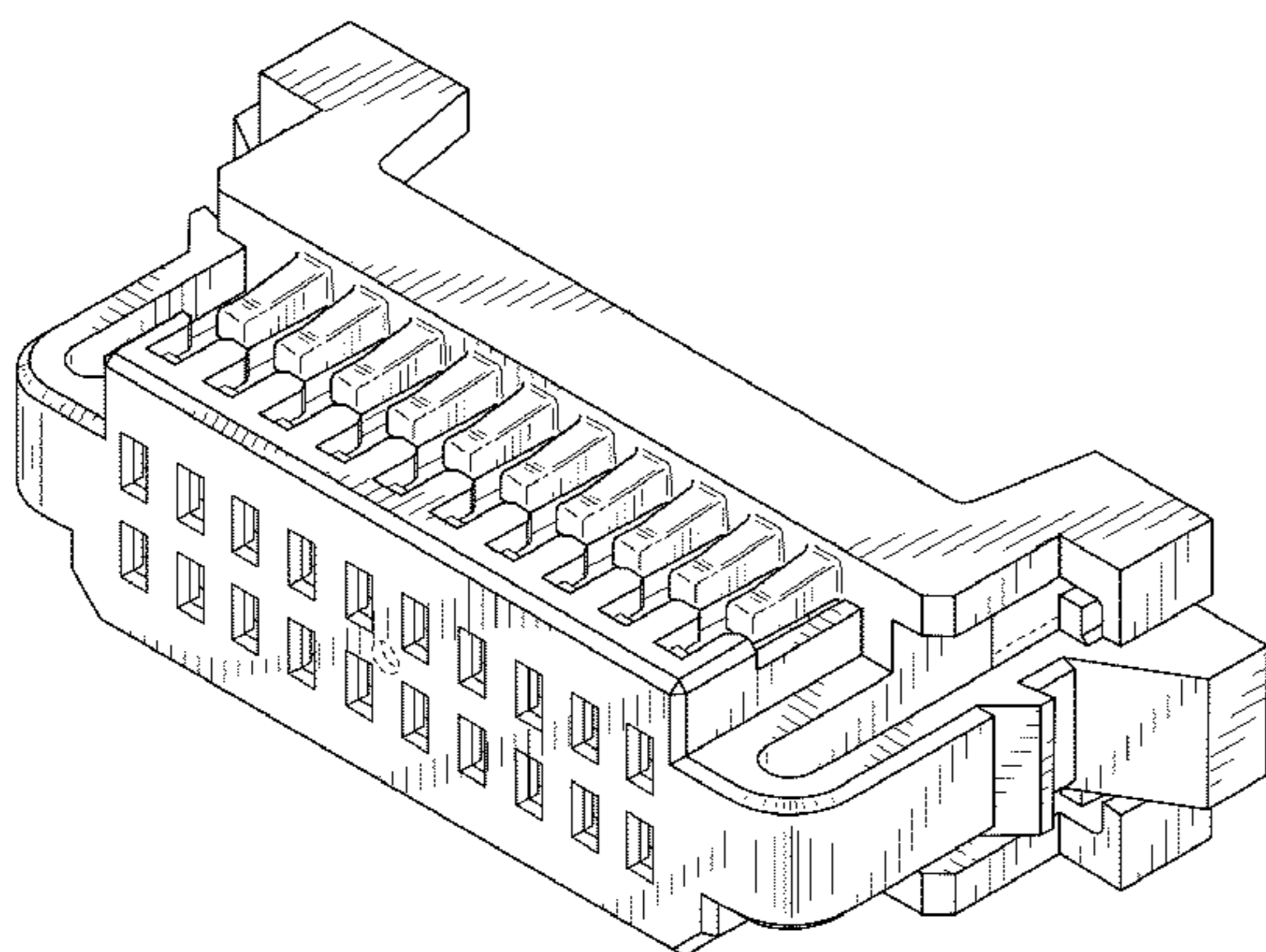

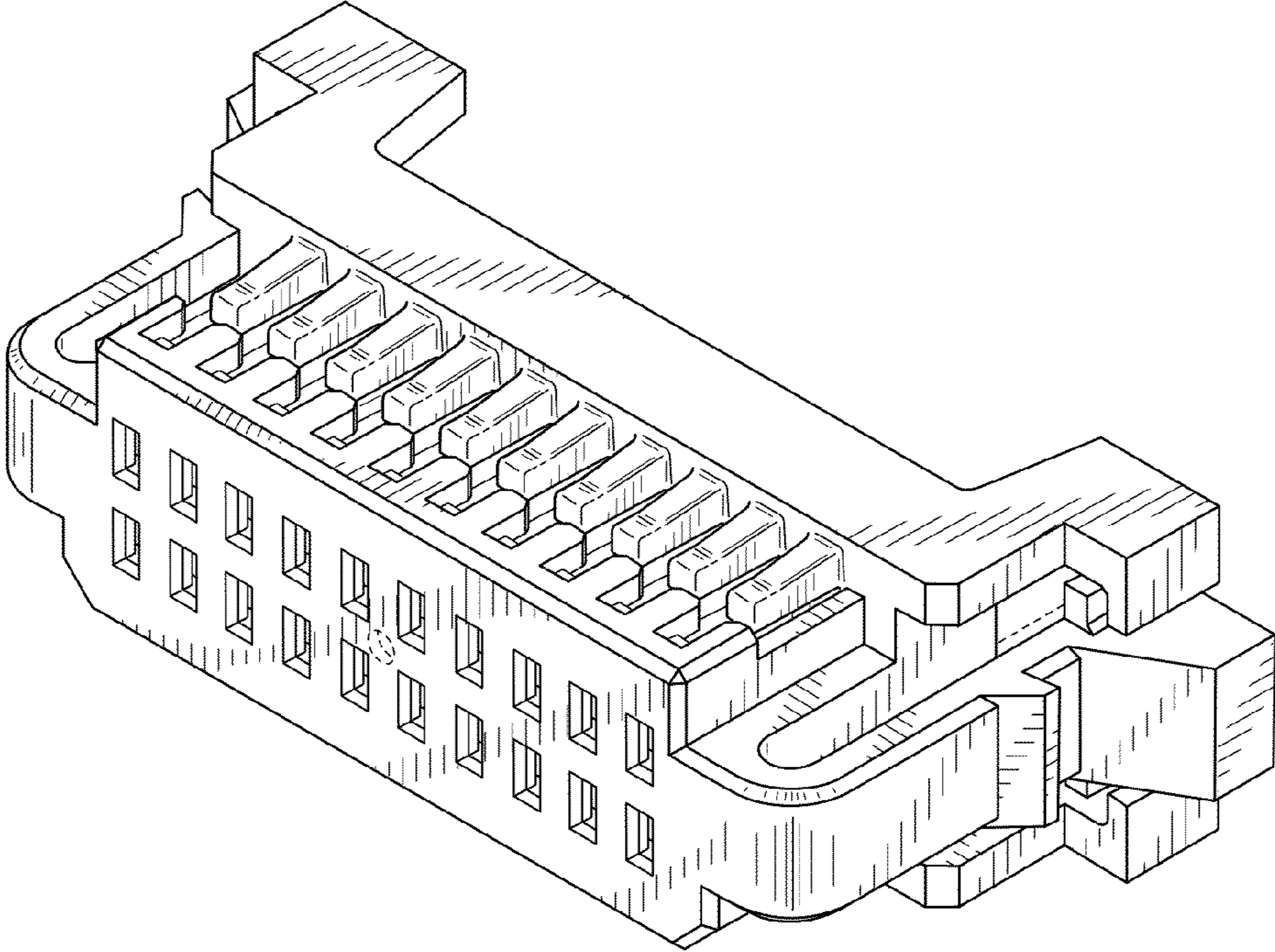

FIG. 1

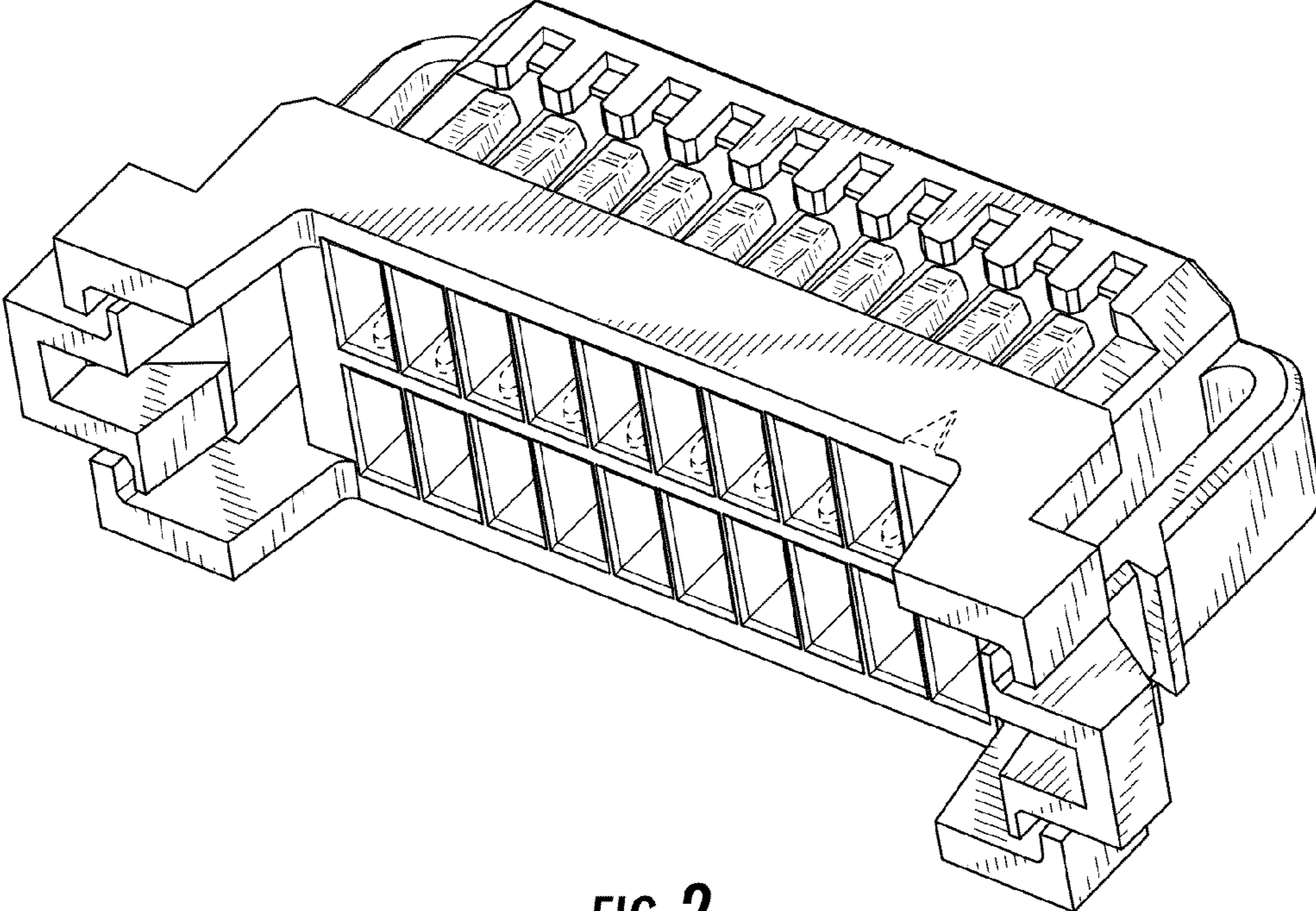

FIG. 2

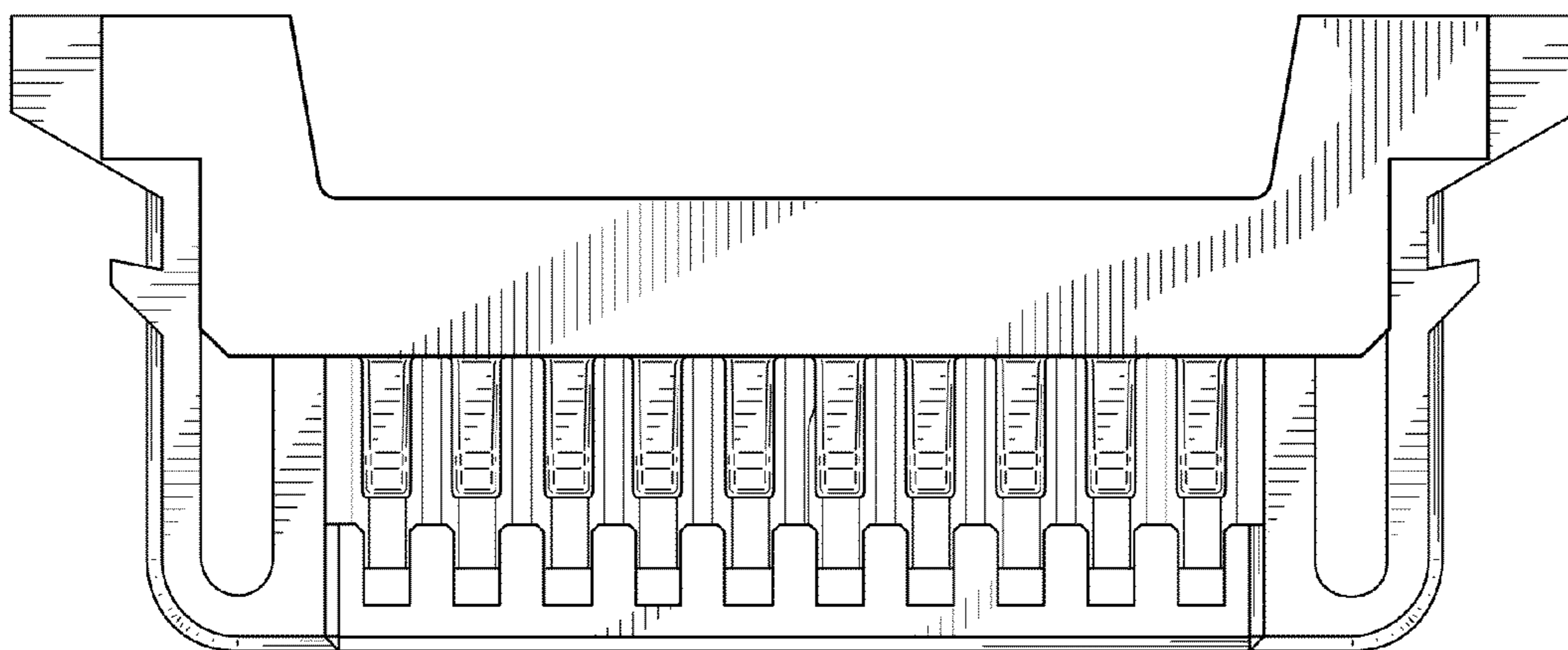

FIG. 3

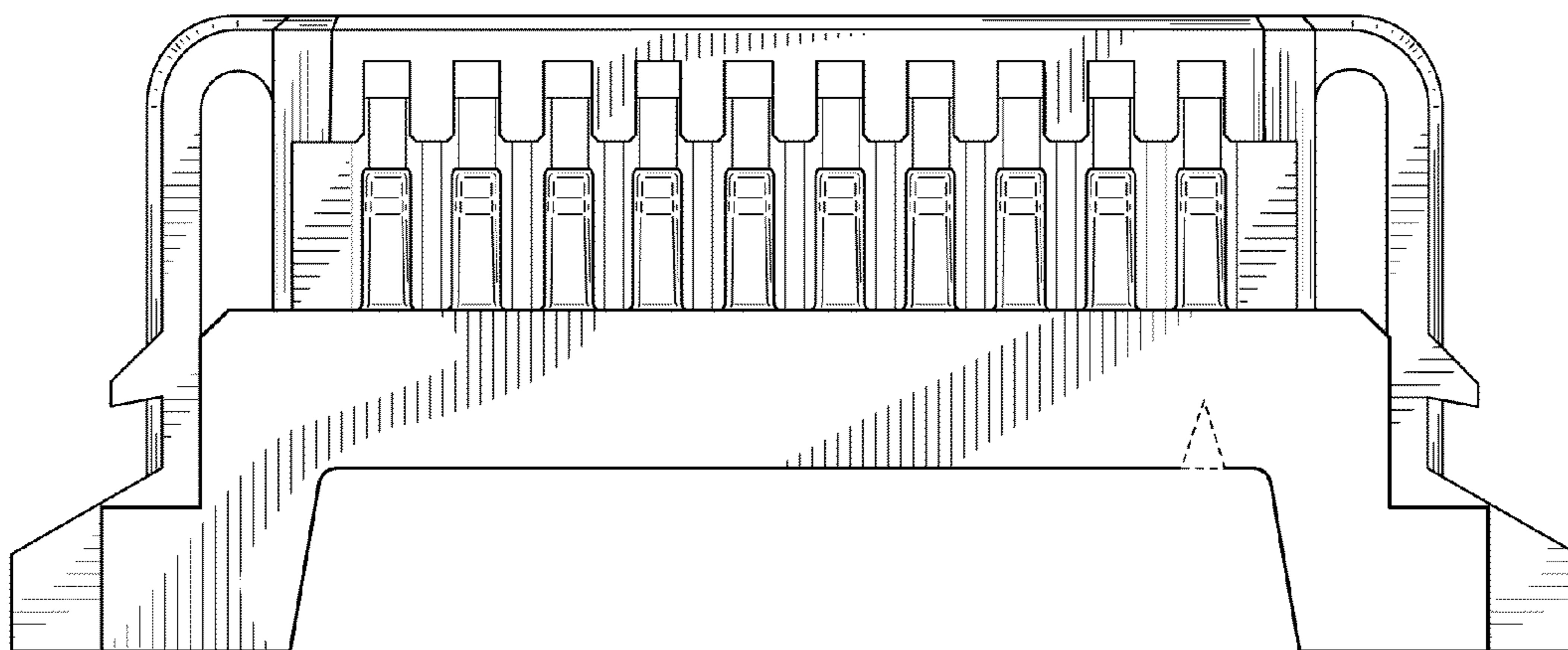

FIG. 4

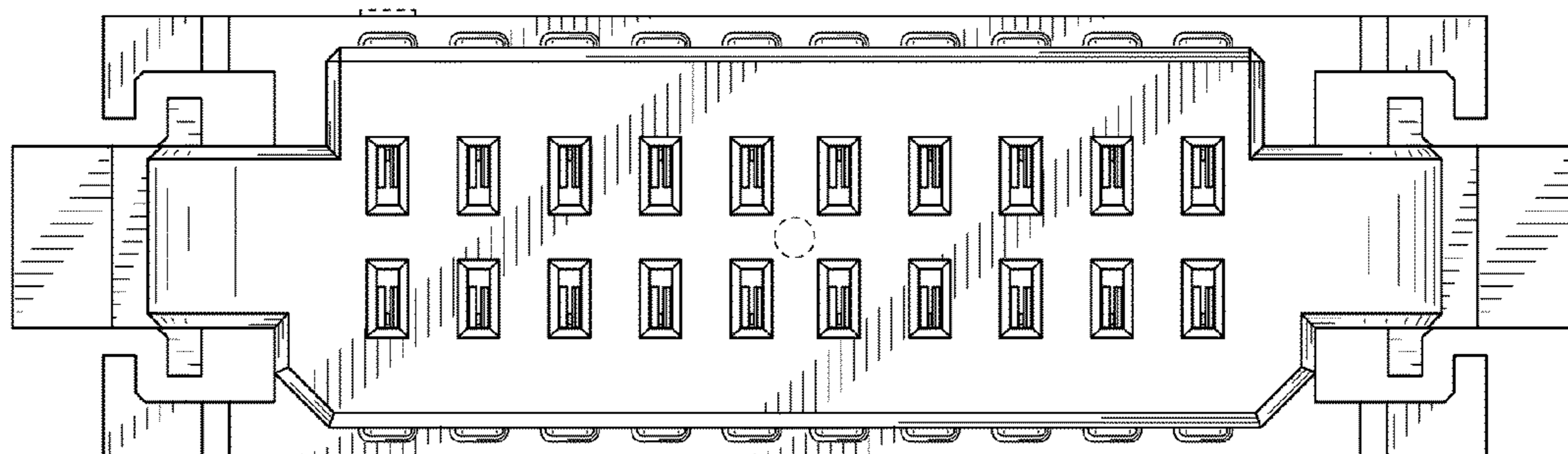

FIG. 5

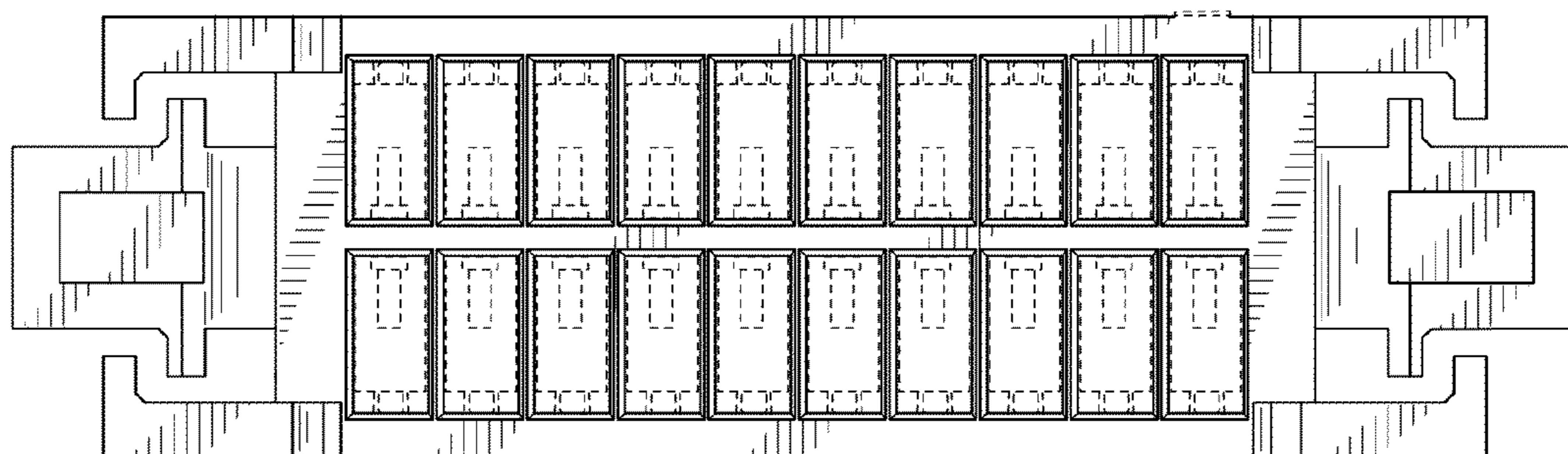

FIG. 6

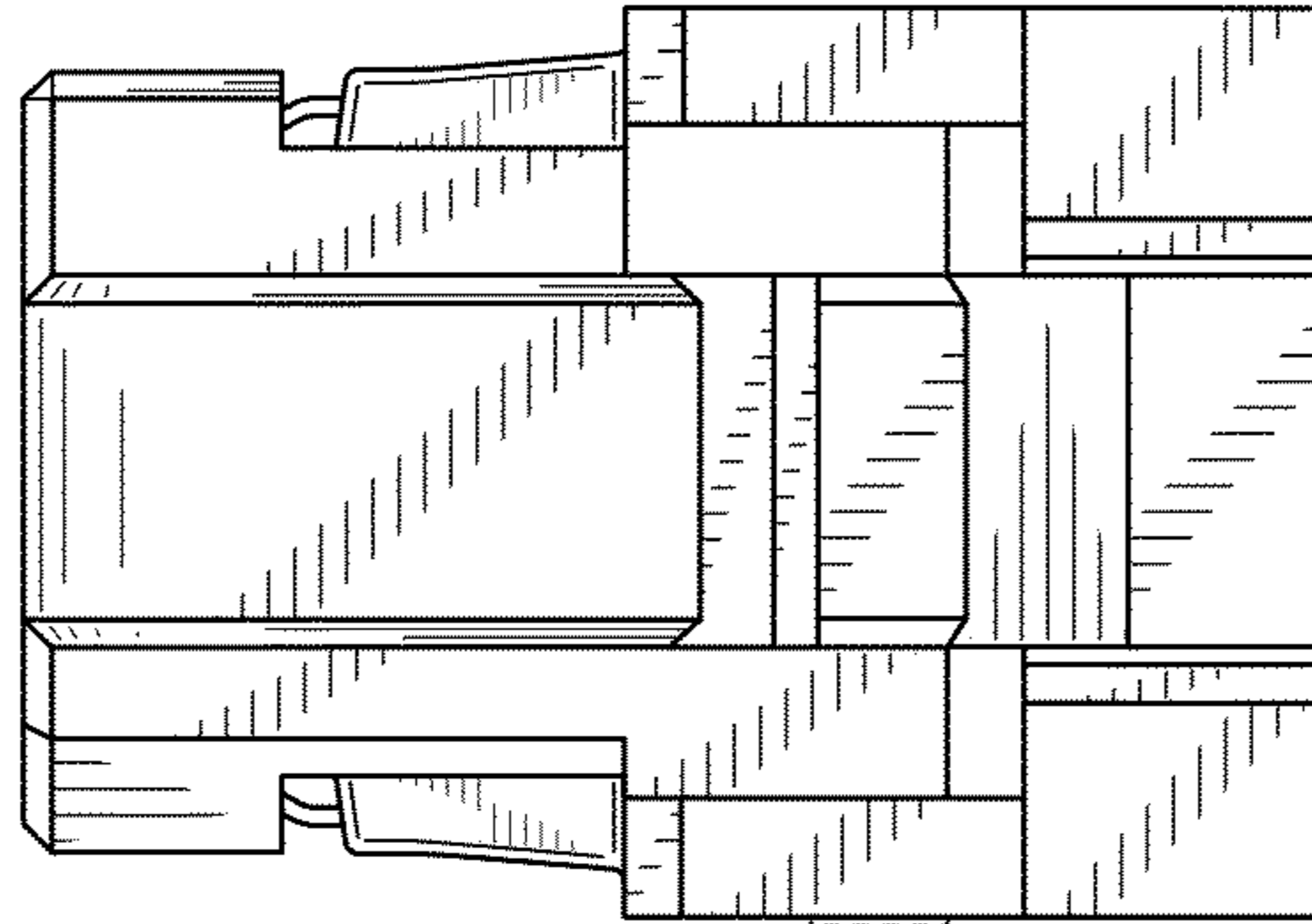

FIG. 7

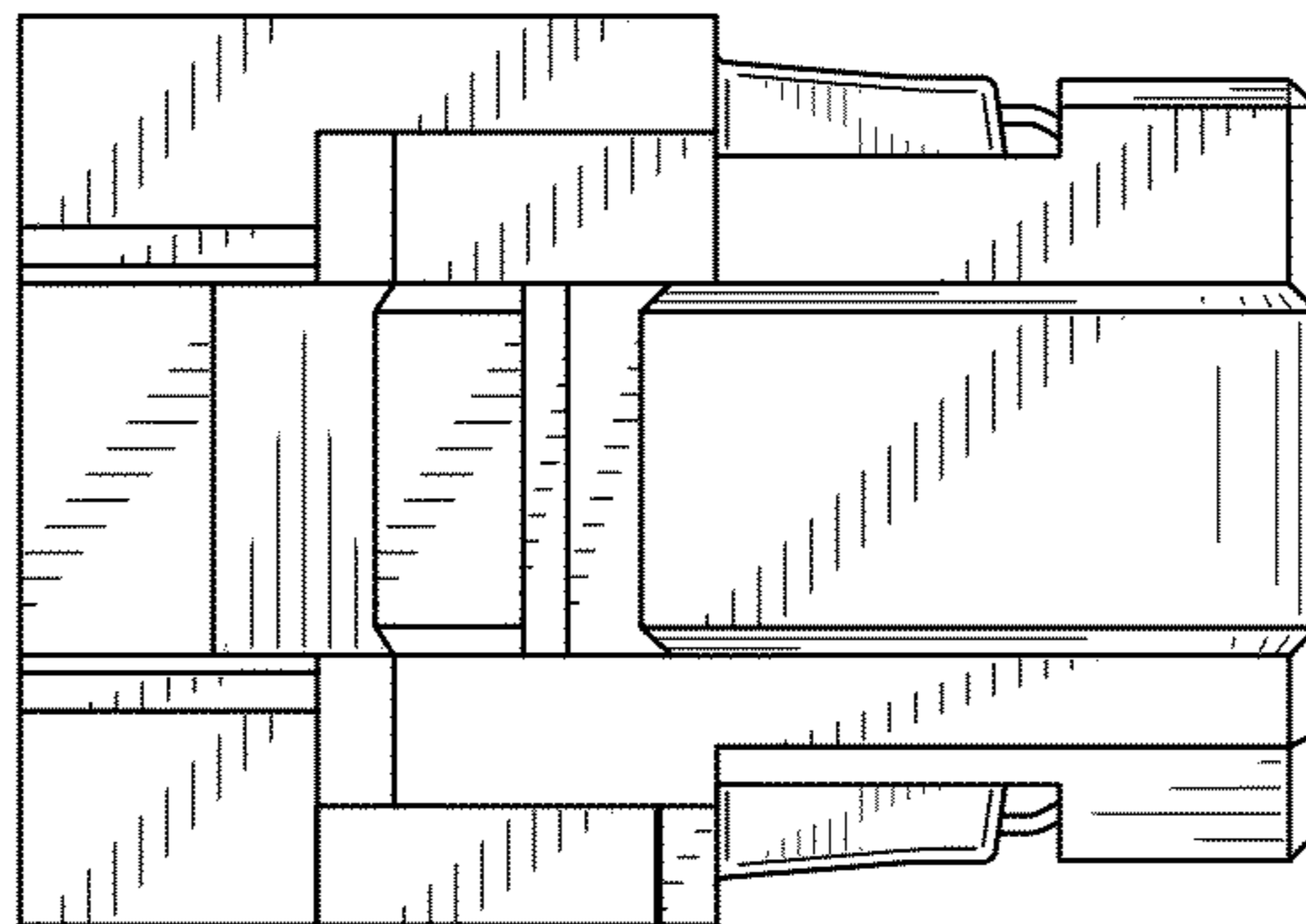

FIG. 8