



US00D708133S

(12) **United States Design Patent**
Hakala et al.

(10) **Patent No.:** **US D708,133 S**

(45) **Date of Patent:** **** Jul. 1, 2014**

(54) **FREQUENCY CONVERTER**

(75) Inventors: **Jani Hakala**, Espoo (FI); **Mika Silvennoinen**, Espoo (FI)

(73) Assignee: **ABB Oy**, Helsinki (FI)

(**) Term: **14 Years**

(21) Appl. No.: **29/371,781**

(22) Filed: **Sep. 22, 2011**

(30) **Foreign Application Priority Data**

Apr. 8, 2011	(EM)	001271134-0001
Apr. 8, 2011	(EM)	001271134-0002
Apr. 8, 2011	(EM)	001271134-0003
Apr. 8, 2011	(EM)	001271134-0004

(51) **LOC (10) Cl.** **13-02**

(52) **U.S. Cl.**
USPC **D13/110**

(58) **Field of Classification Search**
USPC D13/101, 110, 123, 184, 199;
307/150-152; 261/600, 601, 622, 702,
261/703, 730, 796, 809; 363/141, 142
See application file for complete search history.

(56) **References Cited**

U.S. PATENT DOCUMENTS

D365,086	S	*	12/1995	Spechts	D13/184
D428,393	S	*	7/2000	Nelson et al.	D13/184
D435,828	S	*	1/2001	Chou	D13/110
6,169,661	B1	*	1/2001	Lee	361/752
6,459,589	B2	*	10/2002	Manweiler et al.	361/752
D488,776	S	*	4/2004	Su et al.	D13/110
6,842,348	B2	*	1/2005	Lee	361/796
D562,234	S	*	2/2008	Morihara et al.	D13/110
D586,744	S	*	2/2009	Jaskari	D13/110
D598,847	S	*	8/2009	Ota	D13/110
2008/0174948	A1	*	7/2008	Davis	361/684

* cited by examiner

Primary Examiner — Derrick Holland

Assistant Examiner — Lauren Calve

(74) *Attorney, Agent, or Firm* — Dykema Gossett PLLC

(57) **CLAIM**

The ornamental design for a frequency converter, as shown and described.

DESCRIPTION

FIG. 1 is a perspective view of a frequency converter showing our new design;

FIG. 2 is a front view thereof;

FIG. 3 is a rear view thereof;

FIG. 4 is a right side view thereof;

FIG. 5 is a left side view thereof;

FIG. 6 is a top view thereof;

FIG. 7 is a bottom view thereof;

FIG. 8 is a second perspective view thereof; and

FIG. 9 is a third perspective view thereof;

FIG. 10 is a perspective view of a frequency converter of a second embodiment showing our new design;

FIG. 11 is a front view thereof;

FIG. 12 is a rear view thereof;

FIG. 13 is a right side view thereof;

FIG. 14 is a left side view thereof;

FIG. 15 is a top view thereof;

FIG. 16 is a bottom view thereof;

FIG. 17 is a second perspective view thereof;

FIG. 18 is a third perspective view thereof; and,

FIG. 19 is a fourth perspective view thereof.

The broken line showing of the frequency converter represents unclaimed subject matter and forms no part of the claimed design.

1 Claim, 19 Drawing Sheets

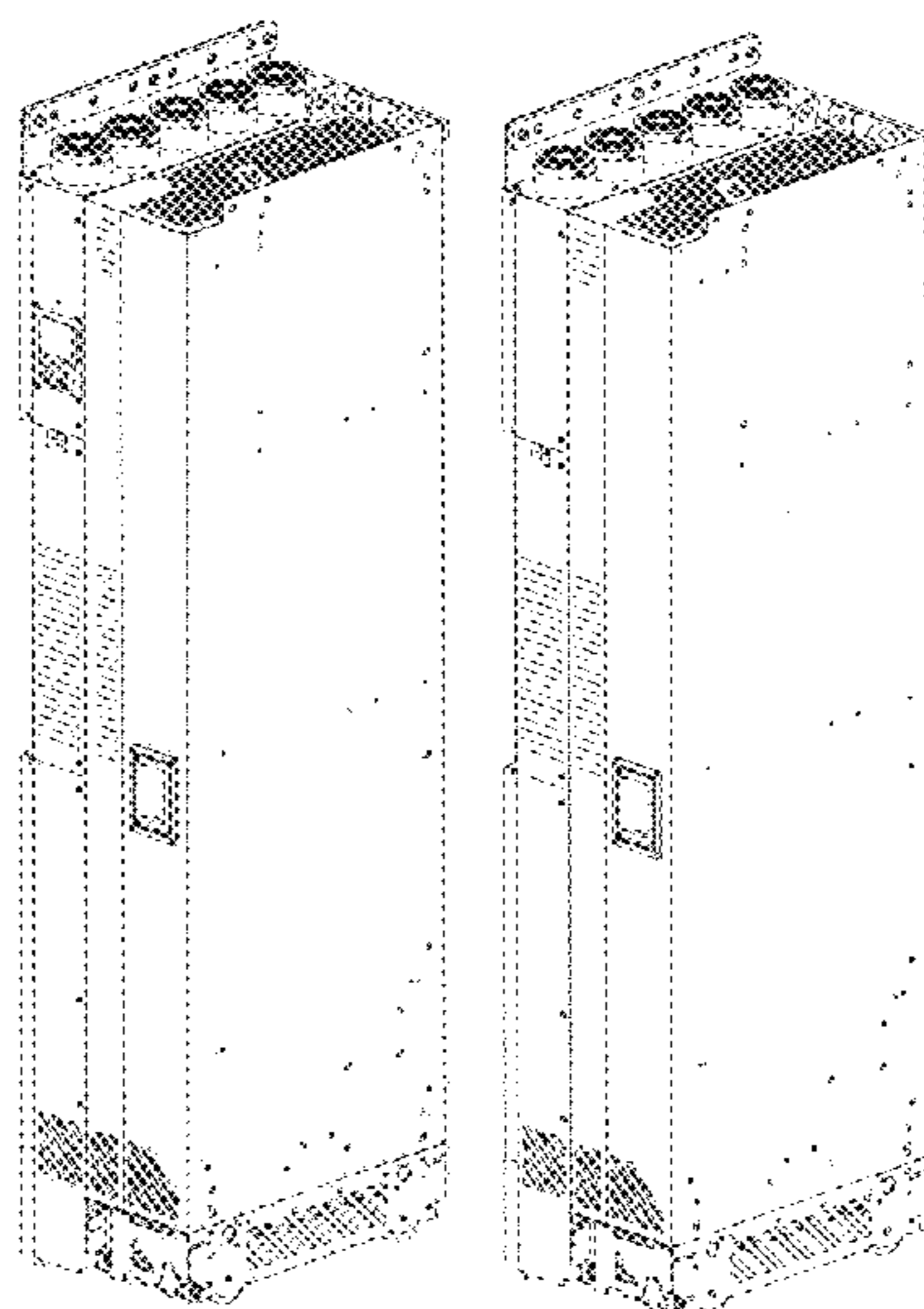

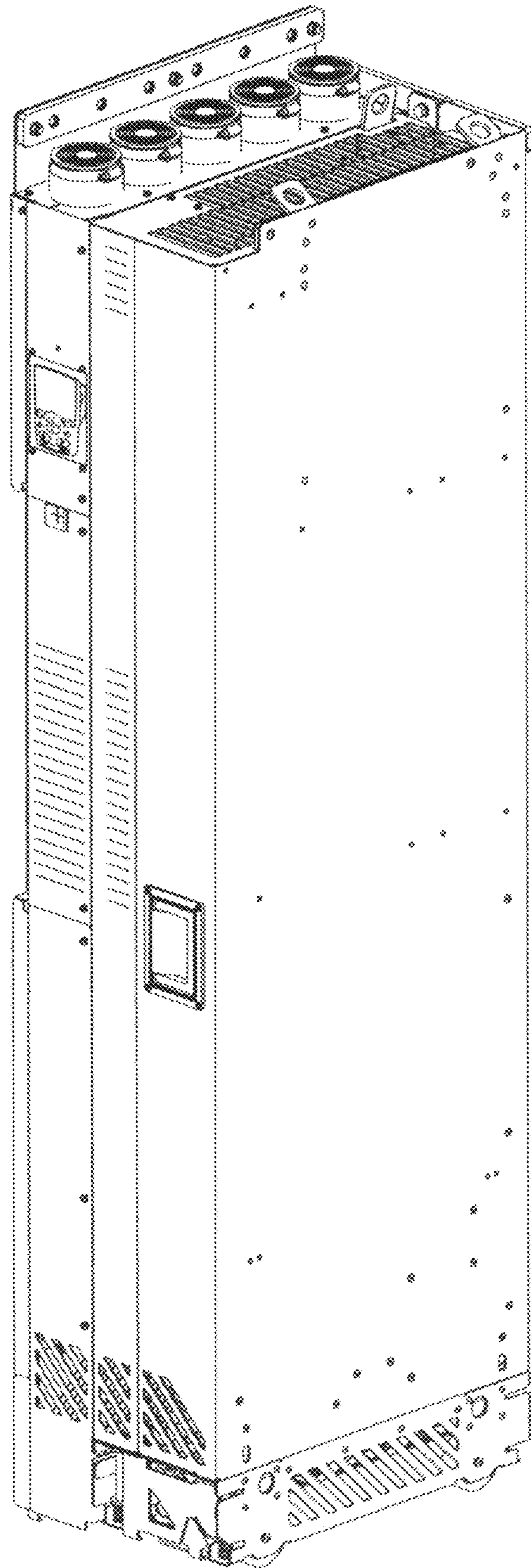

FIG. 1

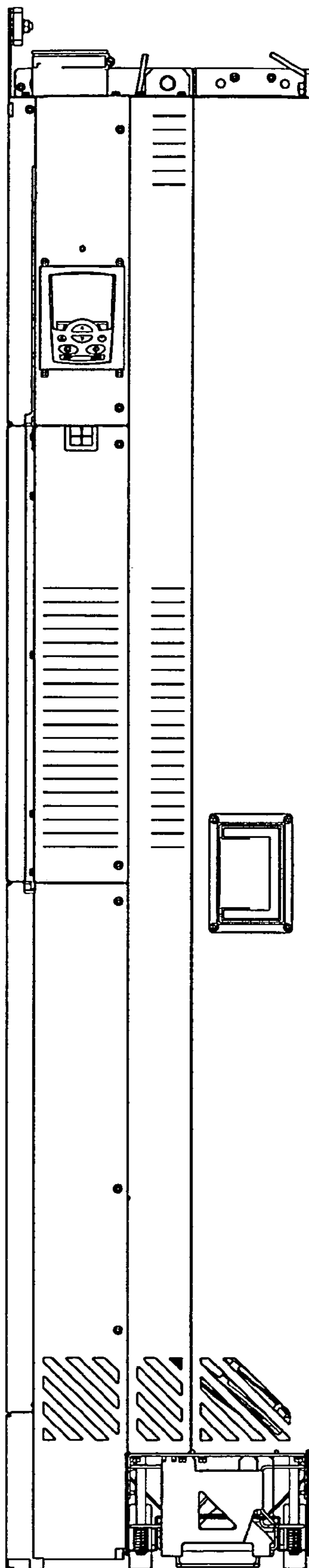

FIG. 2

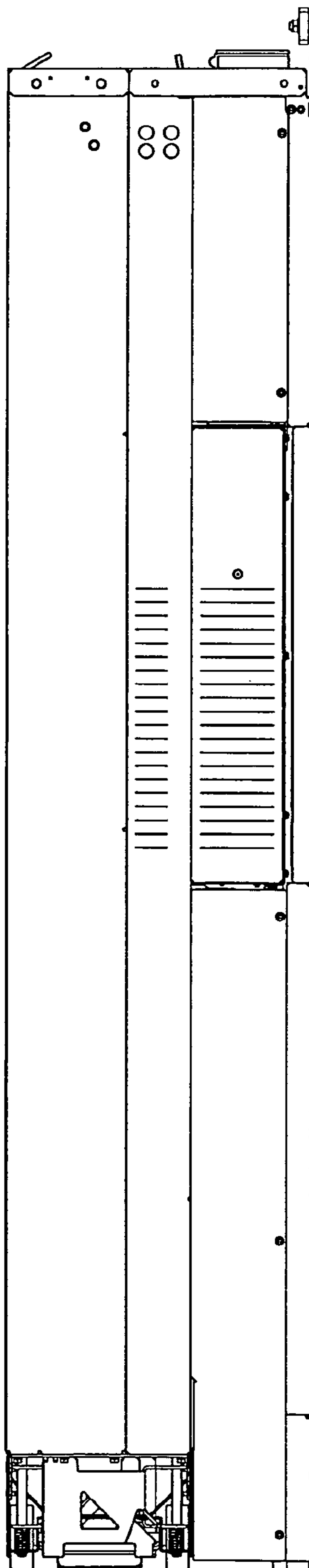

FIG. 3

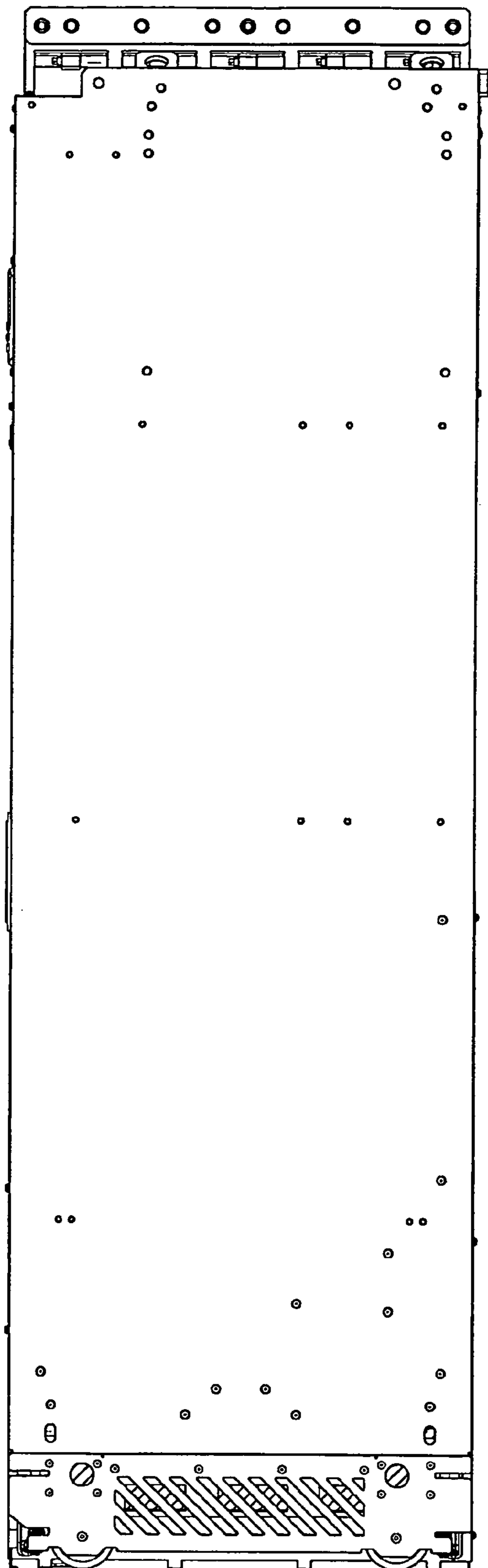

FIG. 4

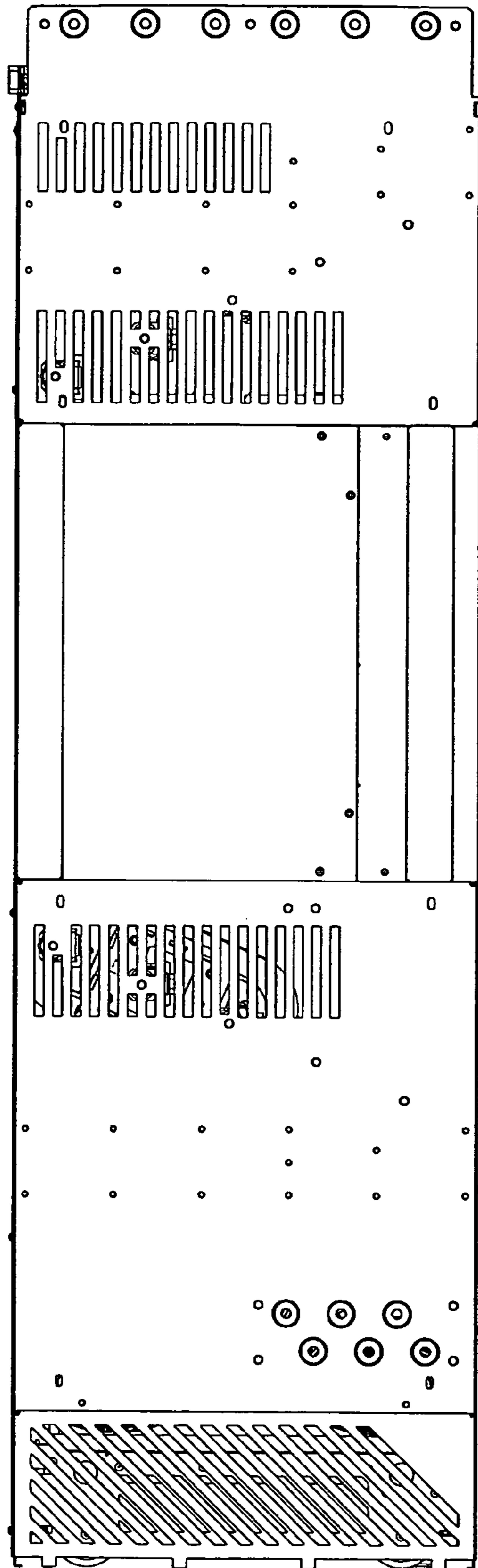

FIG. 5

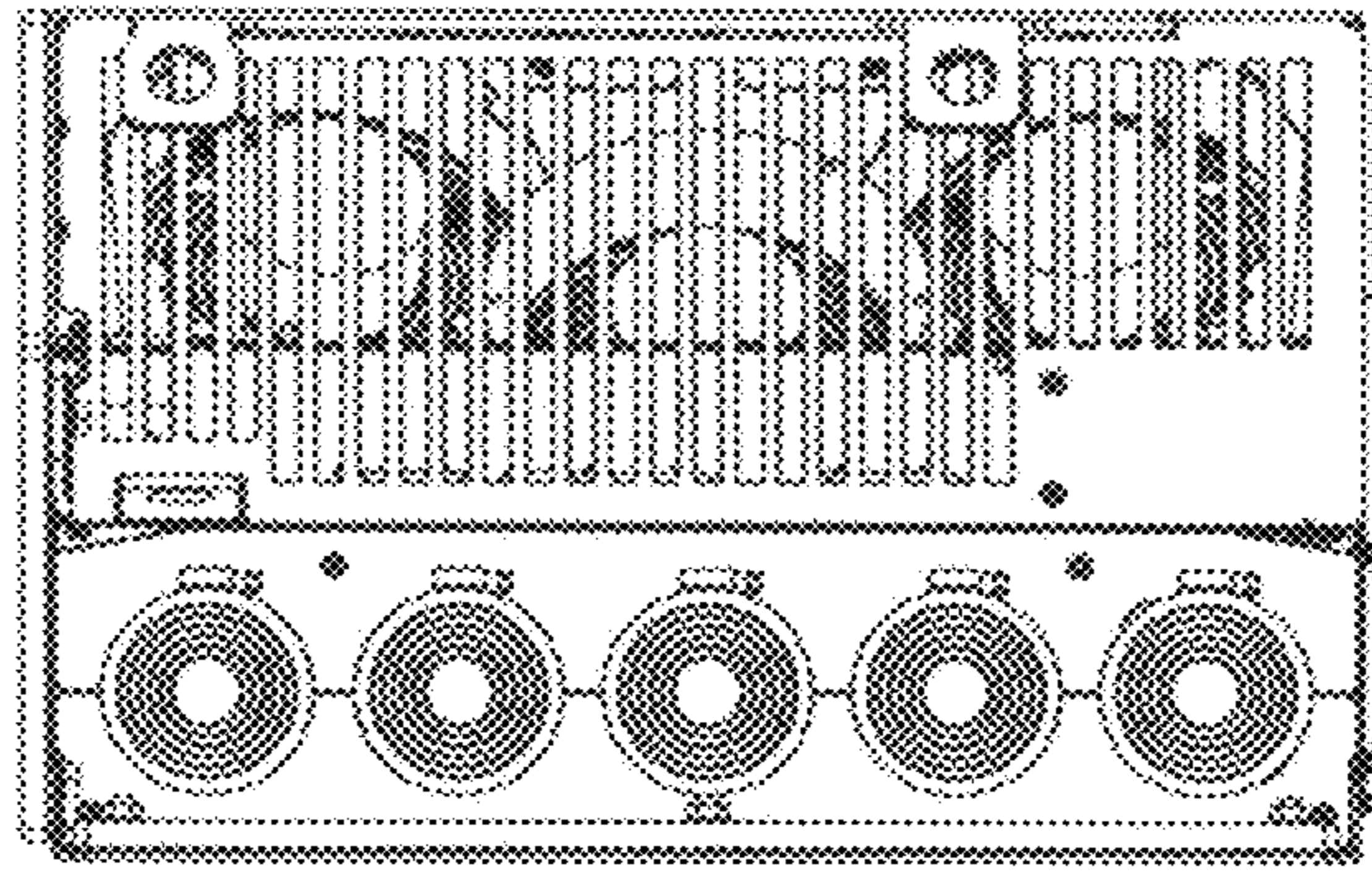

Fig. 6

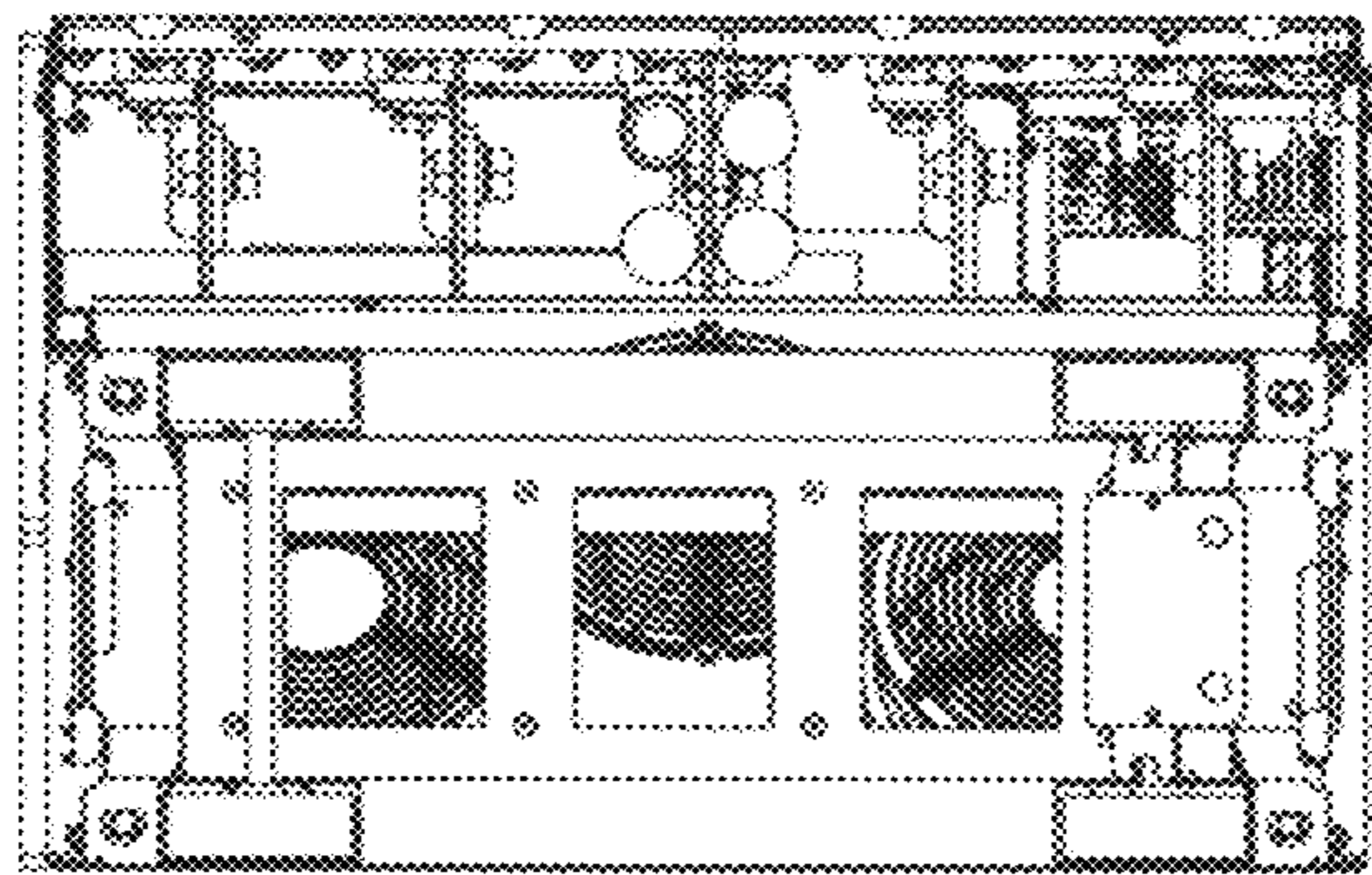

FIG. 7

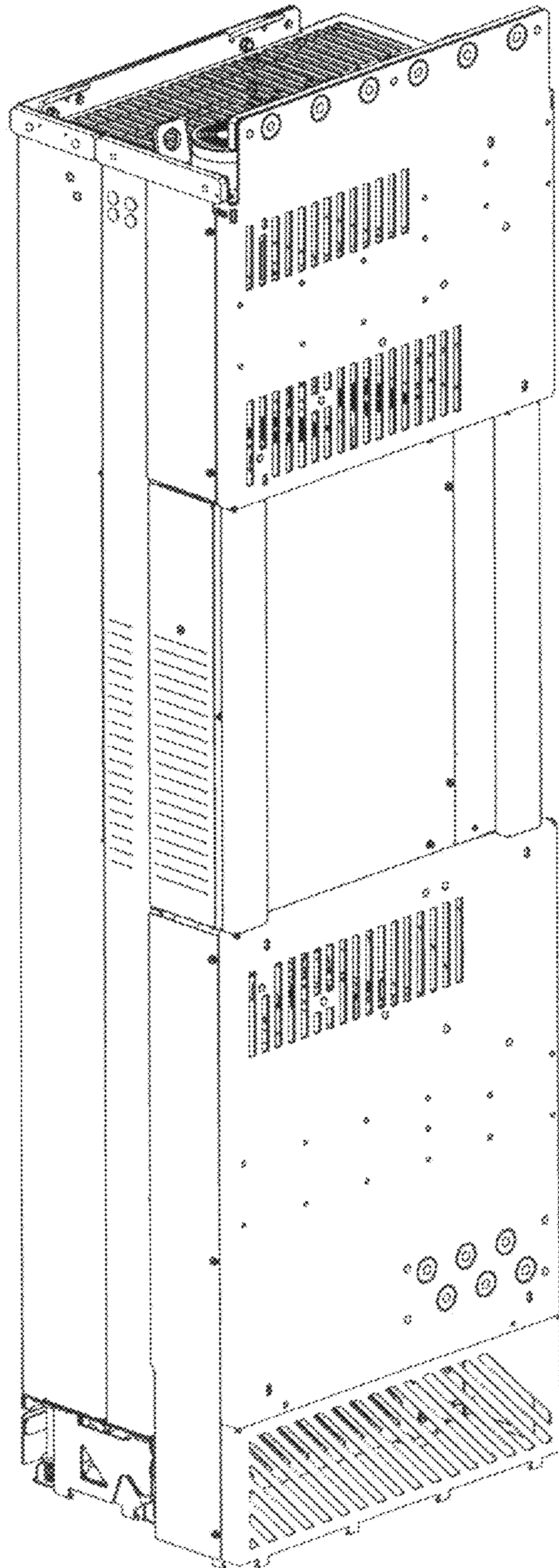

FIG. 8

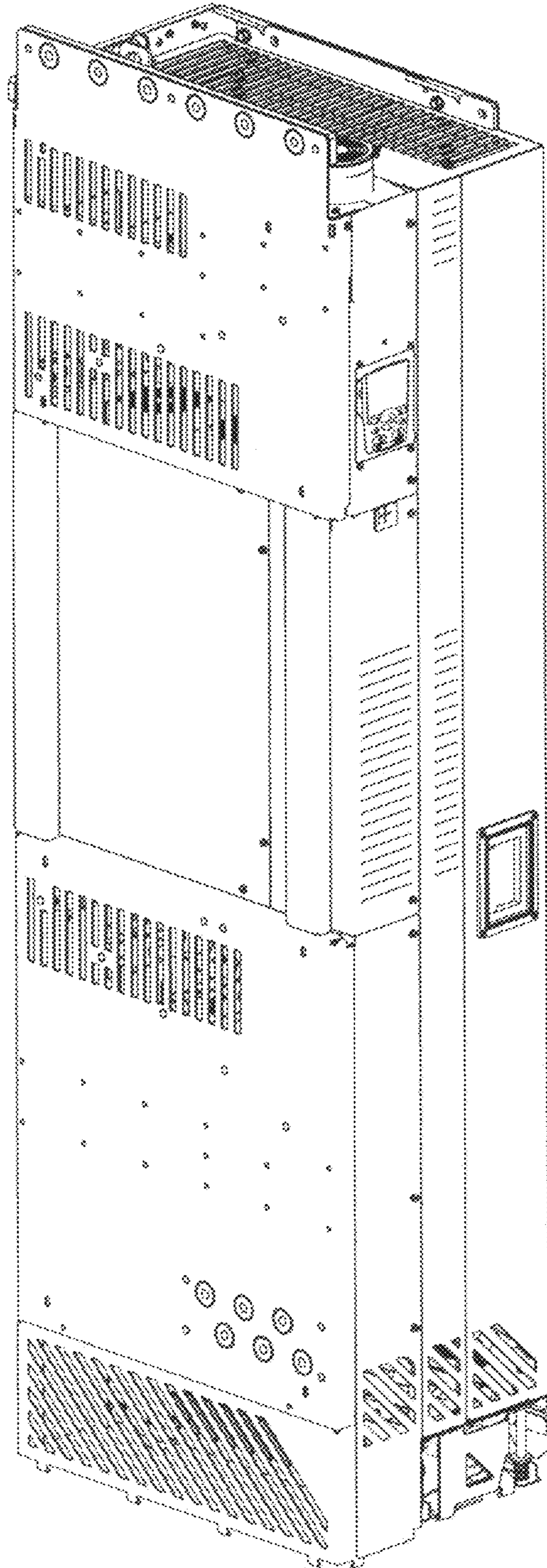

FIG. 9

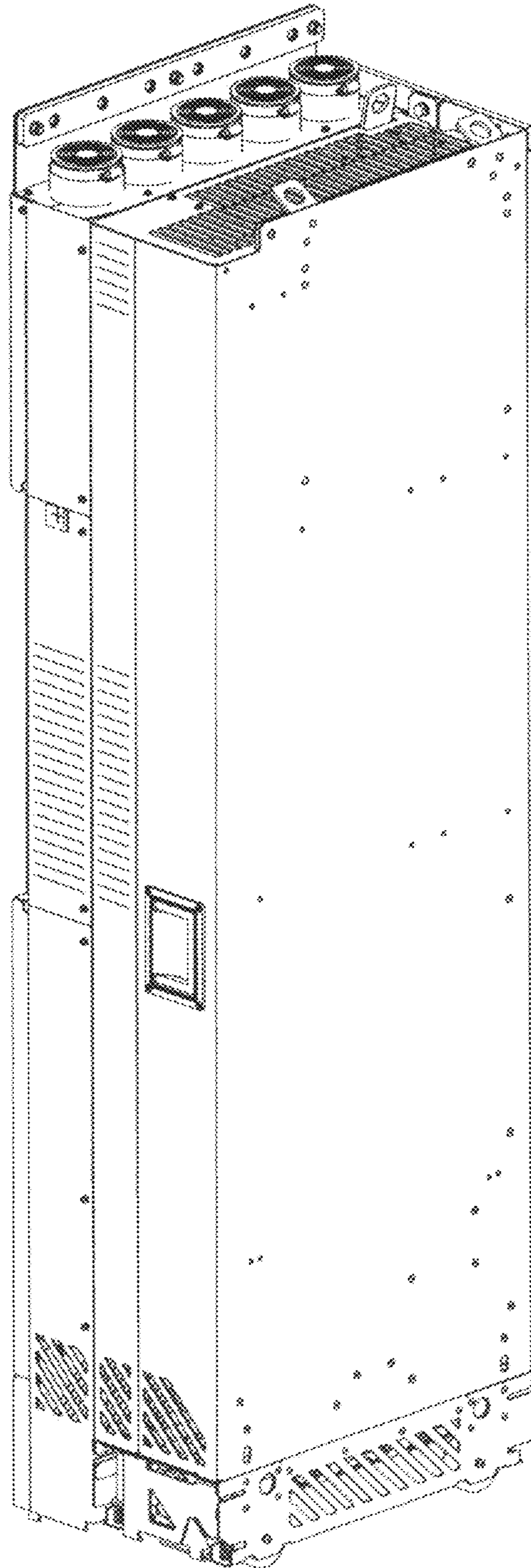

FIG. 10

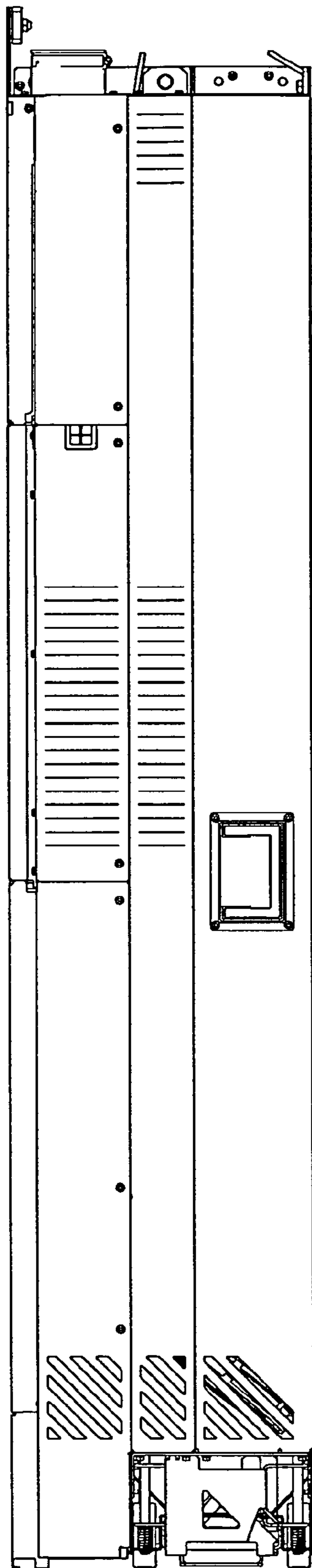

FIG. 11

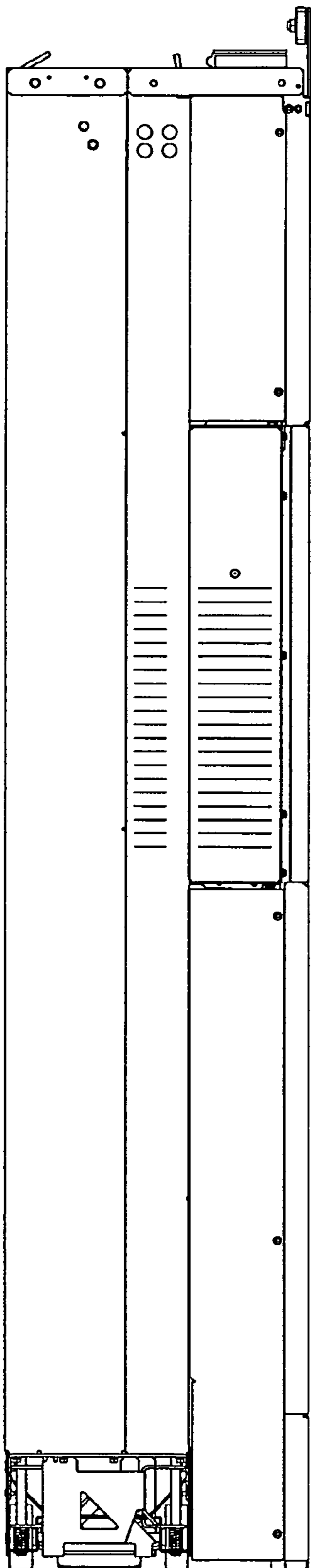

FIG. 12

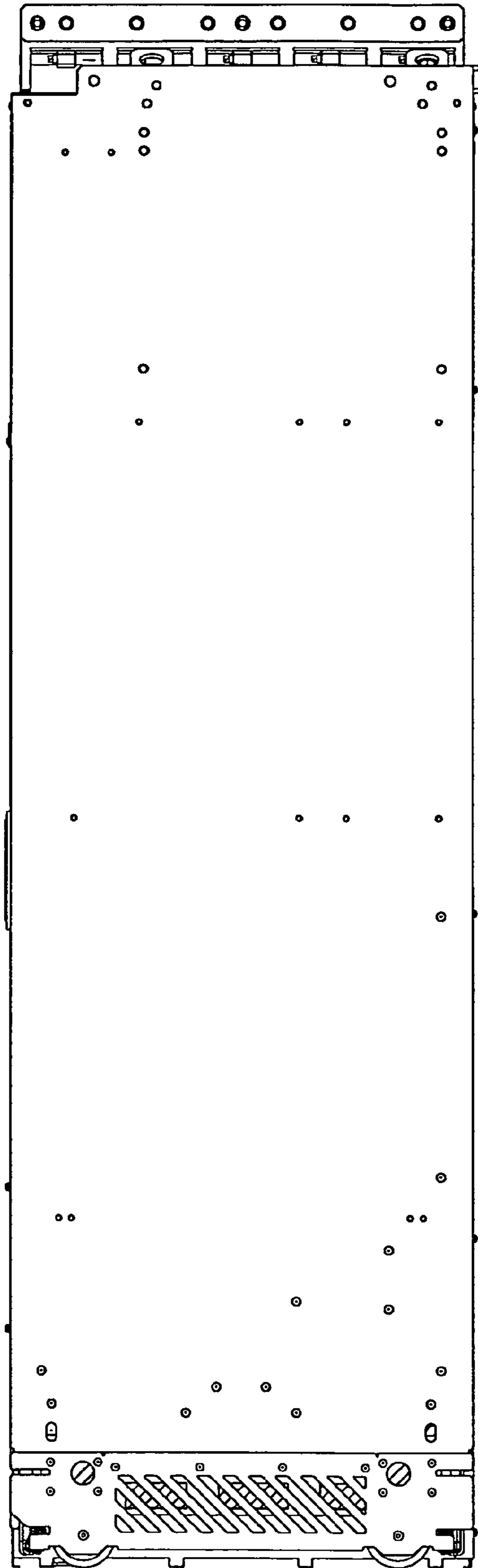

FIG. 13

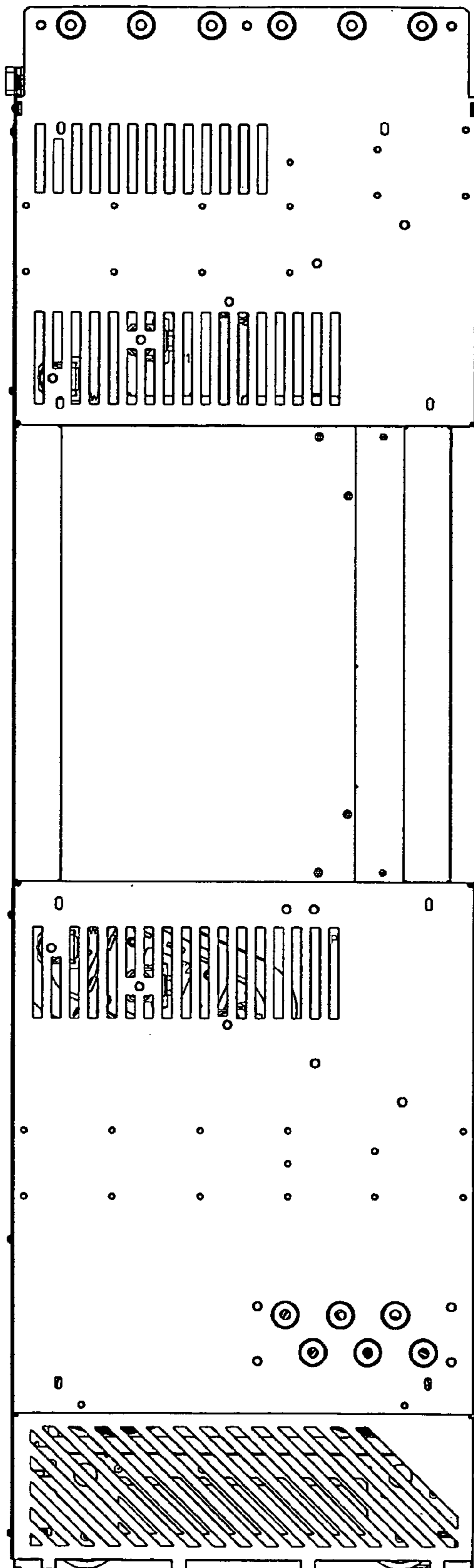

FIG. 14

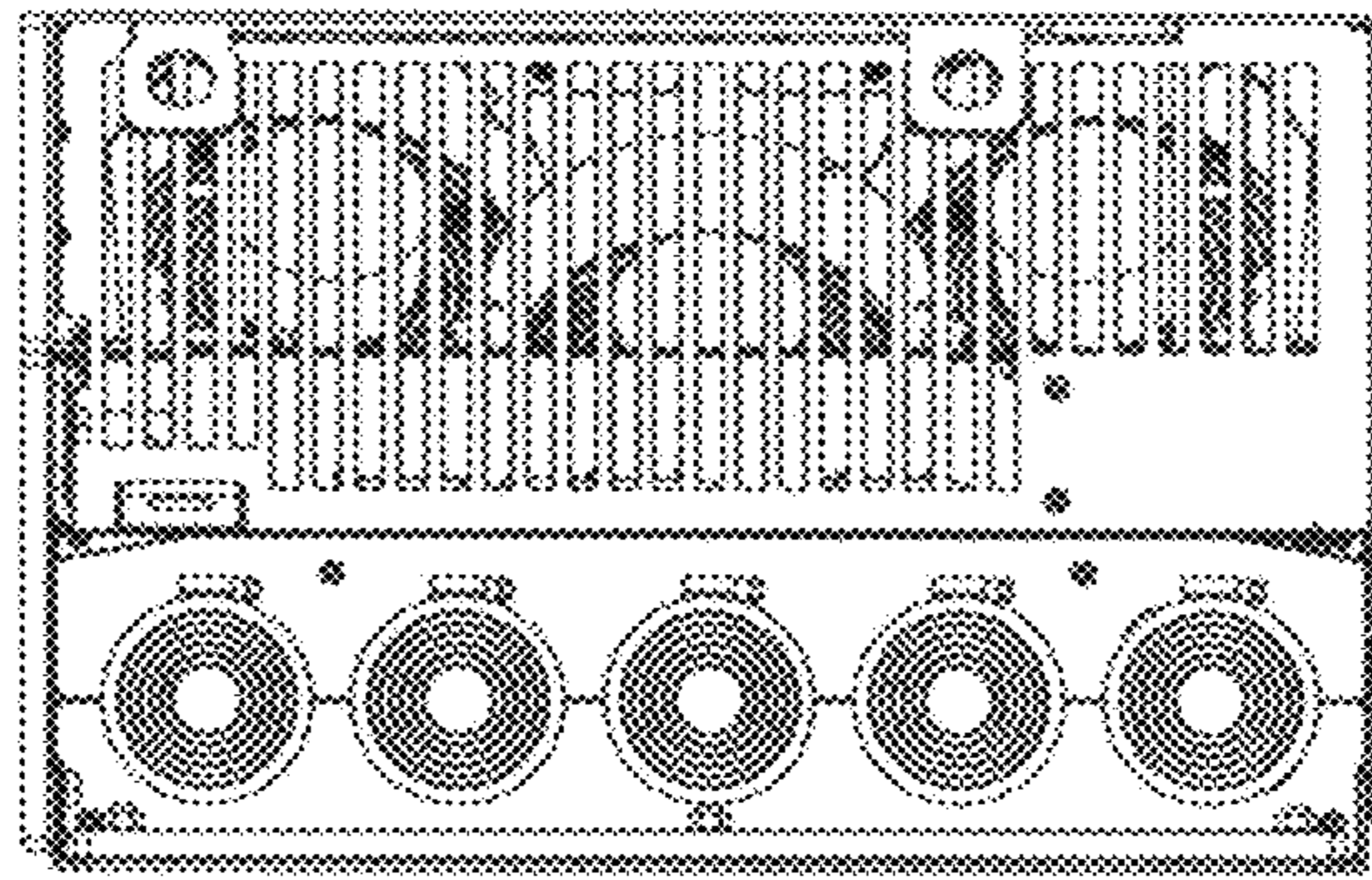

FIG. 15

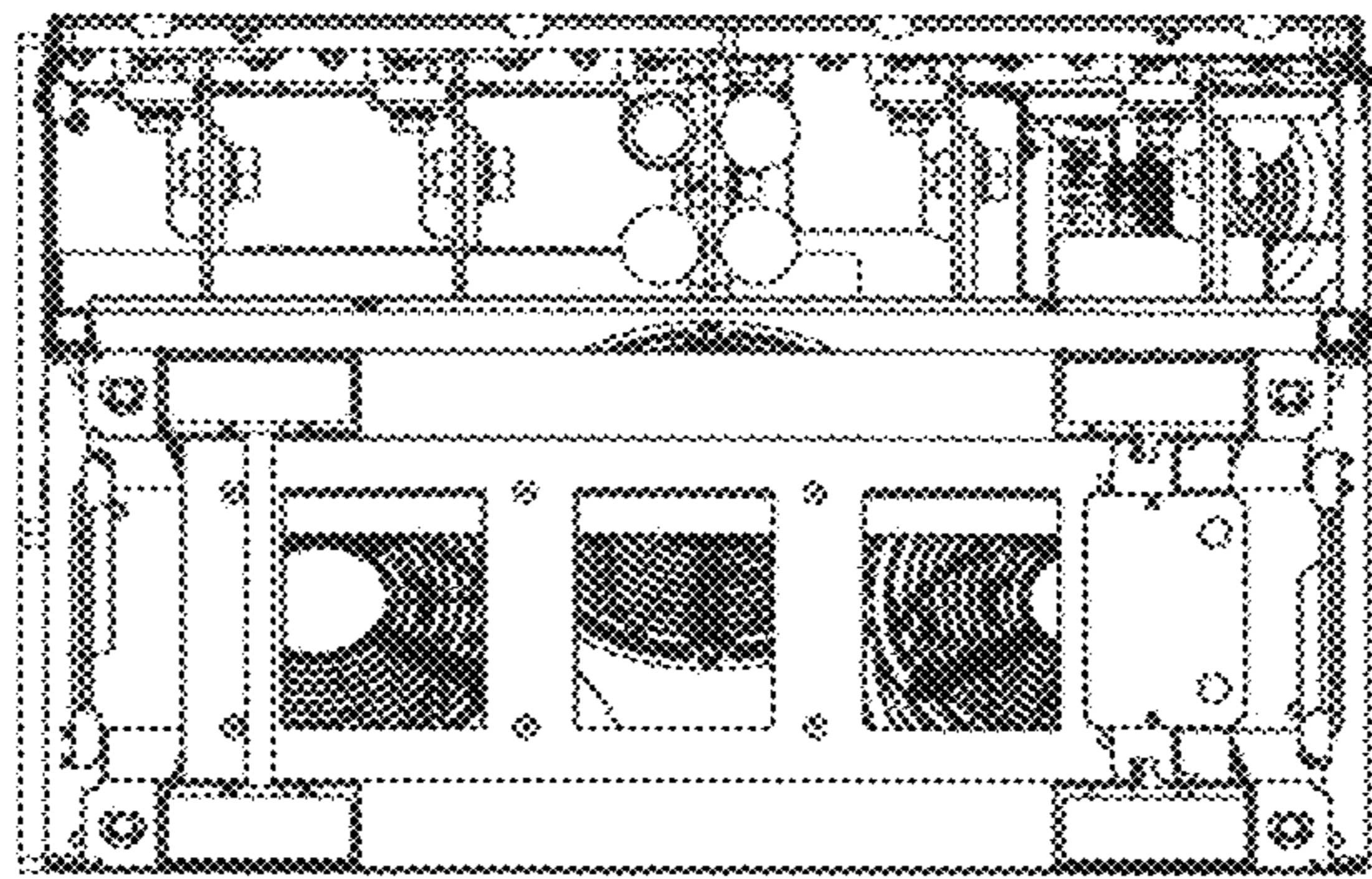

FIG. 16

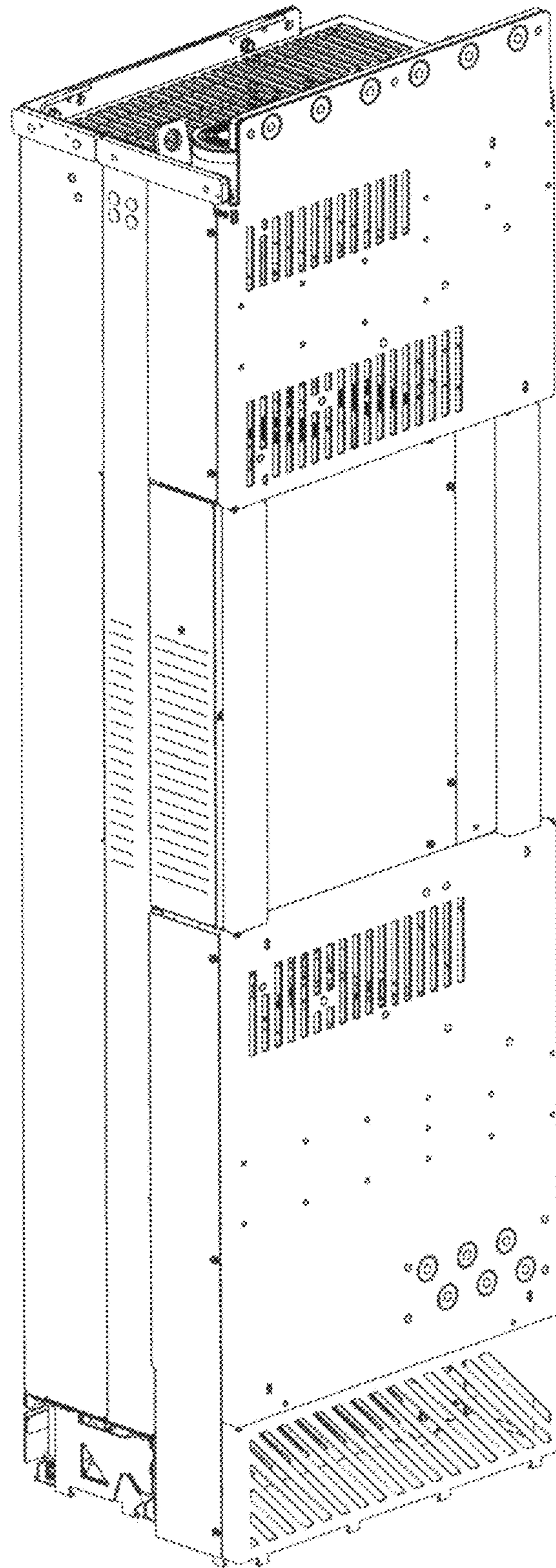

FIG. 17

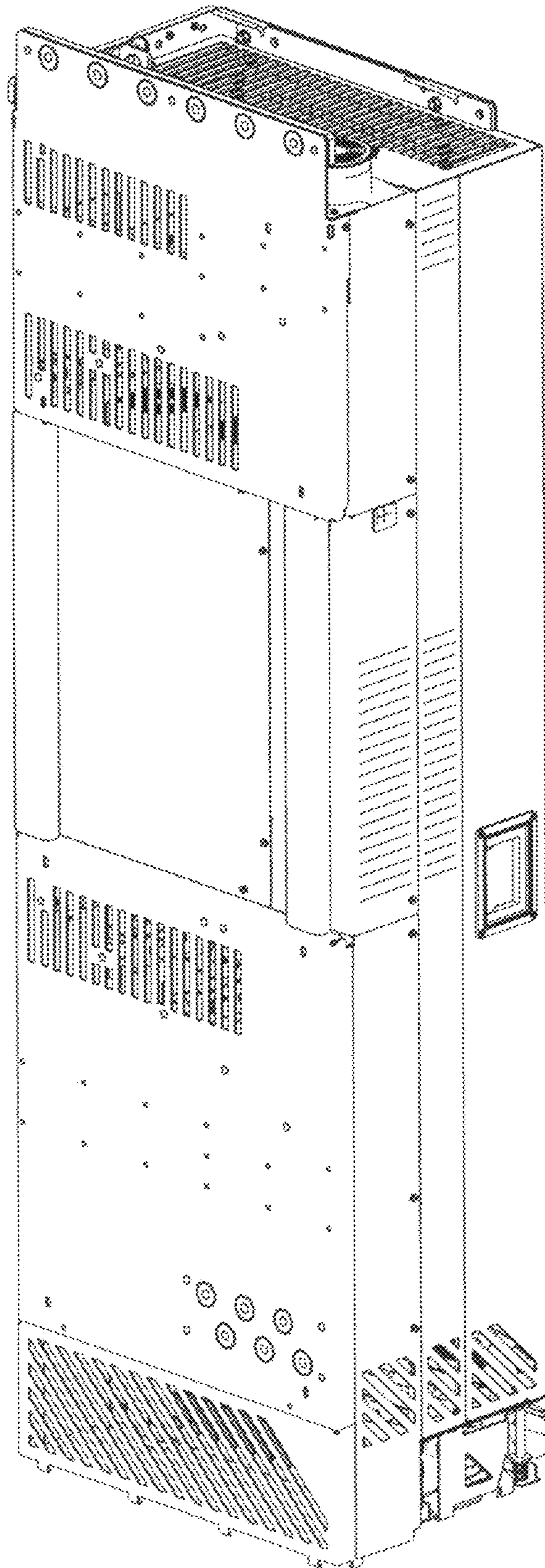

FIG. 18

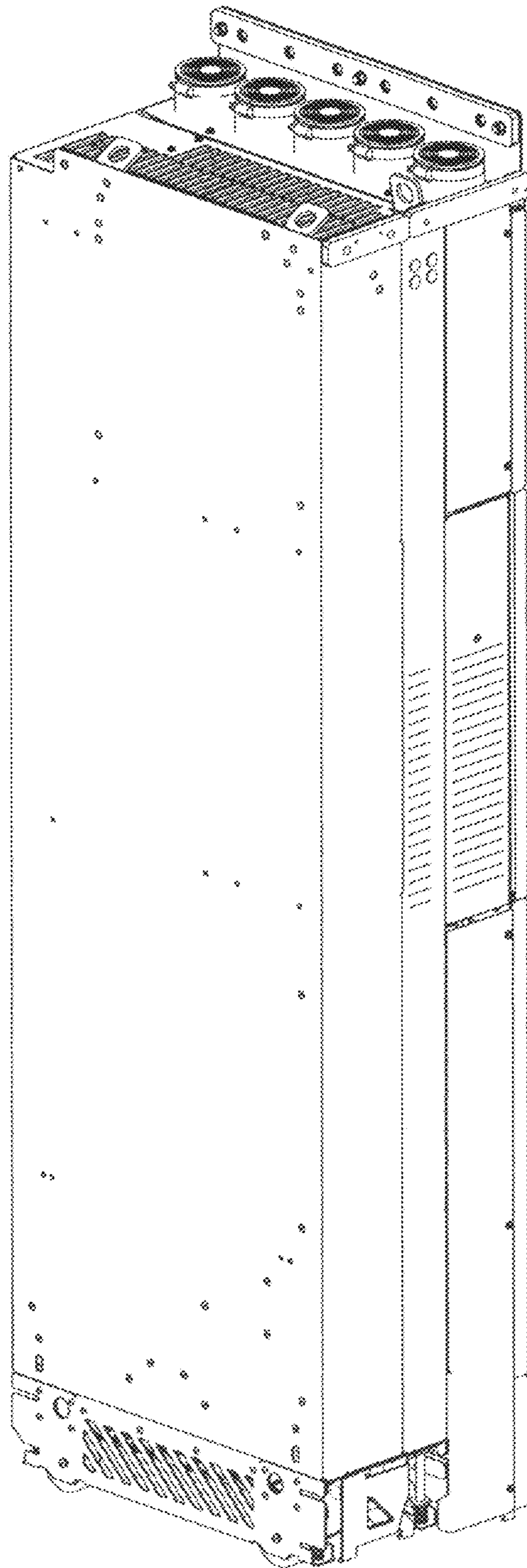

FIG. 19