

US00D708087S

(12) **United States Design Patent**  
**Yu**

(10) **Patent No.:** **US D708,087 S**  
(45) **Date of Patent:** **\*\* Jul. 1, 2014**

(54) **SIREN BOX**

(71) Applicant: **Ningbo Yinzhou Self Photoelectron Technology Co., Ltd., Zhejiang (CN)**

(72) Inventor: **Feng Yu, Zhejiang (CN)**

(73) Assignee: **Ningbo Yinzhou Self Photoelectron Technology Co., Ltd., Ningbo (CN)**

(\*\*) Term: **14 Years**

(21) Appl. No.: **29/458,933**

(22) Filed: **Jun. 24, 2013**

(30) **Foreign Application Priority Data**

Feb. 1, 2013 (CN) ..... 2013 3 0032684

(51) **LOC (10) Cl.** ..... **10-05**

(52) **U.S. Cl.**  
USPC ..... **D10/120**

(58) **Field of Classification Search**  
USPC ..... D10/116.1-120, 104.1, 106.1;  
340/388.1; 116/142 FP, 142 R;  
D14/160, 385; 70/15

See application file for complete search history.

(56) **References Cited**

U.S. PATENT DOCUMENTS

D260,741	S	*	9/1981	Lam	.....	D10/106.1
D376,148	S	*	12/1996	Moallemi et al.	.....	D14/160
D390,837	S	*	2/1998	Hower et al.	.....	D14/385
D519,394	S	*	4/2006	DiPasquale	.....	D10/106.1
D527,296	S	*	8/2006	Concari et al.	.....	D10/106.1
D581,303	S	*	11/2008	Concari	.....	D10/104.1
2012/0318027	A1	*	12/2012	Shute et al.	.....	70/15

\* cited by examiner

*Primary Examiner* — George D Kirschbaum

(57) **CLAIM**

The ornamental design for a siren box, as shown and described.

**DESCRIPTION**

FIG. 1 is a front view of a siren box of my new design; FIG. 2 is a rear view of the siren box thereof; FIG. 3 is a left side view of the siren box thereof; FIG. 4 is a right side view of the siren box thereof; FIG. 5 is a top view of the siren box thereof; FIG. 6 is a bottom view of the siren box thereof; and, FIG. 7 is a perspective view of the siren box thereof.

**1 Claim, 7 Drawing Sheets**

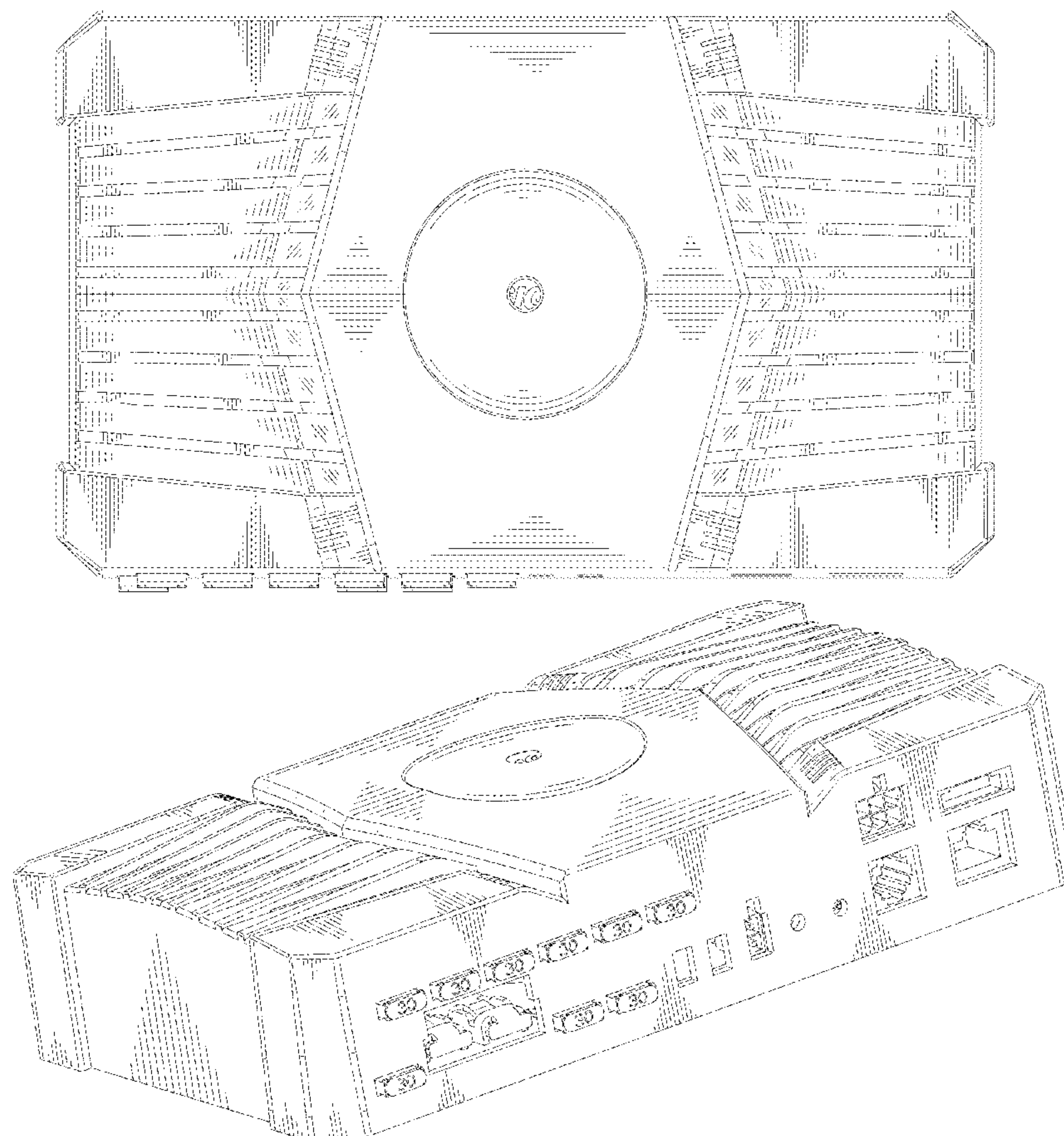

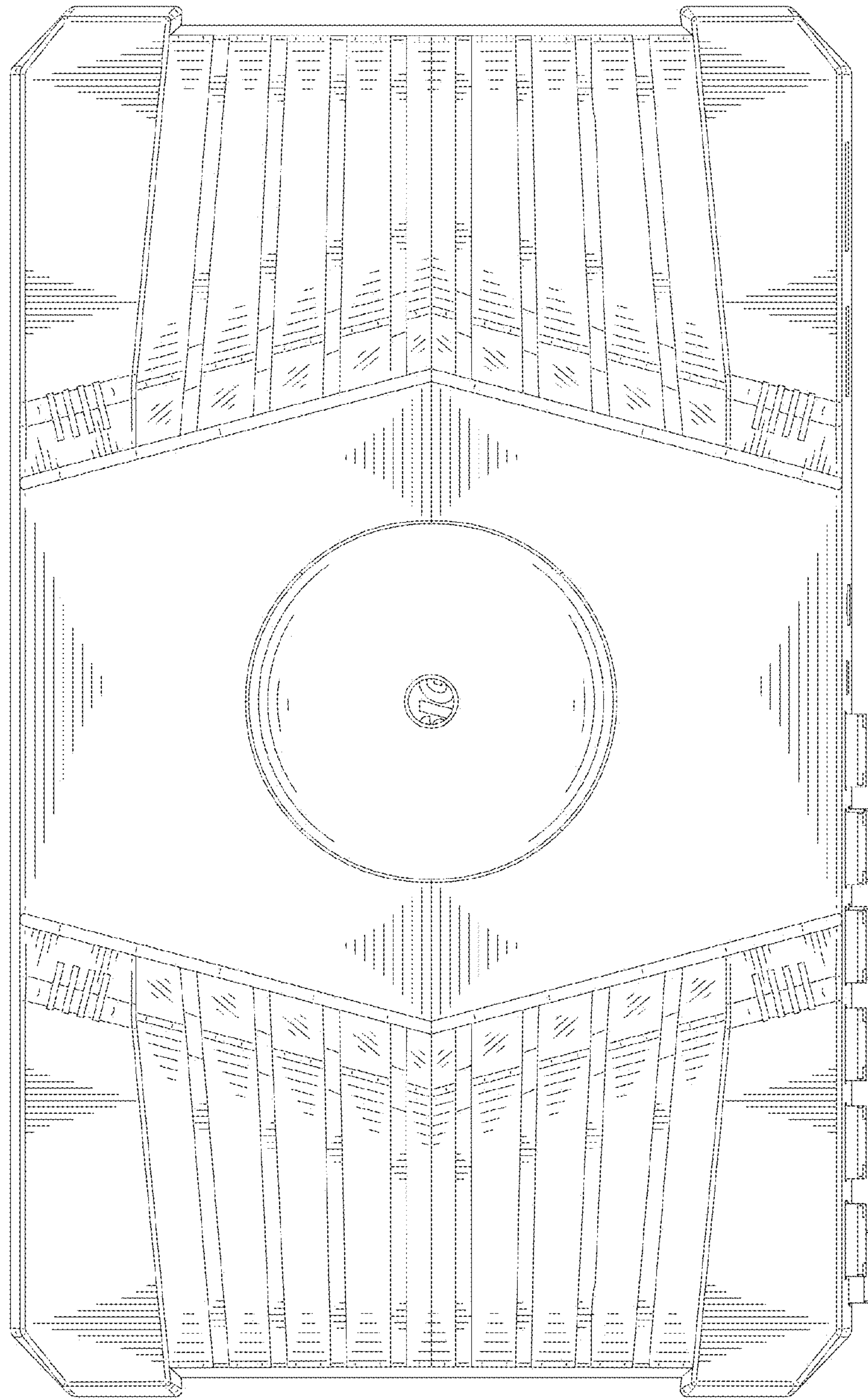

FIG.1

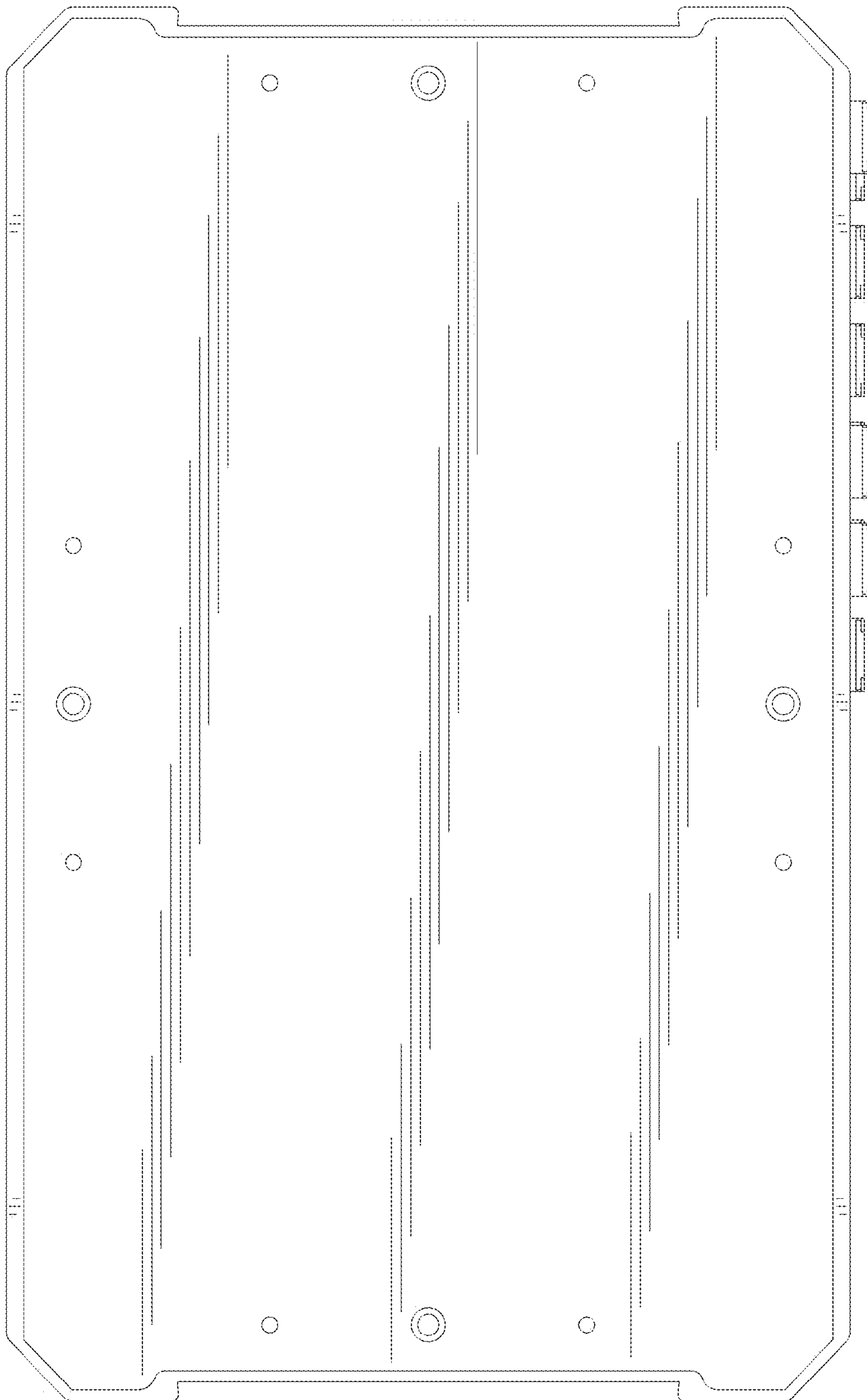

FIG.2



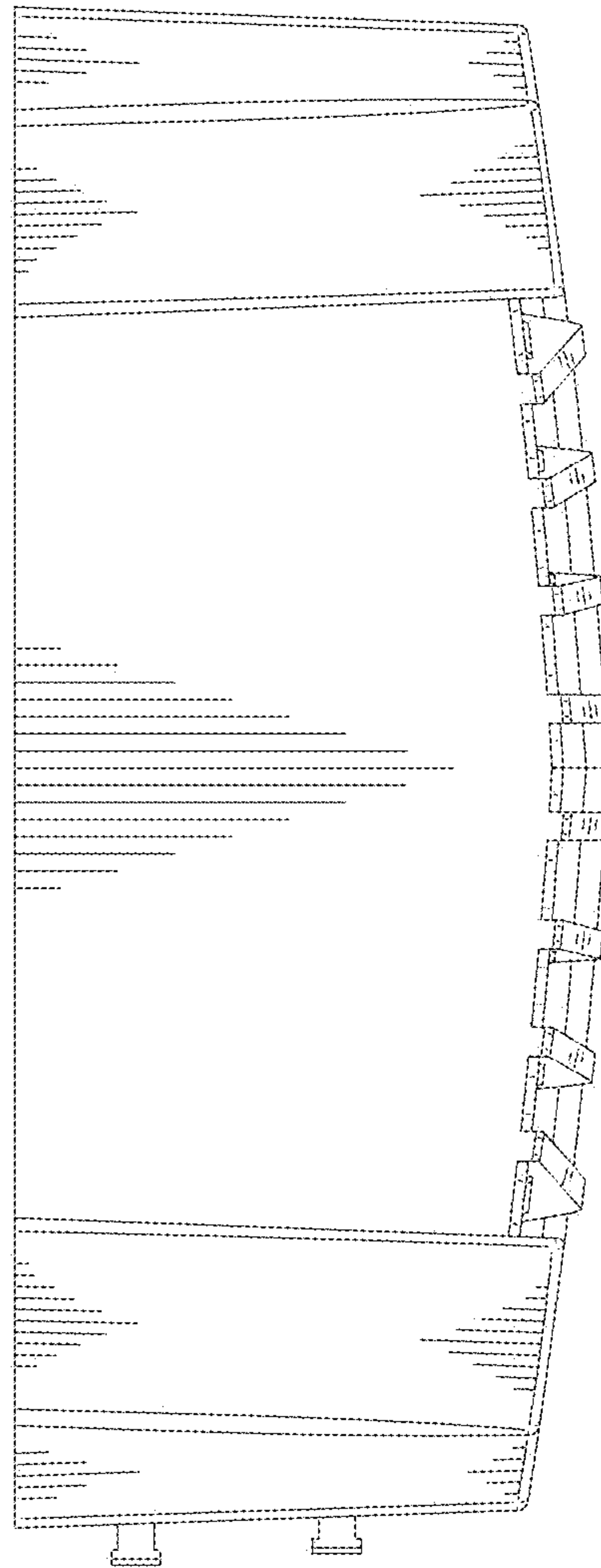

FIG.3

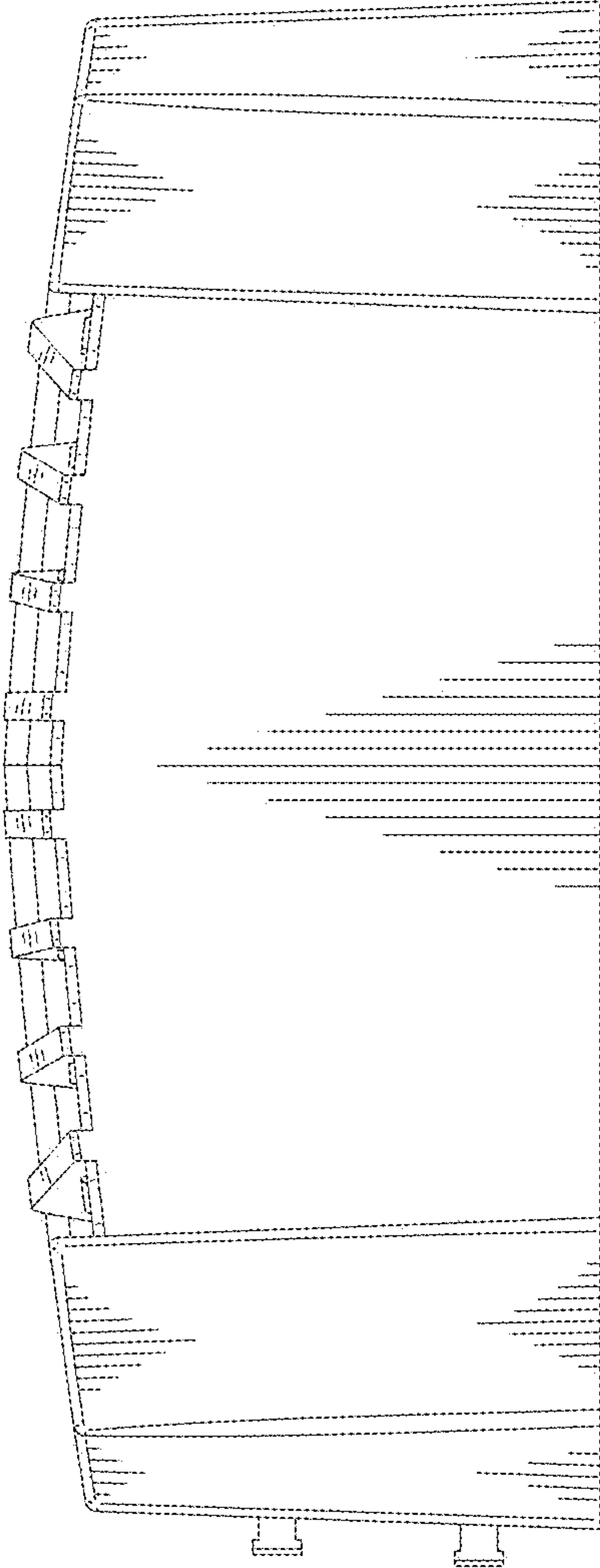

FIG.4

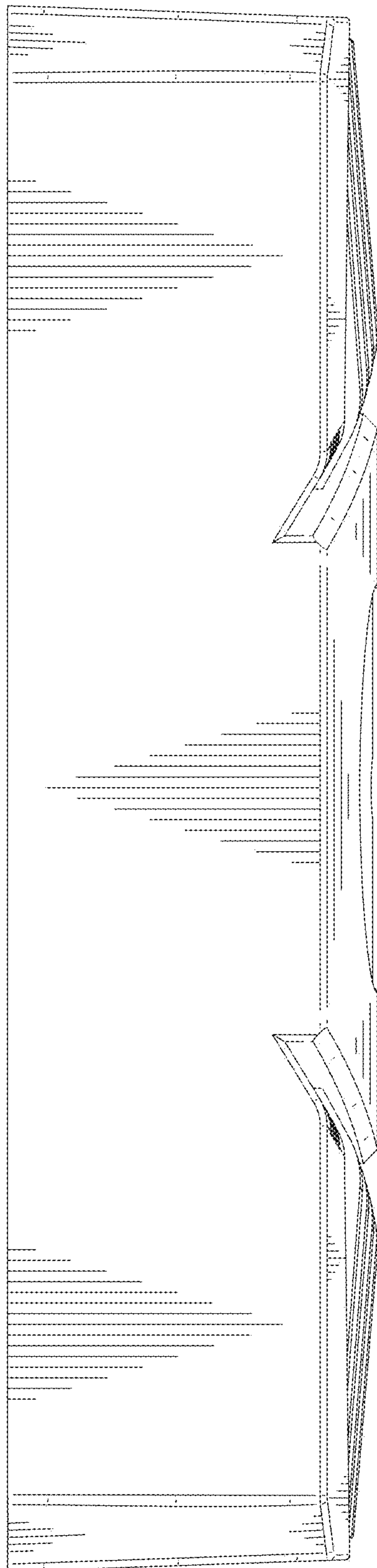

FIG.5



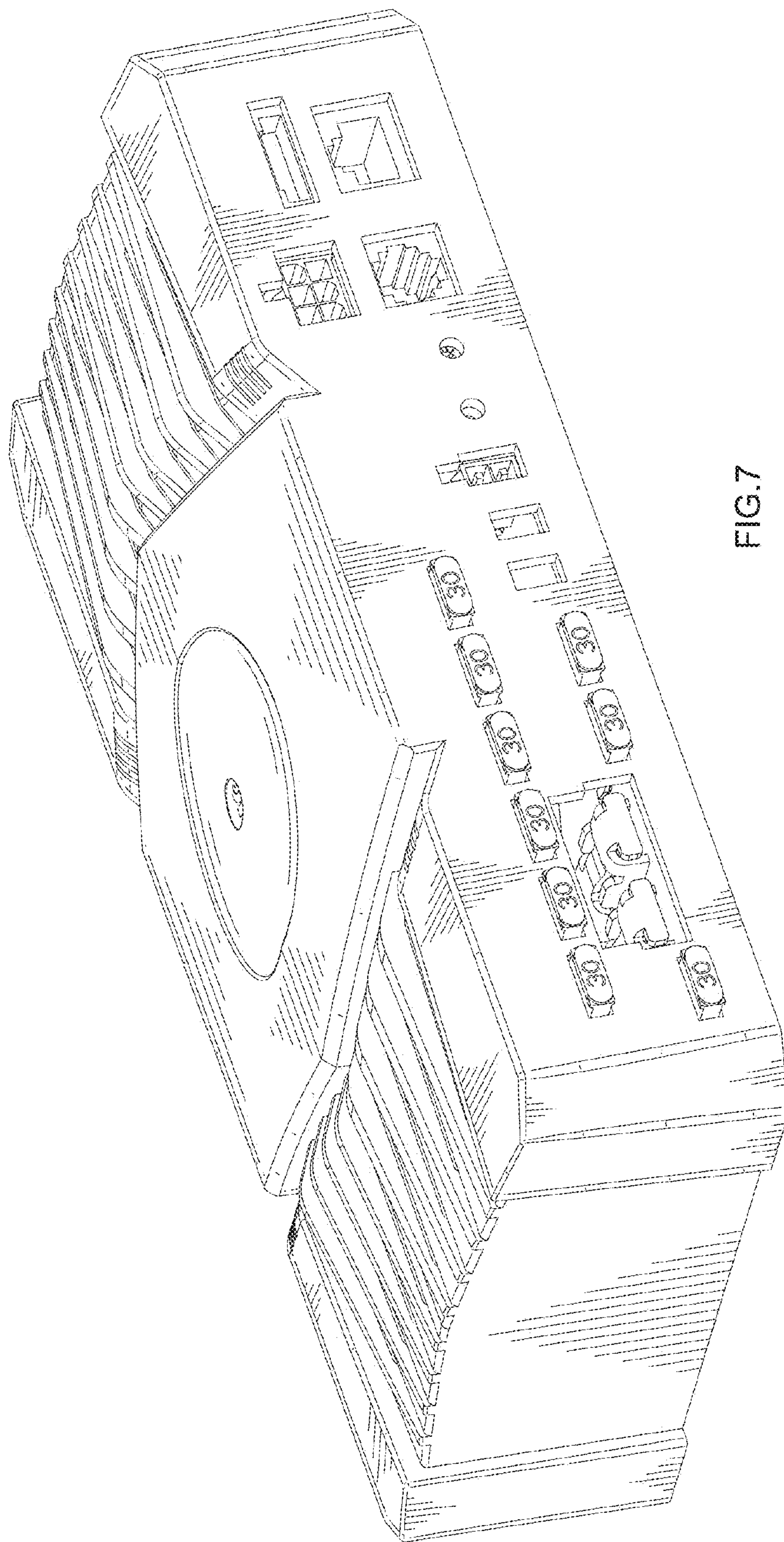

FIG.7



UNITED STATES PATENT AND TRADEMARK OFFICE  
**CERTIFICATE OF CORRECTION**

PATENT NO. : D708,087 S  
APPLICATION NO. : 29/458933  
DATED : July 1, 2014  
INVENTOR(S) : Feng Yu

Page 1 of 1

It is certified that error appears in the above-identified patent and that said Letters Patent is hereby corrected as shown below:

TITLE PAGE: ITEM (73)

The correct name of Assignee should be “Ningbo Yinzhou Self Photoelectron Technology Co., Ltd.”  
instead of “Ningbo Yinzhou Self Photoelectron Technology Co.,. Ltd.”

Signed and Sealed this  
Second Day of December, 2014



Michelle K. Lee  
*Deputy Director of the United States Patent and Trademark Office*