



US00D708065S

(12) **United States Design Patent**  
**Pourian**

(10) **Patent No.:** **US D708,065 S**  
(45) **Date of Patent:** **\*\* Jul. 1, 2014**

- (54) **COMESTIBLE DISPENSER**
- (71) Applicant: **Wm. Wrigley Jr. Company**, Chicago, IL (US)
- (72) Inventor: **Neema Pourian**, Chicago, IL (US)
- (73) Assignee: **Wm. Wrigley Jr. Company**, Chicago, IL (US)
- (\*\*) Term: **14 Years**
- (21) Appl. No.: **29/456,058**
- (22) Filed: **May 28, 2013**

- D217,058 S \* 3/1970 Marsh ..... D9/529 X
- D260,485 S \* 9/1981 Ortal ..... D9/542
- D279,077 S \* 6/1985 Drummond et al. .... D9/529 X
- D280,667 S \* 9/1985 Bennett ..... D9/529 X
- D308,128 S \* 5/1990 Paquette ..... D3/202
- D322,031 S \* 12/1991 Fleming ..... D9/424
- D433,634 S \* 11/2000 Nicolas ..... D9/520
- D443,505 S \* 6/2001 Finocchiaro et al. .... D9/544 X
- D479,689 S \* 9/2003 Altonen et al. .... D9/564 X
- D488,069 S \* 4/2004 Badya ..... D9/529
- D547,189 S \* 7/2007 Legros ..... D9/521
- D576,883 S \* 9/2008 Carapelli ..... D9/575 X
- D600,124 S \* 9/2009 Garcin ..... D9/552 X
- D651,903 S \* 1/2012 Teller ..... D9/521
- D652,309 S \* 1/2012 Hartford ..... D9/544
- D660,162 S \* 5/2012 Baron ..... D9/521
- D661,994 S \* 6/2012 Van Den Wouwer et al. . D9/563
- D683,232 S \* 5/2013 Hulsman ..... D9/564 X

**Related U.S. Application Data**

- (63) Continuation-in-part of application No. 29/392,422, filed on May 20, 2011, now abandoned.
- (51) **LOC (10) Cl.** ..... **09-01**
- (52) **U.S. Cl.**  
USPC ..... **D9/529; D9/564**
- (58) **Field of Classification Search**  
USPC ..... D9/418, 424, 428, 516, 519, 521,  
D9/529-530, 542-544, 549, 551, 564, 575,  
D9/730; 215/379, 381-382, 384; 220/660,  
220/662, 669

See application file for complete search history.

**References Cited**

**U.S. PATENT DOCUMENTS**

- D11,149 S \* 4/1879 Hood ..... D9/521
- D29,171 S \* 8/1898 Packham, Jr. .... D9/521
- D31,892 S \* 11/1899 Downey ..... D24/110
- D33,126 S \* 8/1900 Gurnee ..... D24/110
- 1,104,607 A \* 7/1914 Berger ..... 239/327
- 2,625,292 A \* 1/1953 Spender ..... 220/835
- D214,019 S \* 5/1969 Newman ..... D9/521
- D216,777 S \* 3/1970 Nelson ..... D24/115 X

\* cited by examiner

*Primary Examiner* — Carol P Rademaker

(74) *Attorney, Agent, or Firm* — McAndrews, Held & Malloy, Ltd.

(57) **CLAIM**

The ornamental design for a comestible dispenser, as shown and described.

**DESCRIPTION**

FIG. 1 is top, front, left side perspective view of a comestible dispenser showing my new design;  
 FIG. 2 is a front elevational view thereof;  
 FIG. 3 is a right side elevational view thereof;  
 FIG. 4 is a left side elevational view thereof;  
 FIG. 5 is a top plan view thereof; and,  
 FIG. 6 is a bottom plan view thereof.  
 The broken line shown on the bottom surface in the FIG. 6 drawing view is included for the purpose of illustrating environmental structure and forms no part of the claimed design.

**1 Claim, 3 Drawing Sheets**

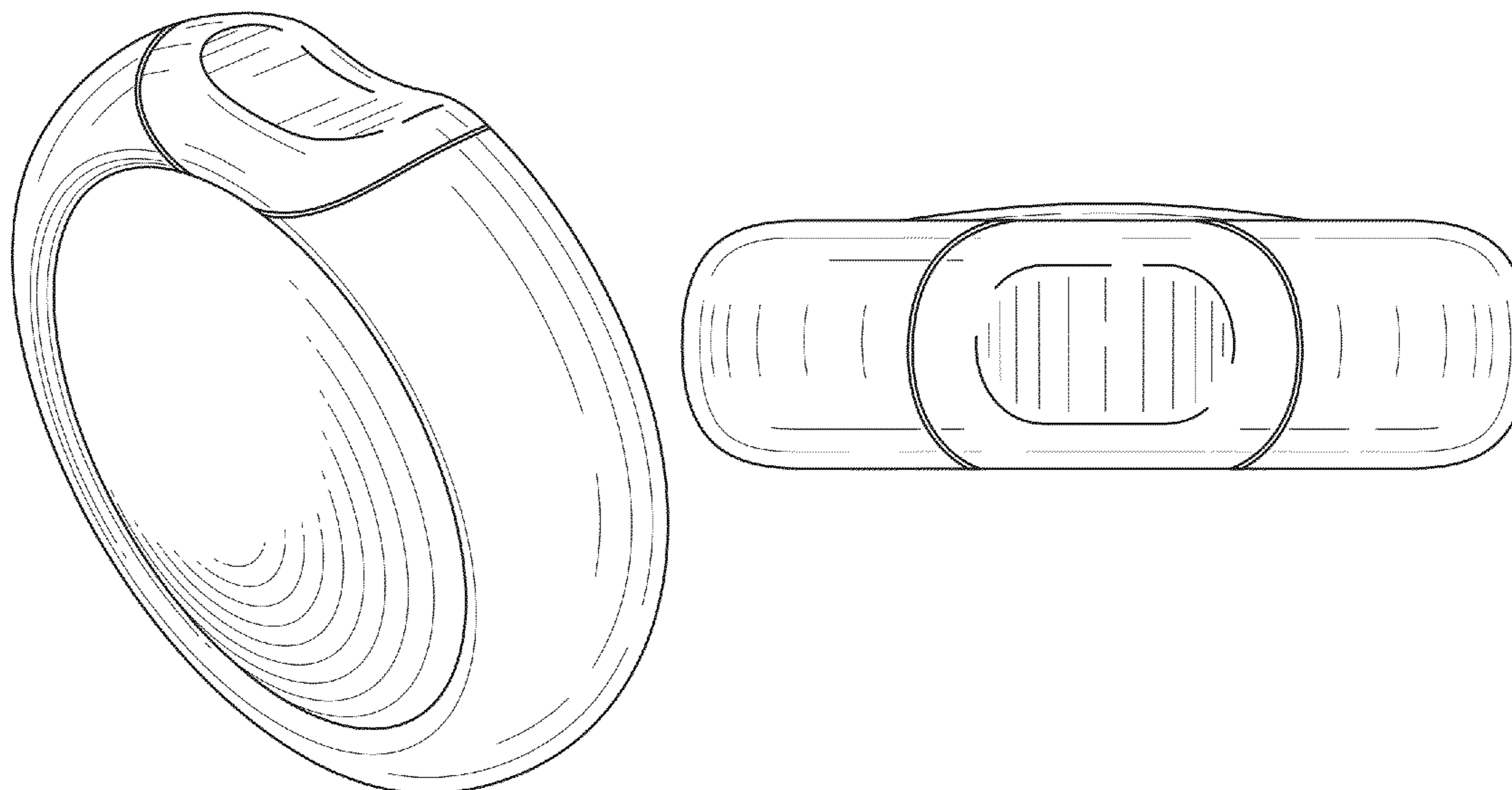

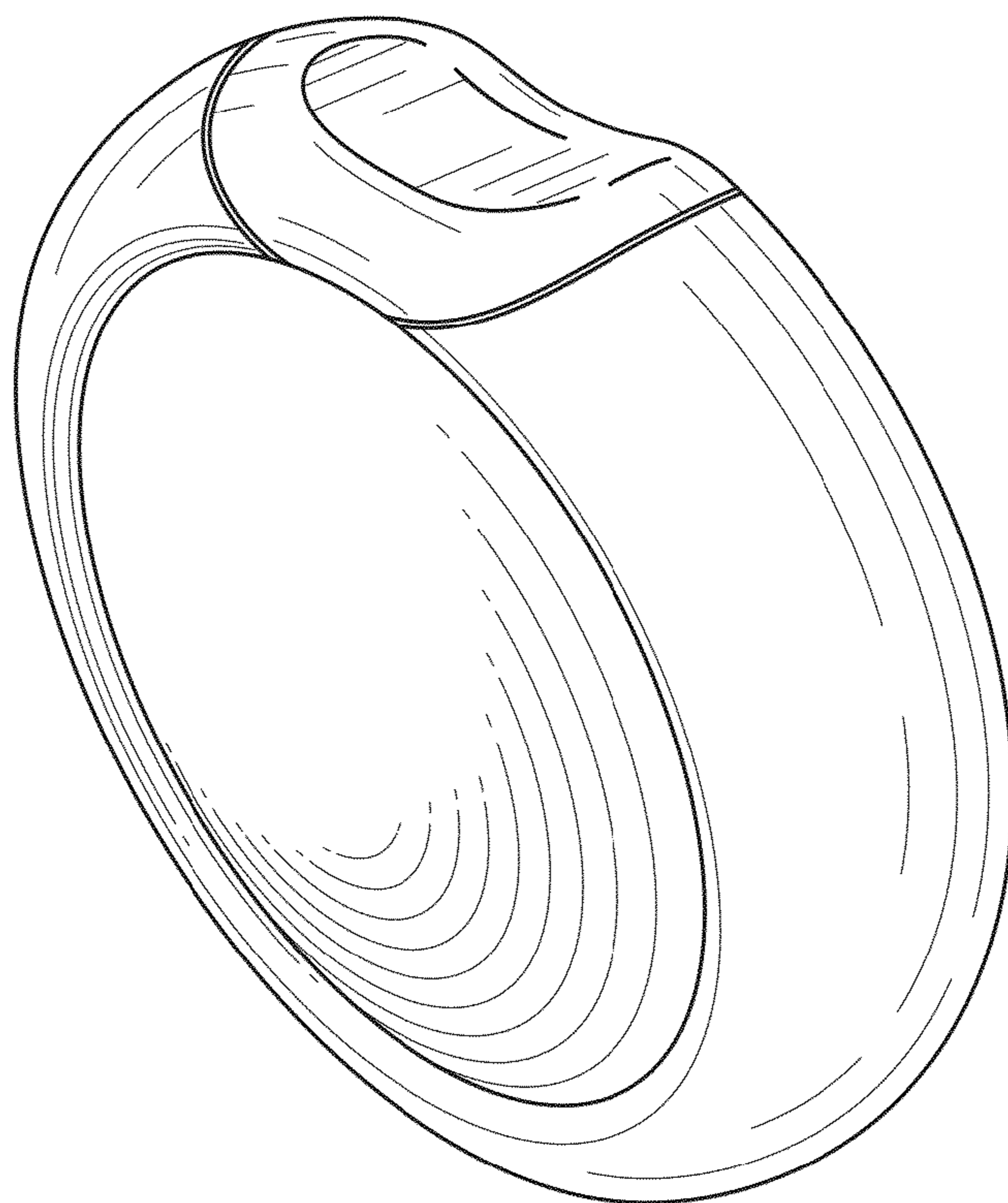

FIG. 1

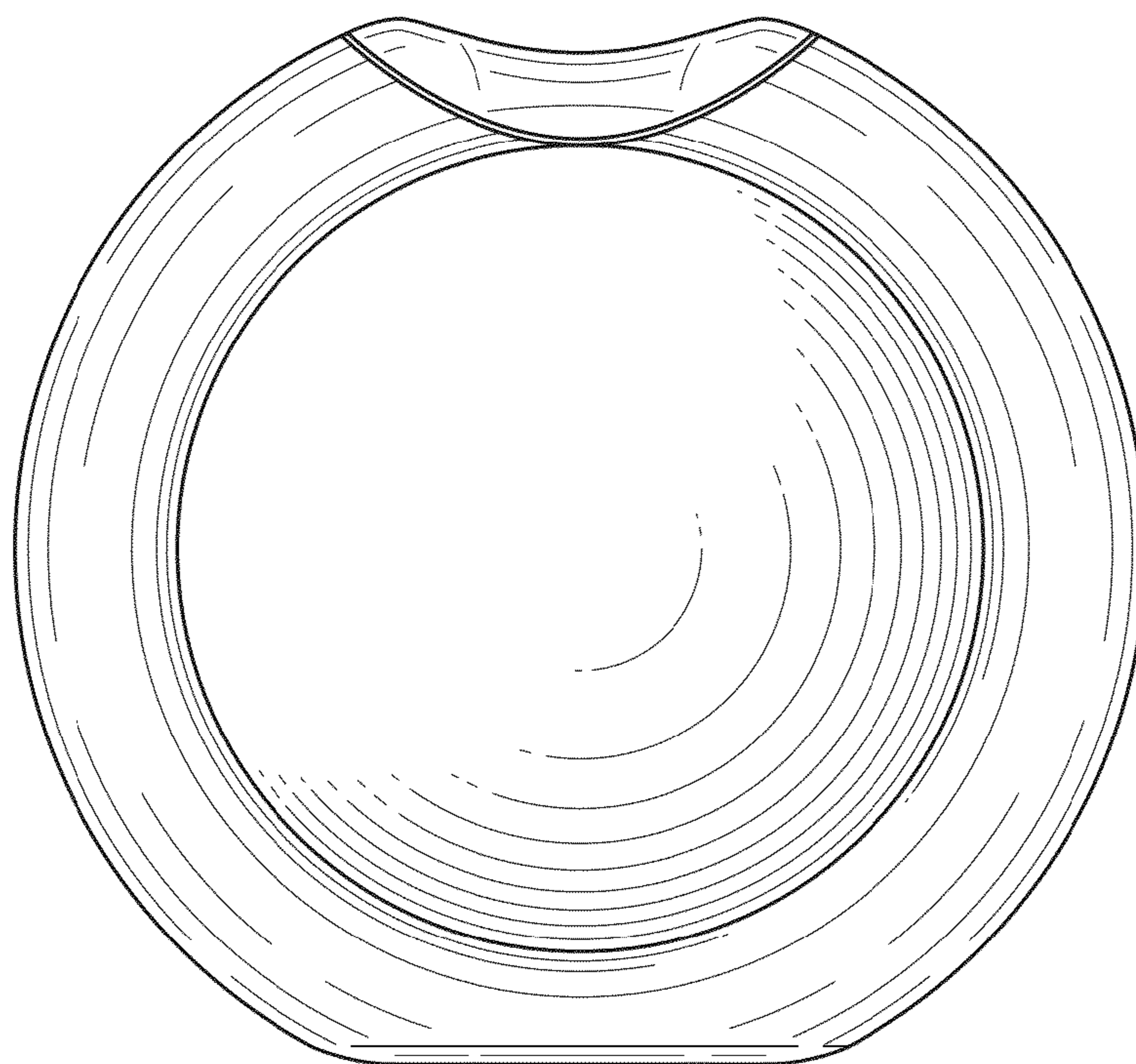

FIG. 2

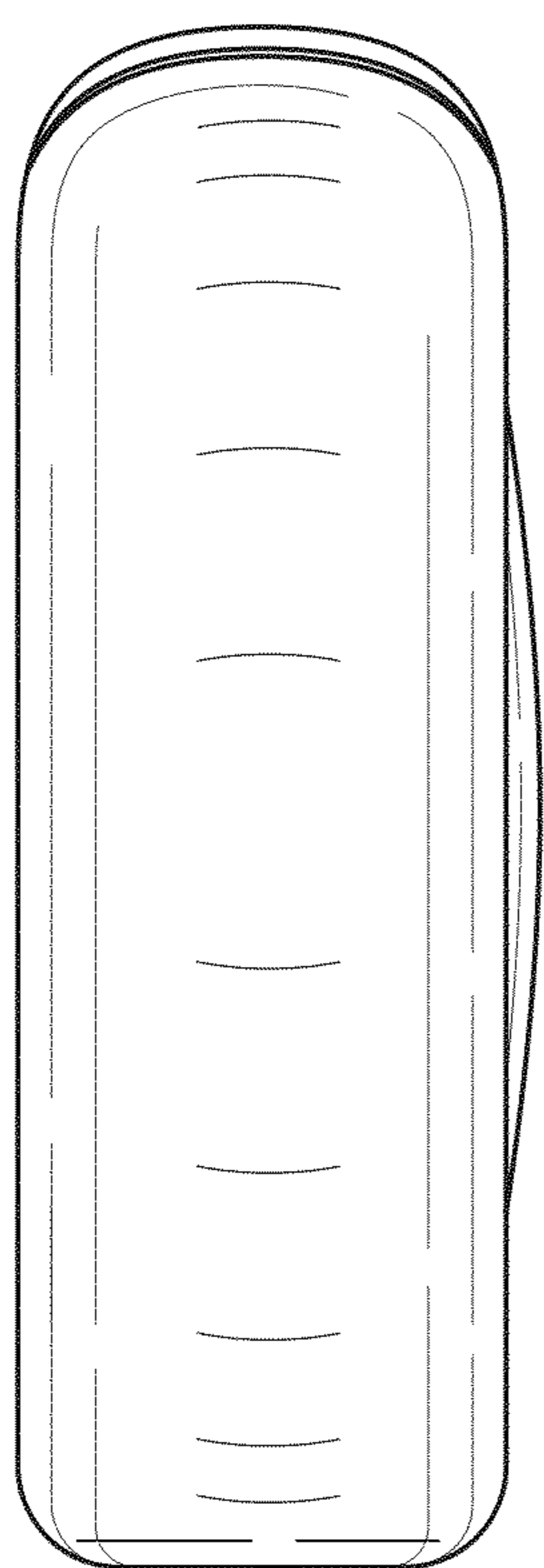

FIG. 3

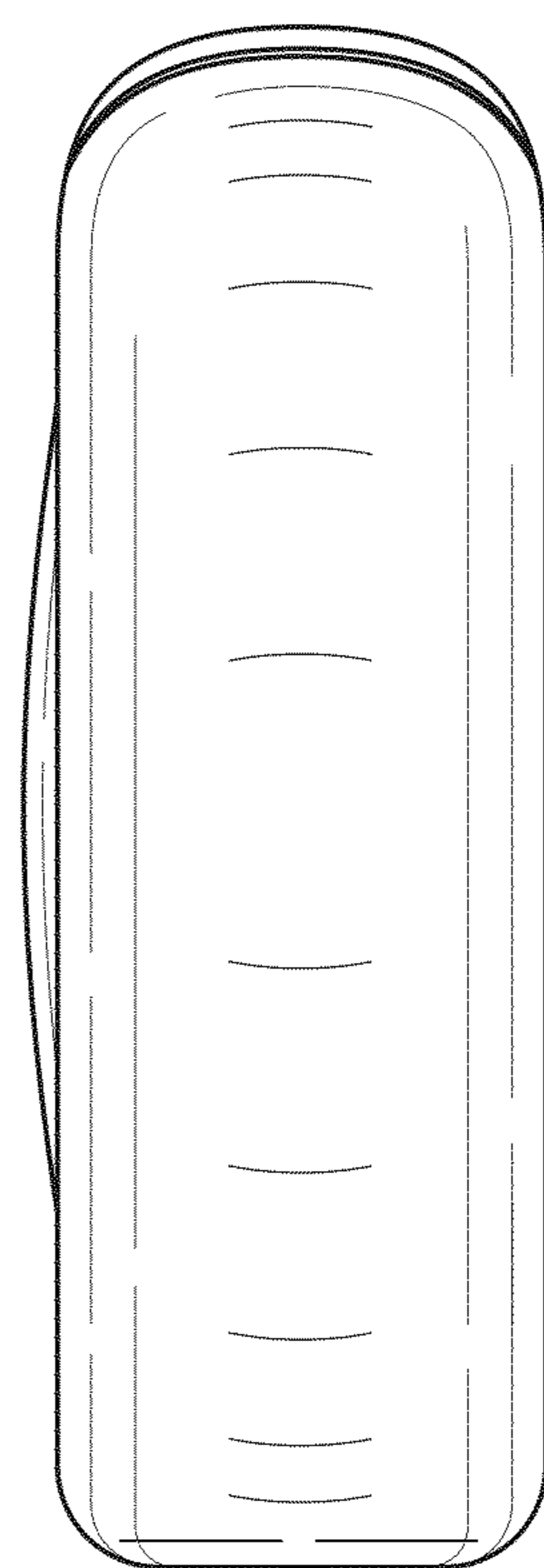

FIG. 4



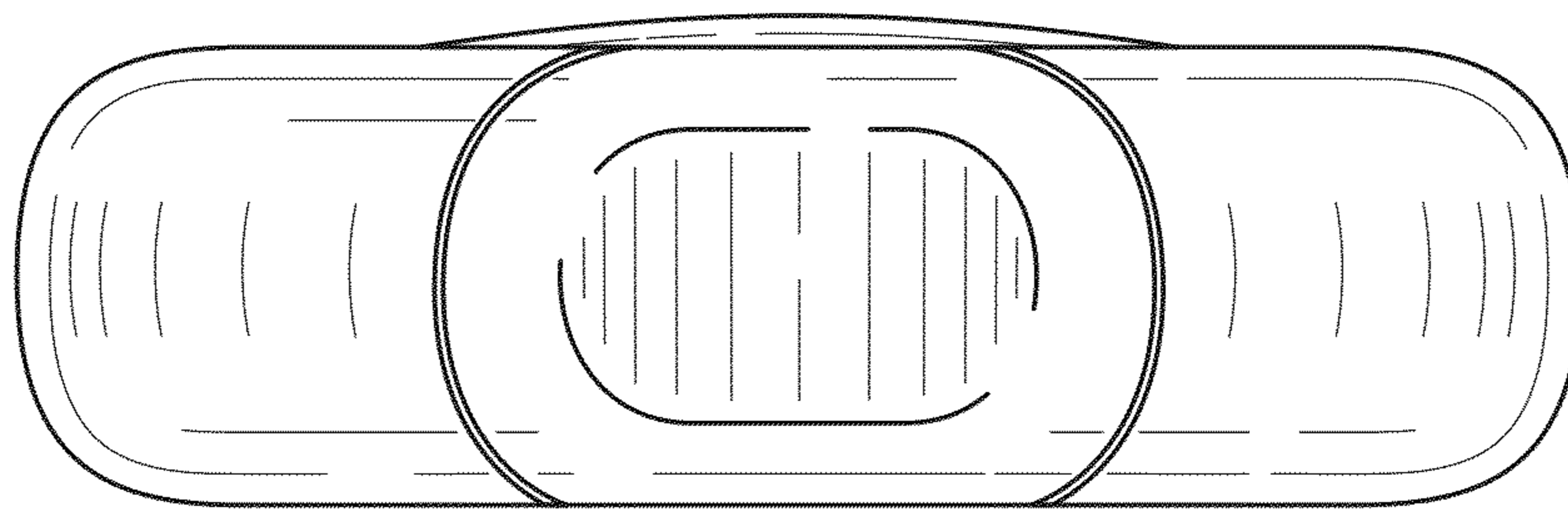

FIG. 5

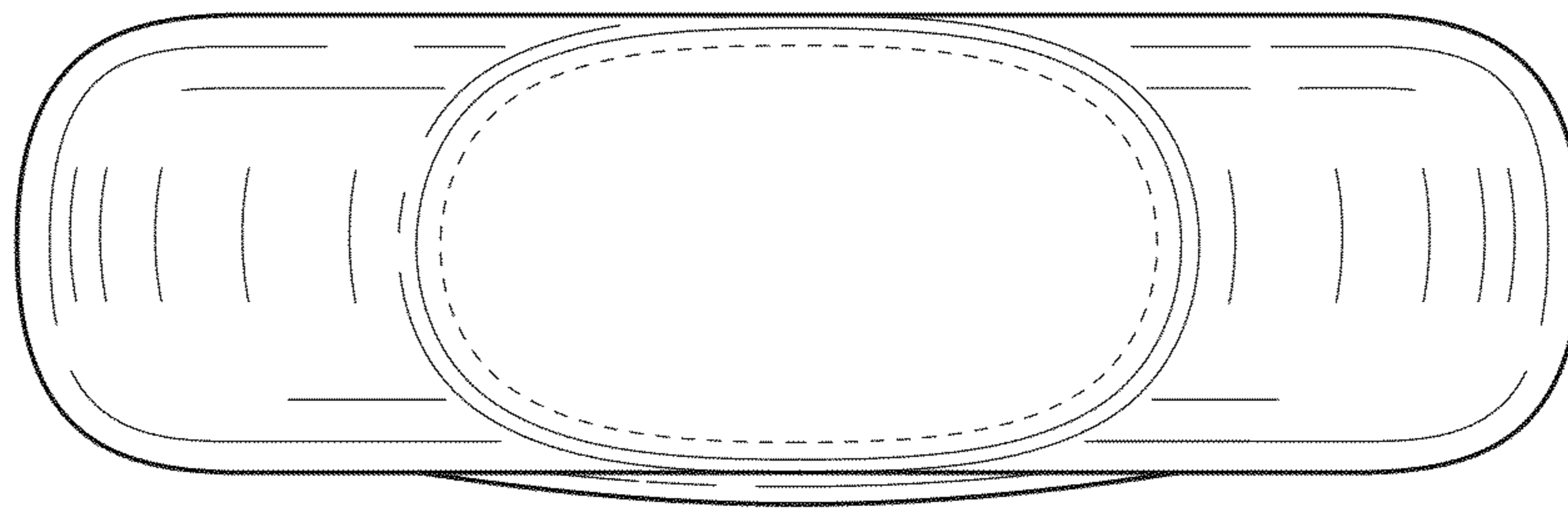

FIG. 6