



US00D707944S

(12) **United States Design Patent**
Spring

(10) **Patent No.:** **US D707,944 S**

(45) **Date of Patent:** **** Jul. 1, 2014**

(54) **FOOTWEAR**

(75) Inventor: **Angie Spring**, Portland, OR (US)

(73) Assignee: **Sorel Corporation**, Portland, OR (US)

(**) Term: **14 Years**

(21) Appl. No.: **29/420,618**

(22) Filed: **May 10, 2012**

(51) **LOC (10) Cl.** **02-99**

(52) **U.S. Cl.**
USPC **D2/971**

(58) **Field of Classification Search**
USPC D2/896, 910, 911, 925-942, 946, 969;
36/1, 83, 3 A, 8.3, 45-58, 104, 108,
36/76 R
See application file for complete search history.

(56) **References Cited**

U.S. PATENT DOCUMENTS

D91,483 S *	2/1934	Ellington	D2/932
D99,058 S *	3/1936	Troy	D2/929
D103,138 S *	2/1937	Weiner	D2/934
D106,775 S *	11/1937	Sholtz	D2/940
D107,859 S *	1/1938	Ferragamo	D2/927

D113,405 S *	2/1939	Troy	D2/940
D127,119 S *	5/1941	Wood	D2/928
D127,531 S *	5/1941	Wolock	D2/940
D586,109 S *	2/2009	Andersen et al.	D2/970
D673,762 S *	1/2013	Spring	D2/911

* cited by examiner

Primary Examiner — Dominic Simone

(74) *Attorney, Agent, or Firm* — Schwabe, Williamson & Wyatt

(57) **CLAIM**

I claim the ornamental design for footwear, as shown and described.

DESCRIPTION

FIG. 1 is a perspective view of footwear, showing my new design;
FIG. 2 is a right side view thereof;
FIG. 3 is a left side view thereof;
FIG. 4 is a top view thereof;
FIG. 5 is a bottom view thereof;
FIG. 6 is a front view thereof; and,
FIG. 7 is a back view thereof.
The dashed lines are included for illustrating environmental structure and form no part of the claimed design.

1 Claim, 5 Drawing Sheets

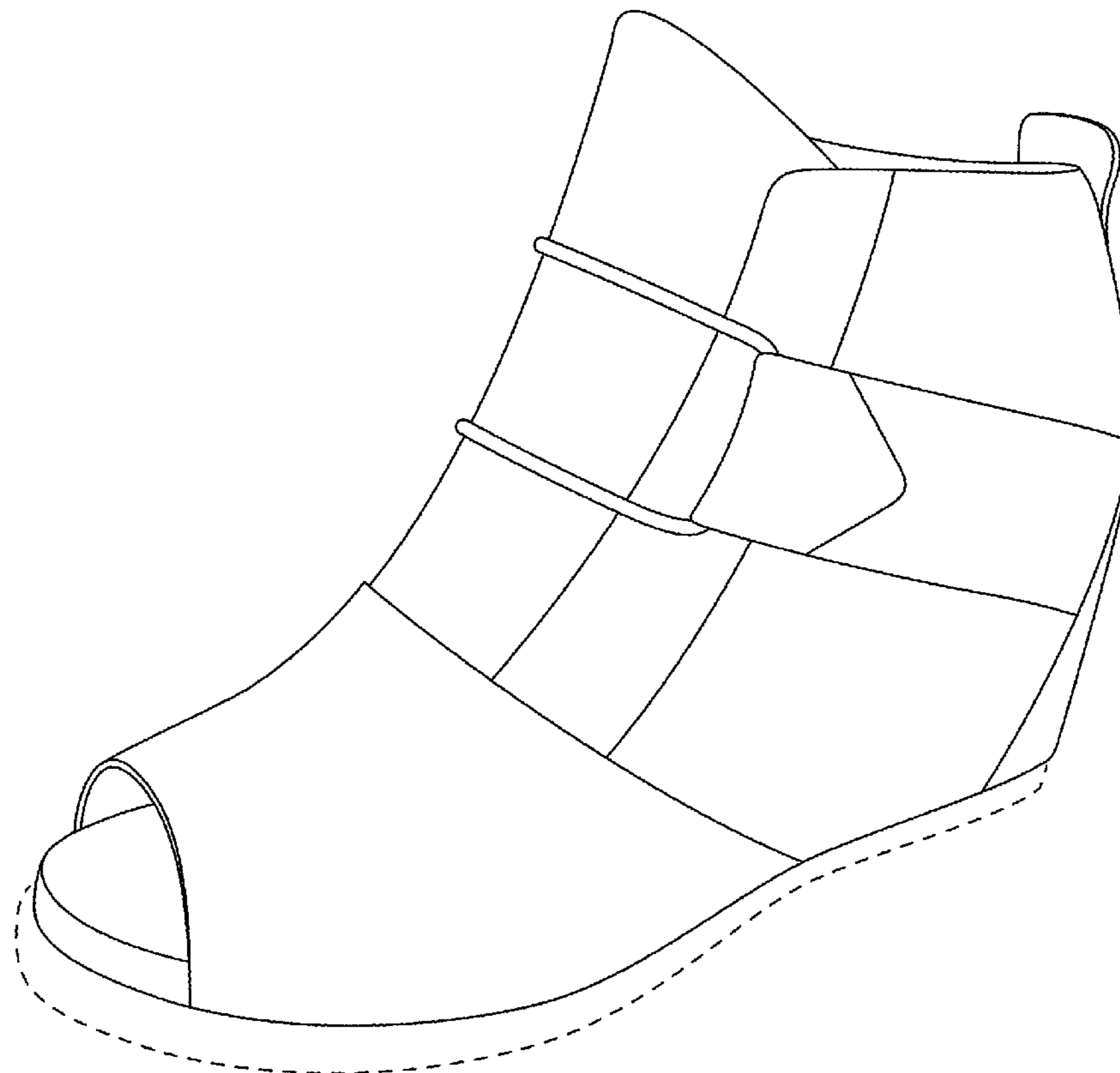

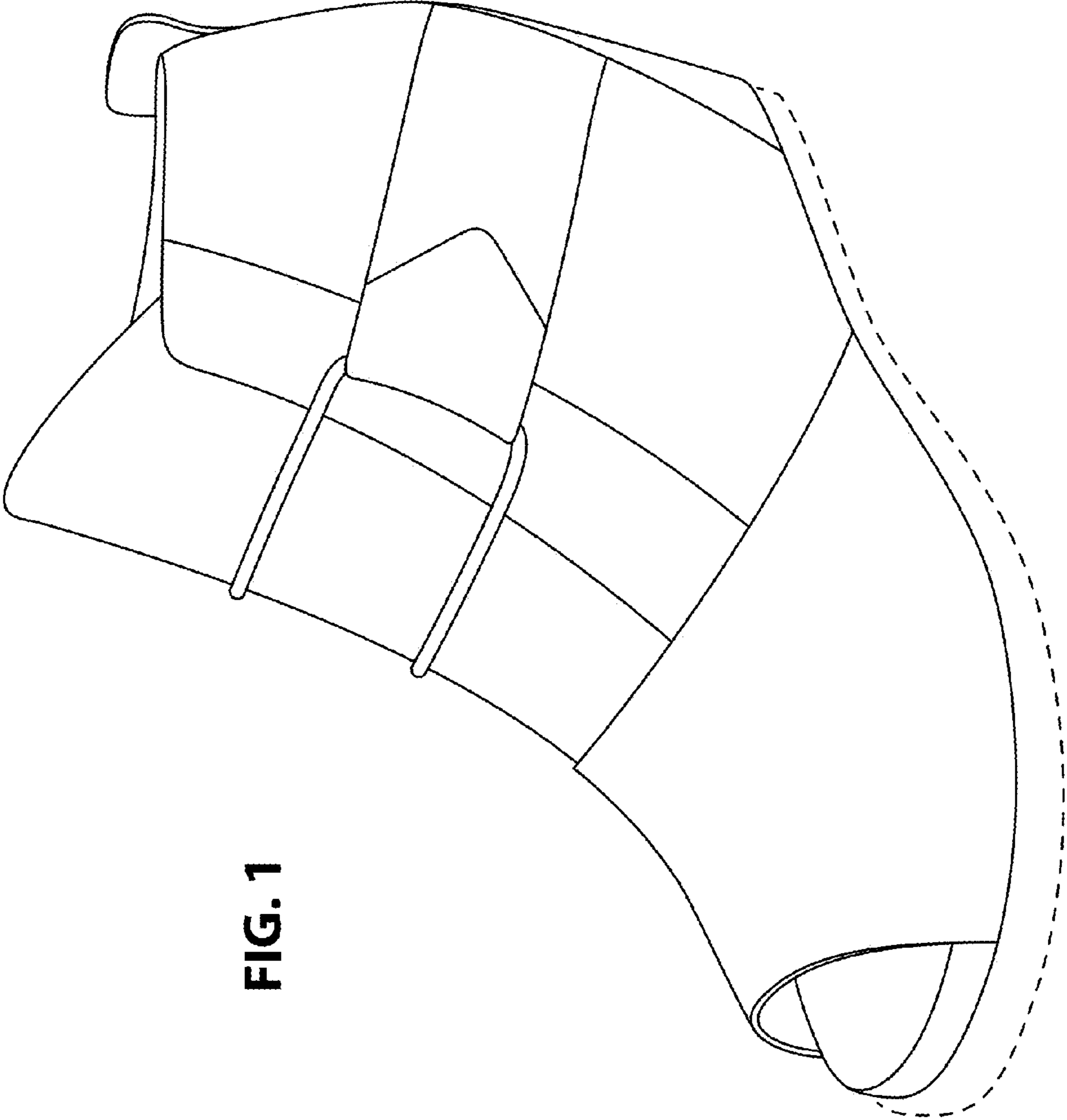

FIG. 1

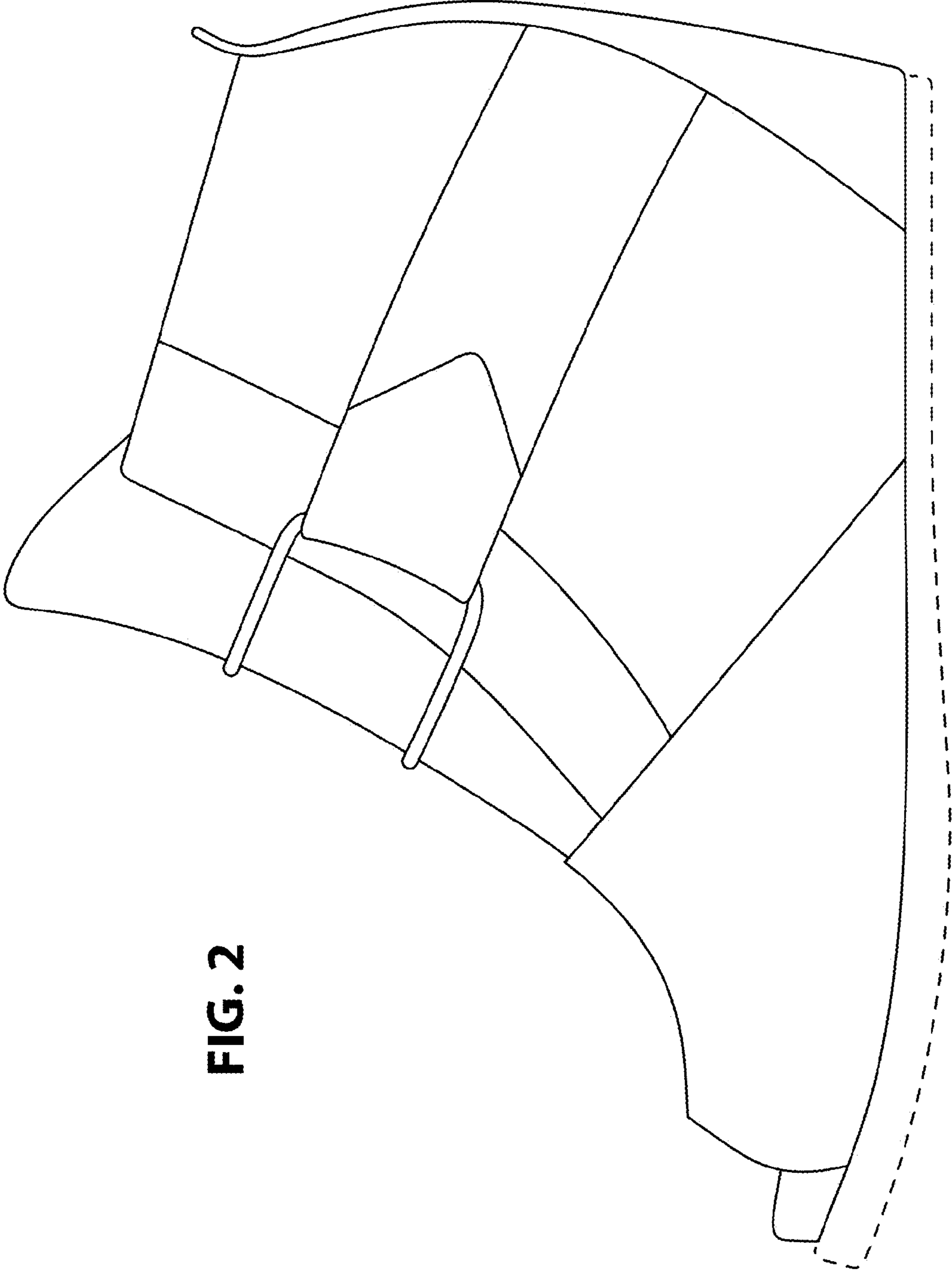
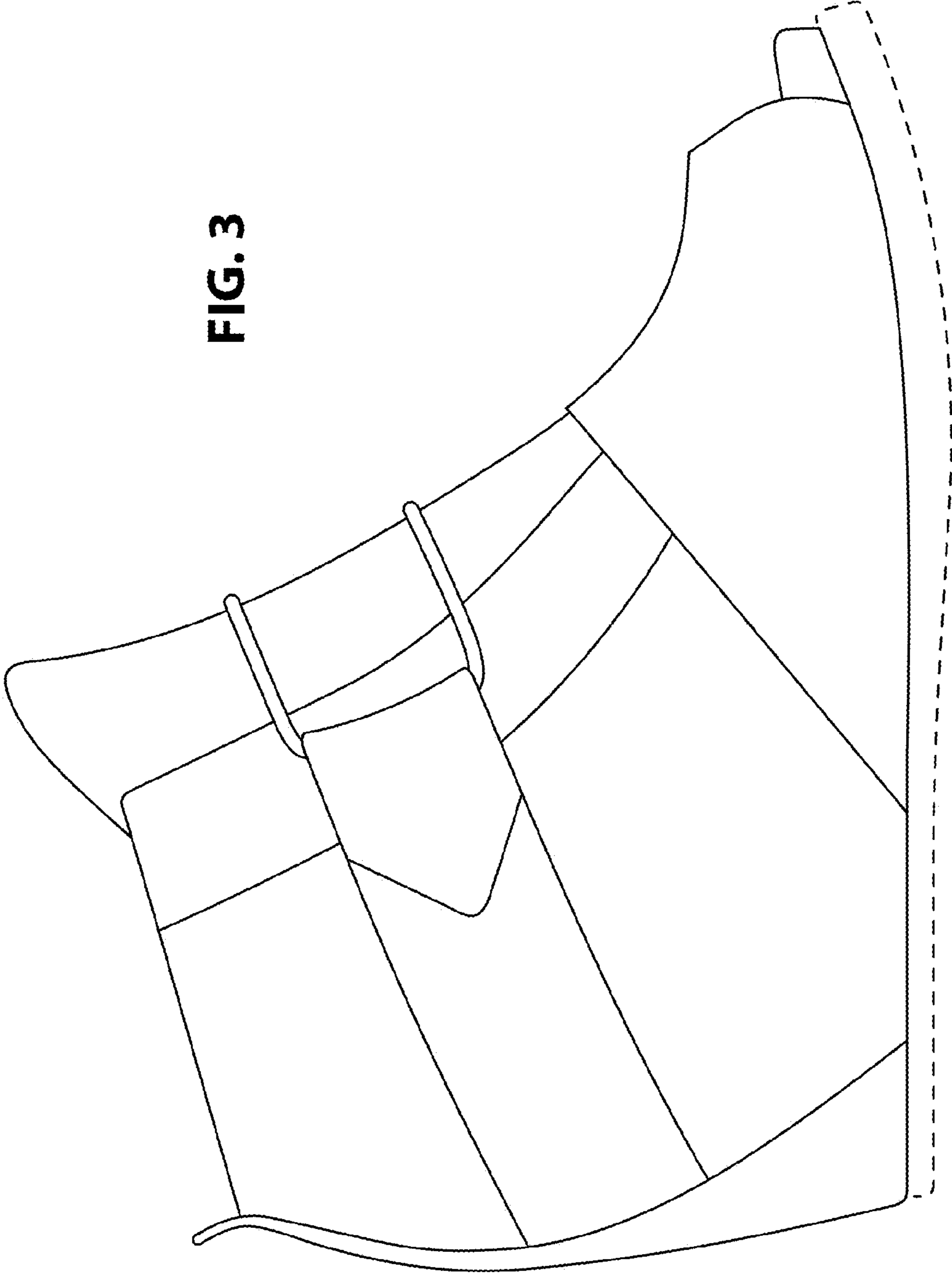

FIG. 2

FIG. 3



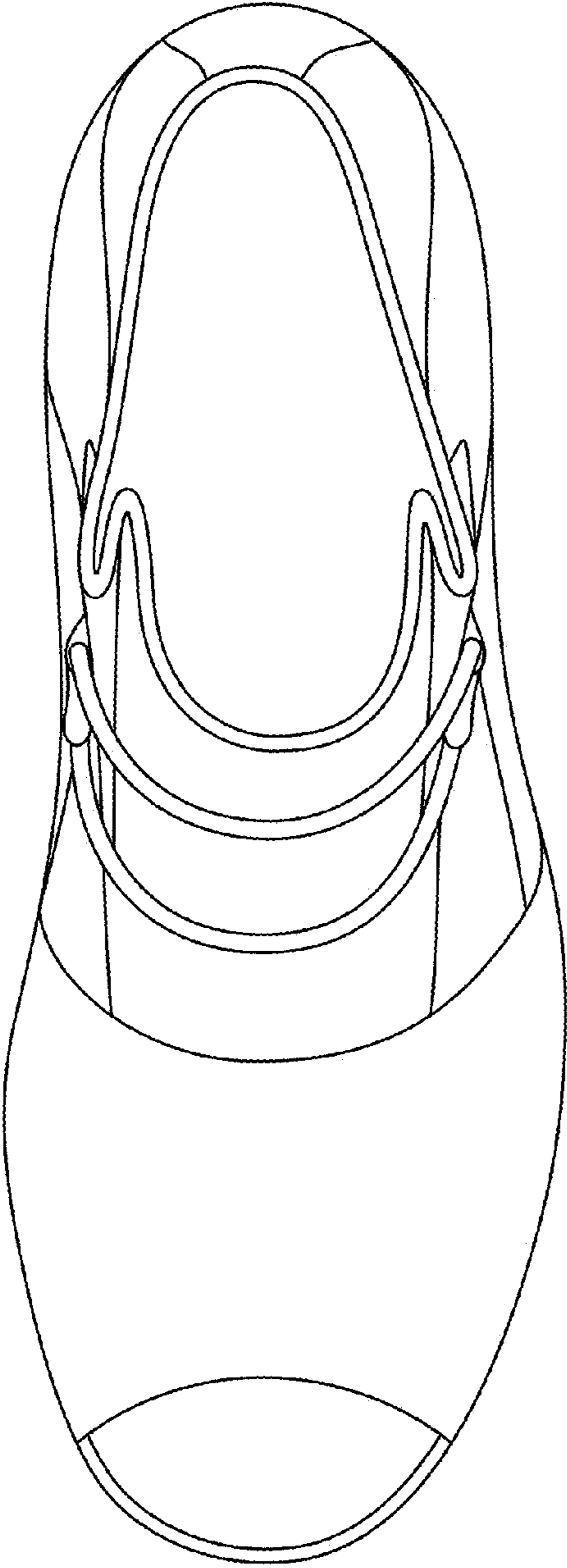

FIG. 4

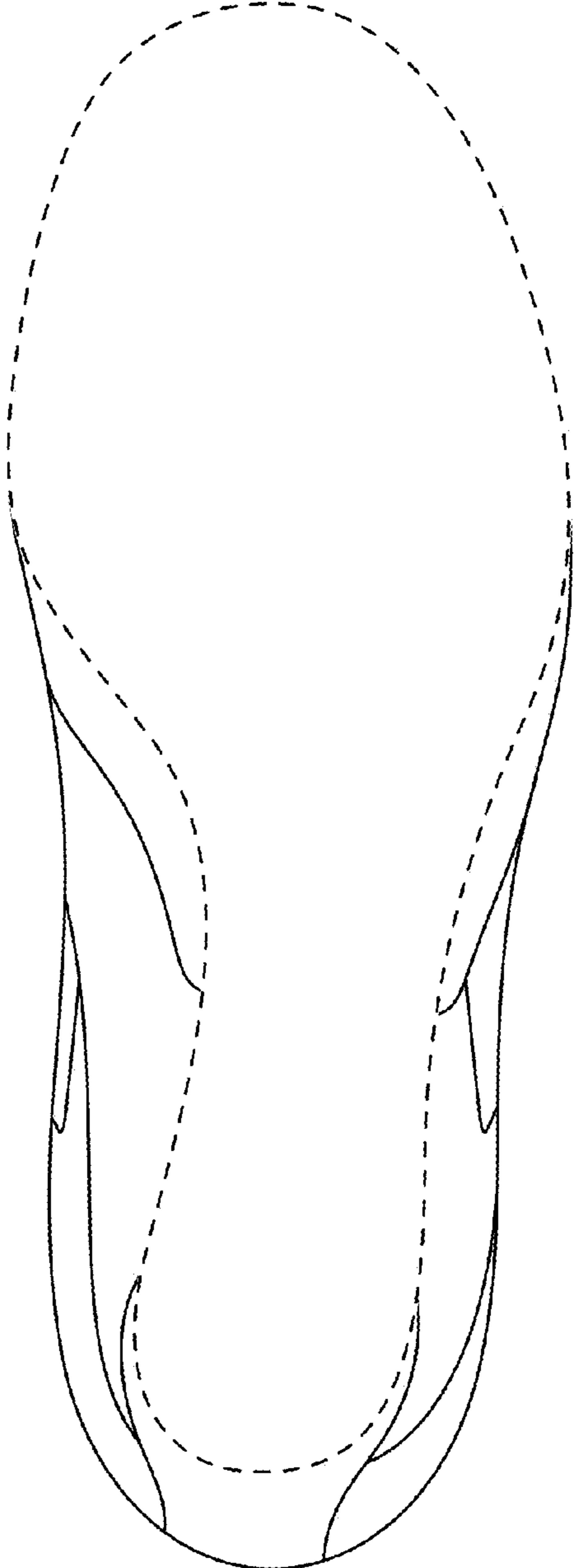

FIG. 5

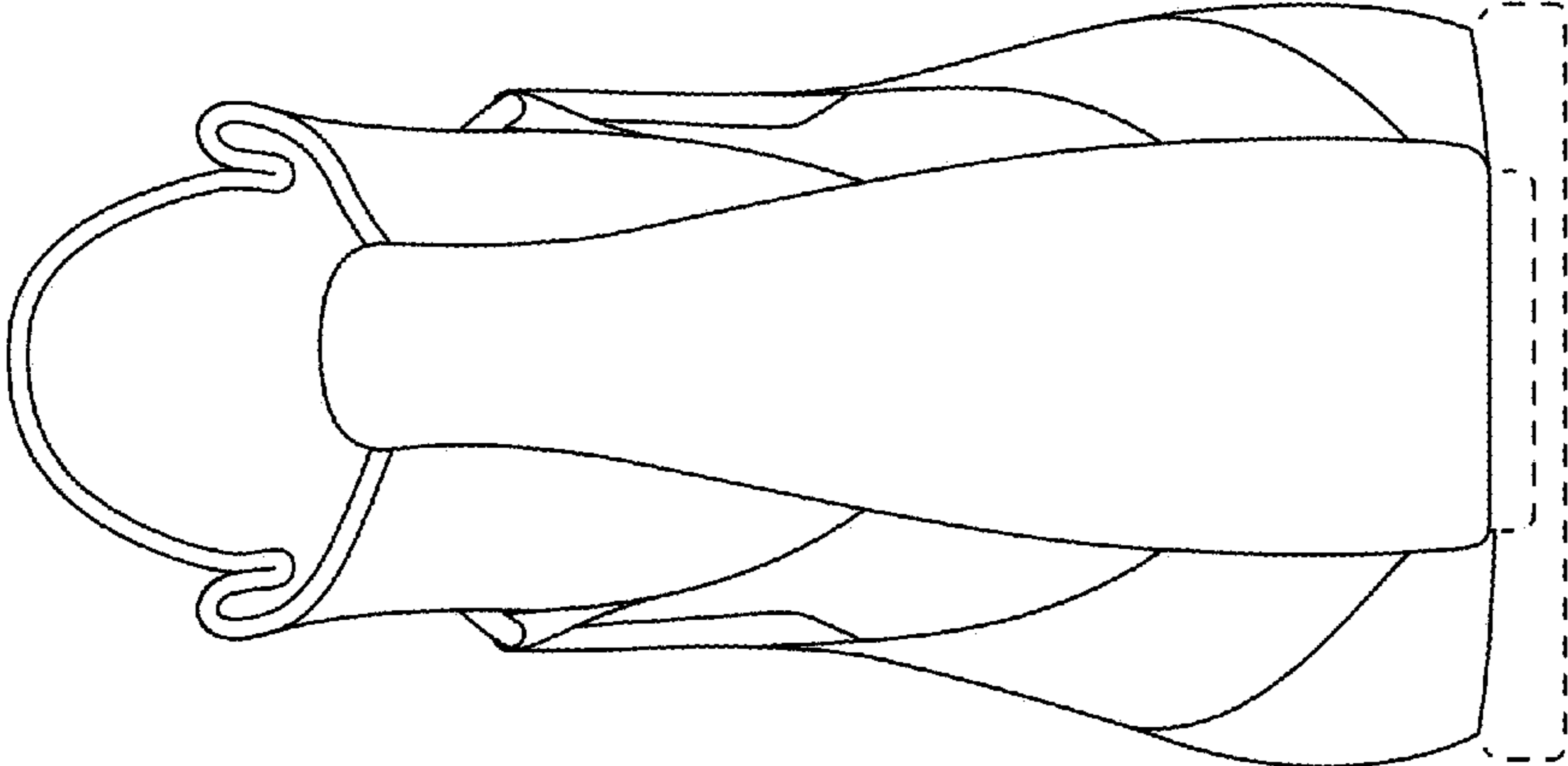

FIG. 7

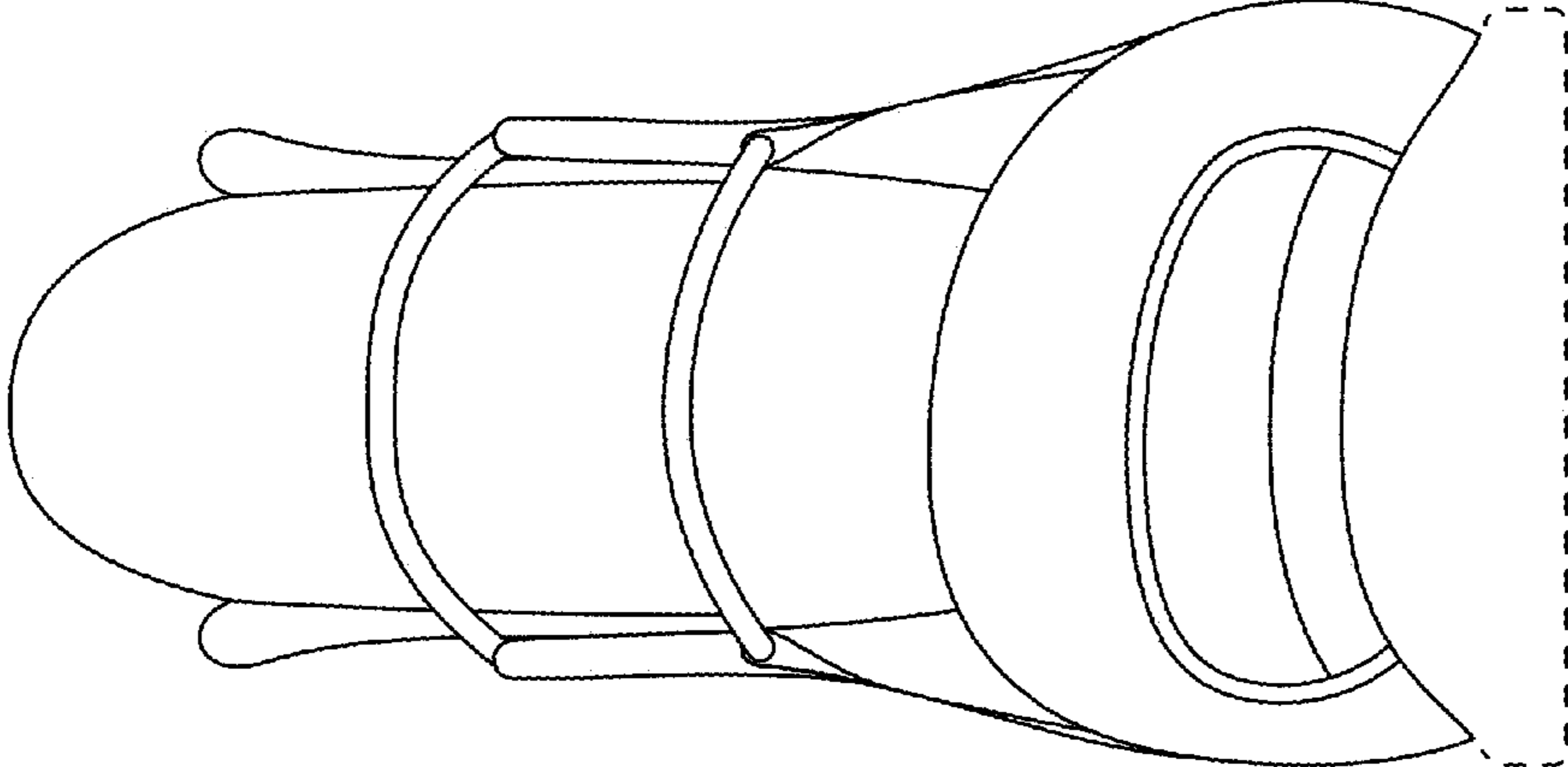

FIG. 6