



US00D707943S

(12) **United States Design Patent**  
**Nascimento**

(10) **Patent No.:** **US D707,943 S**

(45) **Date of Patent:** **\*\* Jul. 1, 2014**

(54) **FOOTWEAR**

(75) Inventor: **Christopher Nascimento**, Portland, OR  
(US)

(73) Assignee: **Columbia Sportswear North America, Inc.**, Portland, OR (US)

(\*\*) Term: **14 Years**

(21) Appl. No.: **29/420,631**

(22) Filed: **May 10, 2012**

(51) **LOC (10) Cl.** ..... **02-99**

(52) **U.S. Cl.**  
USPC ..... **D2/969**

(58) **Field of Classification Search**

USPC ..... D2/902, 903, 906-908, 946, 969,  
D2/972-974; 36/45, 50.1, 77 M, 77 R, 83,  
36/88, 113, 114, 126-131

See application file for complete search history.

(56) **References Cited**

**U.S. PATENT DOCUMENTS**

D393,938 S \* 5/1998 Genuin ..... D2/906  
D458,015 S \* 6/2002 Dolan et al. .... D2/972  
D460,251 S \* 7/2002 Dolan ..... D2/972  
D487,336 S \* 3/2004 Matis ..... D2/969

D499,875 S \* 12/2004 Lozano ..... D2/972  
D517,298 S \* 3/2006 James ..... D2/969  
D578,294 S \* 10/2008 Mervar et al. .... D2/969  
D579,186 S \* 10/2008 Mervar et al. .... D2/969  
D598,190 S \* 8/2009 Weber ..... D2/969  
D648,110 S \* 11/2011 Rasmussen ..... D2/972

\* cited by examiner

*Primary Examiner* — Dominic Simone

(74) *Attorney, Agent, or Firm* — Schwabe, Williamson & Wyatt

(57) **CLAIM**

I claim the ornamental design for footwear, as shown and described.

**DESCRIPTION**

FIG. 1 is a perspective view of footwear, showing my new design;

FIG. 2 is a front view thereof;

FIG. 3 is a back view thereof;

FIG. 4 is a left side view thereof;

FIG. 5 is a right side view thereof;

FIG. 6 is a top view thereof; and,

FIG. 7 is a bottom view thereof.

The dashed lines are included for illustrating environmental structure and form no part of the claimed design.

**1 Claim, 6 Drawing Sheets**

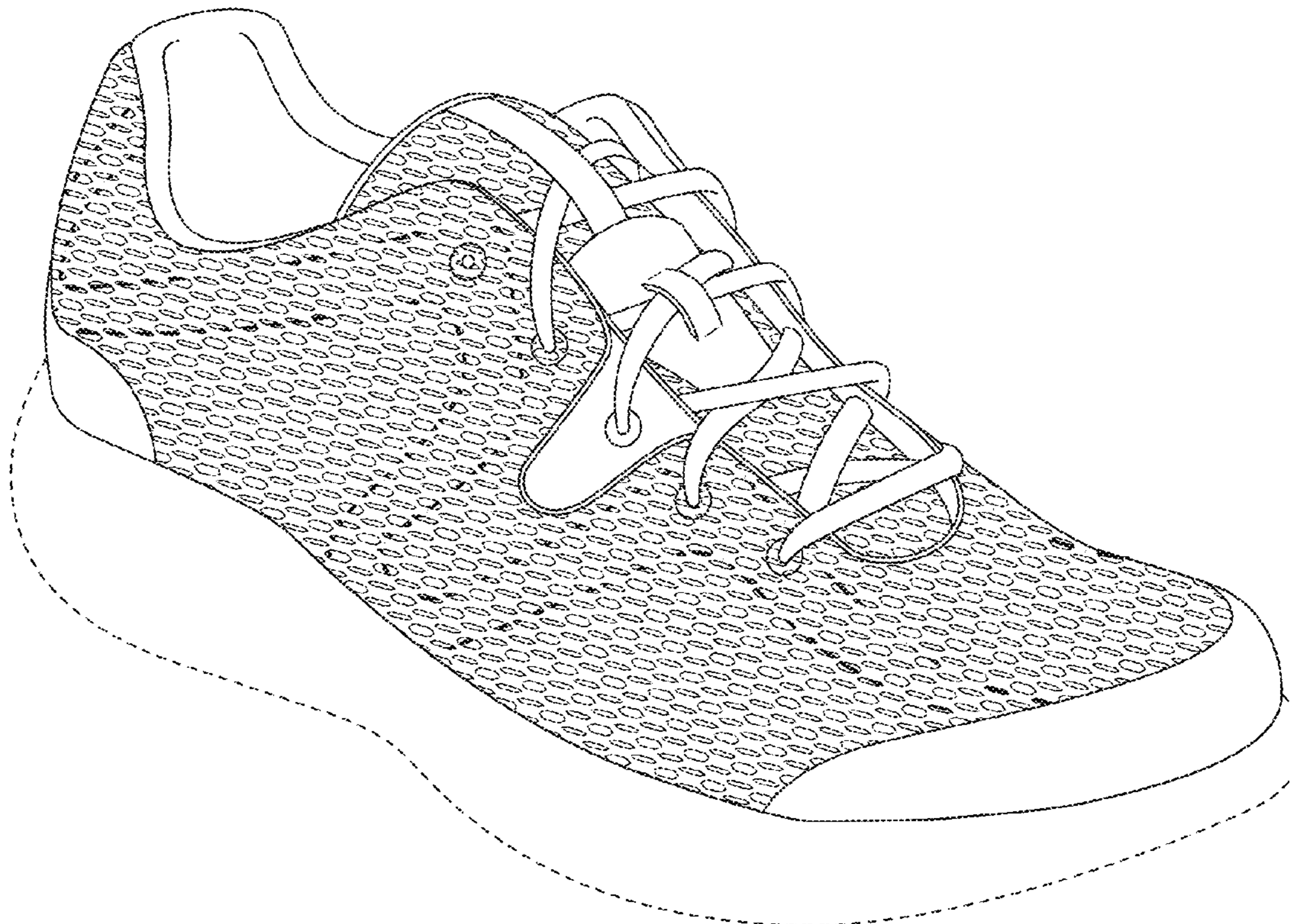

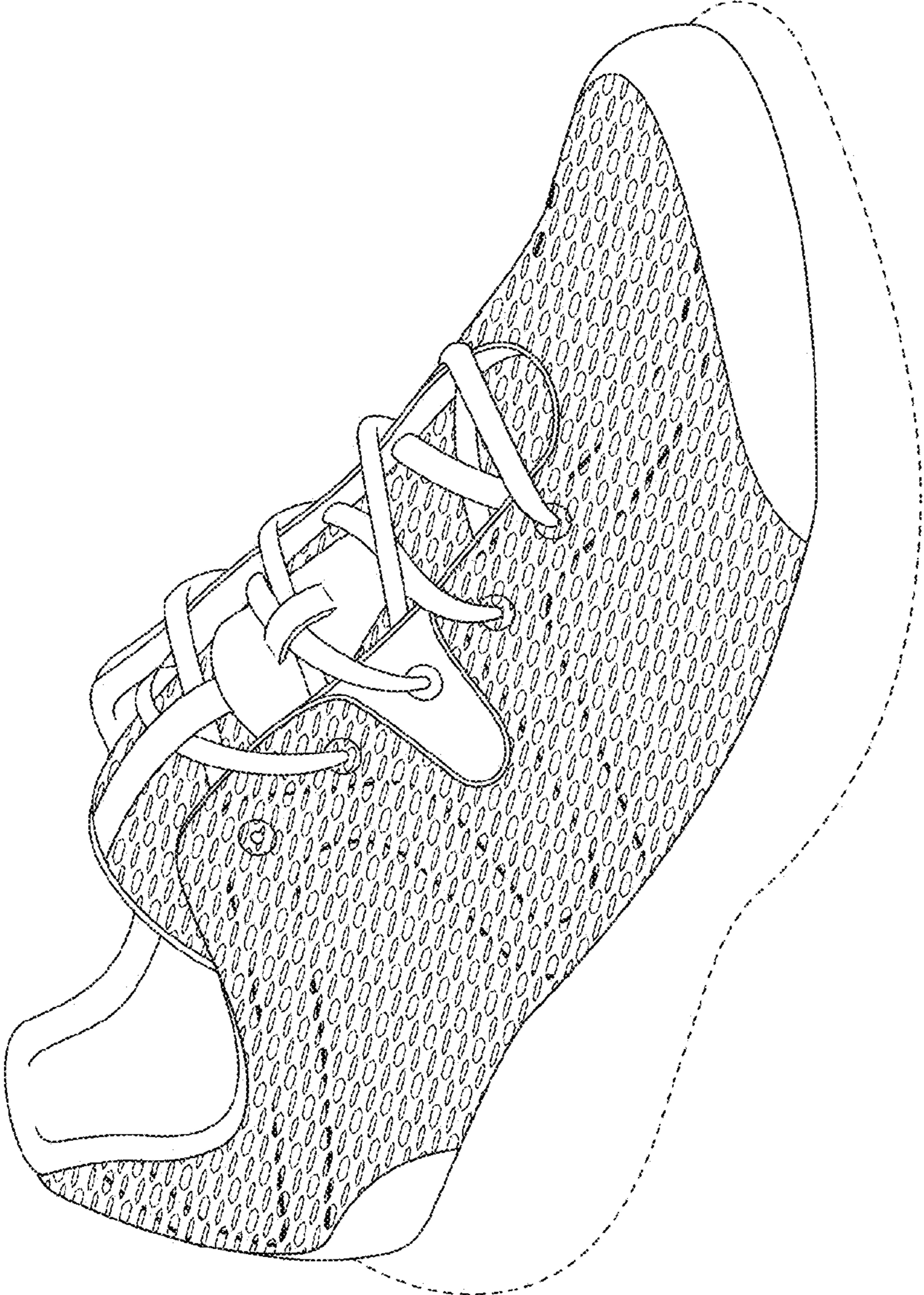

FIG. 1

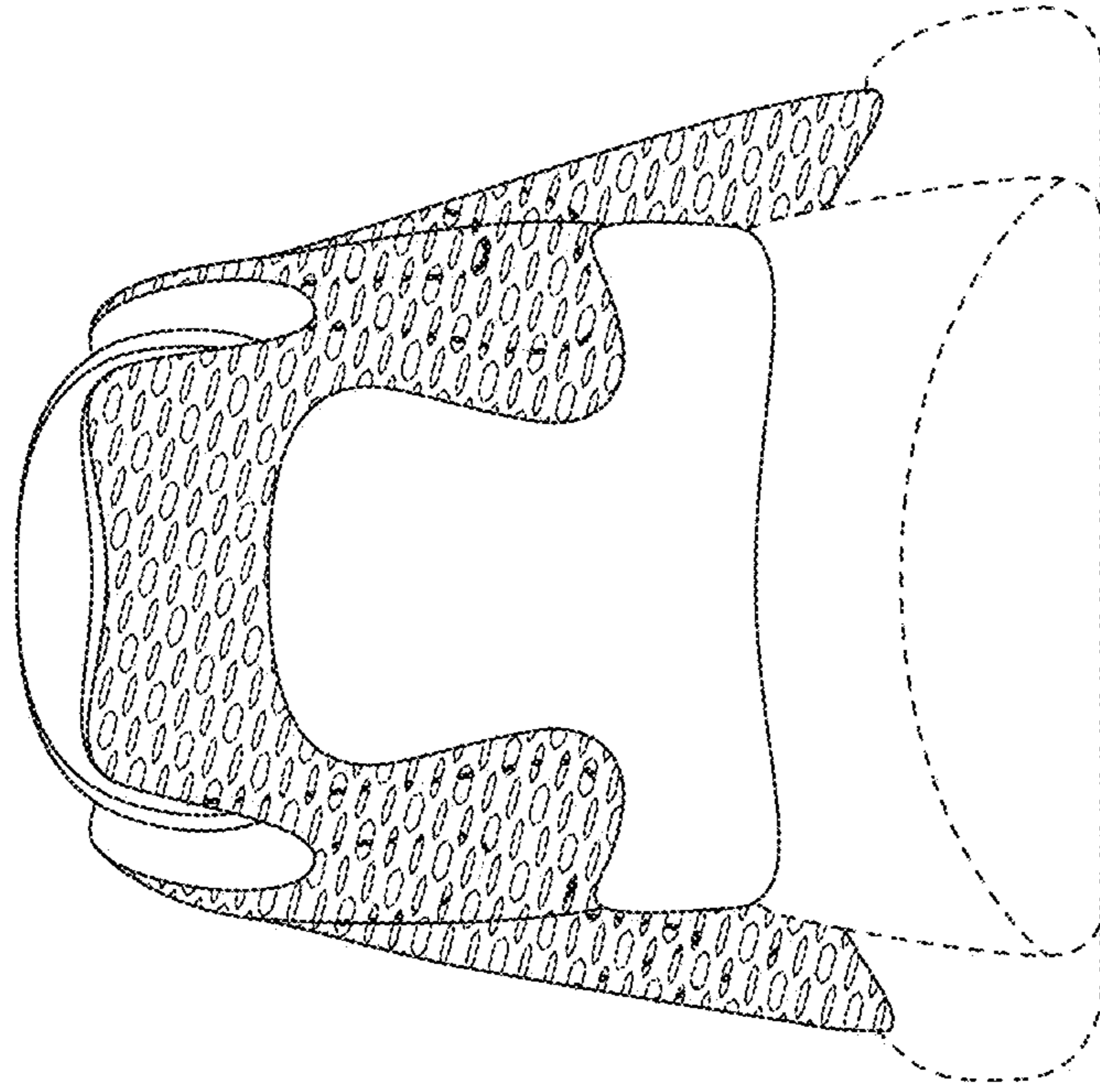

FIG. 3

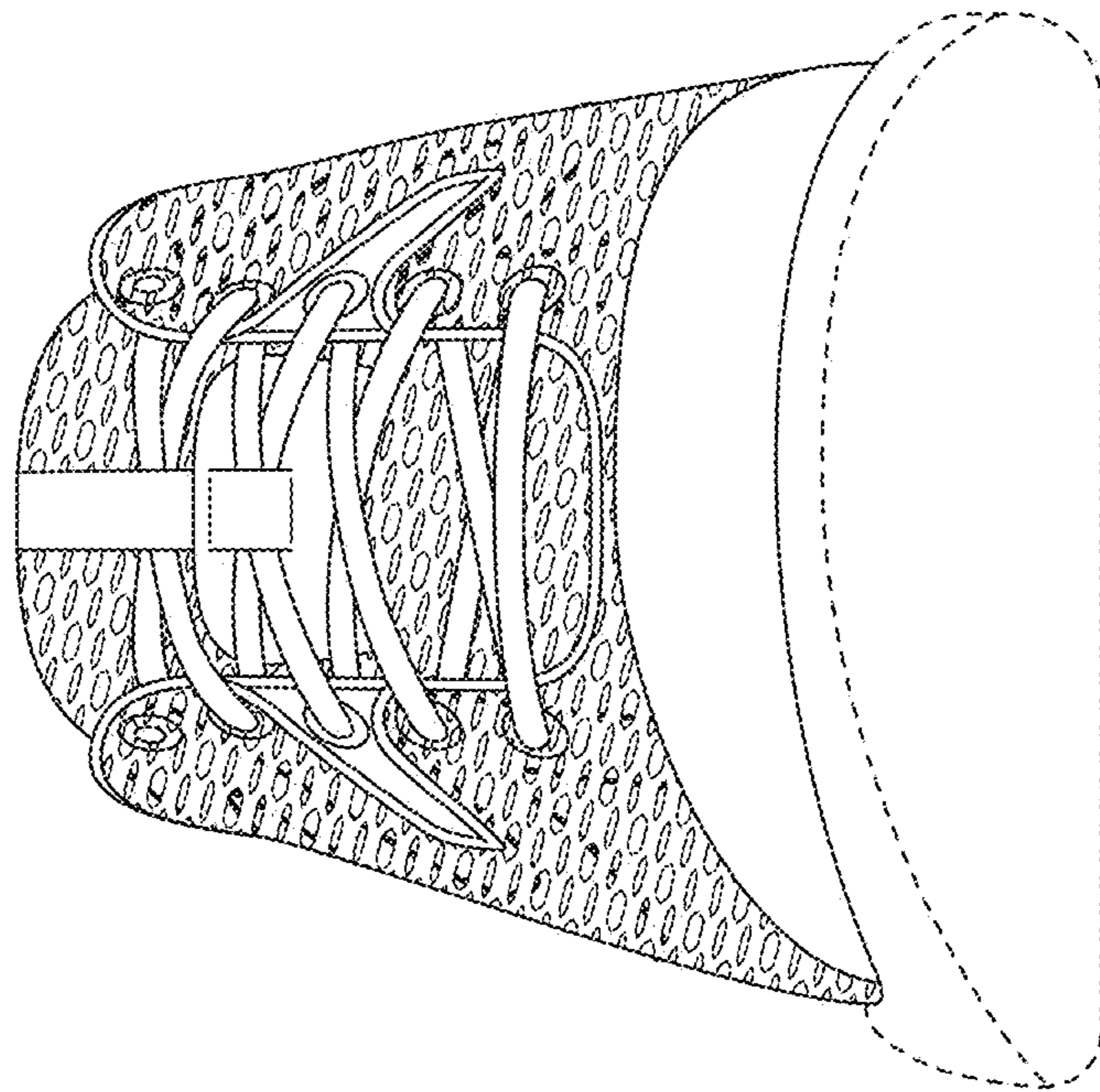

FIG. 2

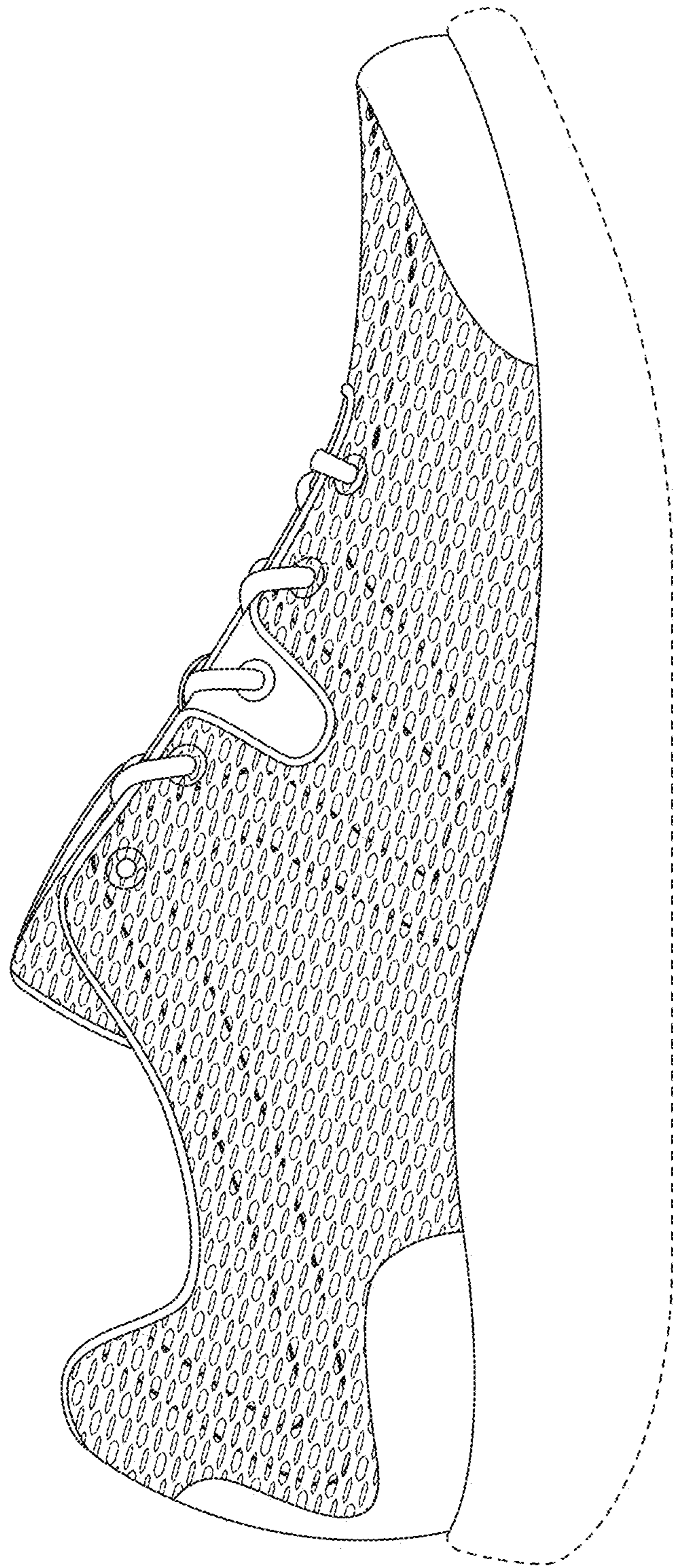

FIG. 4

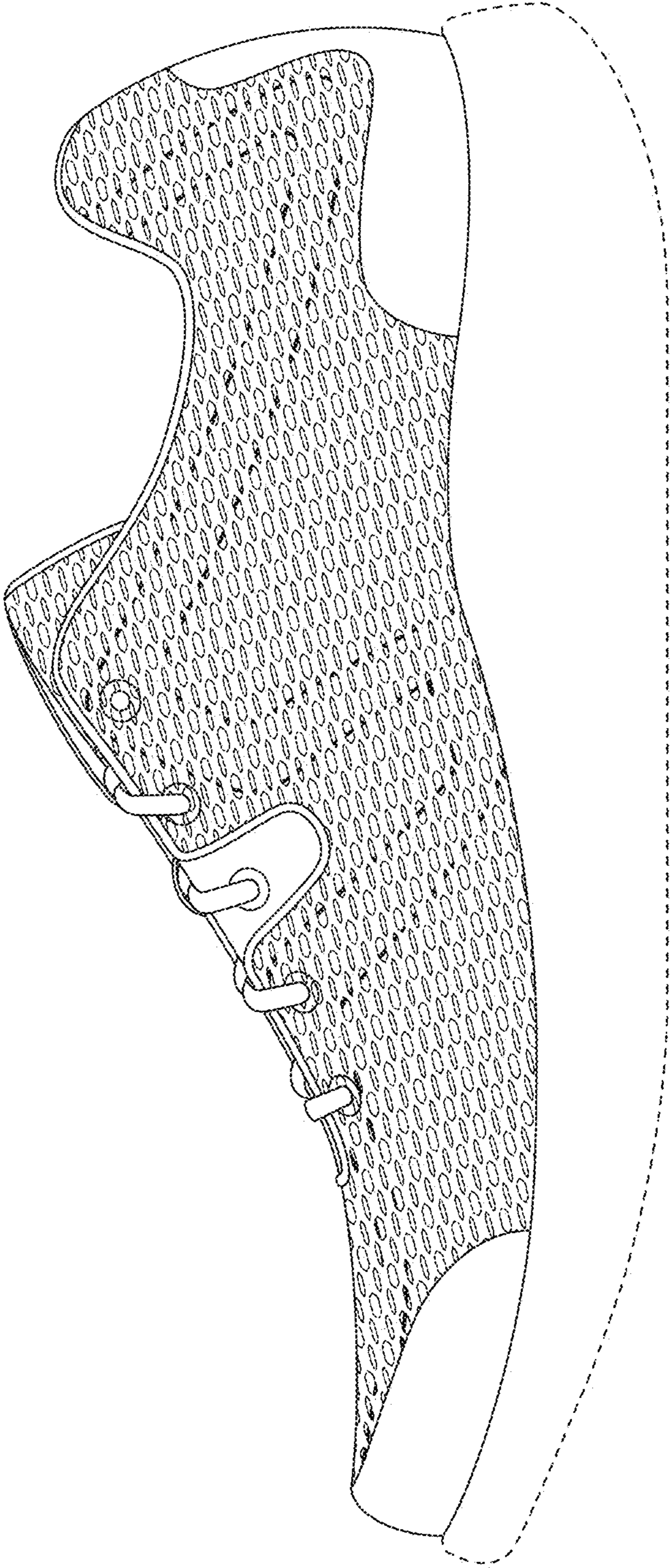

FIG. 5

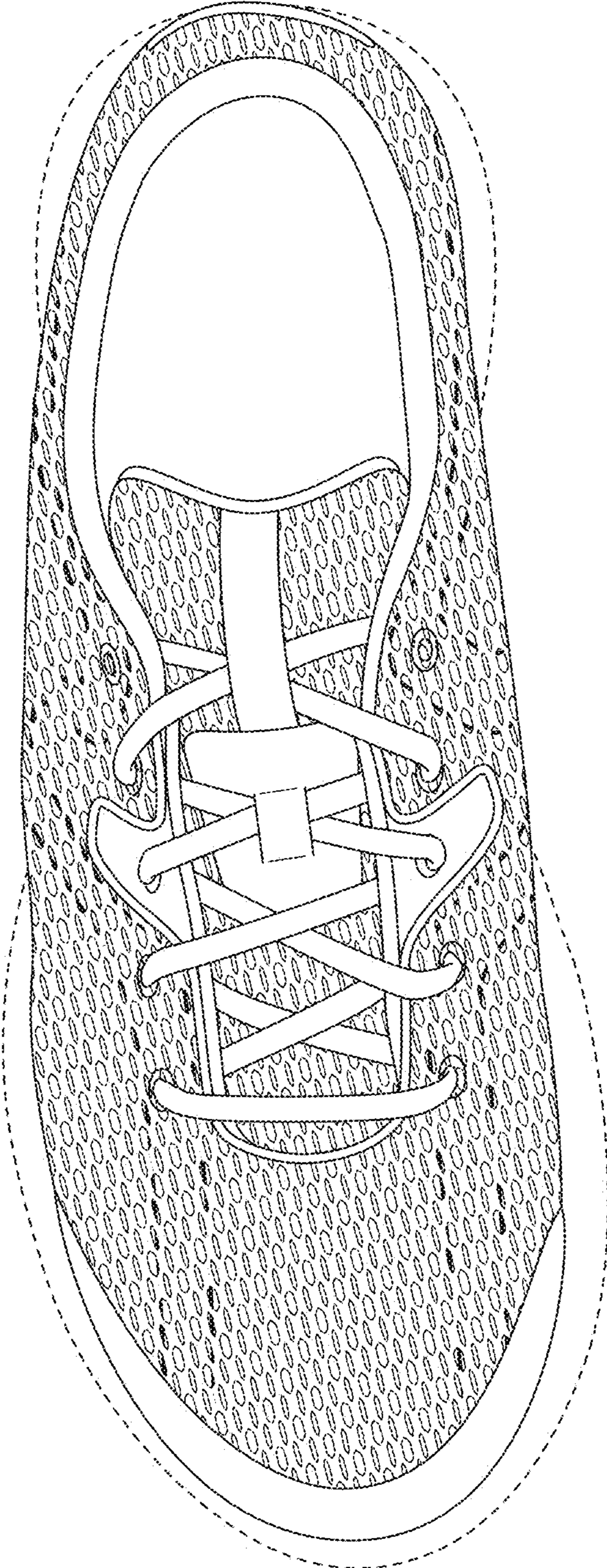

FIG. 6

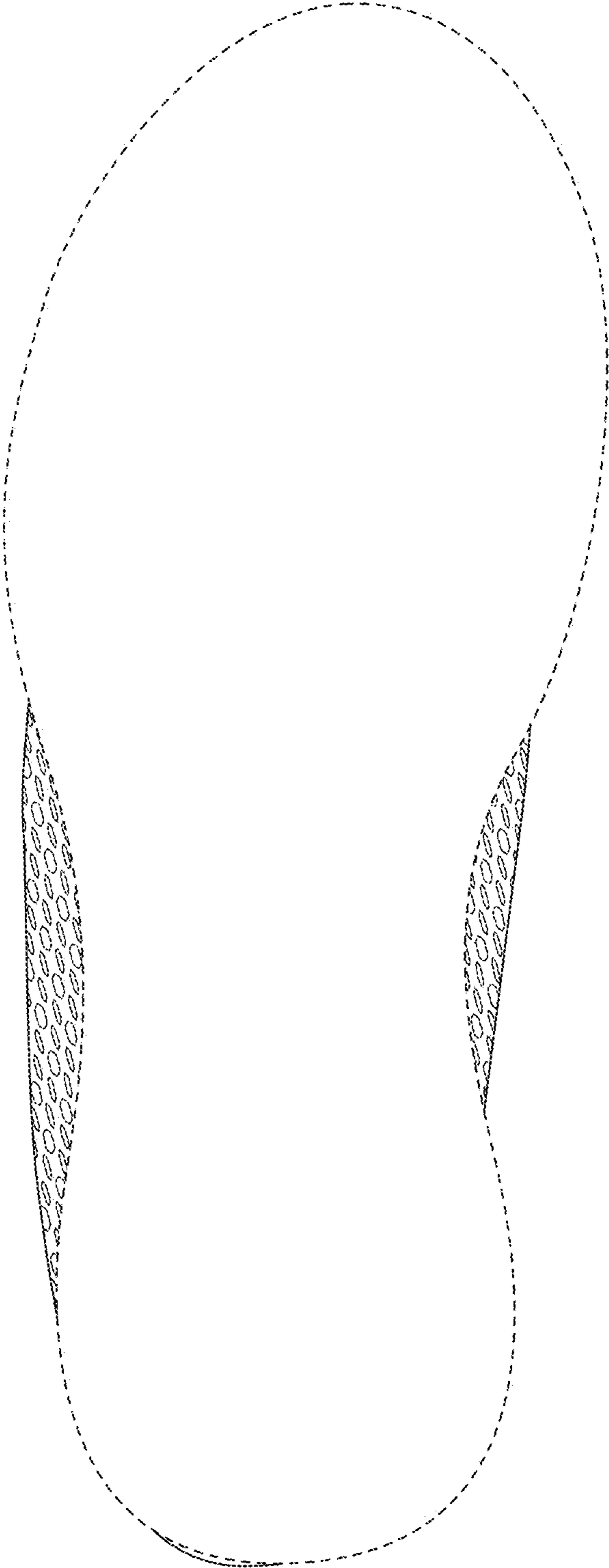

FIG. 7