



US00D707848S

(12) **United States Design Patent**
Shigeno et al.

(10) **Patent No.:** **US D707,848 S**
(45) **Date of Patent:** **** Jun. 24, 2014**

(54) **TRAY FOR VITAL SIGNS MONITOR**

(75) Inventors: **Takashi Shigeno**, Kawasaki (JP);
Kazuya Andachi, Tokyo (JP);
Yoshikazu Inami, Akashi (JP); **Ayumu Okada**, Aichi (JP); **Tomonori Inoue**,
Kyoto (JP); **Yoshihisa Miwa**, Kusatsu
(JP)

(73) Assignee: **Omron Healthcare Co., Ltd.**, Kyoto
(JP)

(**) Term: **14 Years**

(21) Appl. No.: **29/399,250**

(22) Filed: **Aug. 11, 2011**

(30) **Foreign Application Priority Data**

Feb. 15, 2011 (JP) 2011-003116

(51) **LOC (10) Cl.** **24-02**

(52) **U.S. Cl.**
USPC **D24/229**

(58) **Field of Classification Search**
USPC D24/123, 176, 216, 218, 224, 226-232;
422/99, 102, 104, 297, 300, 559;
433/77; D3/304, 307, 308, 313-315;
D7/500, 550.1, 543, 602, 554.3, 361,
D7/354, 587; 206/438; 211/74; D6/406.1,
D6/406.3, 406.4

See application file for complete search history.

(56) **References Cited**

U.S. PATENT DOCUMENTS

D202,013 S * 8/1965 Hamilton D24/229
D209,641 S * 12/1967 Golberg D24/230
D213,933 S * 4/1969 Folkman D24/230
D213,934 S * 4/1969 Folkman D24/229

D218,077 S * 7/1970 Gabriel D24/229
D237,317 S * 10/1975 Nowaskowski et al. D24/229
D248,871 S * 8/1978 Forsman et al. D24/230
D249,362 S * 9/1978 Forsman et al. D24/230
D325,526 S * 4/1992 Deguchi et al. D9/415
D343,687 S * 1/1994 Houghton et al. D24/227
D402,767 S * 12/1998 Davis et al. D24/229
D437,941 S * 2/2001 Frattini D24/229
D442,697 S * 5/2001 Hajianpour D24/229
D450,391 S * 11/2001 Hunt et al. D24/227
D471,640 S * 3/2003 McMichael et al. D24/229
D471,641 S * 3/2003 McMichael et al. D24/229
D480,816 S * 10/2003 McMichael et al. D24/229
D489,973 S * 5/2004 Root et al. D9/415
D495,807 S * 9/2004 Agbodoe et al. D24/229
D565,743 S * 4/2008 Phillips et al. D24/229
D618,821 S * 6/2010 Larsen D24/227
D631,558 S * 1/2011 Harmston et al. D24/229
D646,796 S * 10/2011 Walter D24/227
D650,912 S * 12/2011 Tomes et al. D24/227

* cited by examiner

Primary Examiner — T. Chase Nelson

Assistant Examiner — Mark Cavanna

(74) *Attorney, Agent, or Firm* — Capitol City TechLaw

(57) **CLAIM**

The ornamental design for a tray for vital signs monitor, as shown.

DESCRIPTION

FIG. 1 is a front perspective view of a tray for vital signs monitor showing our new design;
FIG. 2 is a rear perspective view thereof;
FIG. 3 is a front view thereof;
FIG. 4 is a rear view thereof;
FIG. 5 is a top view thereof;
FIG. 6 is a bottom view thereof;
FIG. 7 is a right side view thereof; and,
FIG. 8 is a left side view thereof.

1 Claim, 8 Drawing Sheets

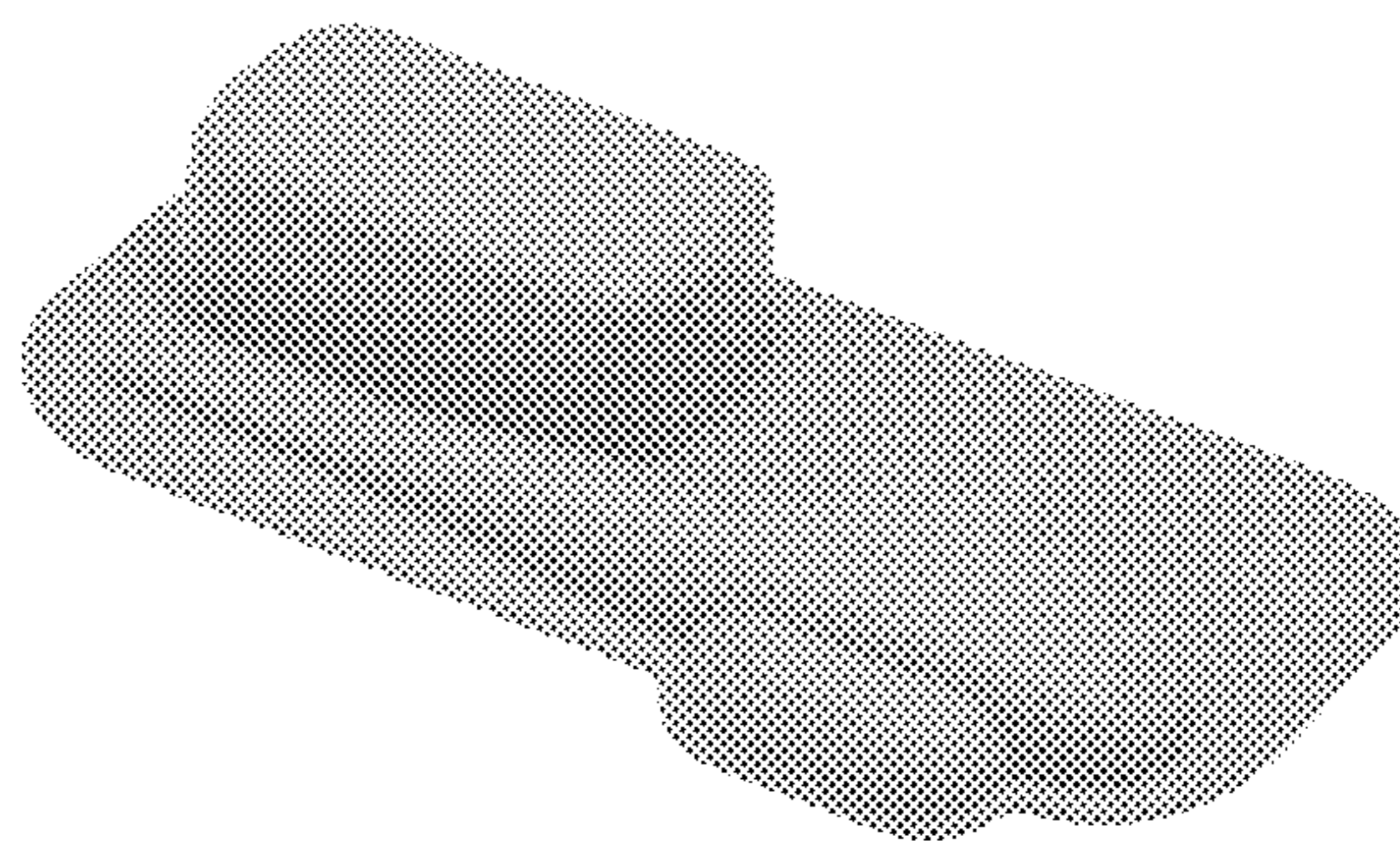
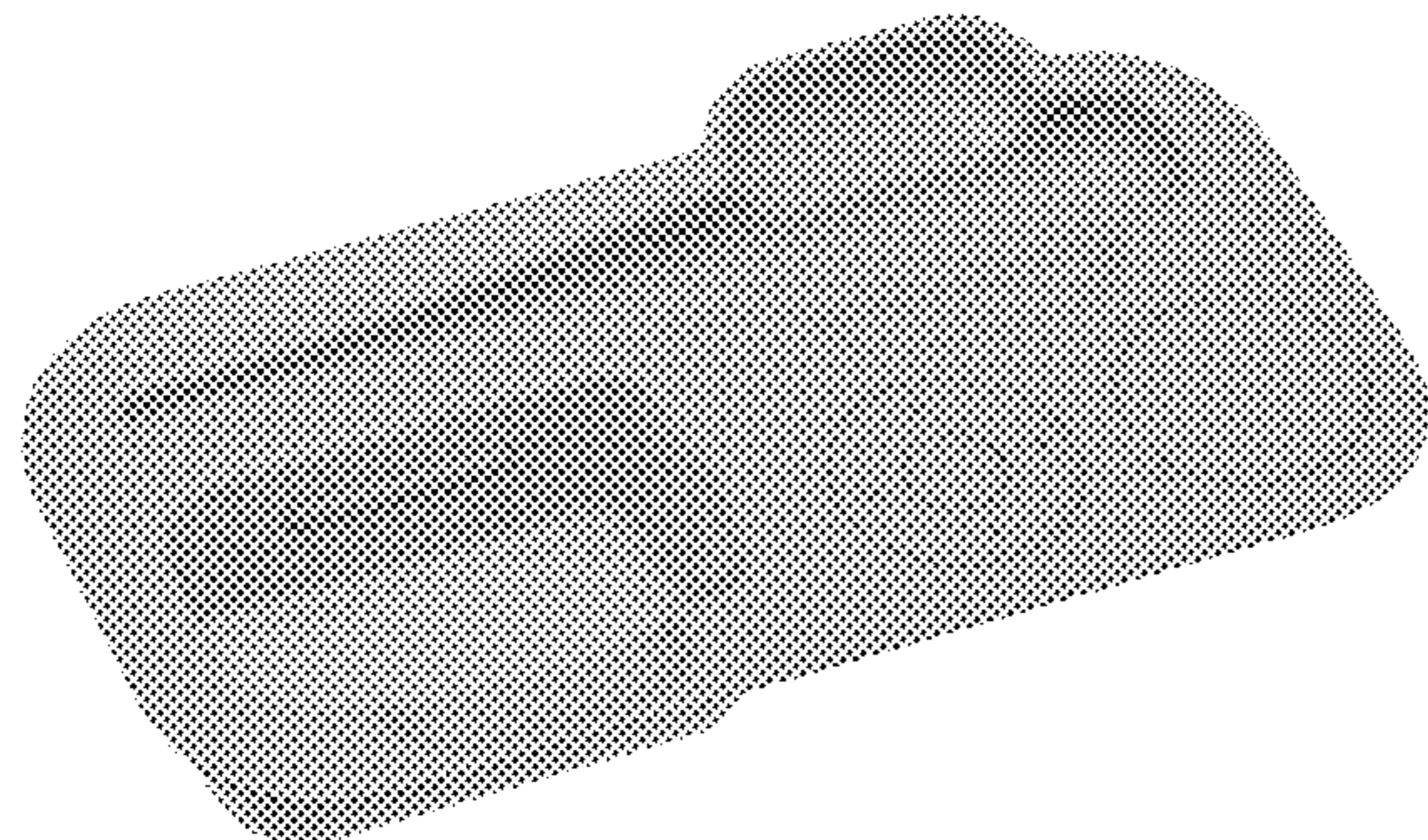

FIG.1

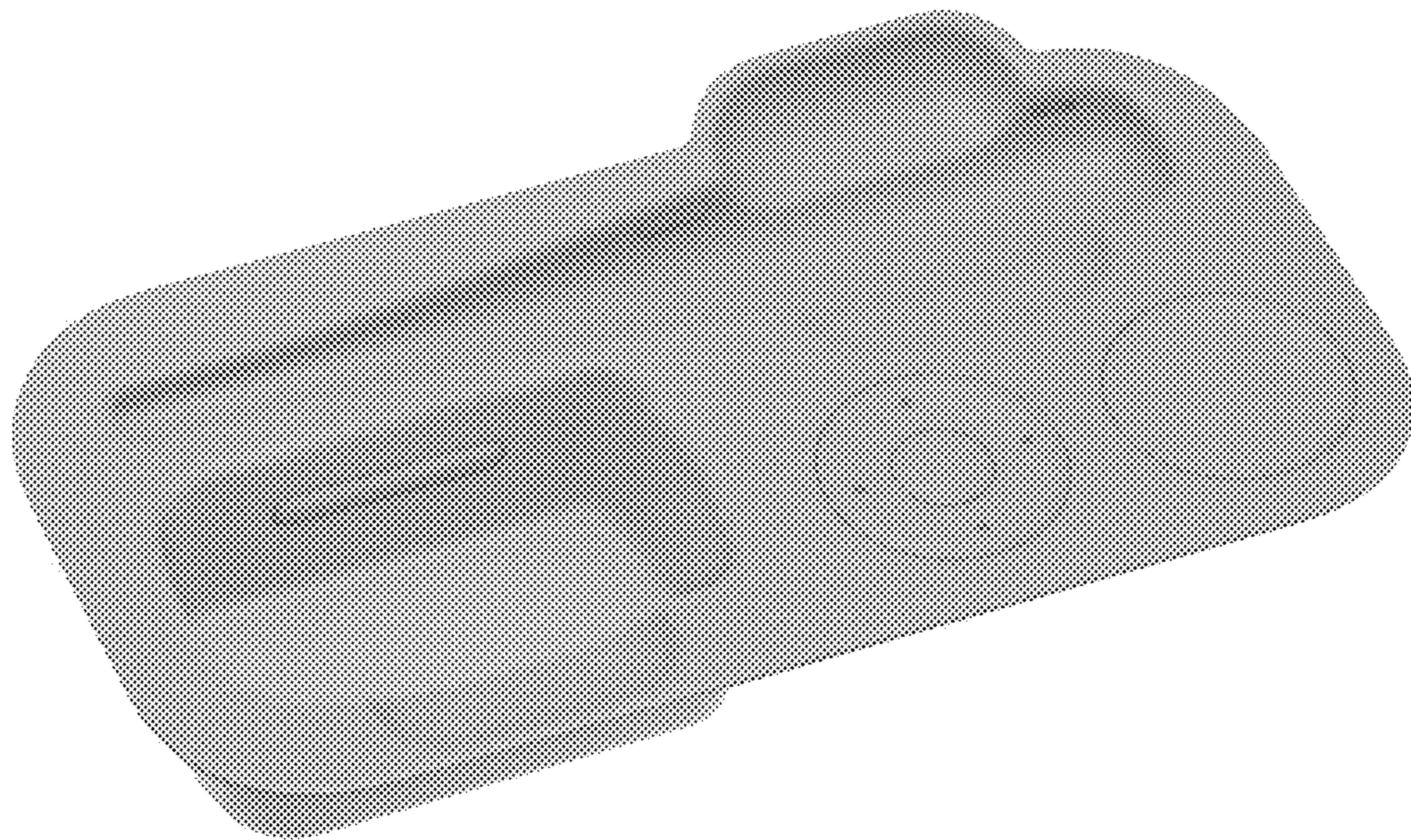

FIG.2

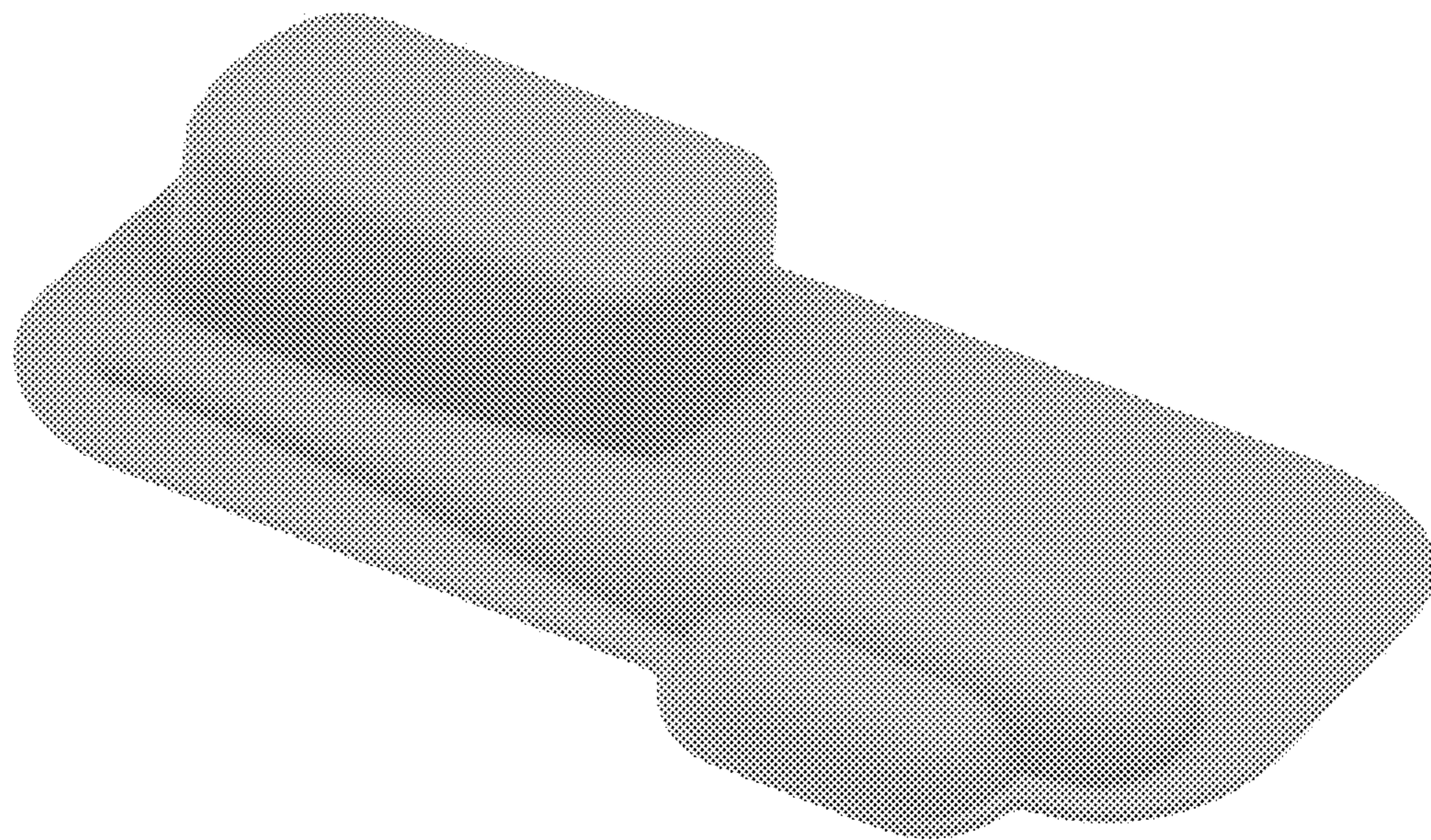

FIG.3

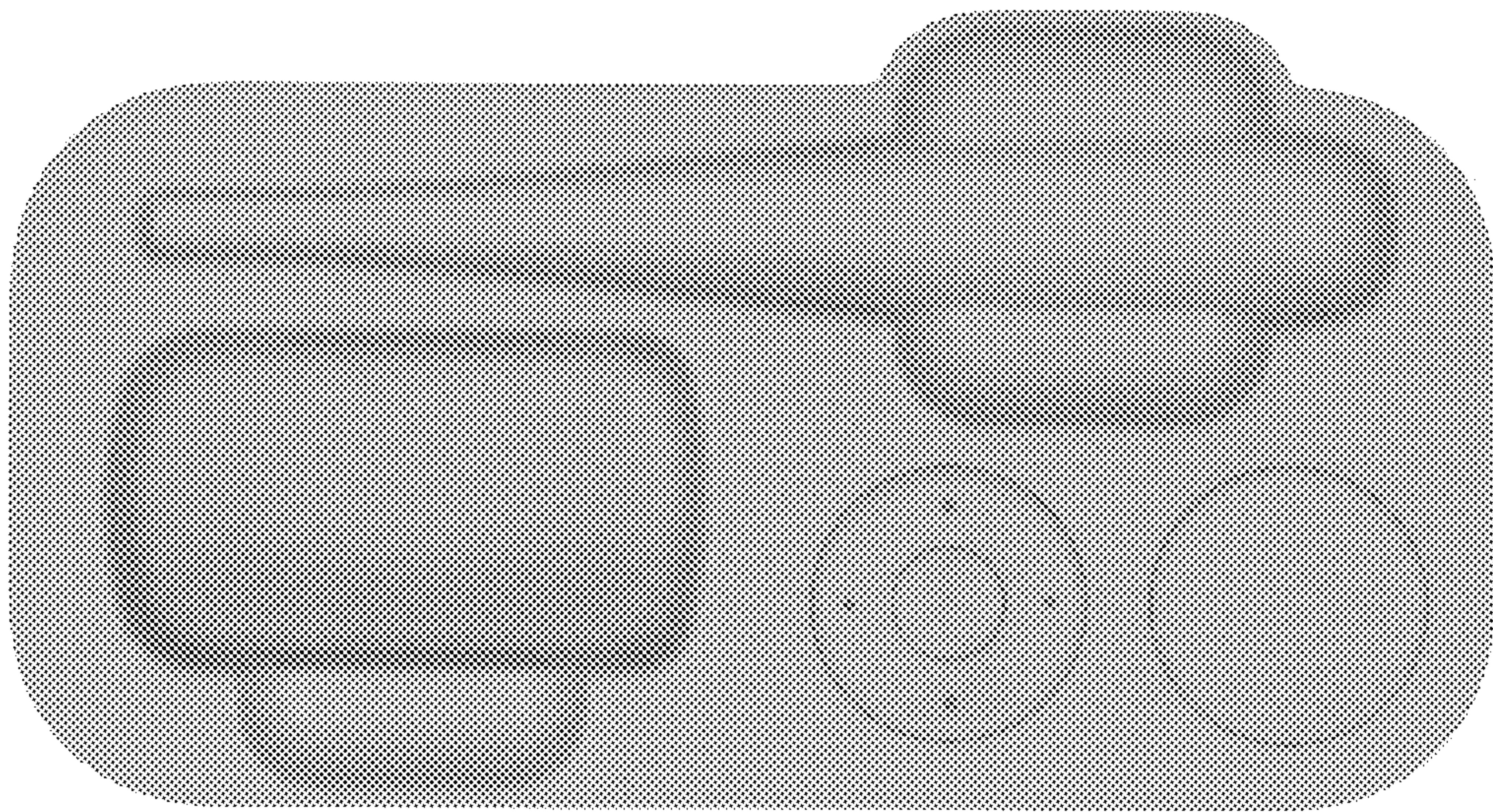

FIG.4

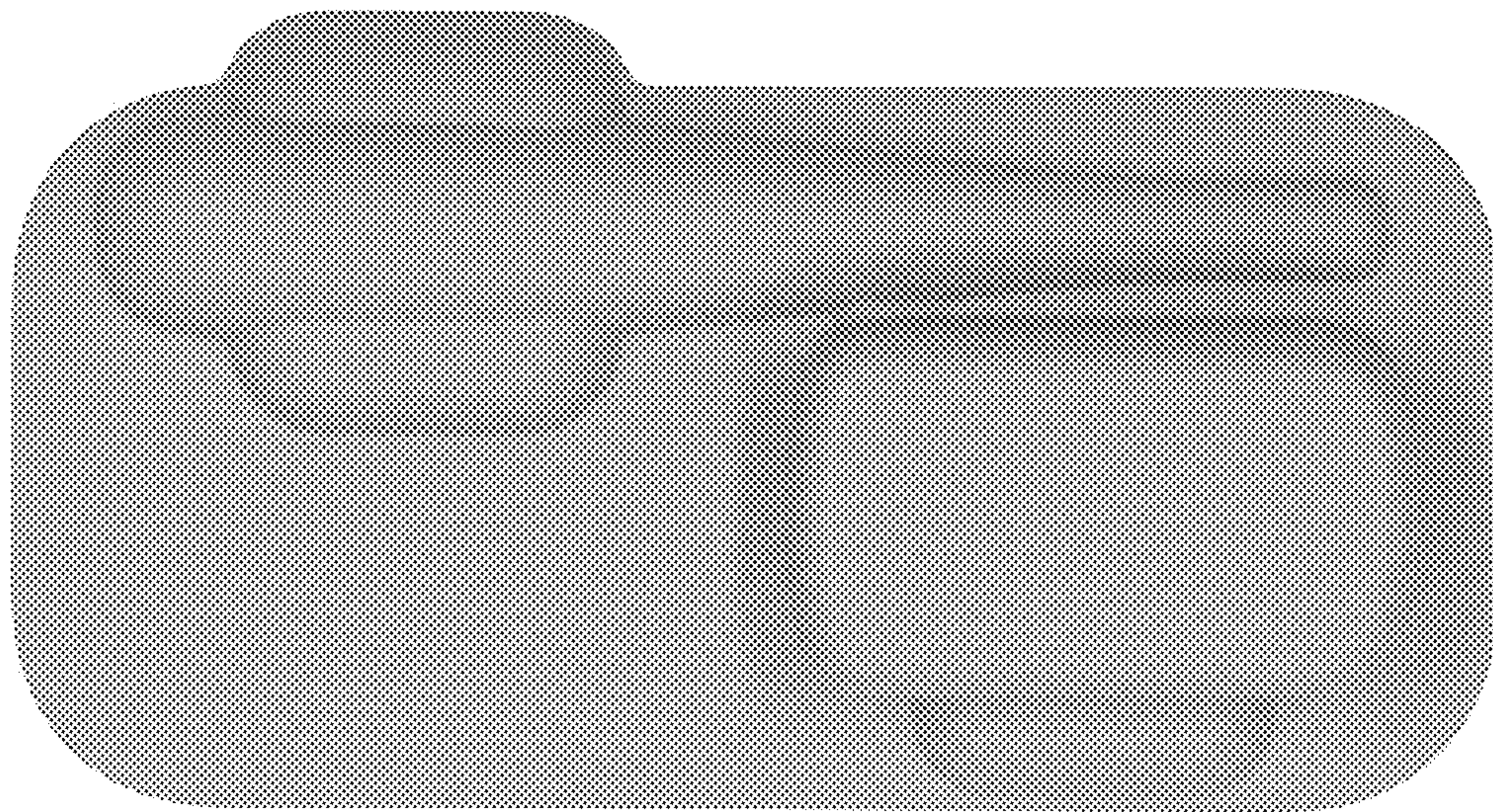

FIG.5

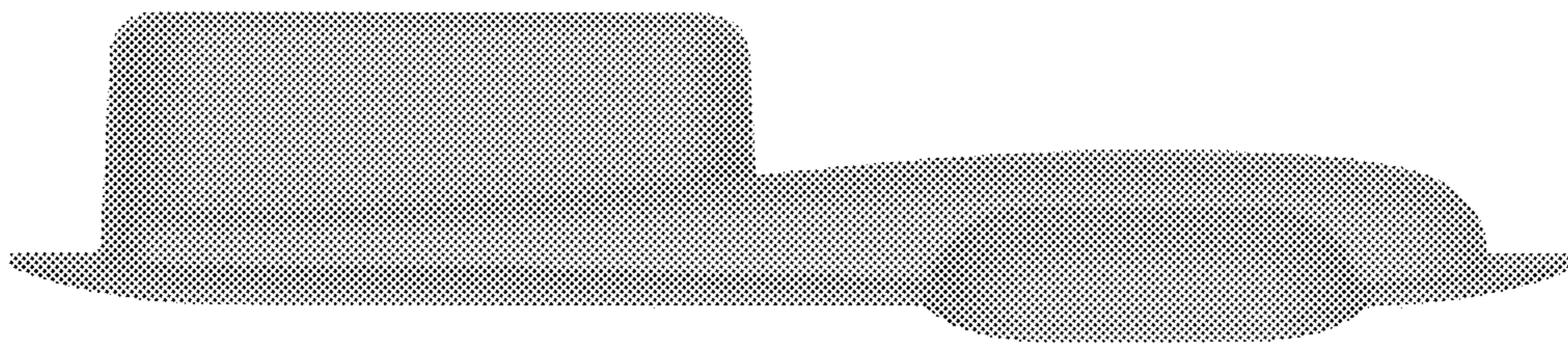

FIG.6

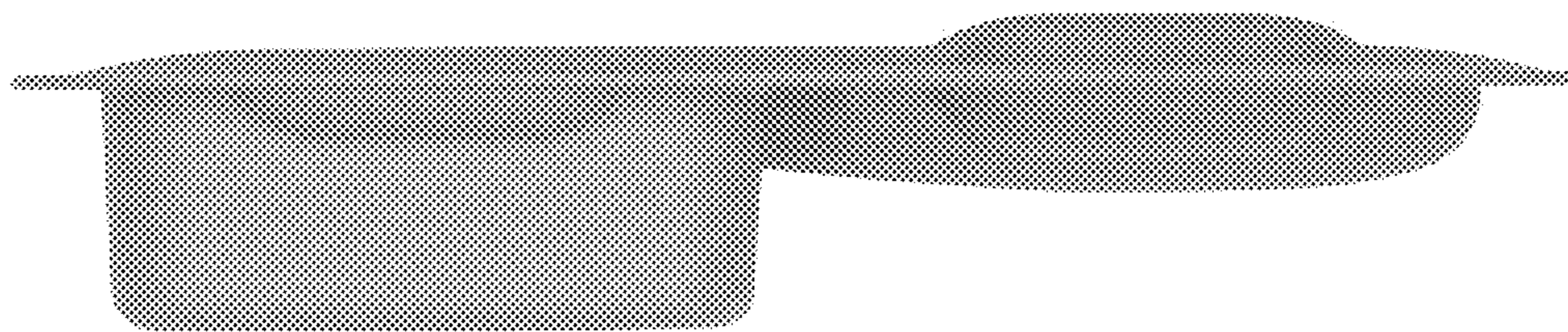

FIG.7

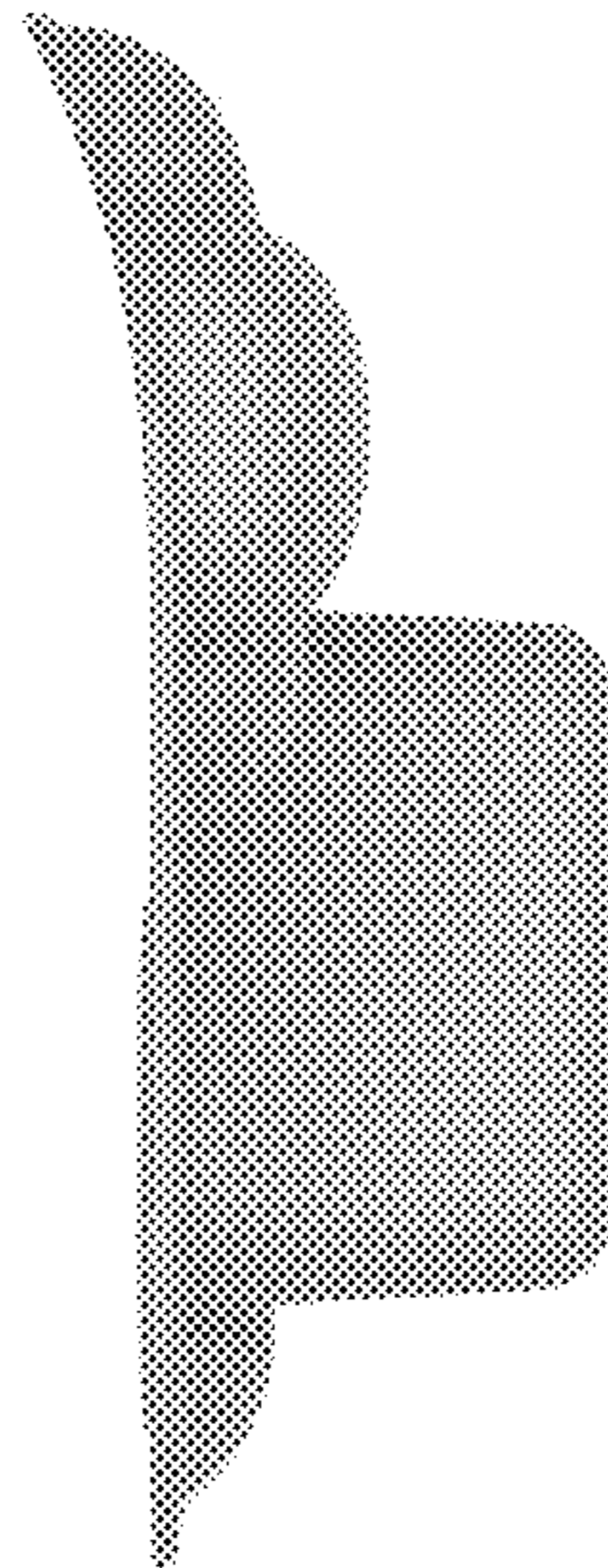

FIG.8

