

US00D707836S

(12) **United States Design Patent**
Long

(10) **Patent No.:** **US D707,836 S**
(45) **Date of Patent:** **** Jun. 24, 2014**

- (54) **PEDICURE SPA BASE**
- (71) Applicant: **Christopher L. Long**, Baltimore, MD (US)
- (72) Inventor: **Christopher L. Long**, Baltimore, MD (US)
- (**) Term: **14 Years**
- (21) Appl. No.: **29/441,191**
- (22) Filed: **Jan. 2, 2013**
- (51) **LOC (10) Cl.** **28-03**
- (52) **U.S. Cl.**
USPC **D24/204**
- (58) **Field of Classification Search**
USPC D24/200–205, 212, 213; D28/56, 61;
D6/336, 495; 601/6, 15, 64, 157–158,
601/30–32; 4/622, 574.1
See application file for complete search history.

D608,898 S *	1/2010	Ton	D24/204
D612,509 S	3/2010	Tran		
D615,326 S	5/2010	Tran		
D616,560 S	5/2010	Cong		
D616,561 S	5/2010	Ton		
D618,815 S	6/2010	Dang		
D622,858 S *	8/2010	Jan	D24/204
D623,428 S	9/2010	Galati, Jr. et al.		
D626,360 S	11/2010	Galati, Jr. et al.		
D635,786 S *	4/2011	Ton	D6/336
D640,387 S *	6/2011	Tran	D24/204
D641,485 S *	7/2011	Mai	D24/204
D644,847 S *	9/2011	Nguyen	D6/336
D664,664 S *	7/2012	Mai	D24/204
D672,583 S	12/2012	Karim		
D675,704 S	2/2013	Niu		

* cited by examiner

Primary Examiner — David Muller

(74) *Attorney, Agent, or Firm* — Lowe Hauptman & Ham, LLP

(57) **CLAIM**

The ornamental design for a pedicure spa base, as shown and described.

(56) **References Cited**

U.S. PATENT DOCUMENTS

D346,043 S	4/1994	Galati, Jr. et al.		
D424,819 S	5/2000	Galati, Jr. et al.		
D434,916 S	12/2000	Galati, Jr. et al.		
D435,371 S	12/2000	Galati, Jr. et al.		
D561,903 S	2/2008	Ton		
D564,099 S *	3/2008	Ton	D24/204
D569,135 S	5/2008	Galati, Jr. et al.		
D569,986 S *	5/2008	Ton	D24/204
D571,018 S *	6/2008	Ton et al.	D24/204
D571,961 S *	6/2008	Nguyen	D28/56
D585,142 S	1/2009	Galati, Jr. et al.		
D588,707 S *	3/2009	Mai et al.	D24/213
D589,285 S	3/2009	Tran		
D600,815 S *	9/2009	Ton	D24/204

DESCRIPTION

FIG. 1 is a perspective view of the pedicure spa base;
 FIG. 2 is a front view thereof;
 FIG. 3 is a rear view thereof;
 FIG. 4 is a right side view thereof;
 FIG. 5 is a left side view thereof;
 FIG. 6 is a top view thereof;
 FIG. 7 is a bottom view thereof; and,
 FIG. 8 is a perspective view thereof.
 The broken lines of FIG. 8 form no part of the claimed design and are used to illustrate environmental structure.

1 Claim, 7 Drawing Sheets

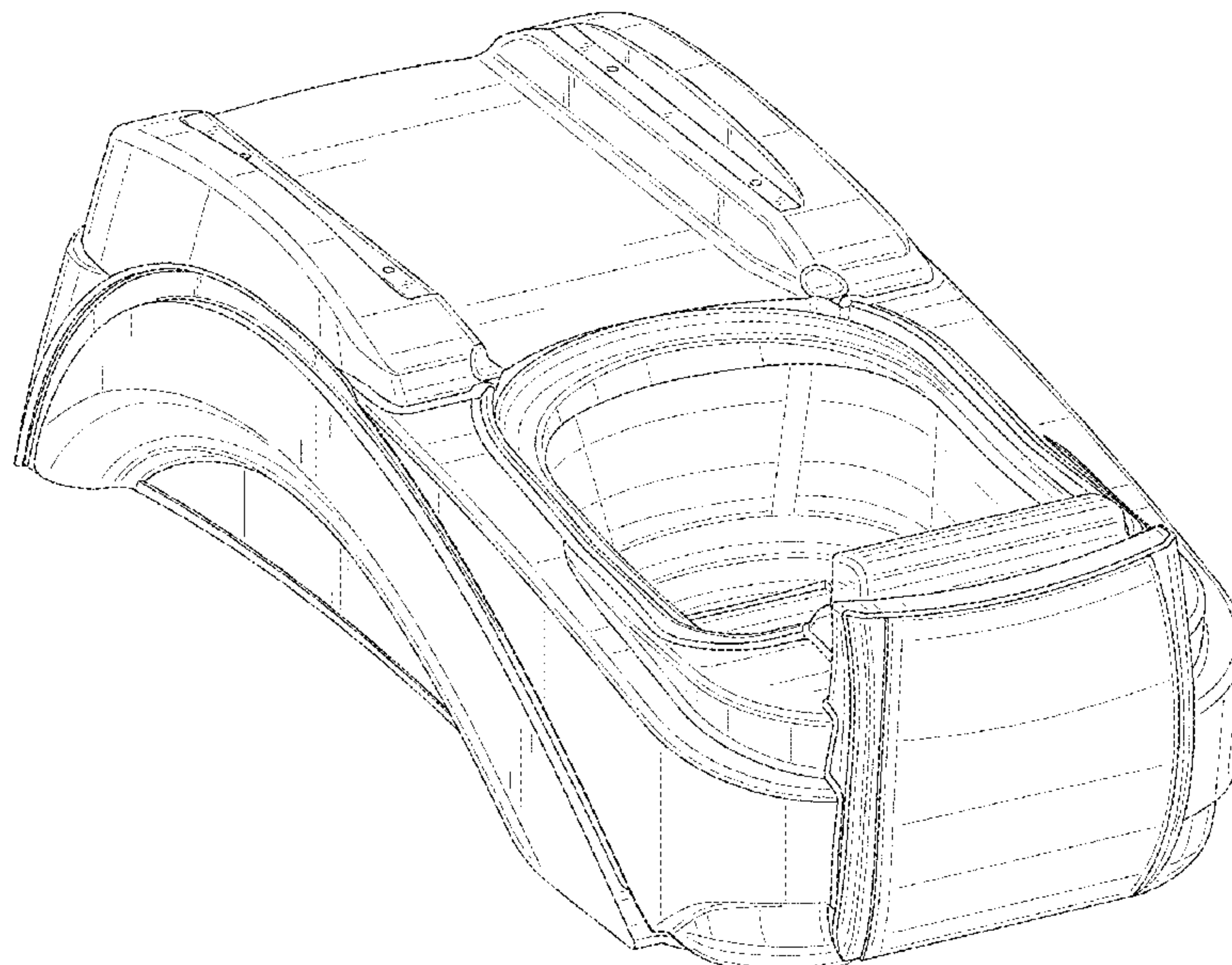

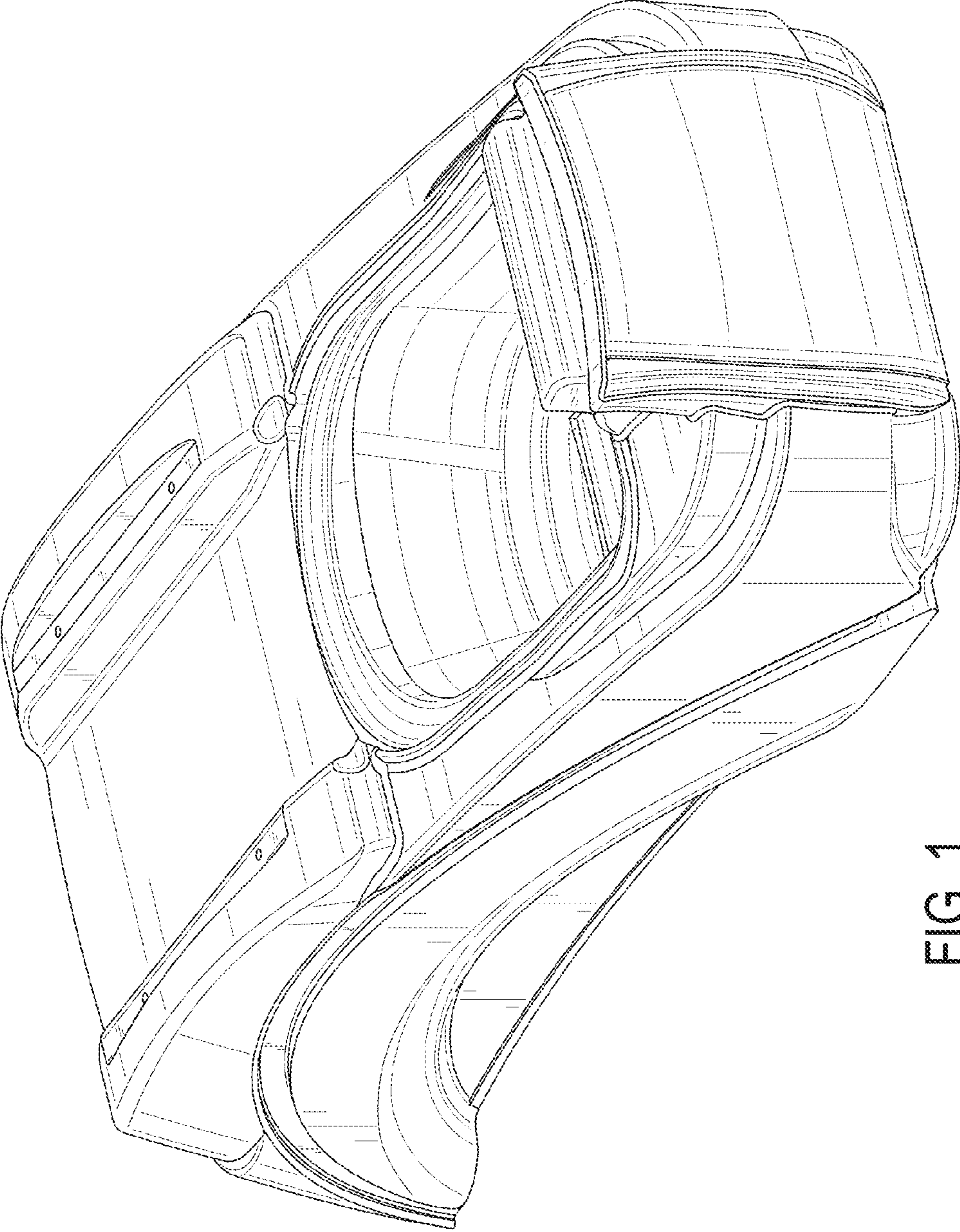

FIG. 1

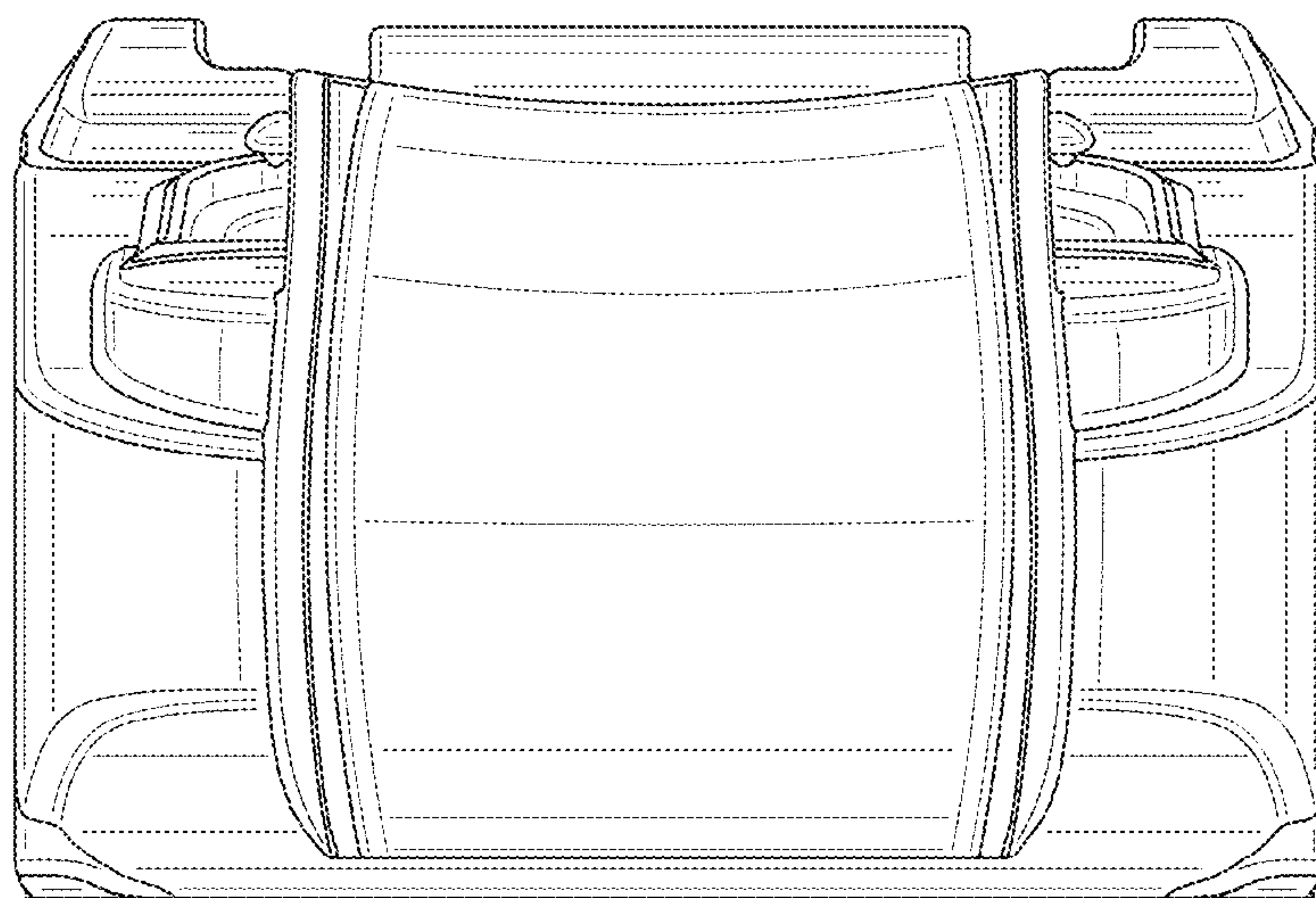

FIG. 2

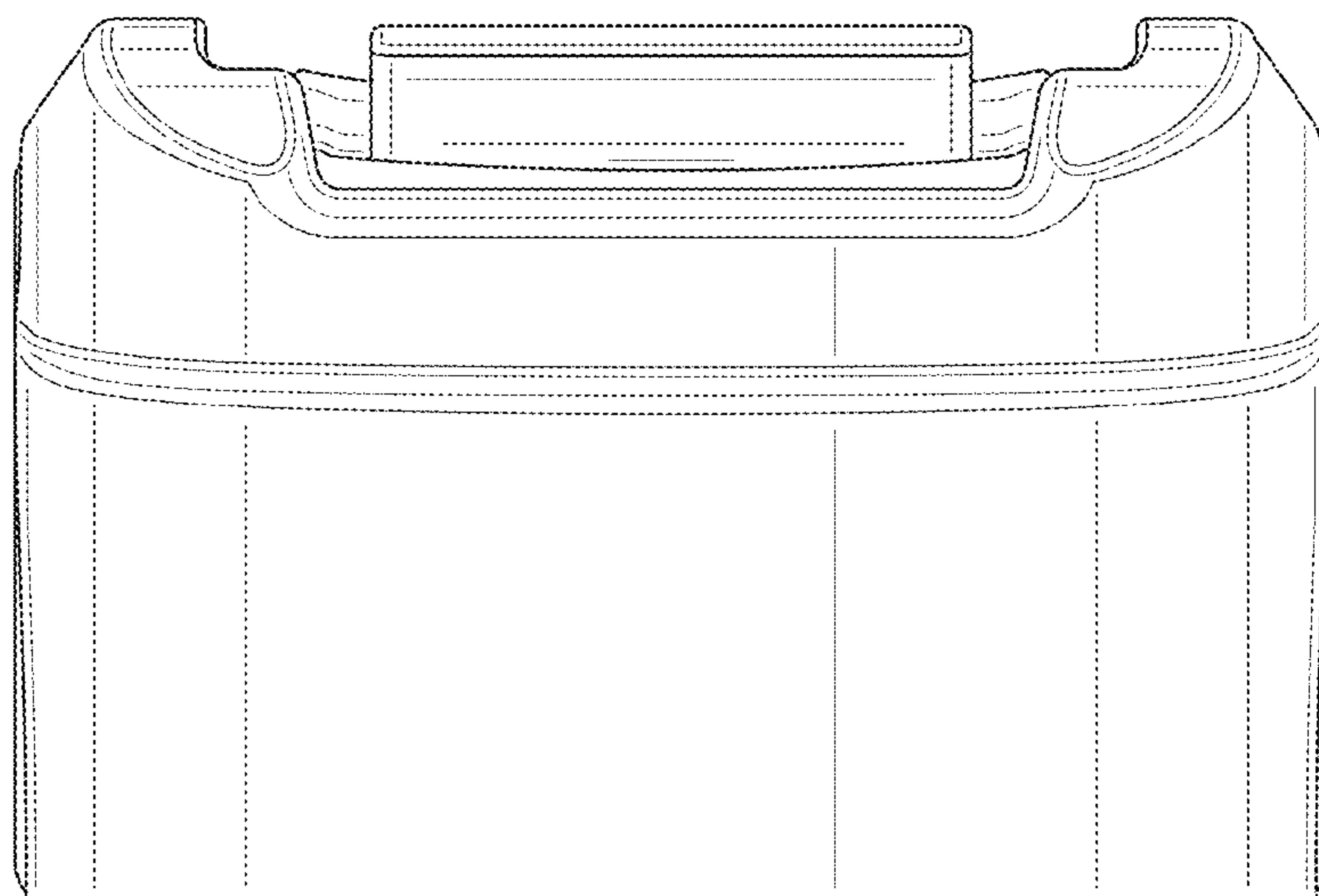

FIG. 3

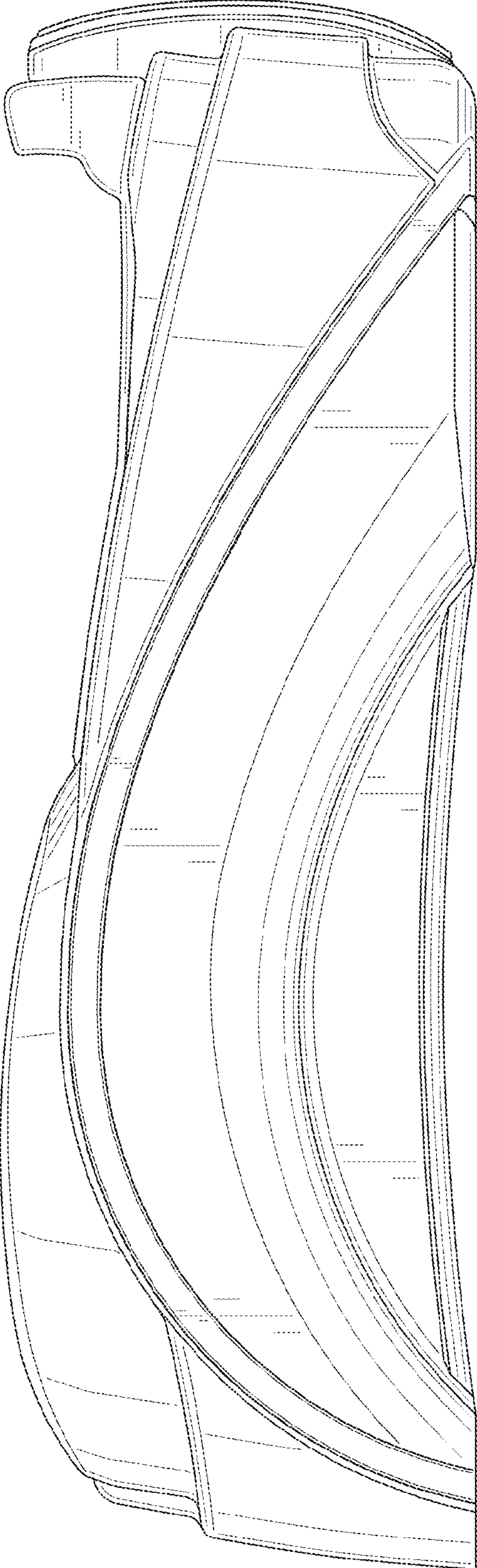

FIG. 4

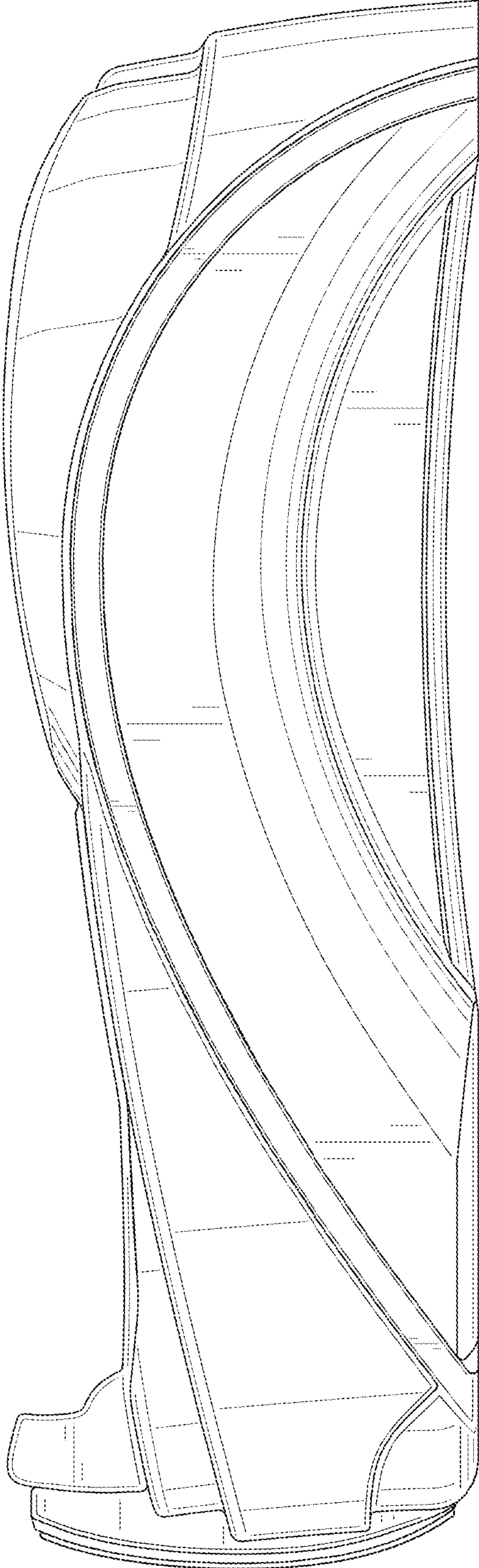

FIG. 5

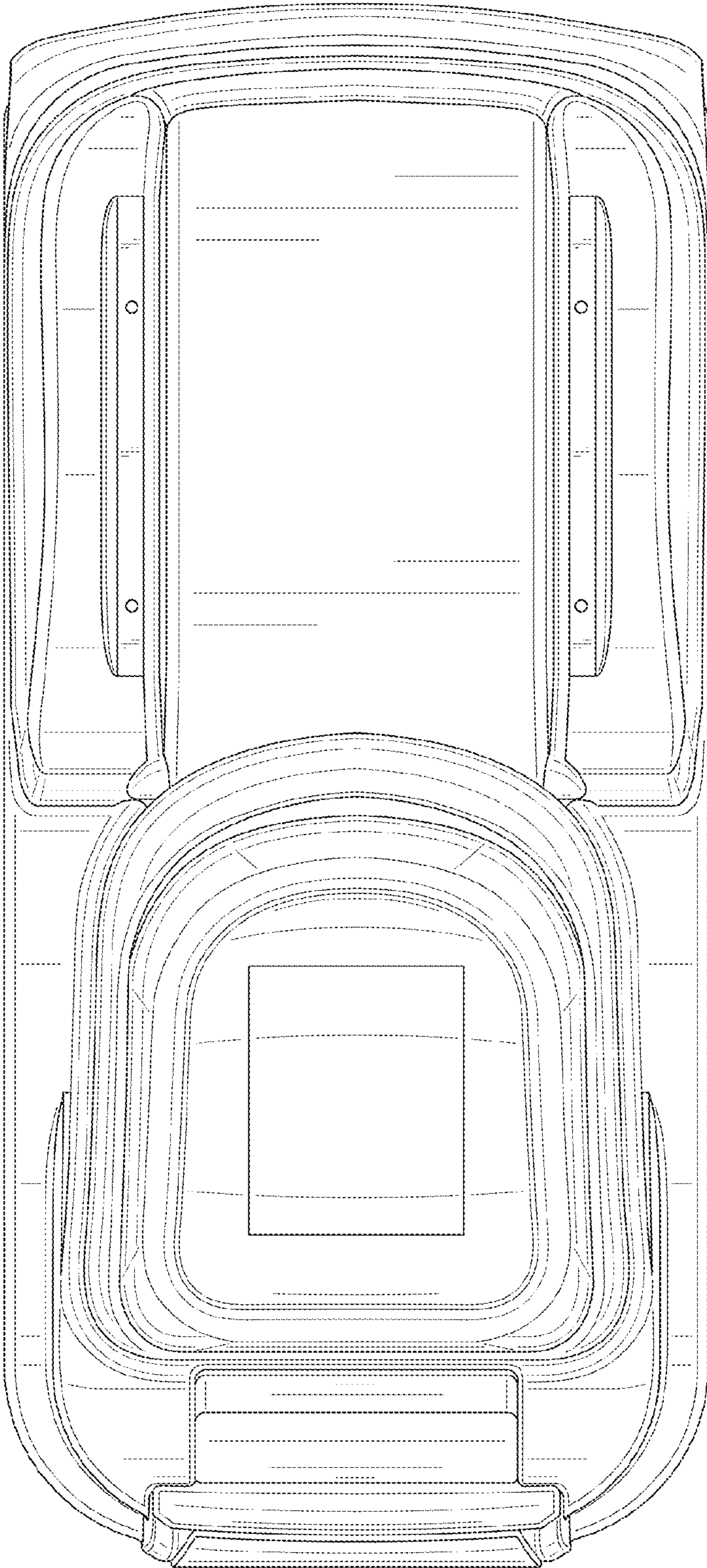

FIG. 6

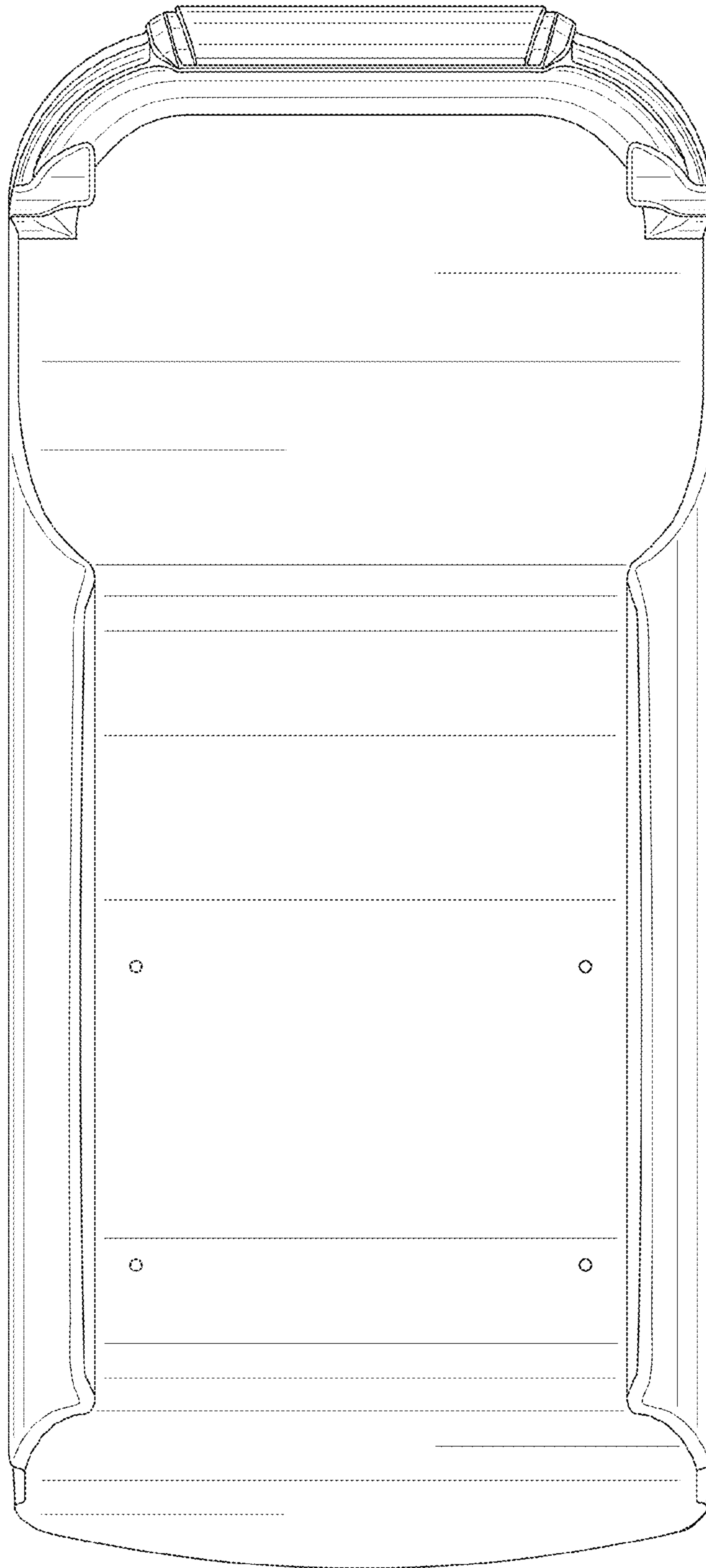

FIG. 7

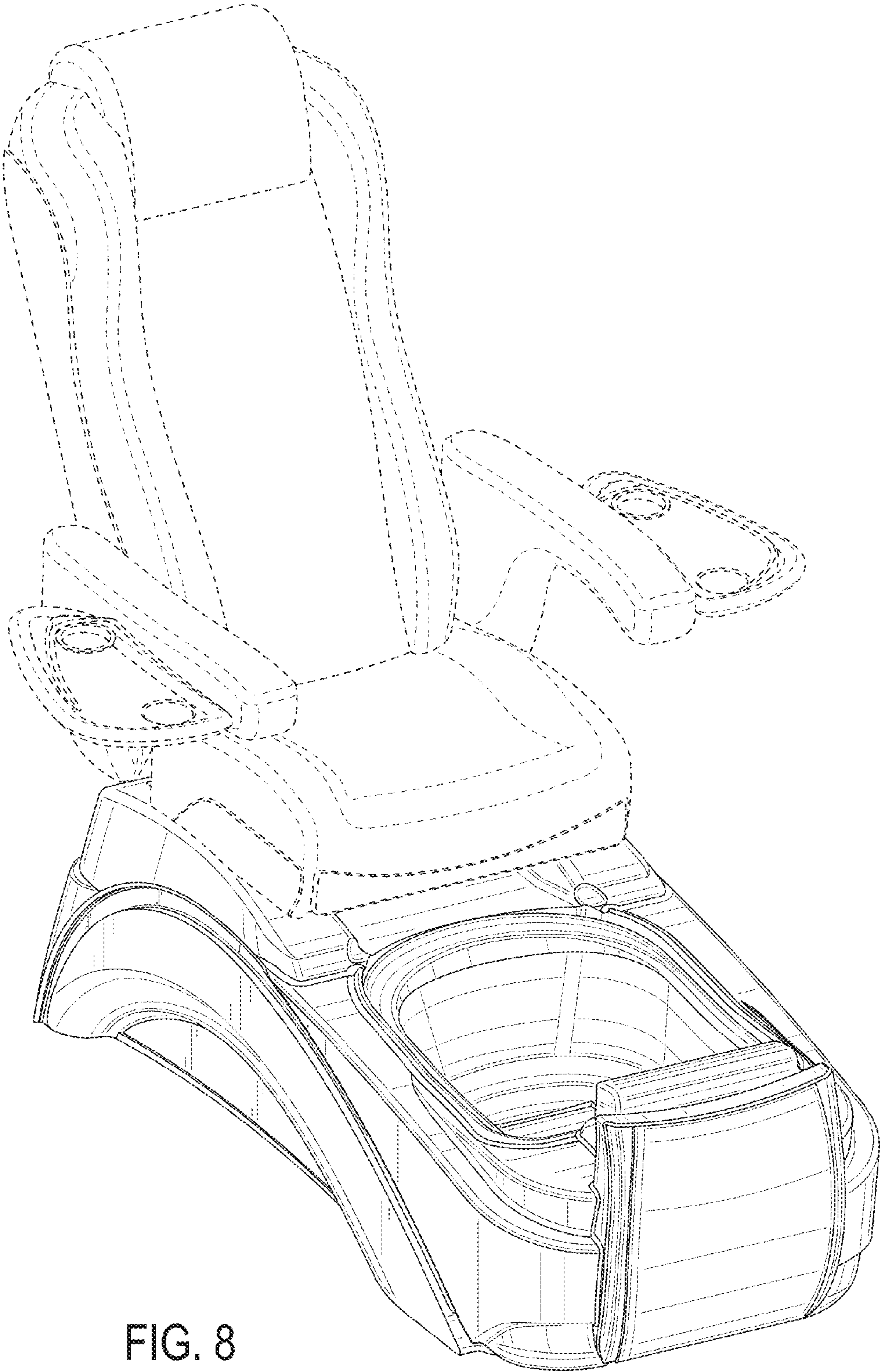

FIG. 8