



US00D707816S

(12) **United States Design Patent**
LaMontagne et al.

(10) **Patent No.:** **US D707,816 S**
(45) **Date of Patent:** **** Jun. 24, 2014**

(54) **SURGICAL FORCEPS**

(71) Applicant: **Kogent Surgical, LLC**, Chesterfield, MO (US)

(72) Inventors: **Jessica L LaMontagne**, Valley Park, MO (US); **John M Schallert**, Lake St. Louis, MO (US)

(73) Assignee: **Kogent Surgical, LLC**, Chesterfield, MO (US)

(**) Term: **14 Years**

(21) Appl. No.: **29/433,747**

(22) Filed: **Oct. 4, 2012**

(51) **LOC (10) Cl.** **24-02**

(52) **U.S. Cl.**
USPC **D24/143**; D24/144

(58) **Field of Classification Search**
USPC D24/143–144, 133, 147, 170; D28/55;
606/32, 42, 51–52, 205, 208, 210–211
See application file for complete search history.

(56) **References Cited**

U.S. PATENT DOCUMENTS

4,461,297	A *	7/1984	Sutter	606/210
5,116,333	A *	5/1992	Beane	606/51
6,228,084	B1 *	5/2001	Kirwan, Jr.	606/52
6,298,550	B1 *	10/2001	Kirwan, Jr.	29/825
6,592,583	B2 *	7/2003	Hirano et al.	606/52
6,860,882	B2 *	3/2005	Battles et al.	606/51

D559,984	S *	1/2008	Scheller et al.	D24/143
7,513,897	B2 *	4/2009	Sutter et al.	606/51
7,867,230	B2 *	1/2011	Asahara et al.	606/51
8,361,070	B2 *	1/2013	Hanlon et al.	606/51
2009/0012519	A1 *	1/2009	Manrique et al.	606/51
2009/0024123	A1 *	1/2009	Young	606/41
2012/0004685	A1 *	1/2012	Kienzle et al.	606/205
2013/0066317	A1 *	3/2013	Evans et al.	606/48
2014/0058425	A1 *	2/2014	Porat	606/205

* cited by examiner

Primary Examiner — Wan Laymon

(74) *Attorney, Agent, or Firm* — Kevin P. Rollins

(57) **CLAIM**

We claim the ornamental design for a surgical forceps, as substantially shown and described.

DESCRIPTION

FIG. 1 is a perspective view of a surgical forceps showing our new design;
 FIG. 2 is a top view of a surgical forceps;
 FIG. 3 is a top view of a tip portion of a surgical forceps, shown at an enlarged scale;
 FIG. 4 is a bottom view of a surgical forceps;
 FIG. 5 is a bottom view of a tip portion of a surgical forceps;
 FIG. 6 is a side view of a surgical forceps;
 FIG. 7 is side view of a tip portion of a surgical forceps;
 FIG. 8 is a front view of a surgical forceps, shown at an enlarged scale; and,
 FIG. 9 is a back view of a surgical forceps, shown at an enlarged scale.

1 Claim, 6 Drawing Sheets

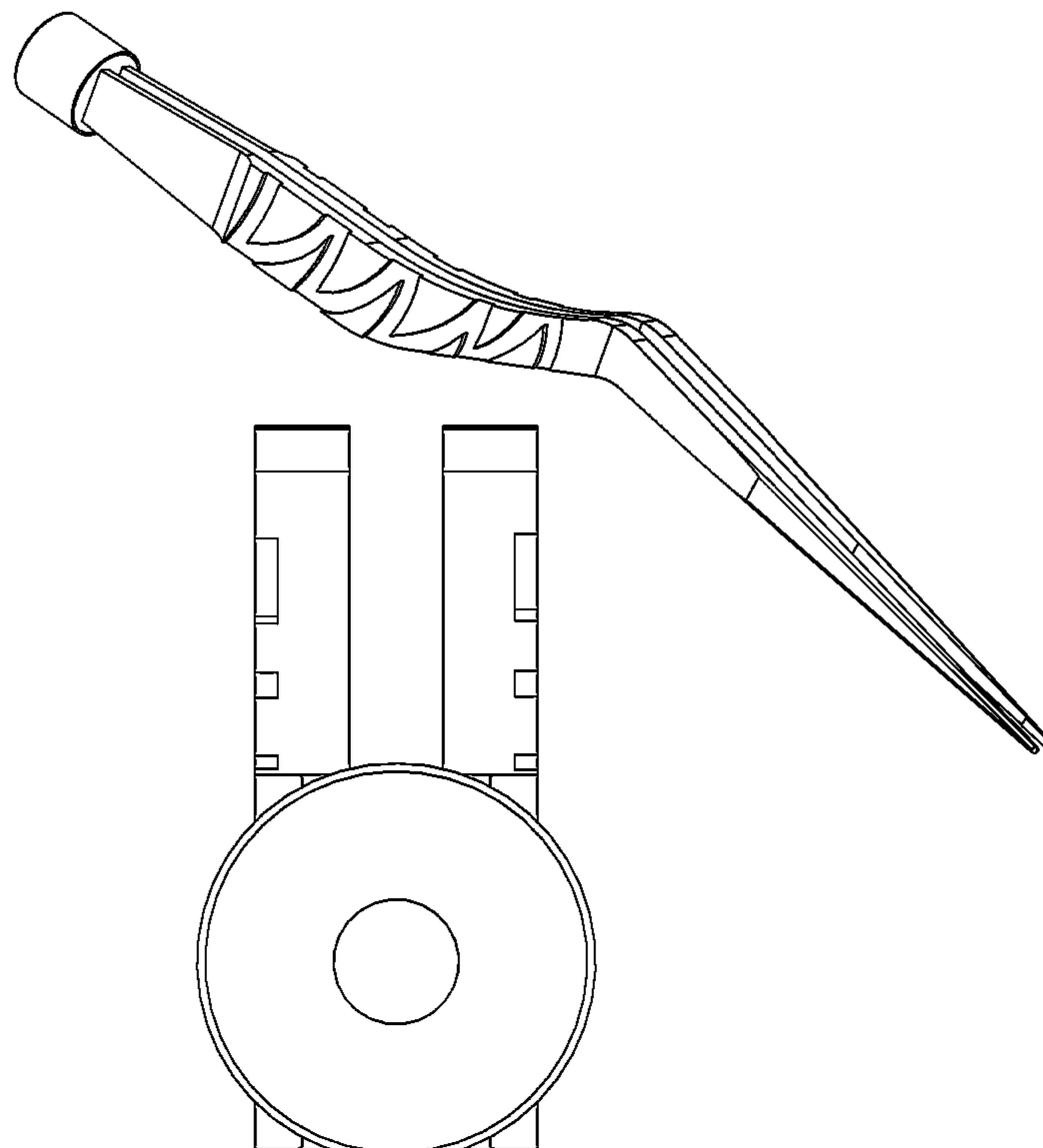

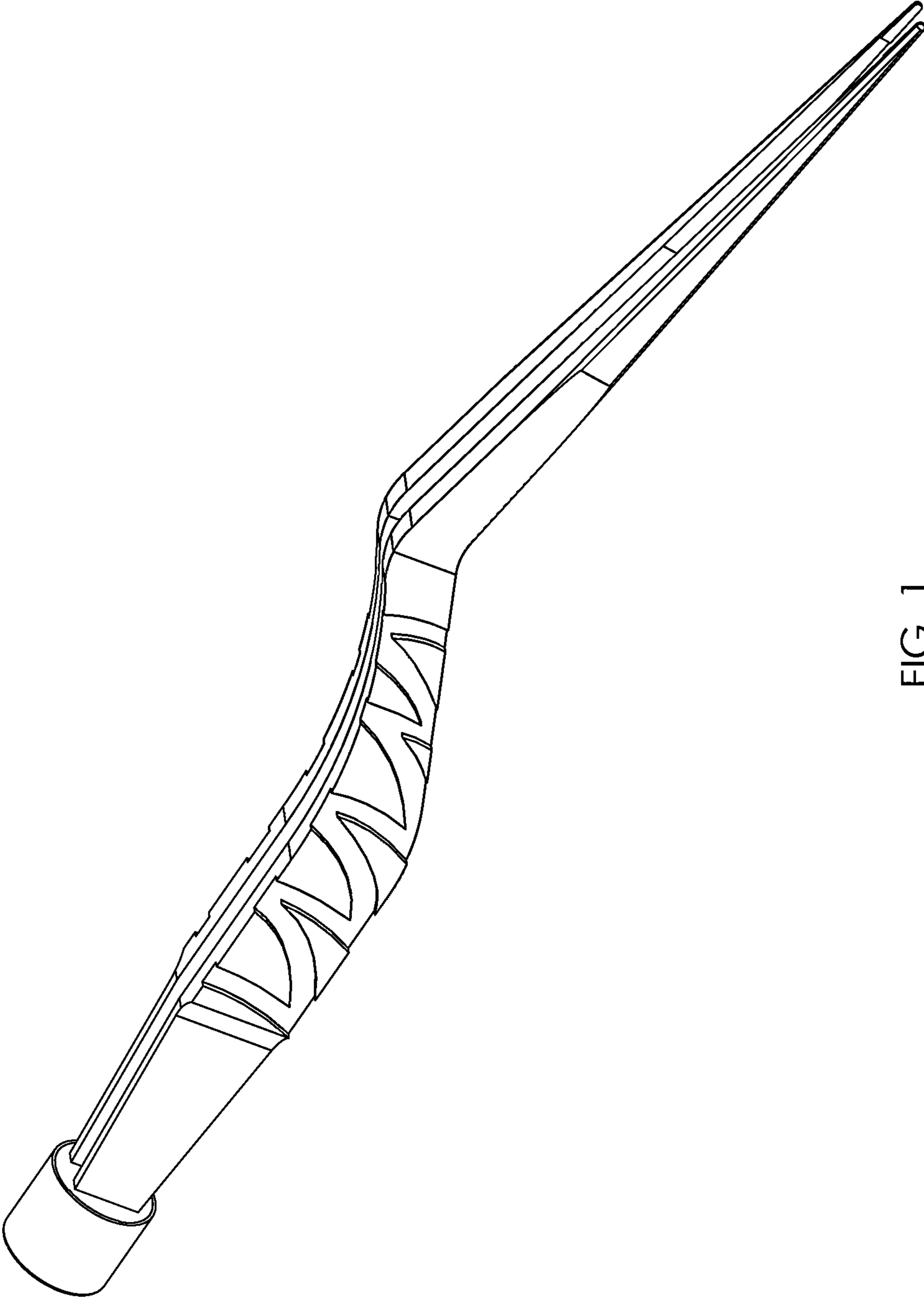

FIG. 1

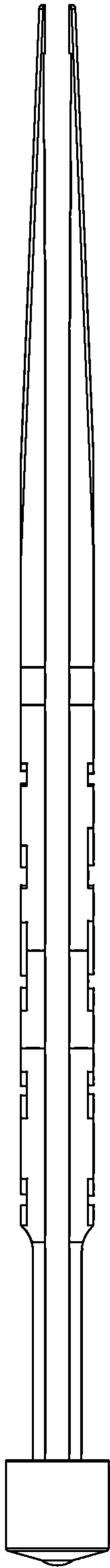

FIG. 2

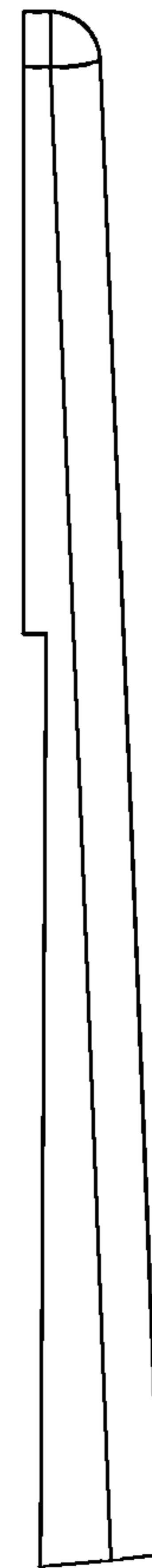
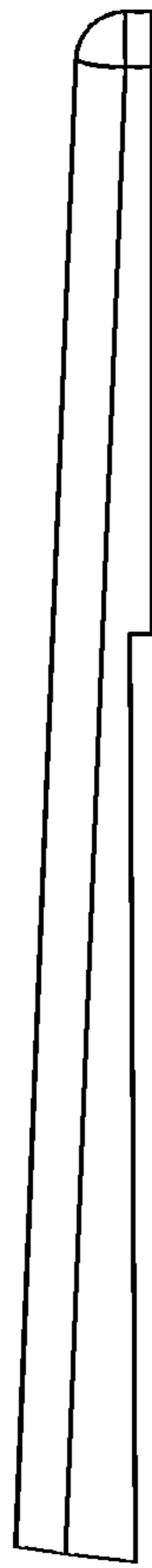

FIG. 3

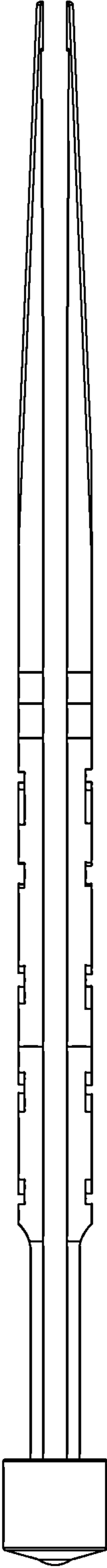

FIG. 4

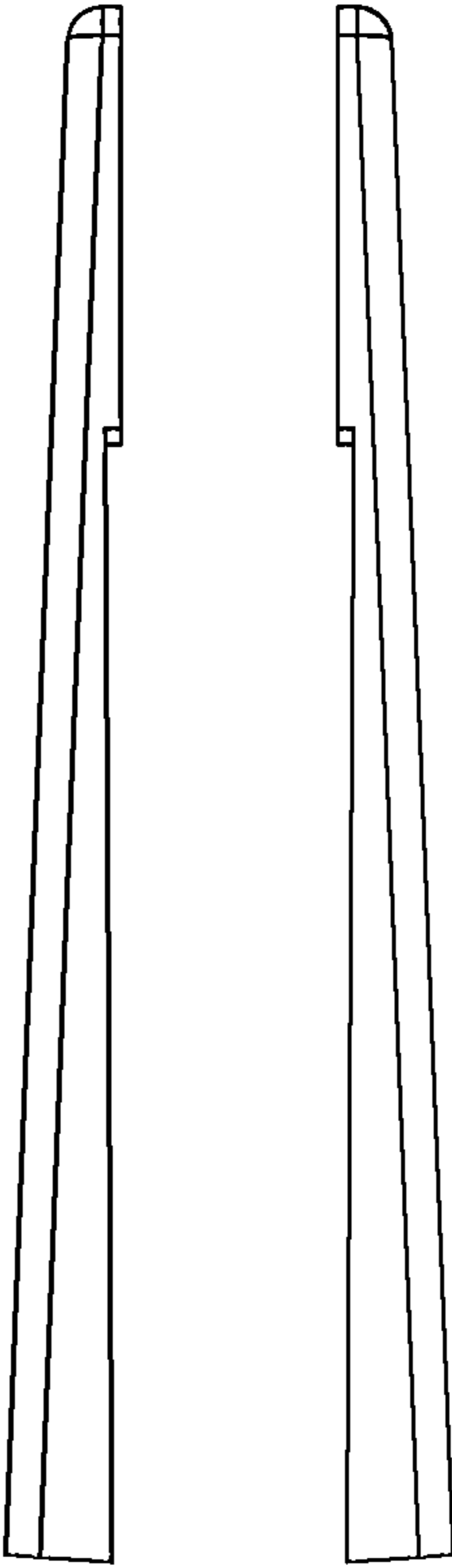

FIG. 5

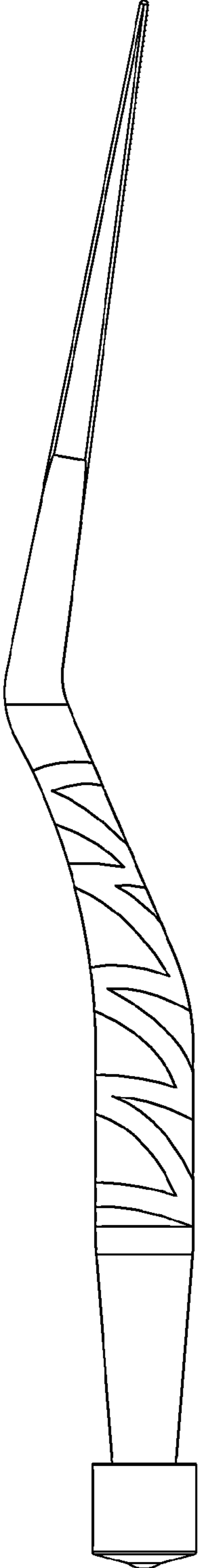

FIG. 6

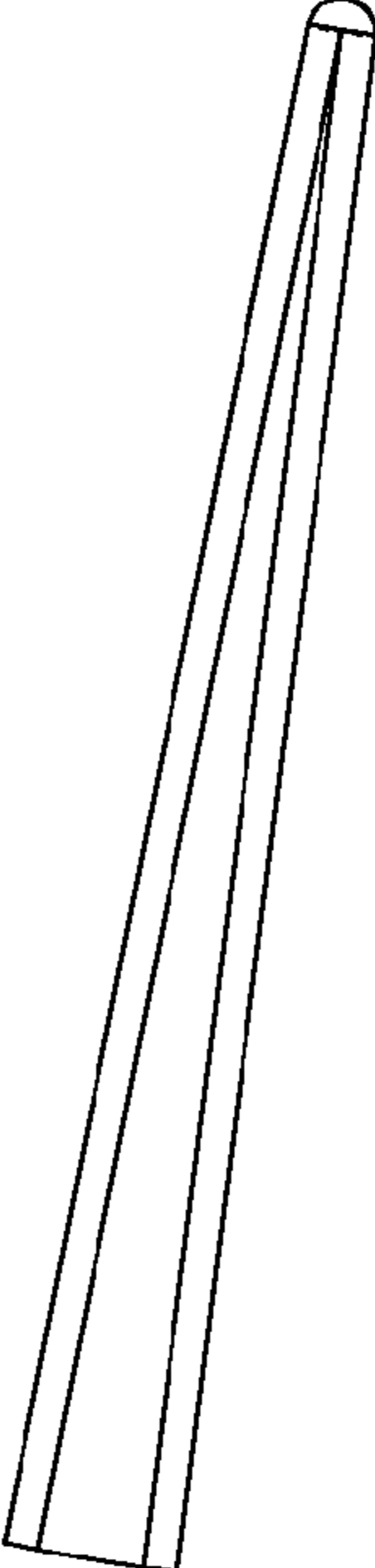

FIG. 7

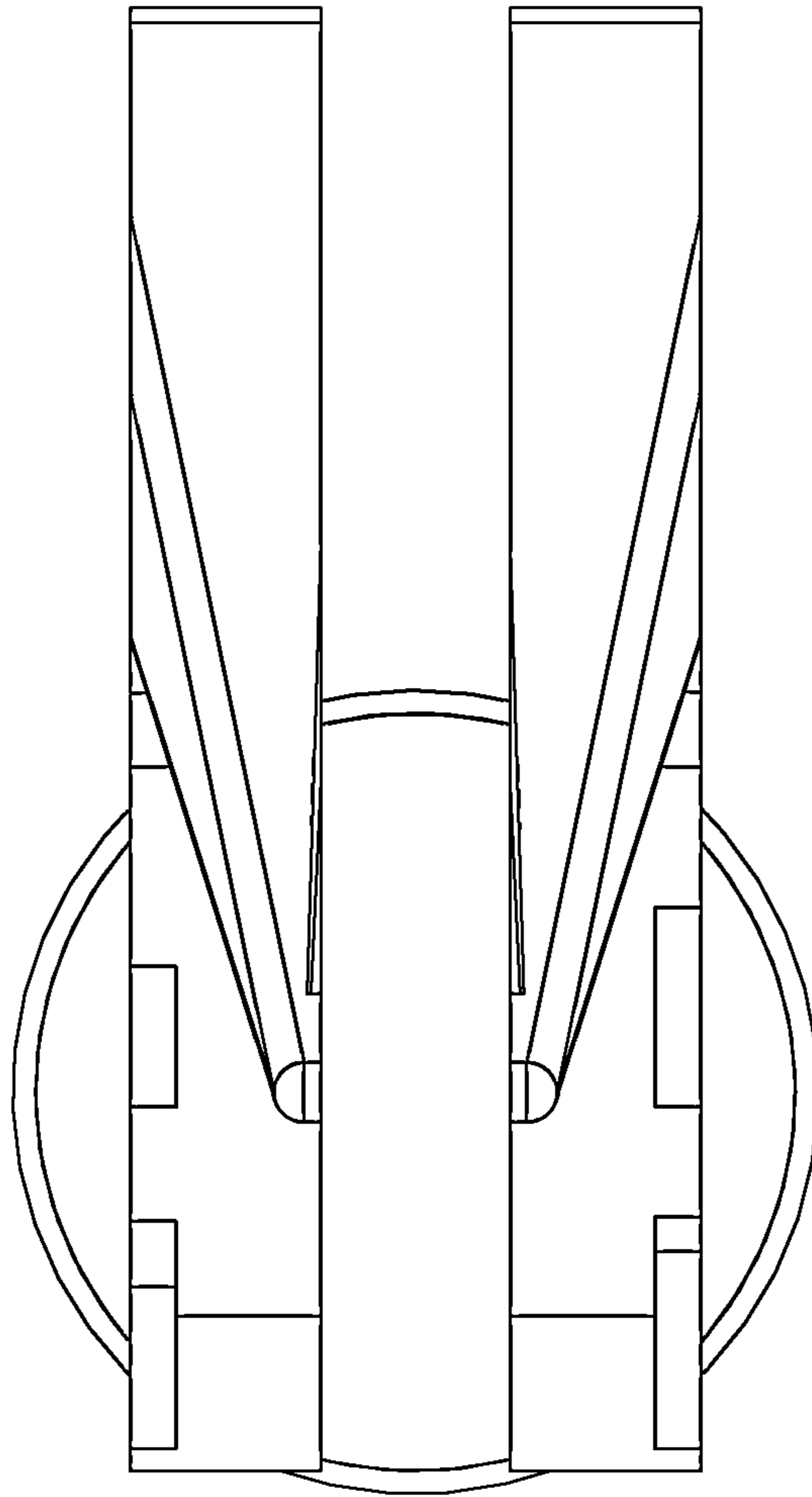

FIG. 8

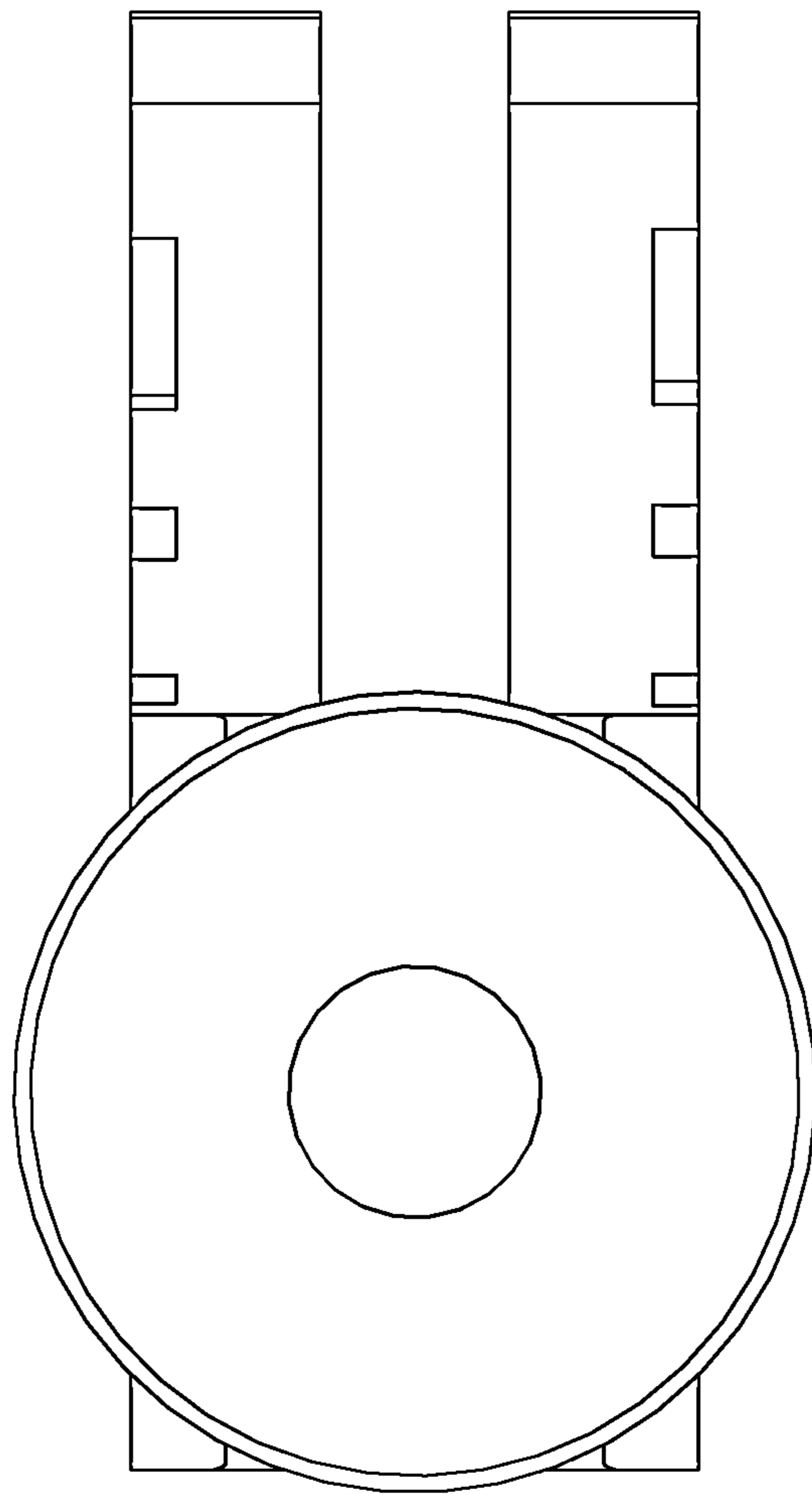

FIG. 9