



US00D707806S

(12) **United States Design Patent**
Brewer et al.

(10) **Patent No.:** **US D707,806 S**
(45) **Date of Patent:** **** Jun. 24, 2014**

- (54) **AIR FRESHENER HOUSING**
- (71) Applicant: **The Procter & Gamble Company**,
Cincinnati, OH (US)
- (72) Inventors: **Matthew Joshua Brewer**, Deerfield
Township, OH (US); **John William
Koenig**, Cincinnati, OH (US); **Igor
Ivanovich Zemskov**, Dublin, OH (US);
Stephen Adam Hughett, Westerville,
OH (US); **Rainer Bernhard Teufel**,
Worthington, OH (US)
- (73) Assignee: **The Procter & Gamble Company**,
Cincinnati, OH (US)

D583,451 S	*	12/2008	Aloe et al.	D23/366
D583,452 S	*	12/2008	Aloe et al.	D23/366
D593,669 S	*	6/2009	Daelemans et al.	D23/366
D602,141 S	*	10/2009	Harris	D23/366
D604,823 S	*	11/2009	Schwartz et al.	D23/366
D675,304 S	*	1/2013	Valentino et al.	D23/366
D681,183 S	*	4/2013	Blachford et al.	D23/366
D696,761 S	*	12/2013	Jorgensen	D23/366

* cited by examiner

Primary Examiner — Sandra Snapp
(74) *Attorney, Agent, or Firm* — Amy I Ahn-Roll

(**) Term: **14 Years**

- (21) Appl. No.: **29/475,758**
- (22) Filed: **Dec. 6, 2013**
- (51) **LOC (10) Cl.** **28-99**
- (52) **U.S. Cl.**
USPC **D23/366**
- (58) **Field of Classification Search**
USPC D23/355–369; D28/5, 6; 261/DIG. 17,
261/DIG. 42, DIG. 65, DIG. 88, DIG. 89;
392/386, 390, 394, 395; 239/34, 44,
239/53, 55, 56, 326; D26/14, 17, 98, 9, 22,
D26/24; D11/131.1; D7/509, 522, 524, 537
See application file for complete search history.

(57) **CLAIM**
The ornamental design for an air freshener housing, as shown
and described.

DESCRIPTION

FIG. 1 is a perspective view of a first embodiment of an air freshener housing;
 FIG. 2 is a back view of the first embodiment;
 FIG. 3 is a front view of the first embodiment;
 FIG. 4 is a right side view of the first embodiment;
 FIG. 5 is a left side view of the first embodiment;
 FIG. 6 is a top view of the first embodiment;
 FIG. 7 is a bottom view of the first embodiment;
 FIG. 8 is a perspective view of a second embodiment of an air freshener housing;
 FIG. 9 is a back view of the second embodiment;
 FIG. 10 is a front view of the second embodiment;
 FIG. 11 is a right side view of the second embodiment;
 FIG. 12 is a left side view of the second embodiment;
 FIG. 13 is a top view of the second embodiment; and,
 FIG. 14 is a bottom view of the second embodiment.
 The broken lines shown in the drawings are for illustrative purposes only and form no part of the claimed design.

- (56) **References Cited**
U.S. PATENT DOCUMENTS
D462,431 S * 9/2002 Bunce et al. D23/366
D512,771 S * 12/2005 Conway et al. D23/368
D574,072 S * 7/2008 Carlson et al. D23/364

1 Claim, 8 Drawing Sheets

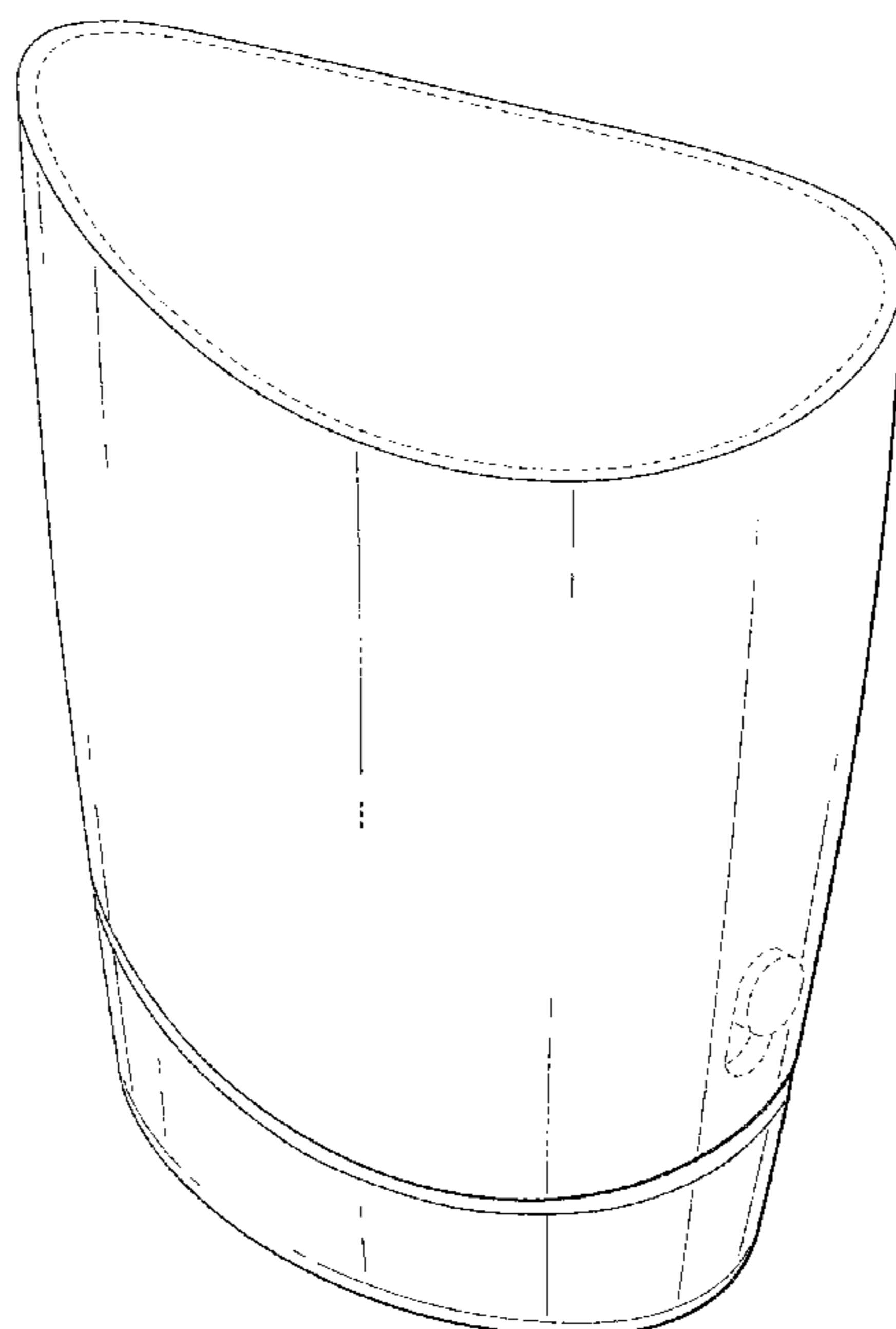

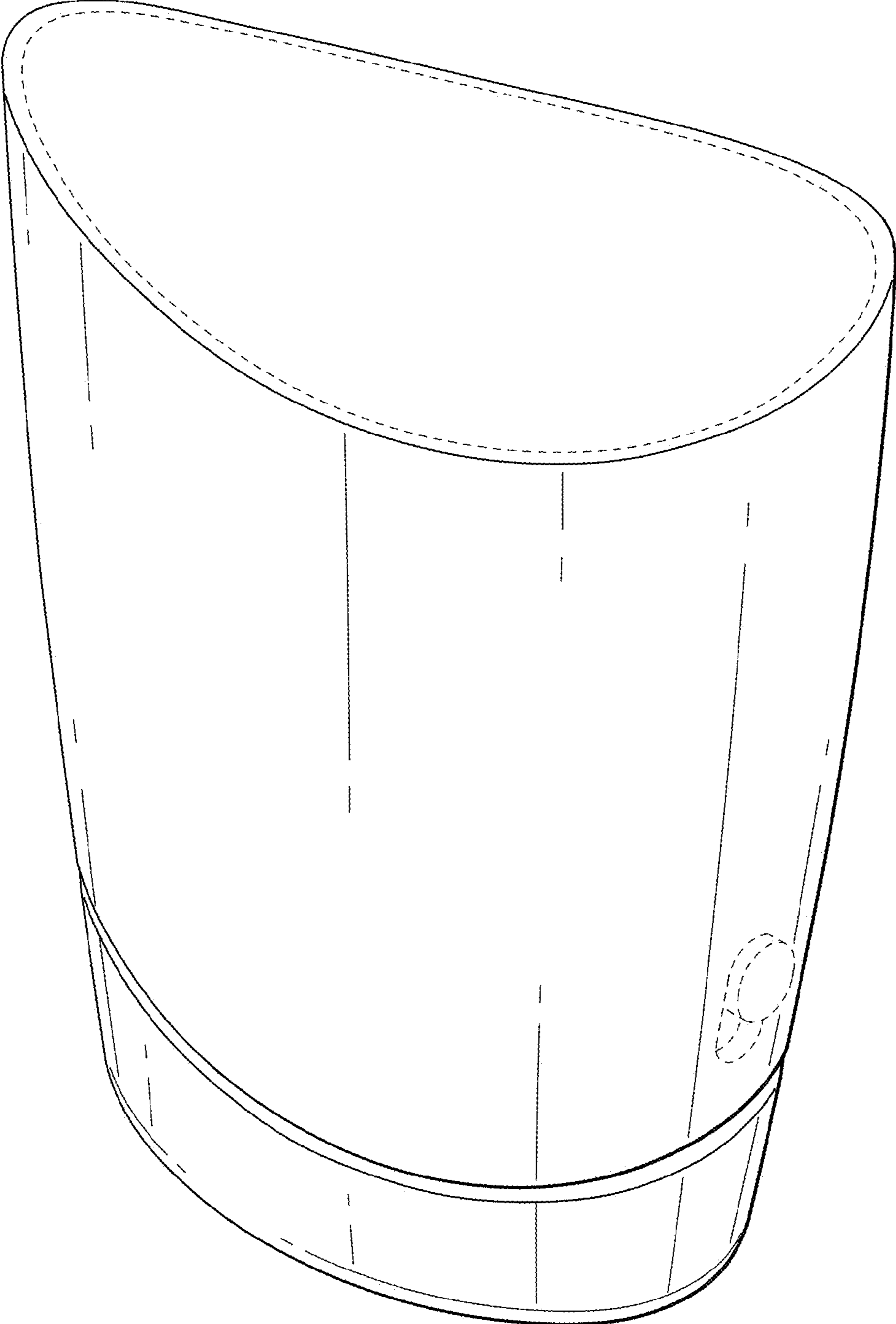

FIG. 1

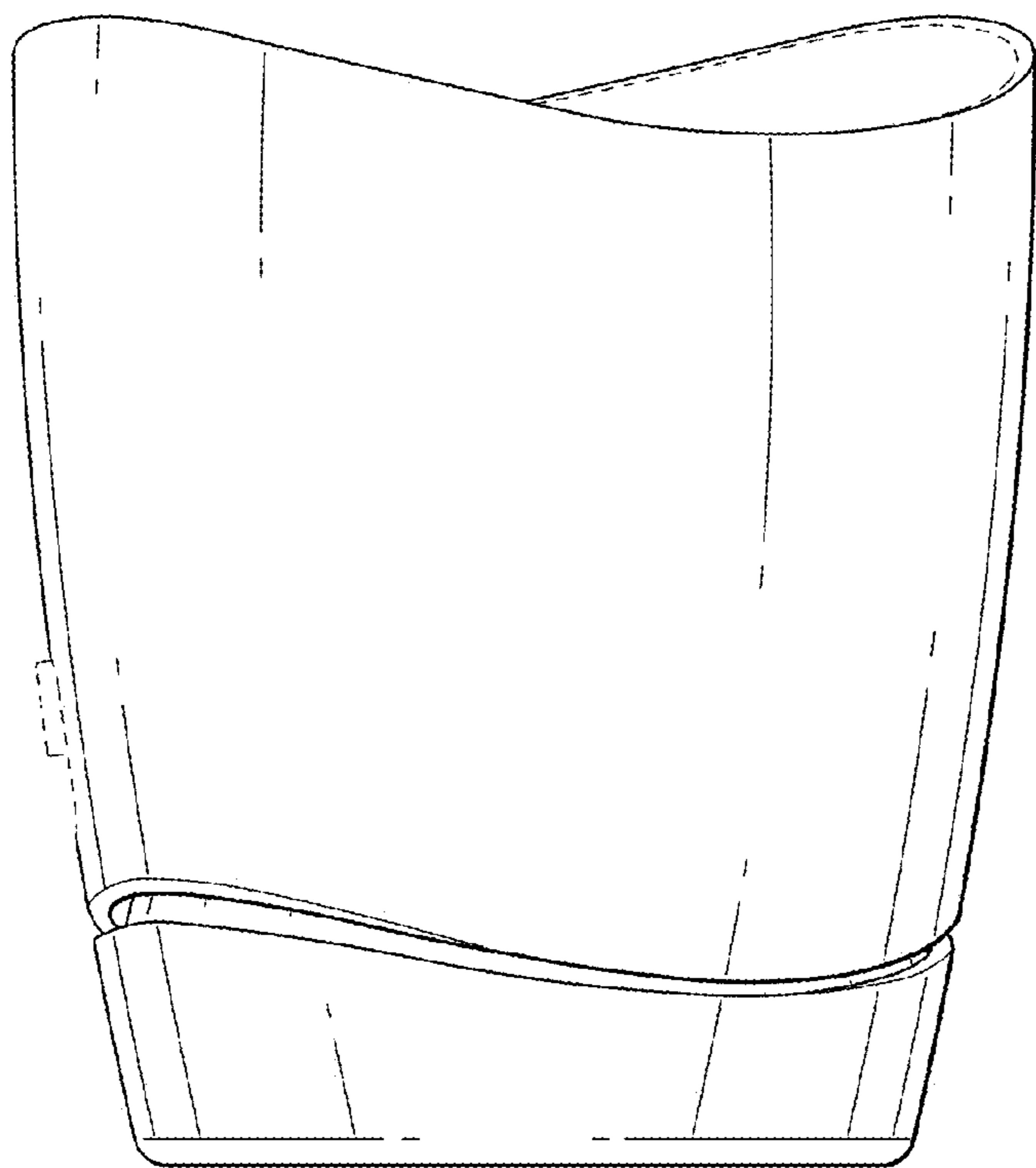

FIG. 2

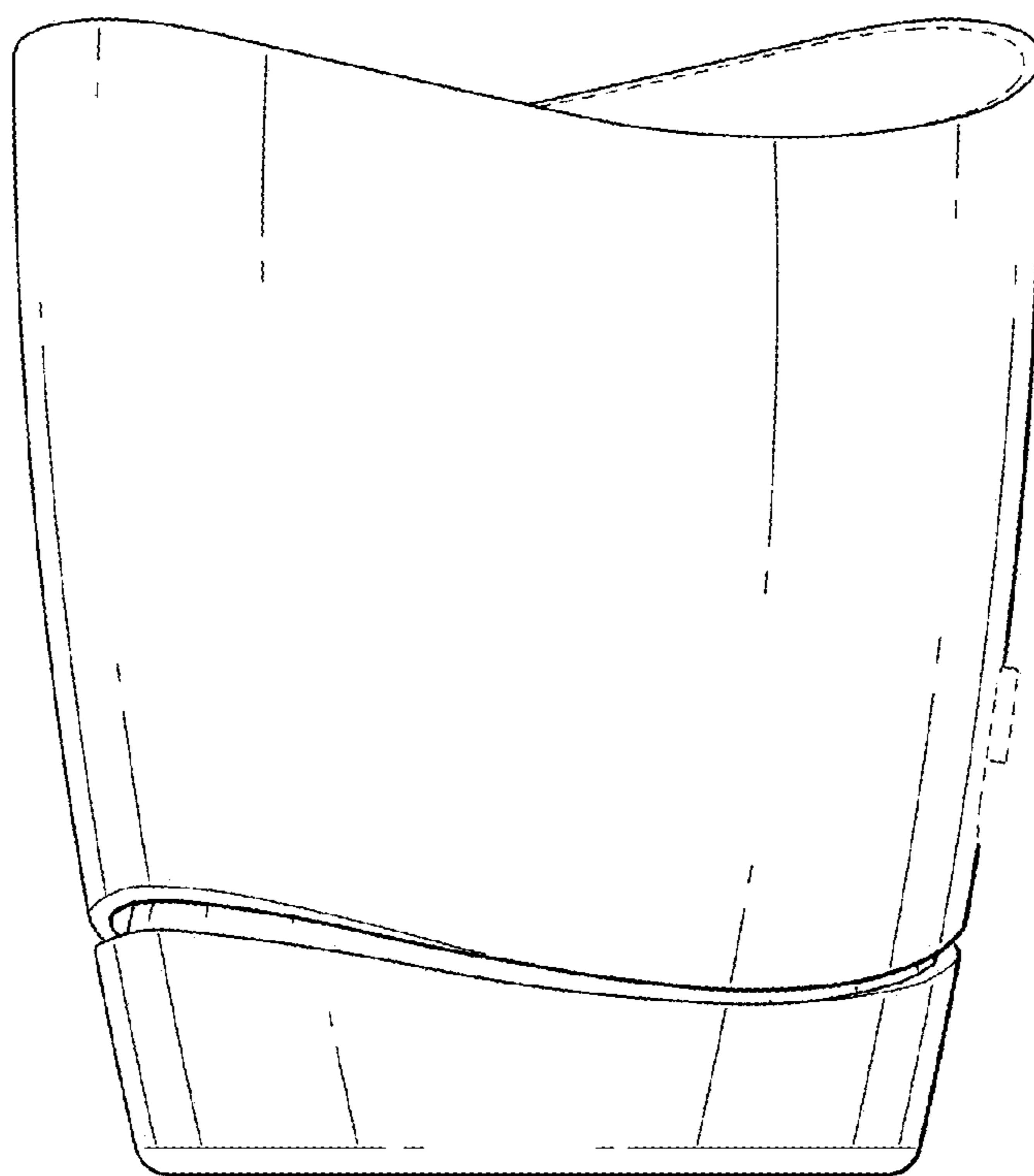

FIG. 3

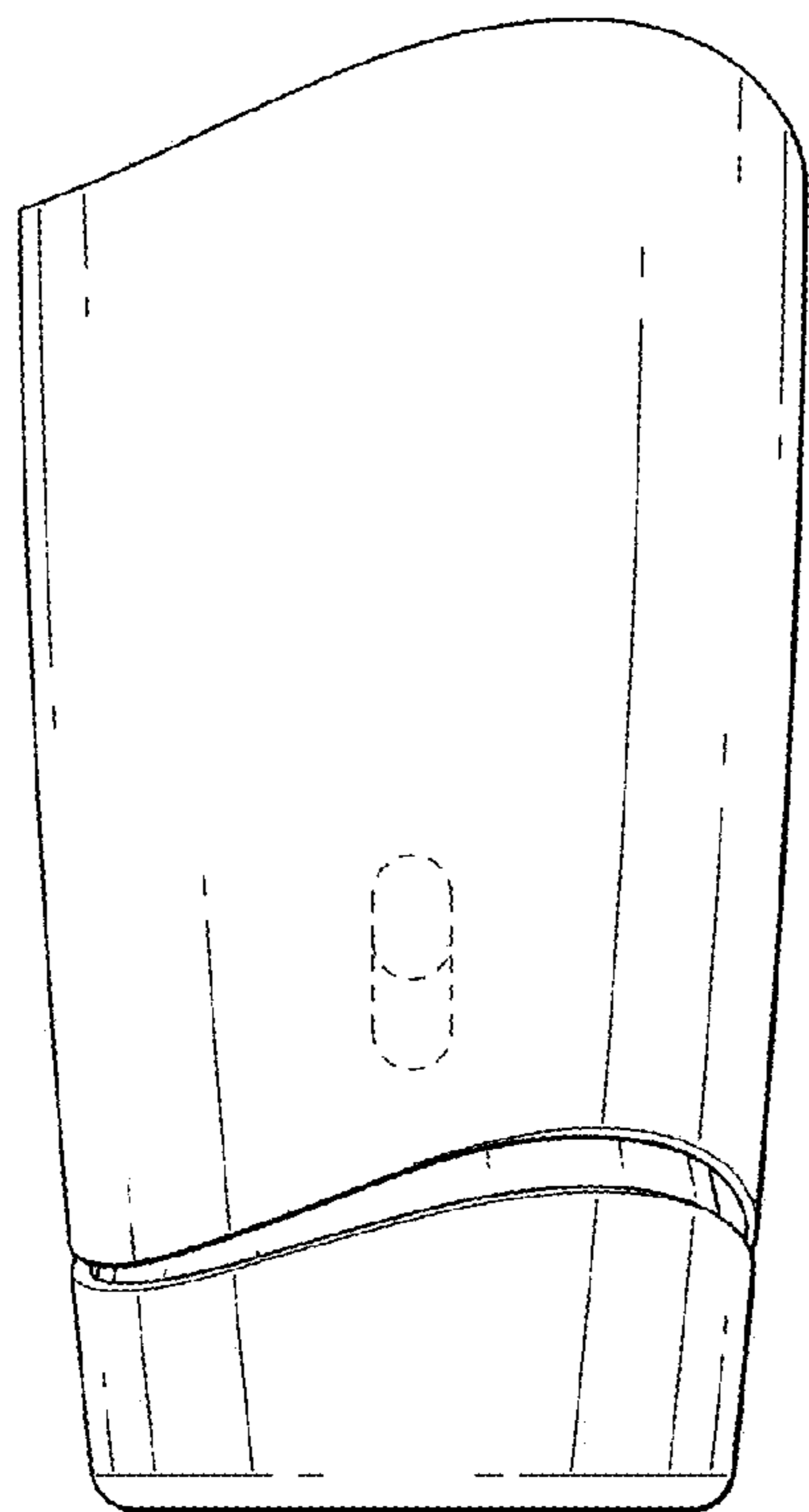

FIG. 4

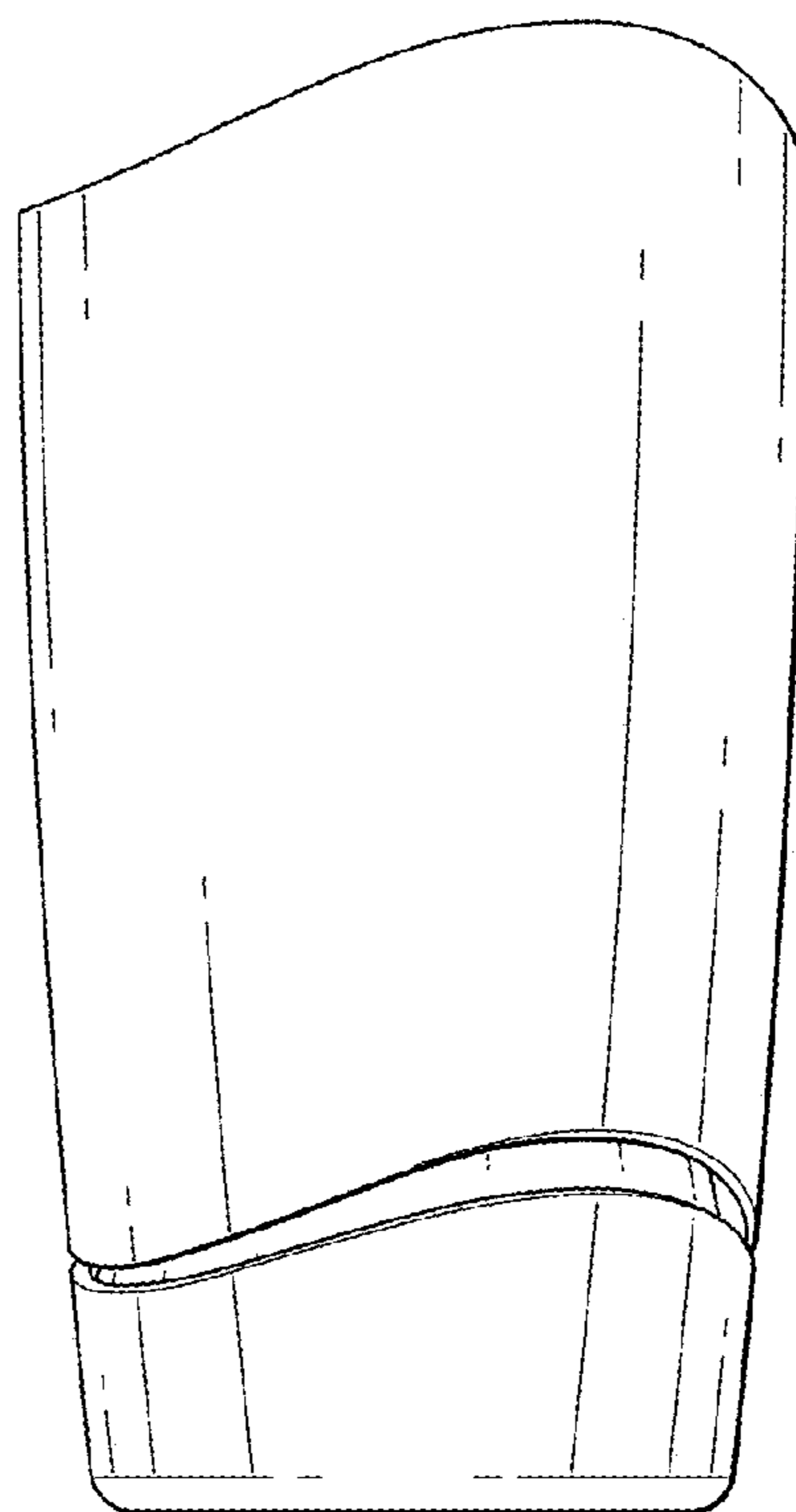

FIG. 5

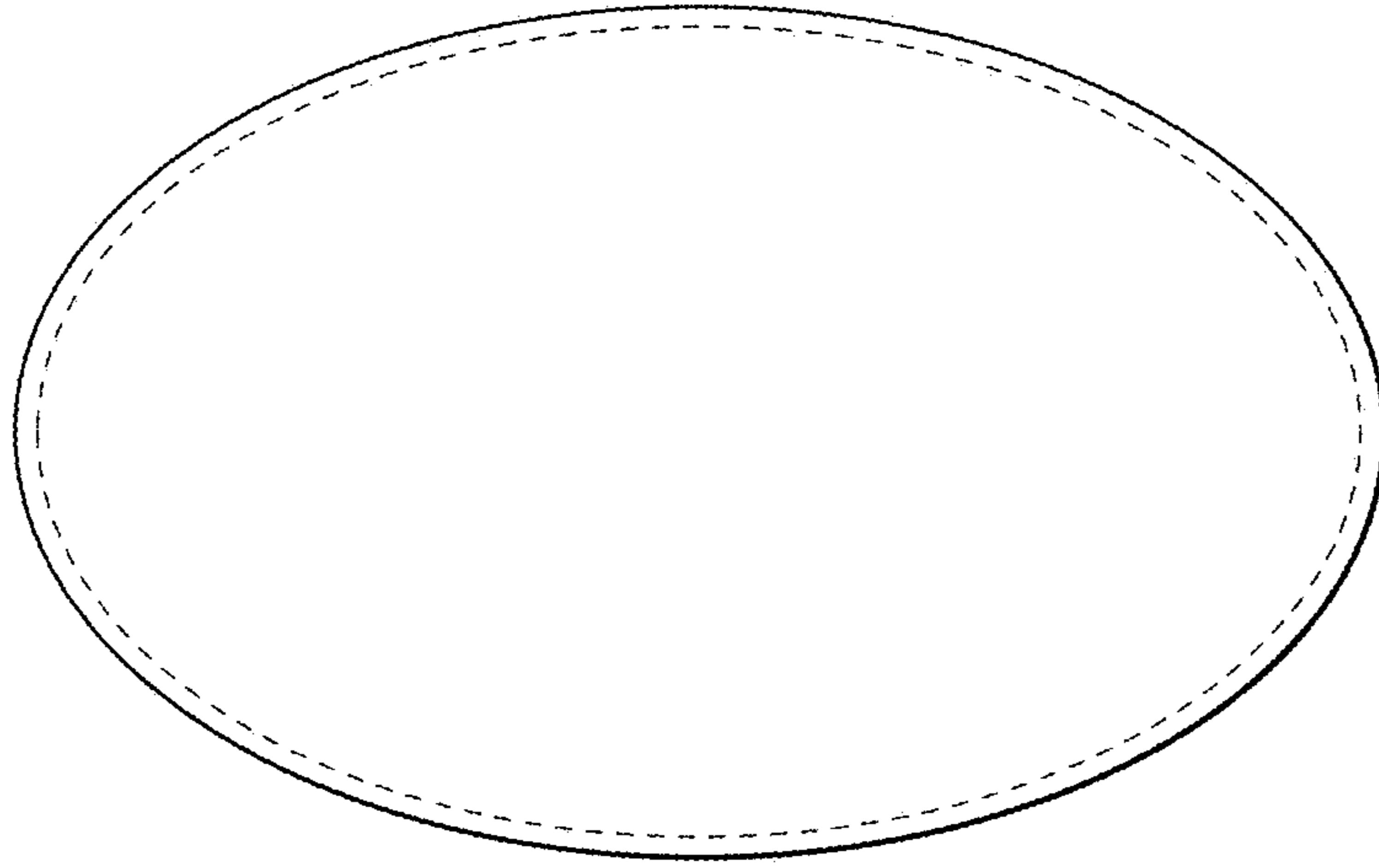

FIG. 6

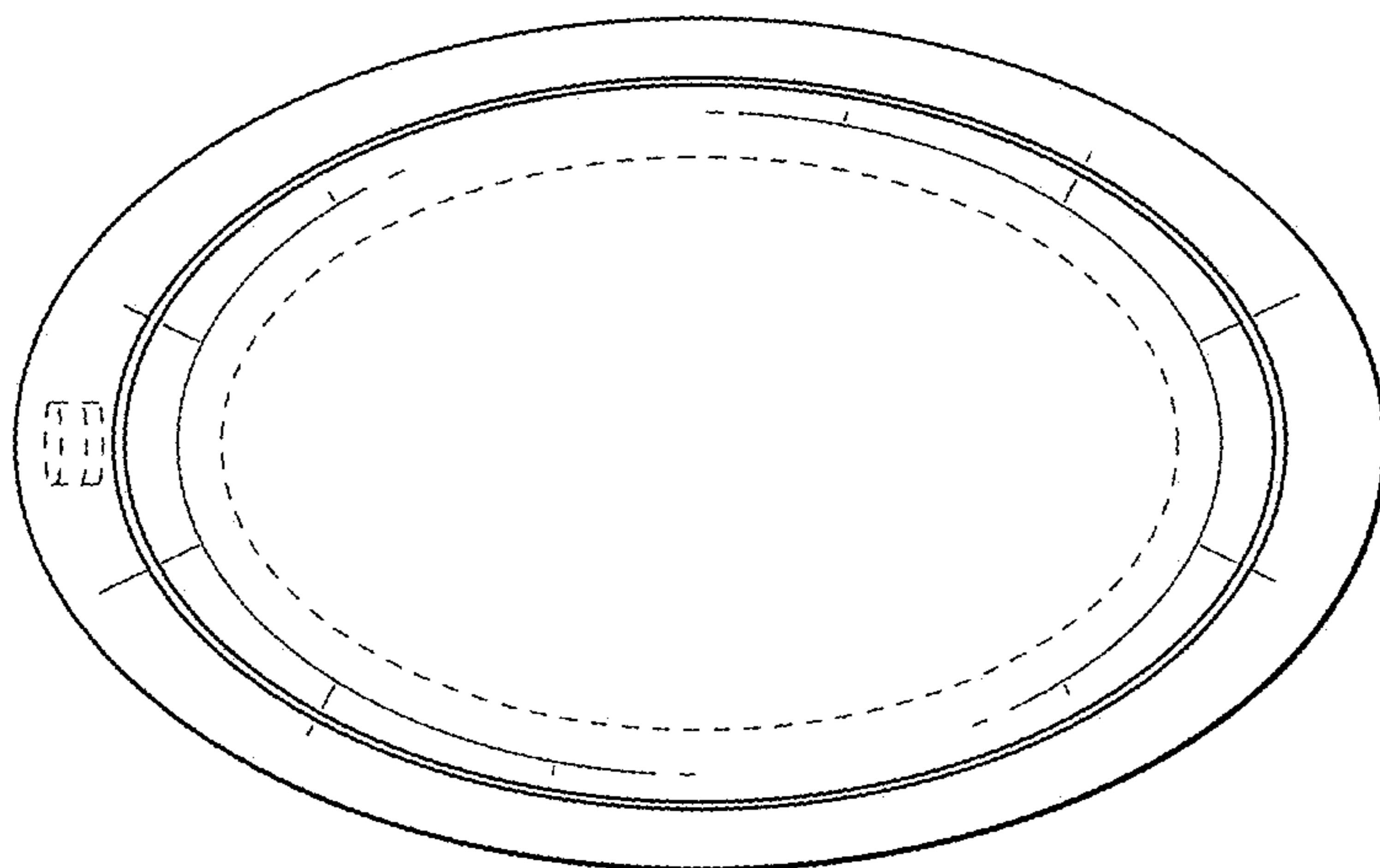

FIG. 7

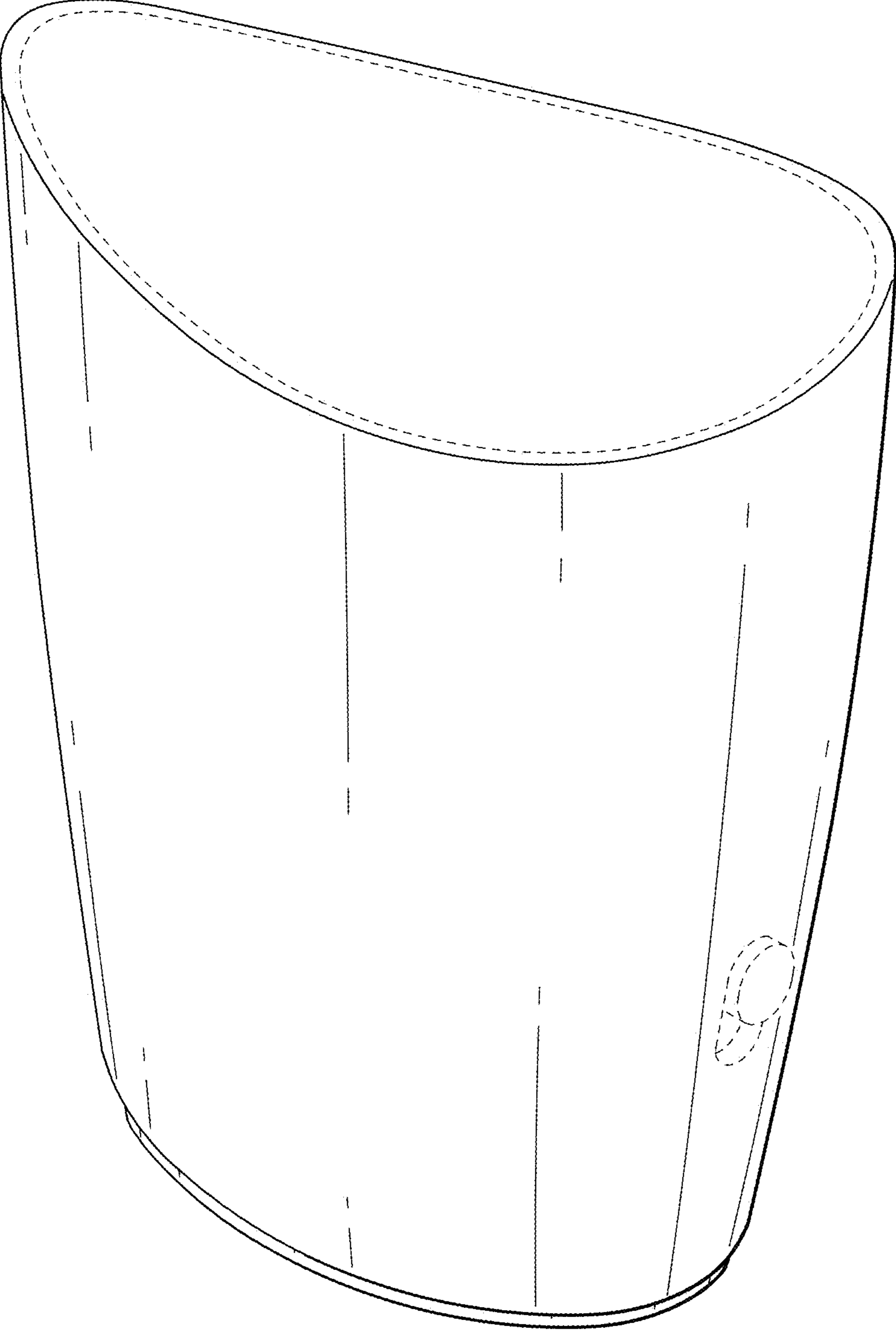

FIG. 8

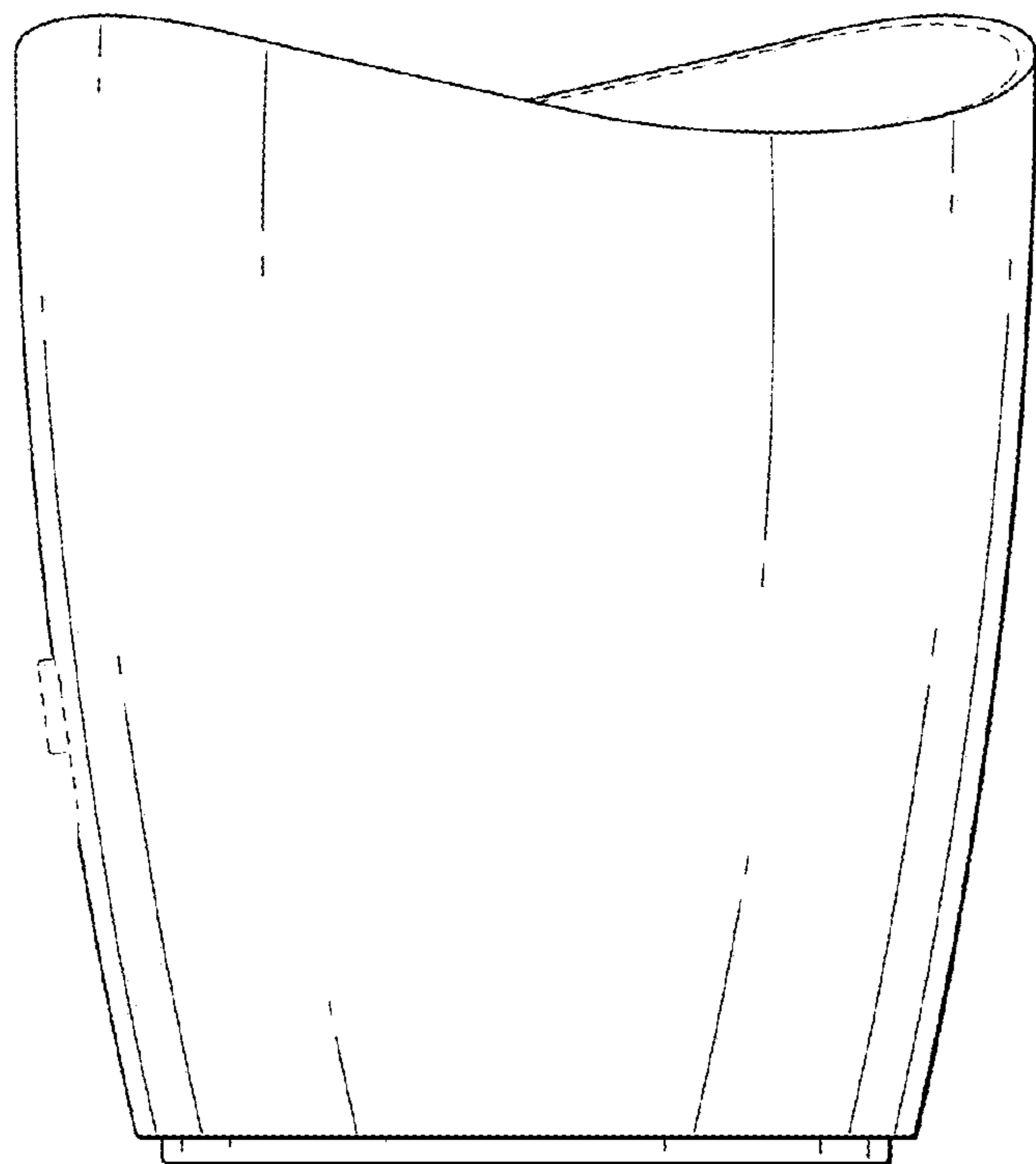

FIG. 9

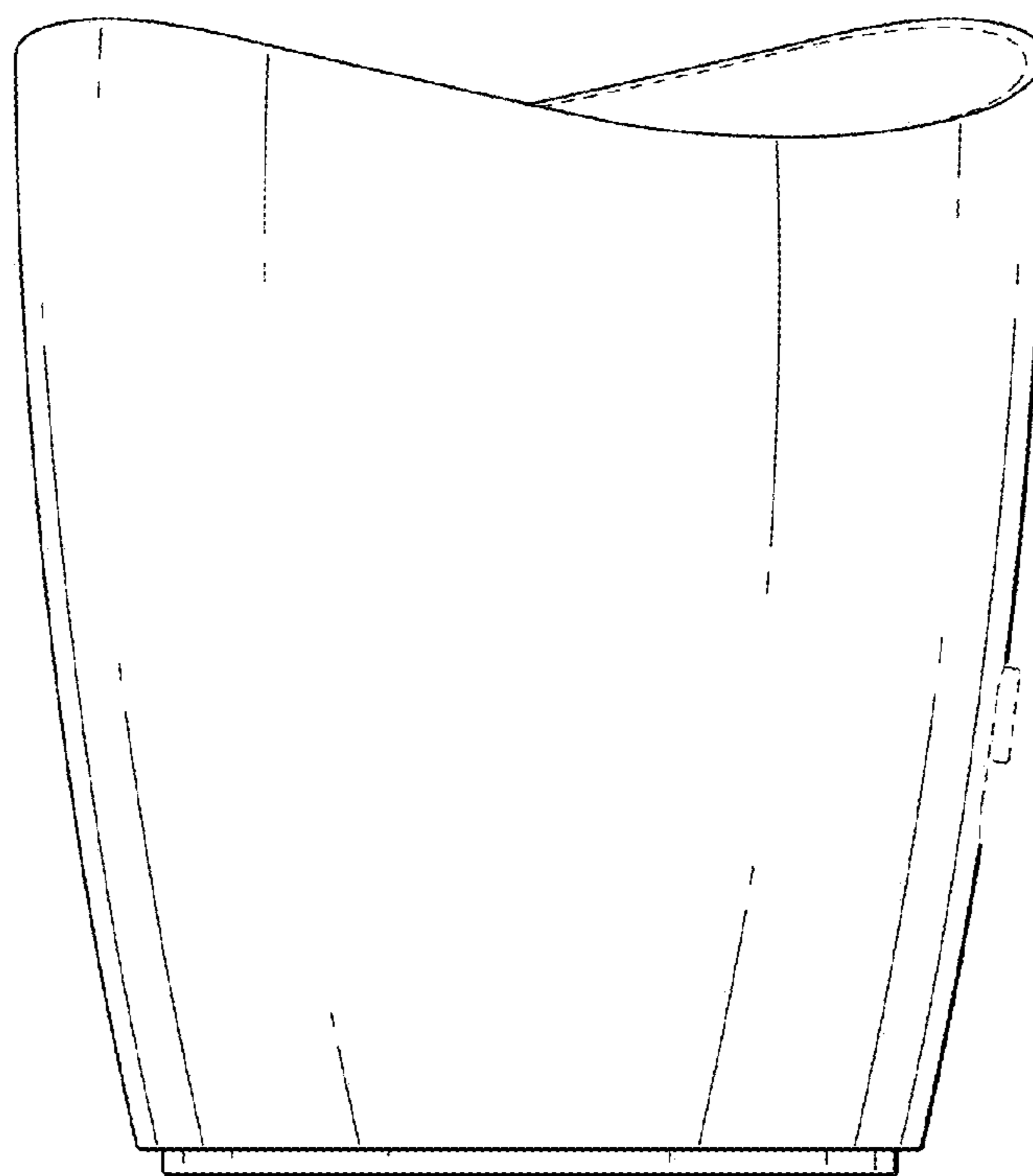

FIG. 10

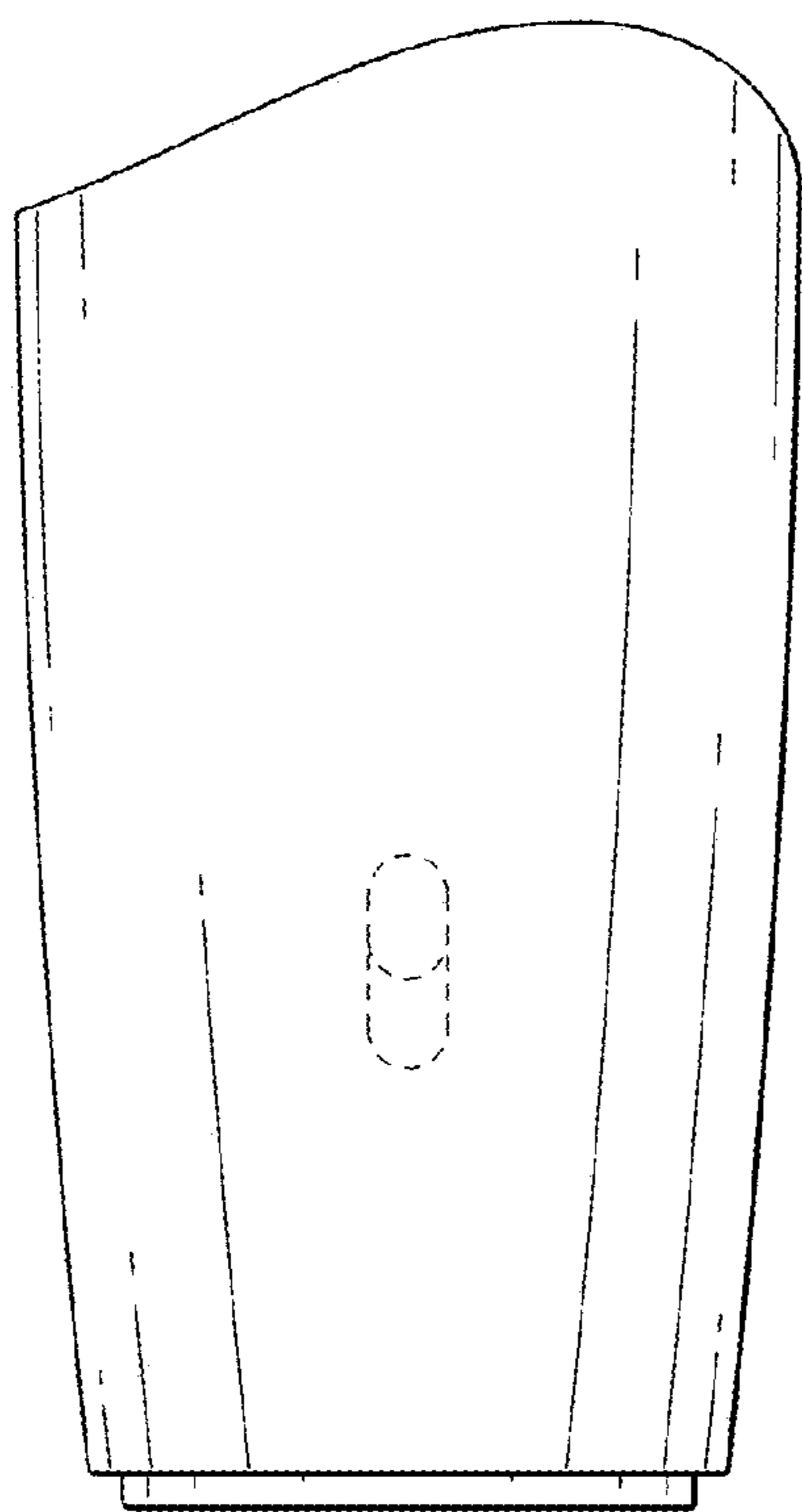

FIG. 11

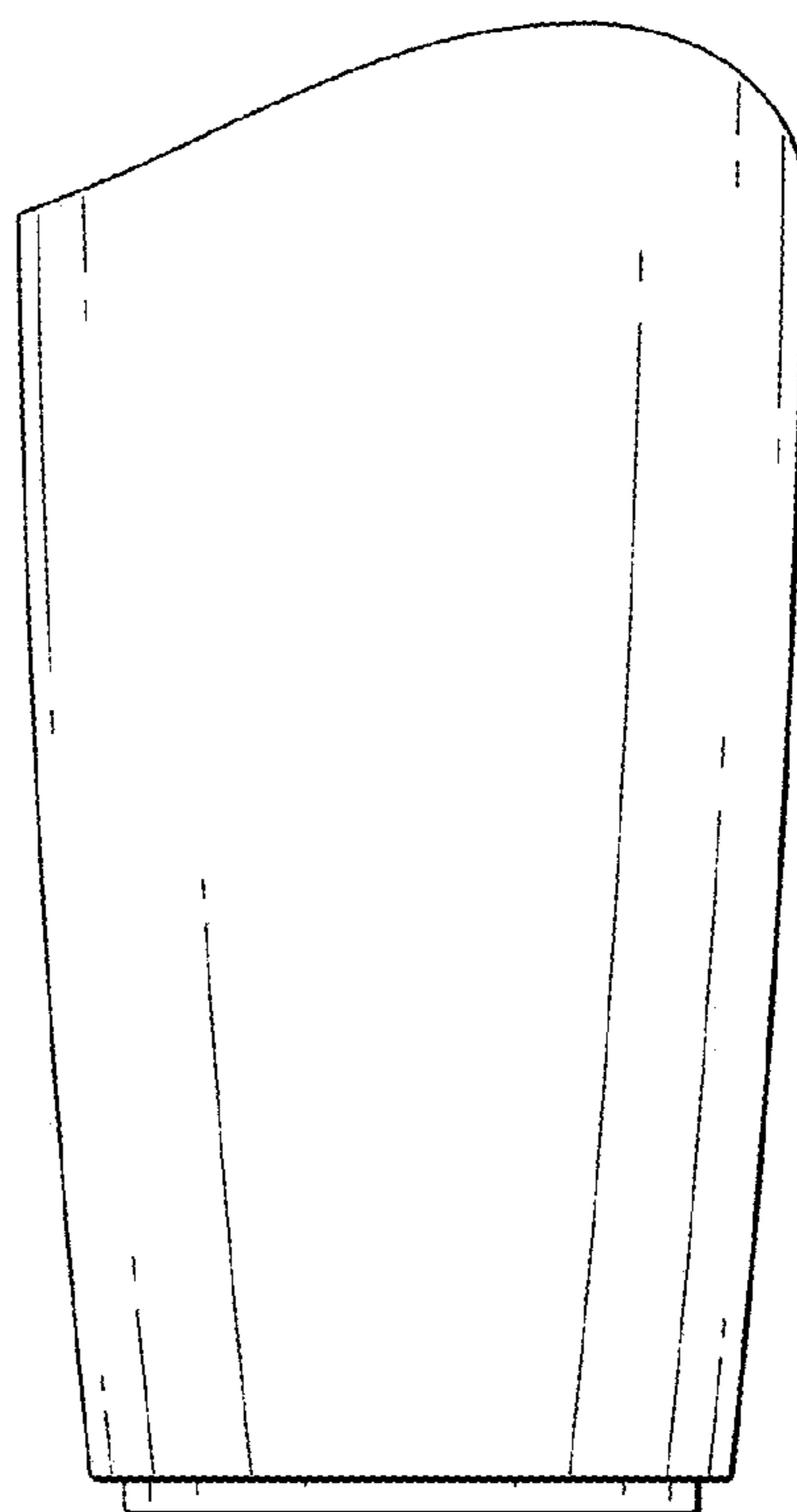

FIG. 12

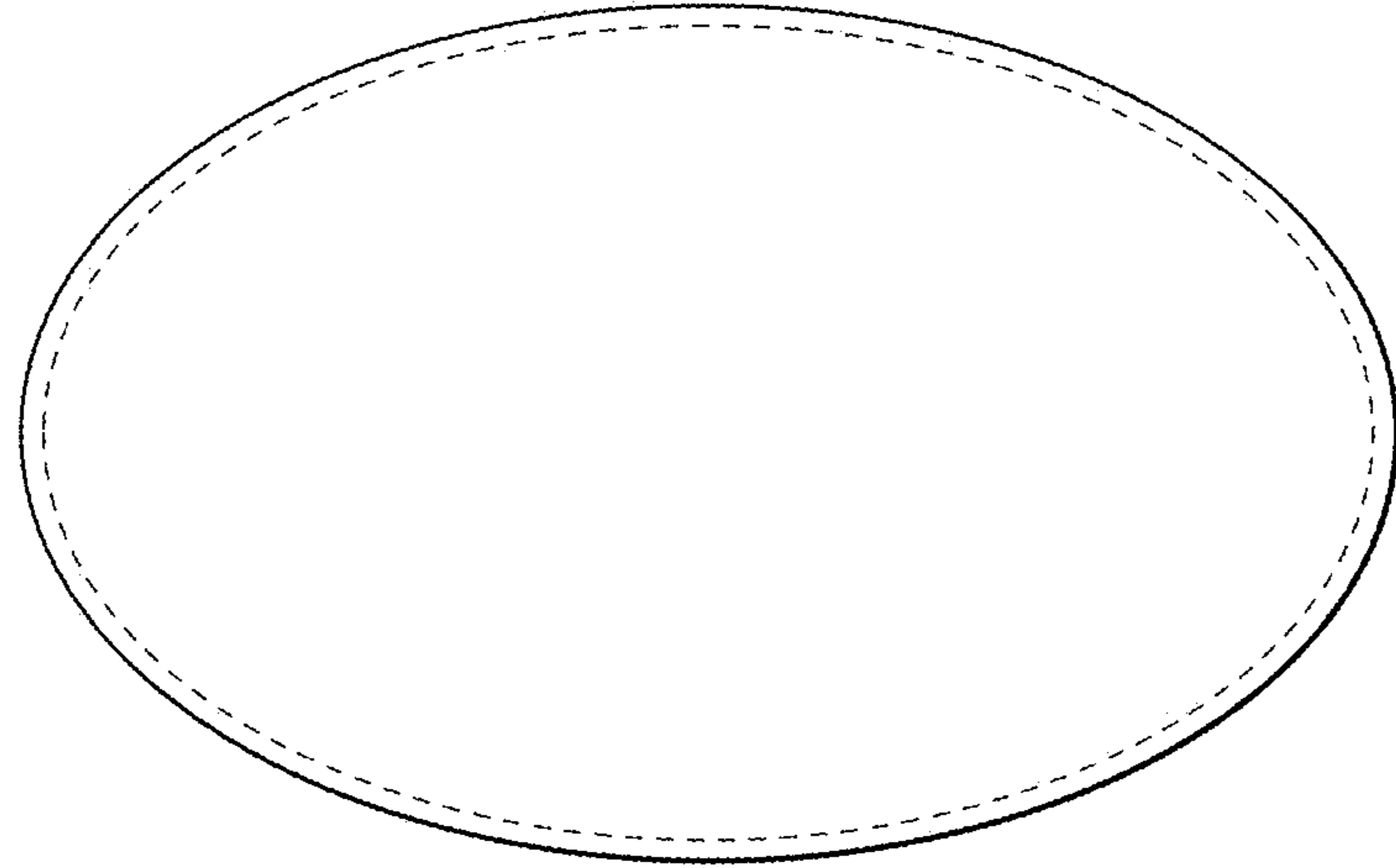

FIG. 13

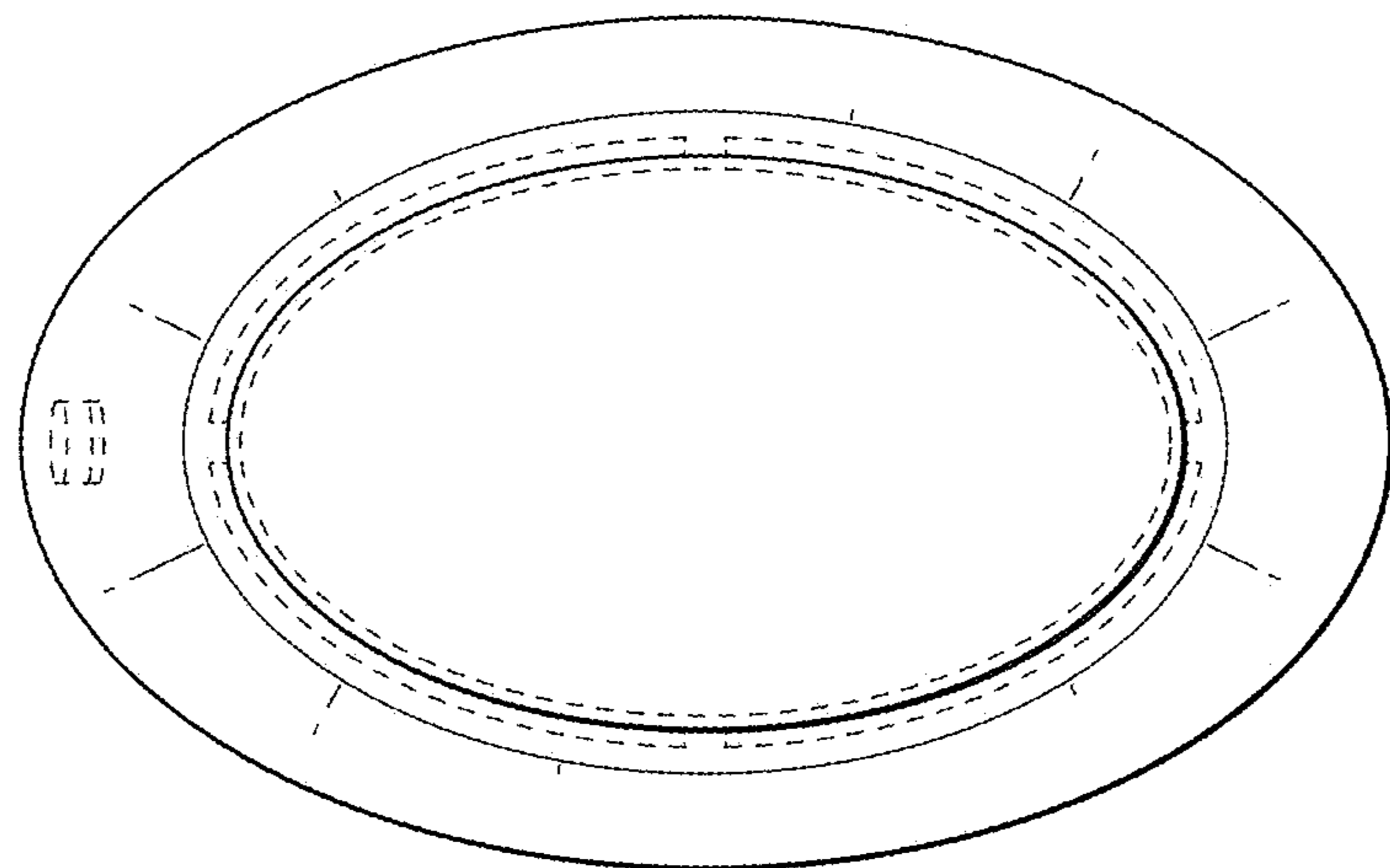

FIG. 14