



US00D707785S

(12) **United States Design Patent**
Seecamp

(10) **Patent No.:** **US D707,785 S**

(45) **Date of Patent:** **** Jun. 24, 2014**

(54) **PISTOL CARTRIDGE**

(71) Applicant: **Lueder Seecamp**, Milford, CT (US)

(72) Inventor: **Lueder Seecamp**, Milford, CT (US)

(73) Assignee: **LWS Ammunition LLC**, Milford, CT (US)

(**) Term: **14 Years**

(21) Appl. No.: **29/433,404**

(22) Filed: **Sep. 28, 2012**

(51) **LOC (10) Cl.** **22-03**

(52) **U.S. Cl.**
USPC **D22/116**

(58) **Field of Classification Search**
USPC D22/115, 116; 463/2; 102/385, 430,
102/439, 445, 501-520; 86/10, 19.5, 51-54
See application file for complete search history.

(56) **References Cited**

U.S. PATENT DOCUMENTS

376,302 A * 1/1888 Gregg
693,329 A 2/1902 Neubauer

(Continued)

FOREIGN PATENT DOCUMENTS

DE 2820530 A1 11/1979
DE 4321041 A1 1/1995
EP 2453200 A1 5/2012

OTHER PUBLICATIONS

International Search Report and Written Opinion of the International Searching Authority Application No. PCT/US2012/059852 Completed: Jun. 13, 2013; Mailing Date: Jun. 25, 2013 8 pages.

Primary Examiner — Michael A Pratt

(74) *Attorney, Agent, or Firm* — St. Onge Steward Johnston & Reens LLC

(57) **CLAIM**

The ornamental design for a pistol cartridge, as shown and described.

DESCRIPTION

FIG. 1 is a top front and right side isometric view of a first embodiment of a pistol cartridge in accordance with the new design;

FIG. 2 is a bottom plan view thereof;

FIG. 3 is a top plan view thereof;

FIG. 4 is a right side elevation view thereof, the left side view being a mirror image thereof;

FIG. 5 is a rear and left side perspective view thereof; and

FIG. 6 is a front elevation view thereof, the rear view being a mirror image view thereof.

FIG. 7 is a top front and right side isometric view of a second embodiment of a pistol cartridge in accordance with the new design;

FIG. 8 is a bottom plan view thereof;

FIG. 9 is a top plan view thereof;

FIG. 10 is a right side elevation view thereof, the left side view being a mirror image thereof;

FIG. 11 is a rear and left side perspective view thereof; and

FIG. 12 is a front elevation view thereof, the rear view being a mirror image view thereof.

FIG. 13 is a top front and right side isometric view of a third embodiment of a pistol cartridge in accordance with the new design;

FIG. 14 is a bottom plan view thereof;

FIG. 15 is a top plan view thereof;

FIG. 16 is a right side elevation view thereof, the left side view being a mirror image thereof;

FIG. 17 is a rear and left side perspective view thereof; and

FIG. 18 is a front elevation view thereof, the rear view being a mirror image view thereof.

FIG. 19 is a top front and right side isometric view of a fourth embodiment of a pistol cartridge in accordance with the new design;

FIG. 20 is a bottom plan view thereof;

FIG. 21 is a top plan view thereof;

FIG. 22 is a right side elevation view thereof, the left side view being a mirror image thereof;

FIG. 23 is a rear and left side perspective view thereof; and,

FIG. 24 is a front elevation view thereof, the rear view being a mirror image view thereof.

1 Claim, 8 Drawing Sheets

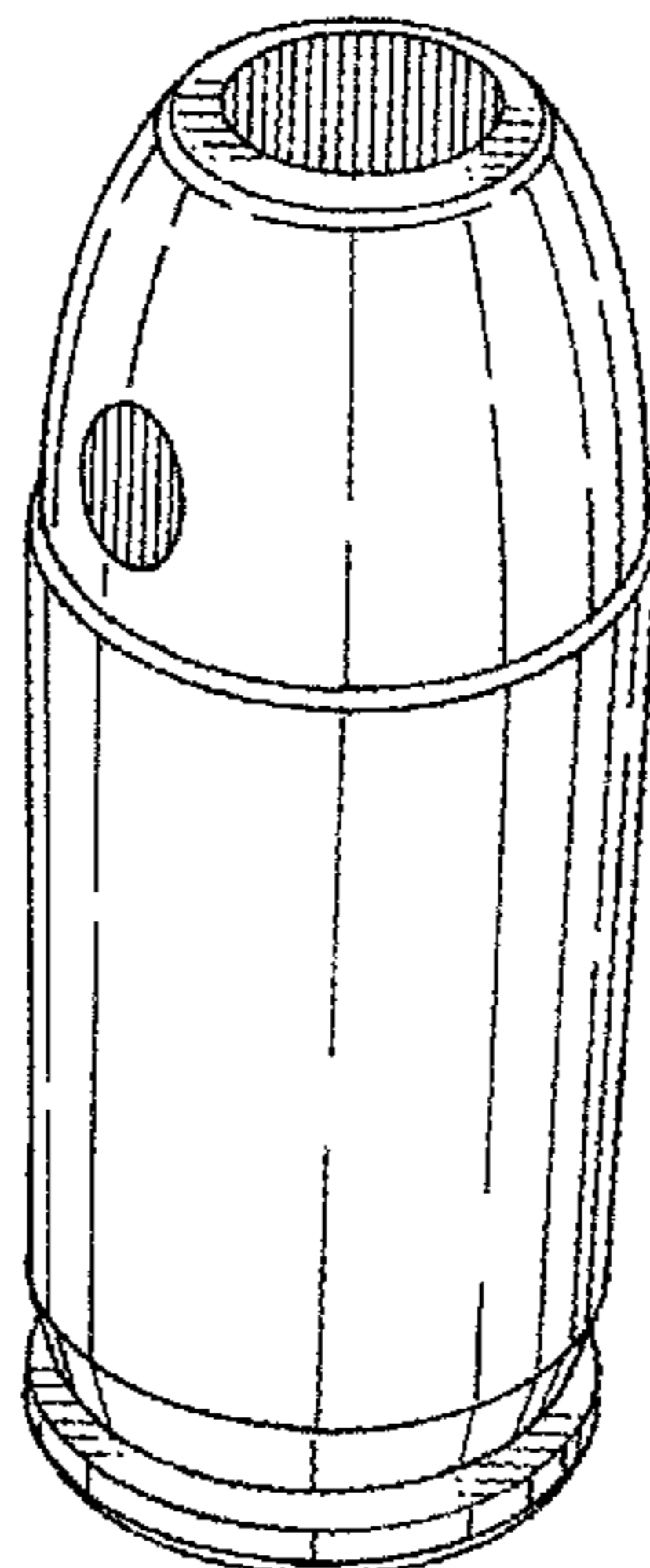

(56)

References Cited

U.S. PATENT DOCUMENTS

843,017 A	2/1907	Hoxie	5,528,989 A	6/1996	Briese
1,073,349 A	9/1913	Hoagland	5,621,186 A	4/1997	Carter
1,135,357 A	4/1915	Clyne	5,698,815 A	12/1997	Ragner
1,681,295 A	8/1928	Johnson	5,760,329 A	6/1998	Baum et al.
1,715,788 A	6/1929	Rosseau	5,811,723 A	9/1998	Stone
3,580,179 A	5/1971	Gawlick et al.	5,945,629 A	8/1999	Schildknecht et al.
3,791,303 A	2/1974	Sweeney et al.	6,145,441 A	11/2000	Woodall et al.
3,865,038 A	2/1975	Barr	6,176,186 B1	1/2001	Engel
3,866,536 A	2/1975	Greenberg	6,178,890 B1	1/2001	Burczynski
3,949,677 A	4/1976	Voss	6,182,574 B1	2/2001	Giannoni
4,091,736 A	5/1978	Mizelle	6,213,022 B1	4/2001	Pullum
4,136,616 A	1/1979	Schirneker	6,378,439 B1	4/2002	Saxby
4,245,557 A	1/1981	Knappworst	6,453,820 B1	9/2002	Anderson
4,348,958 A	9/1982	Day	6,546,874 B2	4/2003	Vasel et al.
4,610,061 A	9/1986	Halverson	6,805,057 B2	10/2004	Carr et al.
4,867,065 A	9/1989	Kaltmann	6,971,315 B2	12/2005	Knappworst et al.
4,947,755 A	8/1990	Burczynski	7,178,462 B2	2/2007	Beasley
5,133,261 A	7/1992	Kelsey, Jr.	7,484,459 B2	2/2009	Fichot et al.
5,225,628 A	7/1993	Heiny	2002/0056397 A1	5/2002	Carr et al.
5,275,110 A	1/1994	Flatau	2005/0126422 A1	6/2005	Lamm
			2006/0096491 A1	5/2006	Fichot et al.
			2011/0056404 A1	3/2011	Masinelli

* cited by examiner

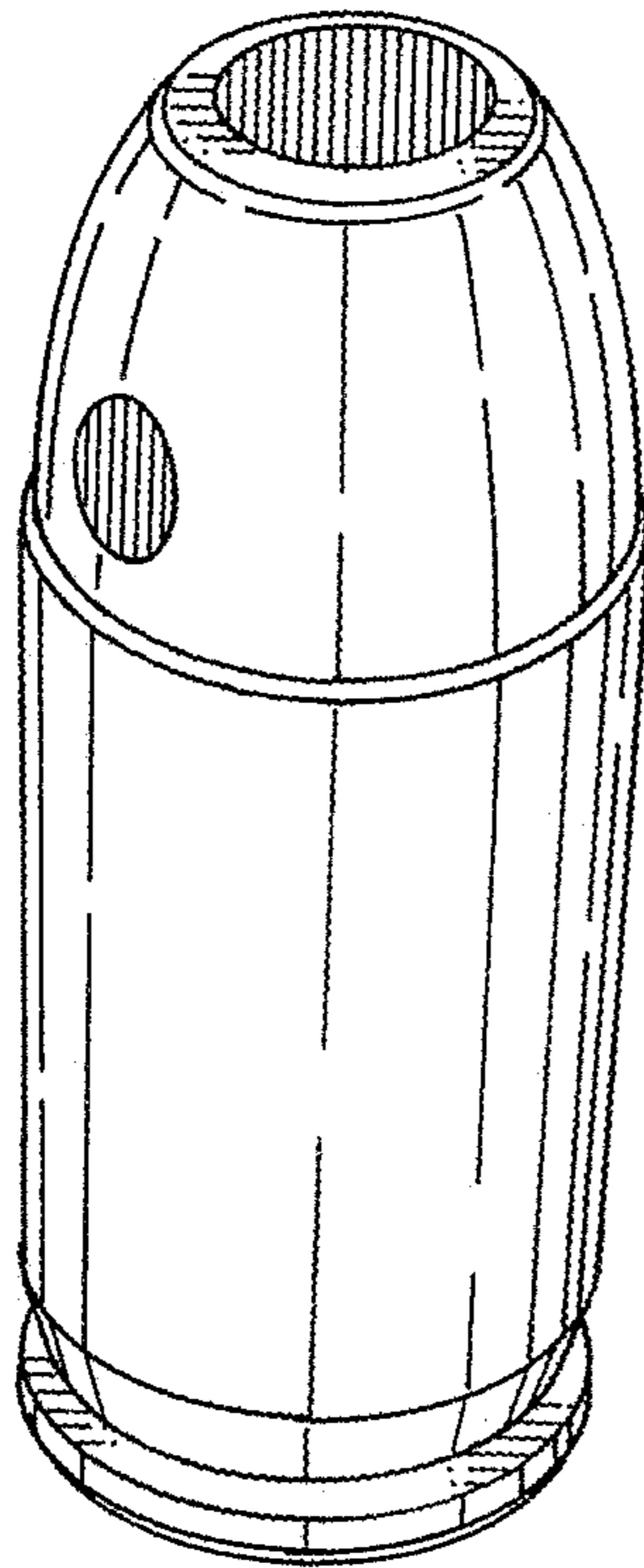

FIG. 1

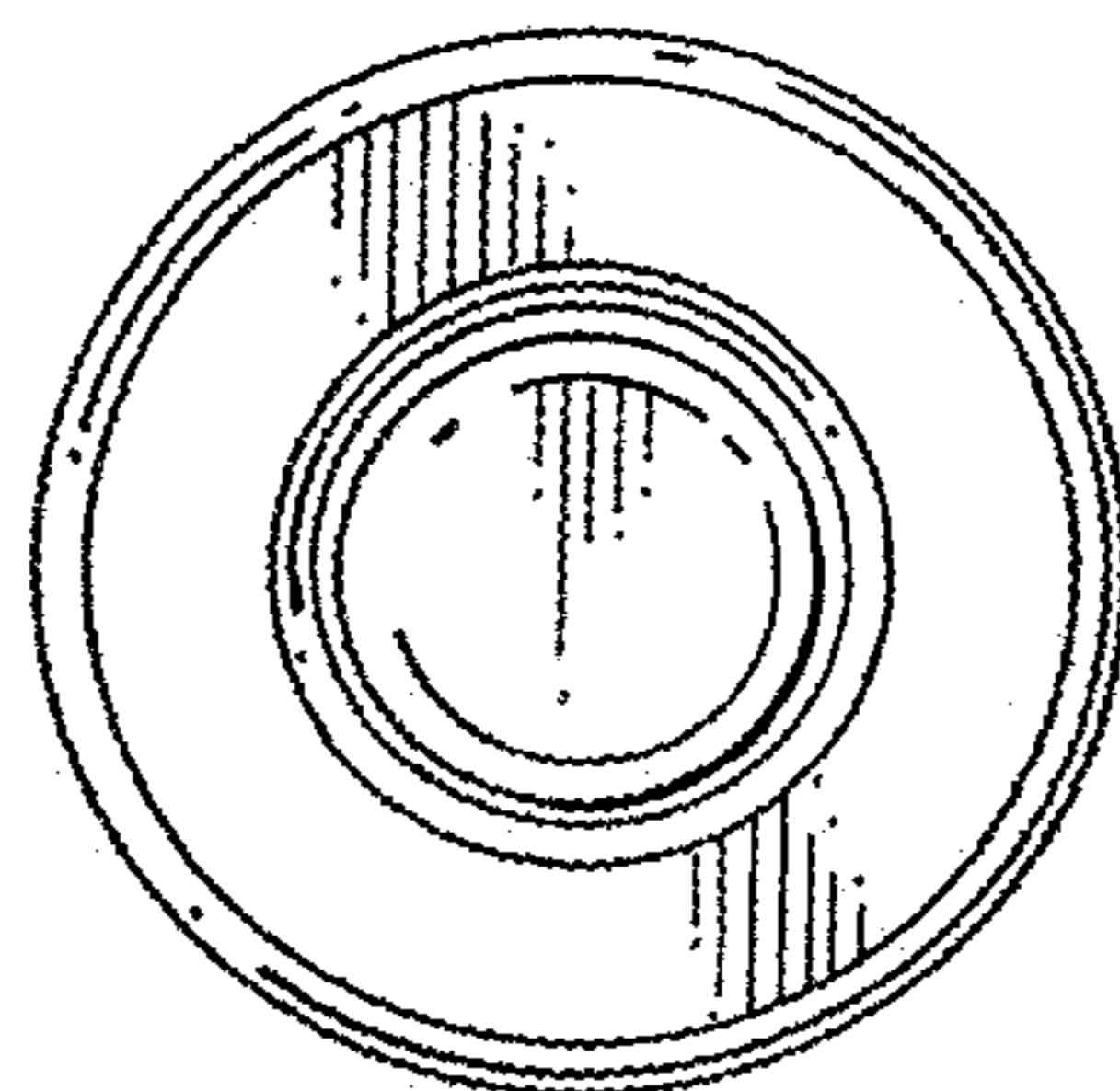

FIG. 2

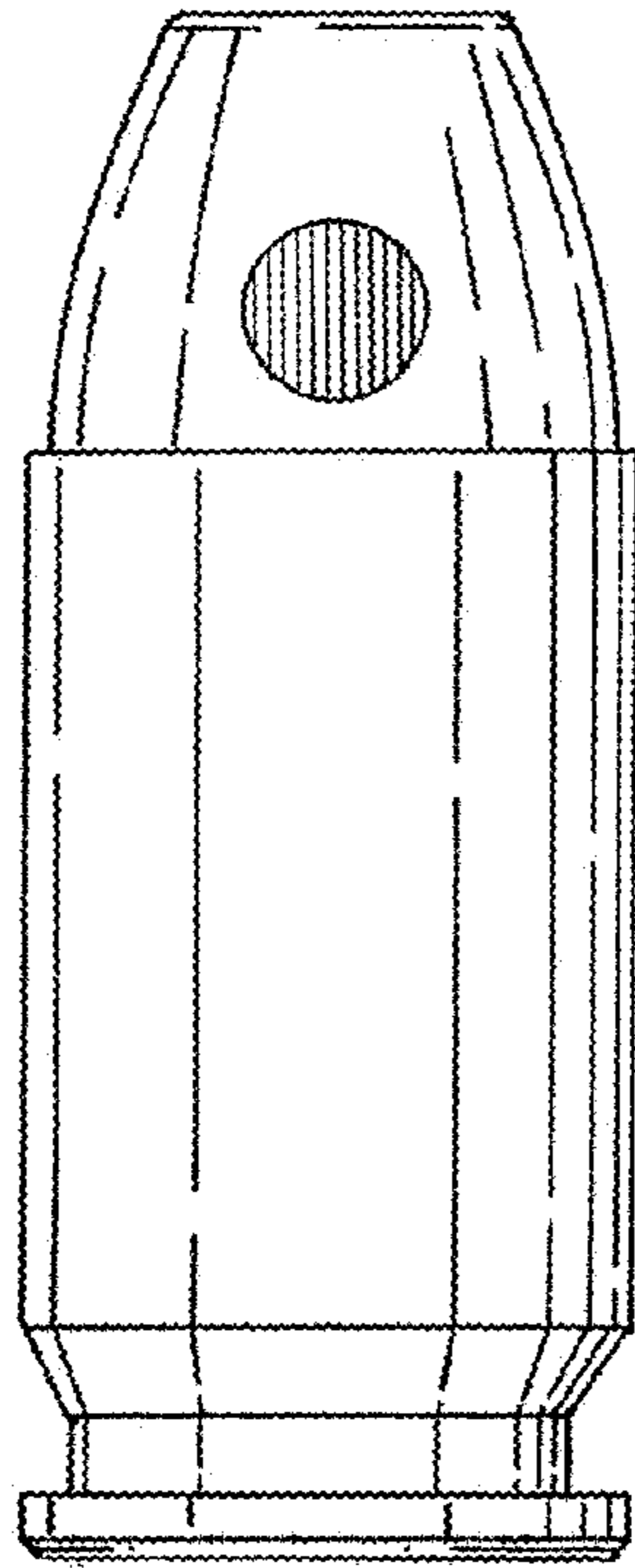

FIG. 4

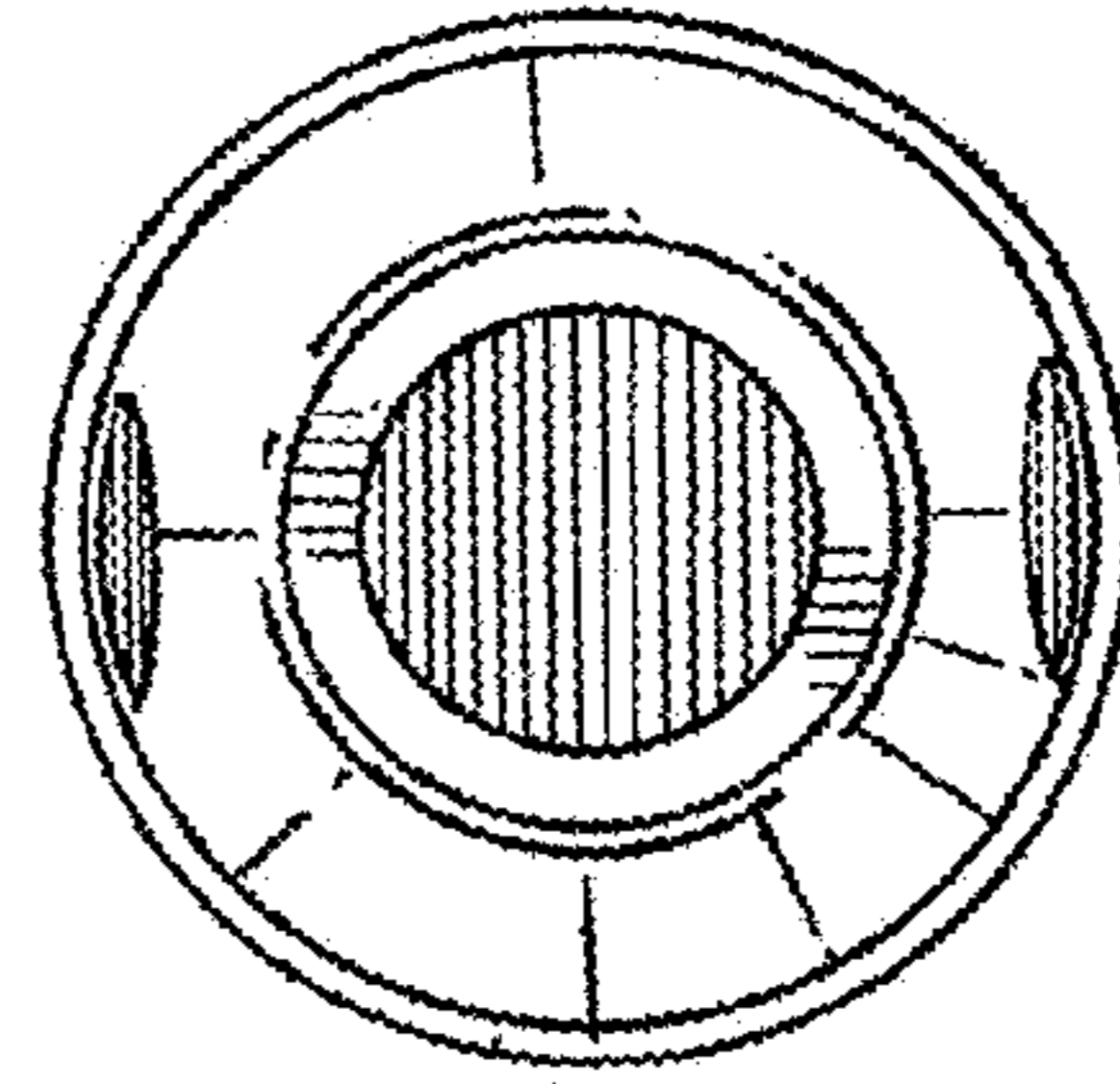

FIG. 3

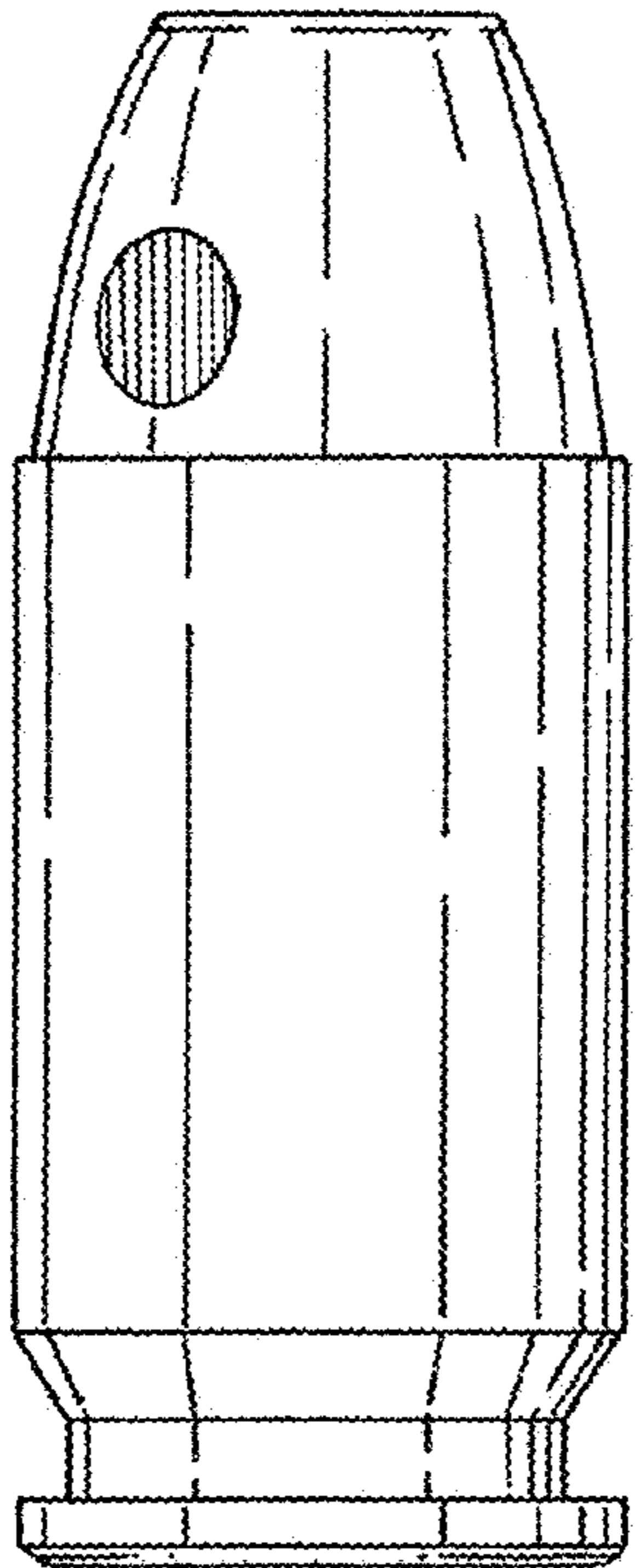

FIG. 5

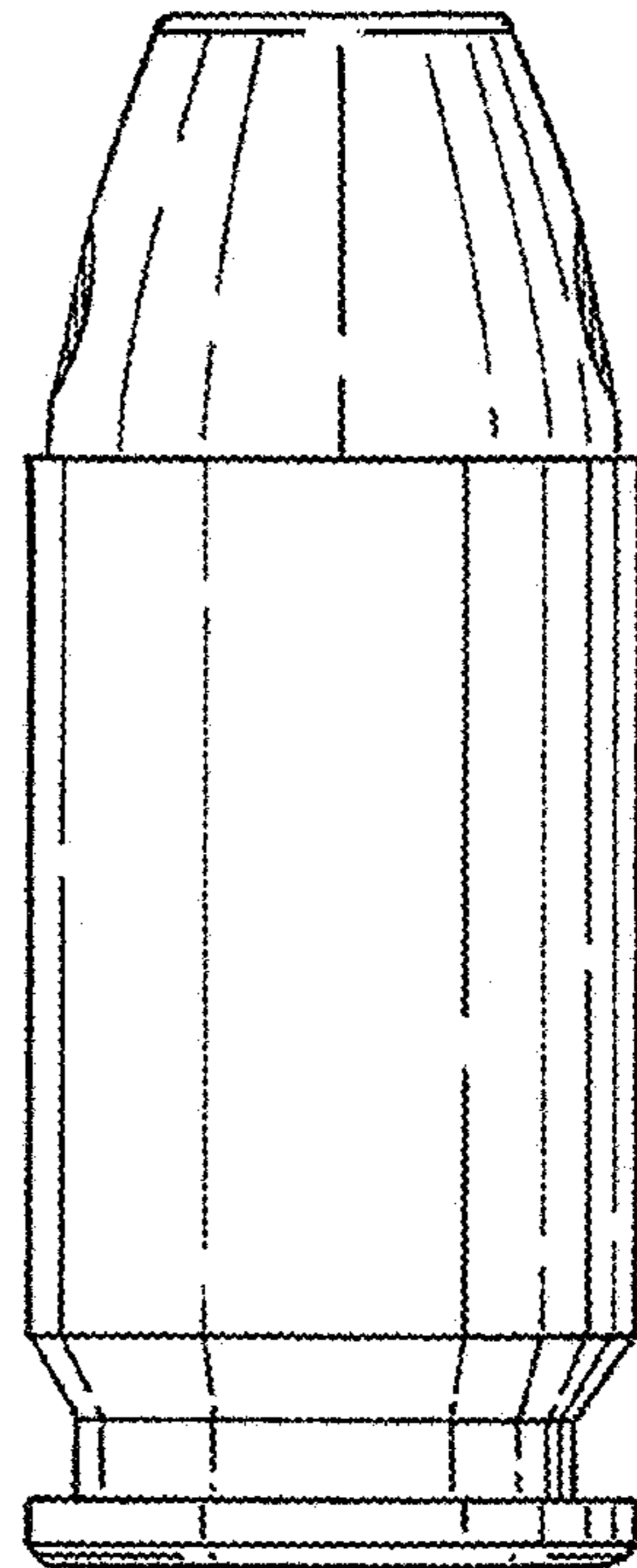

FIG. 6

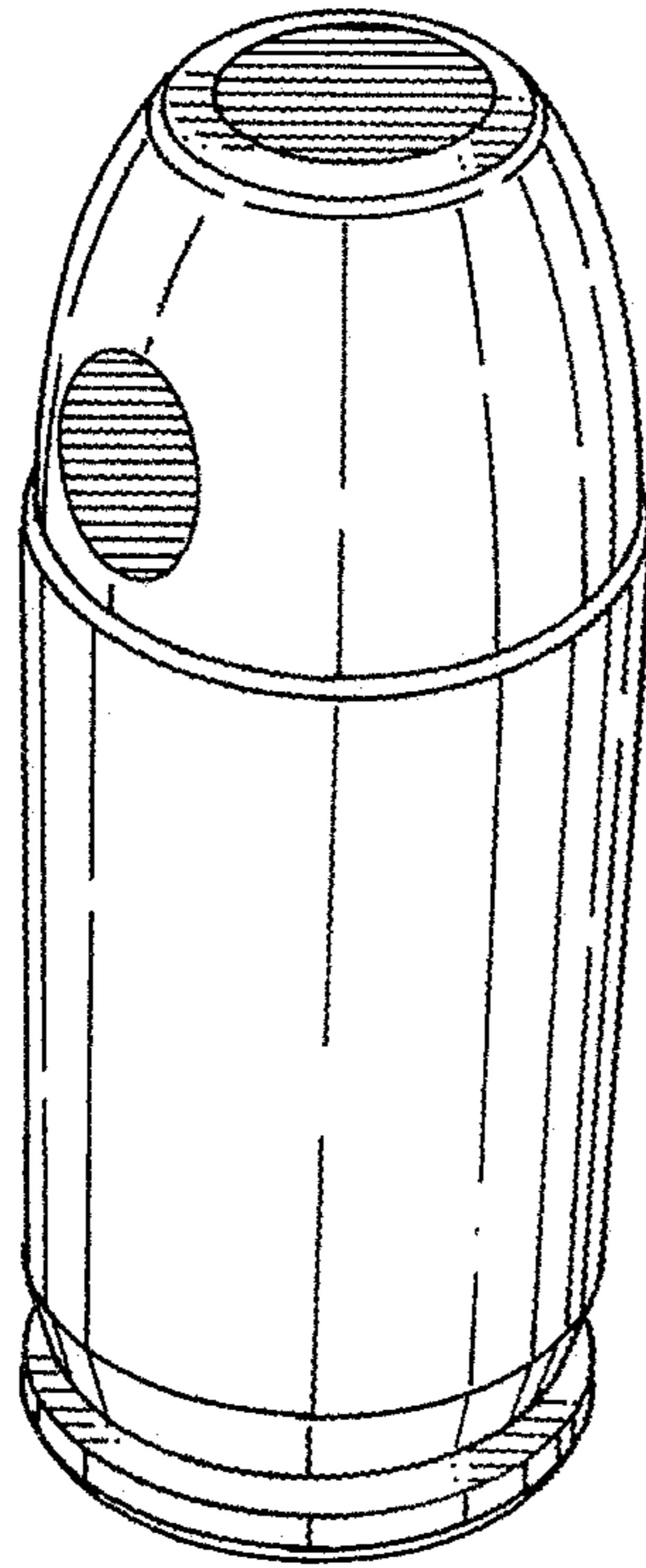

FIG. 7

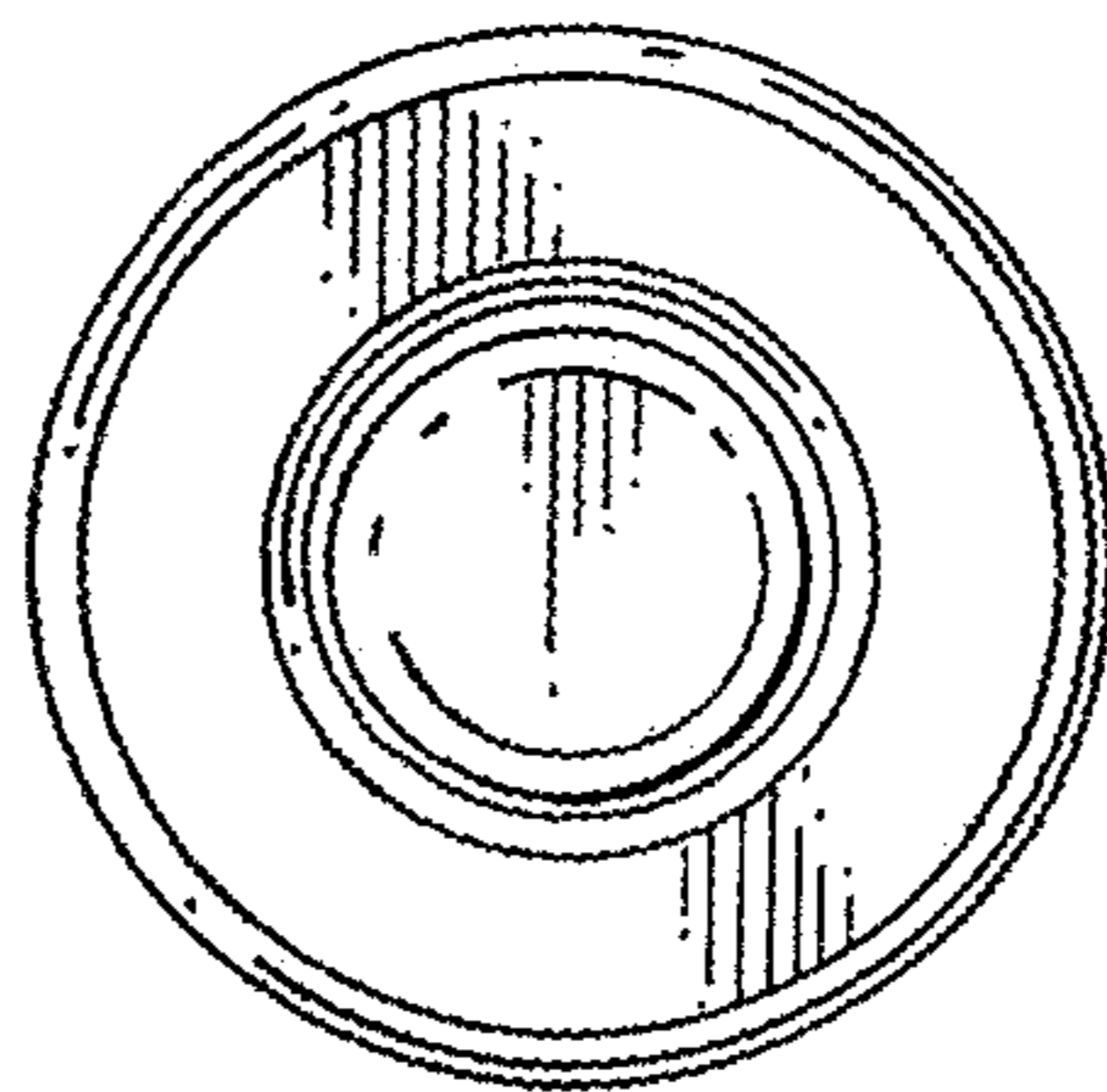

FIG. 8

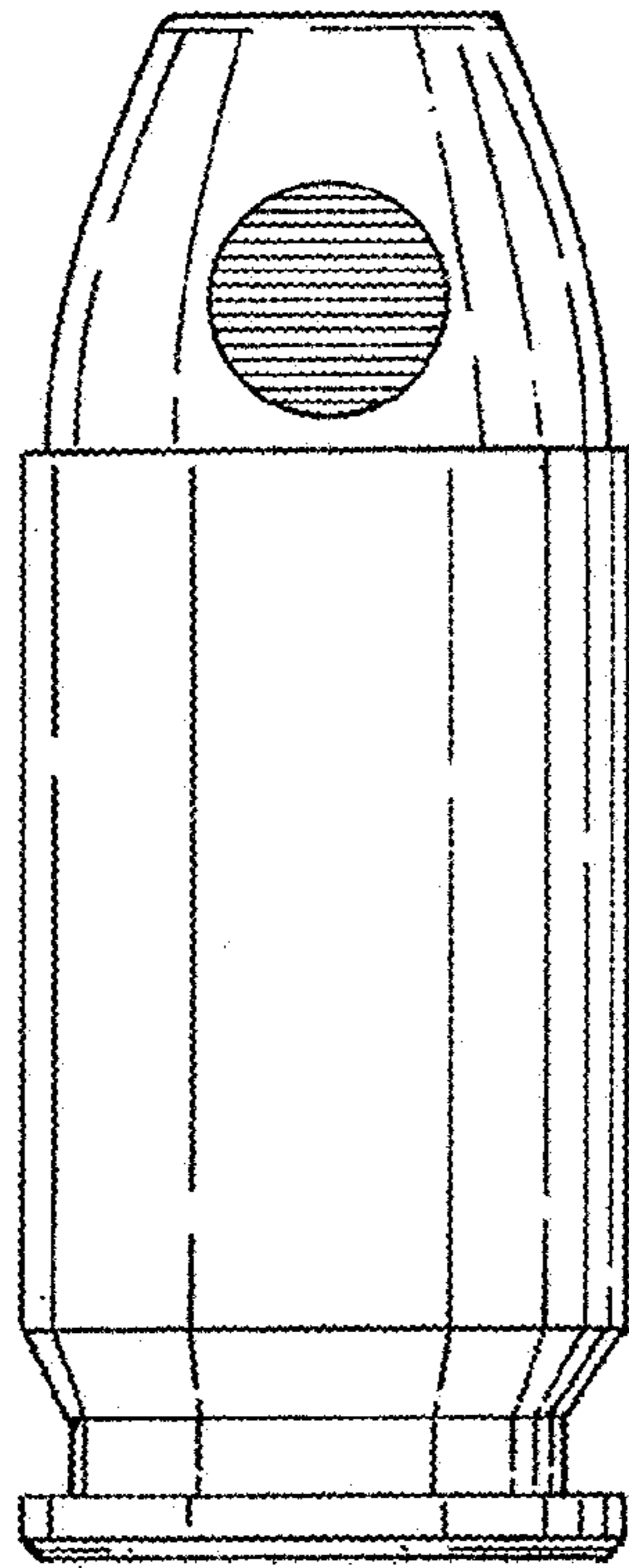

FIG. 10

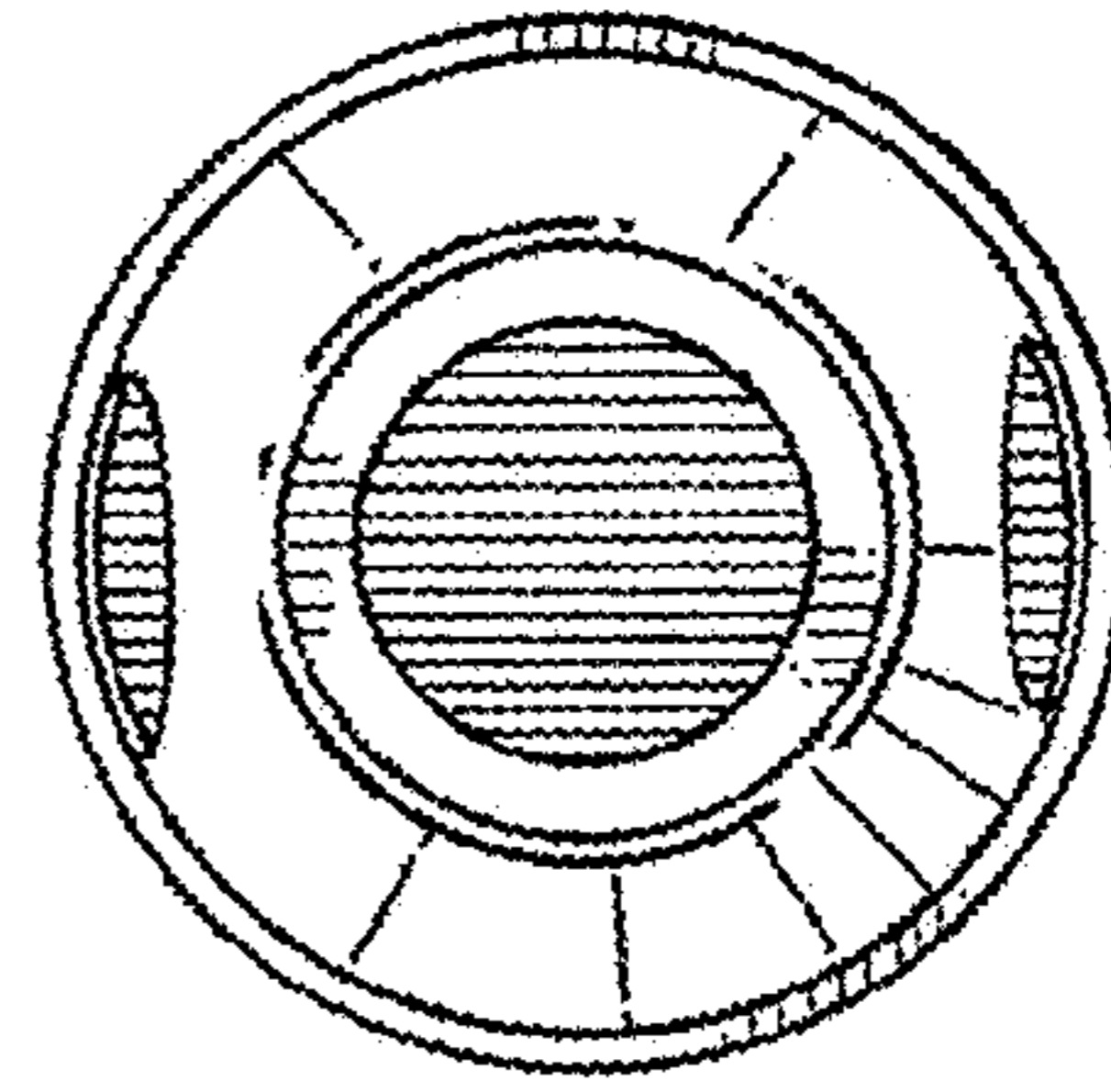

FIG. 9

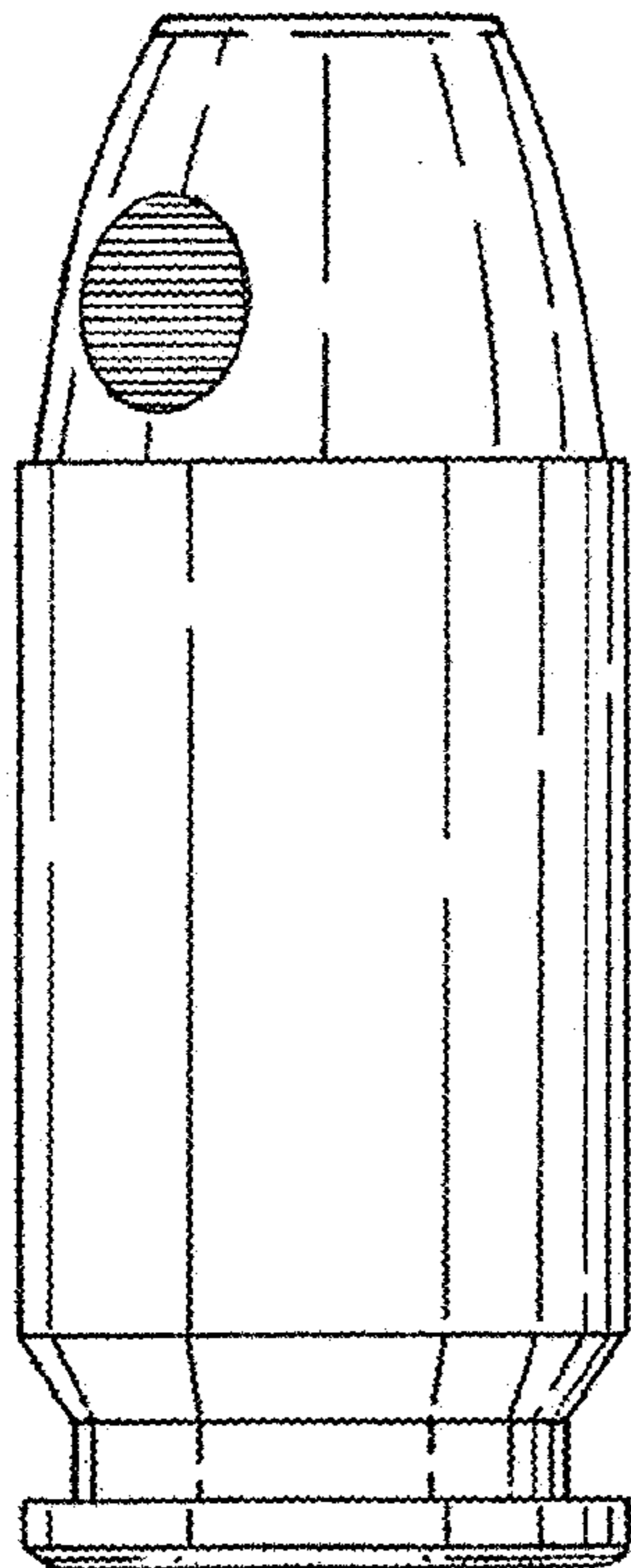

FIG. 11

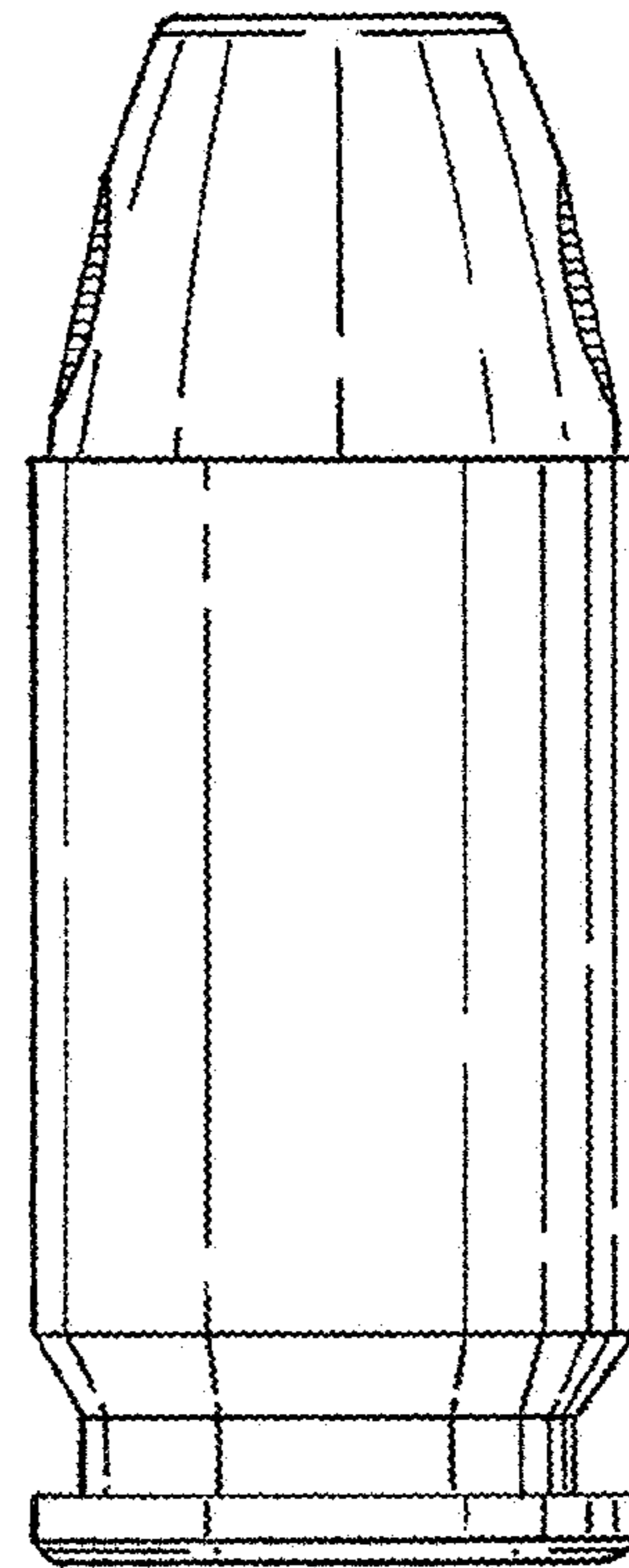

FIG. 12

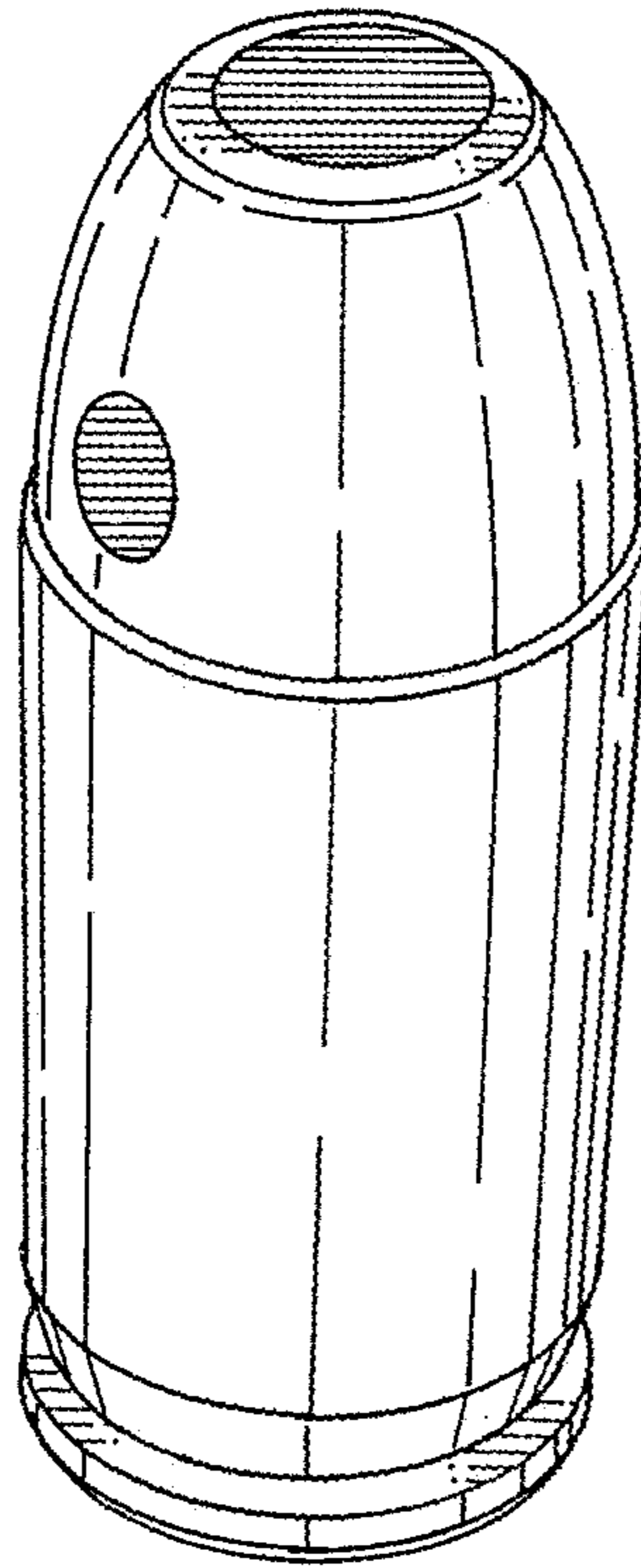

FIG. 13

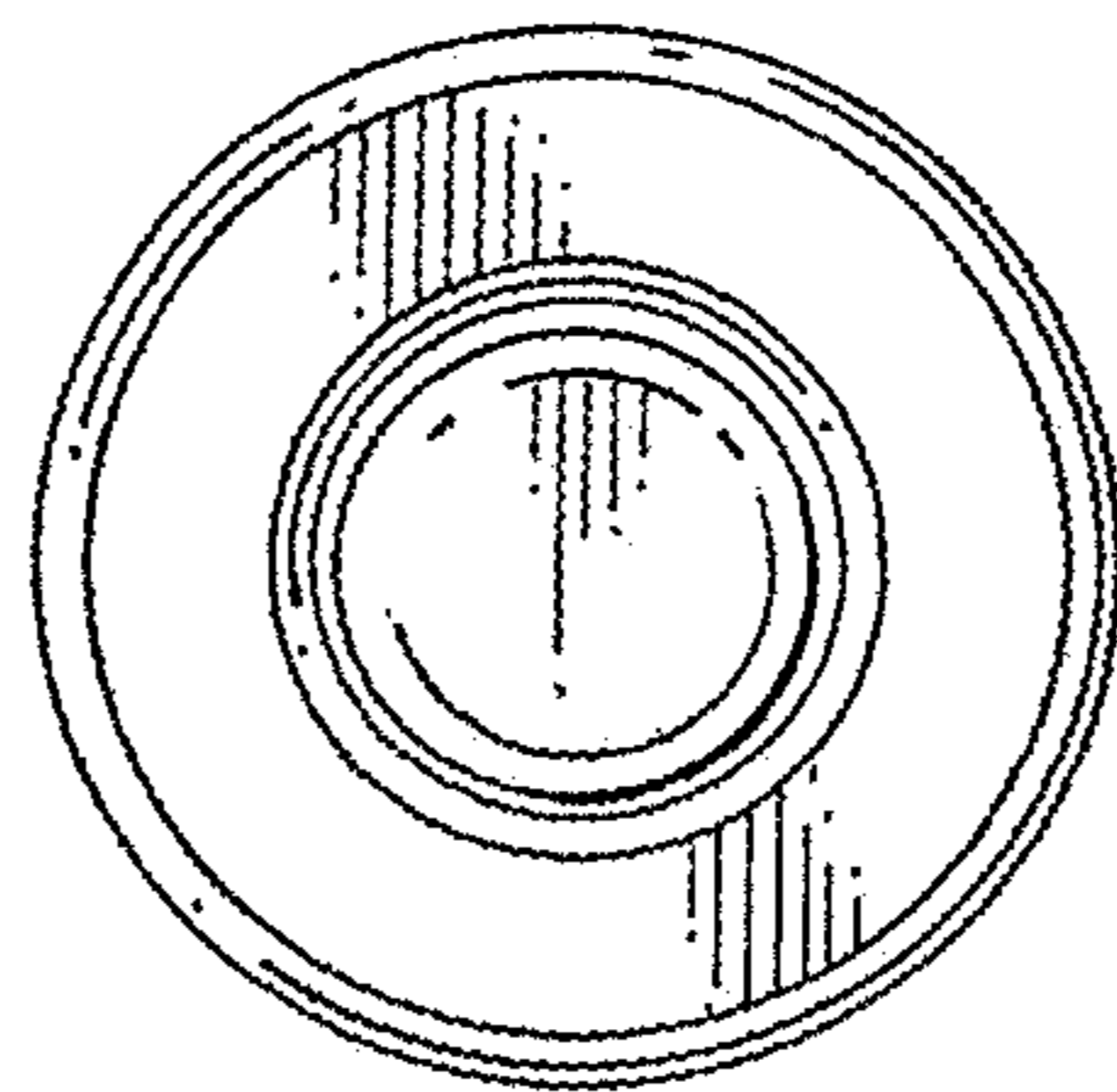

FIG. 14

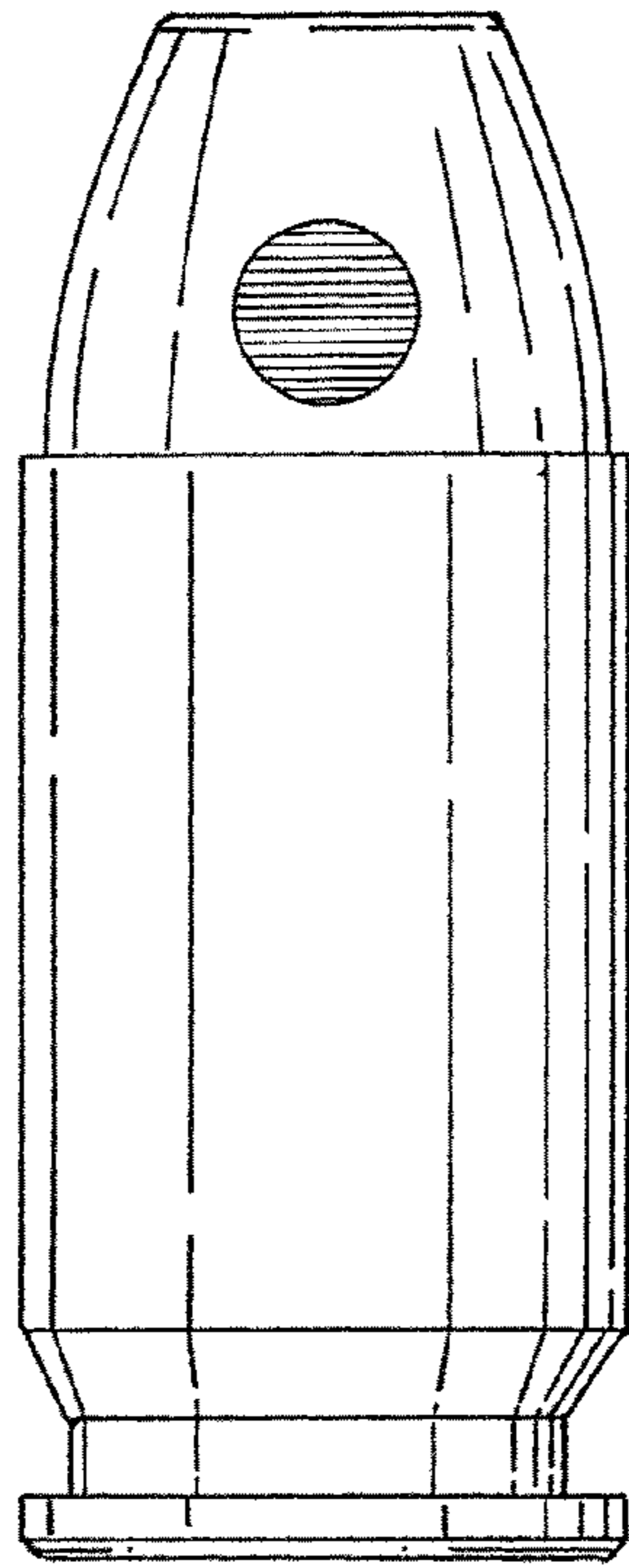

FIG. 16

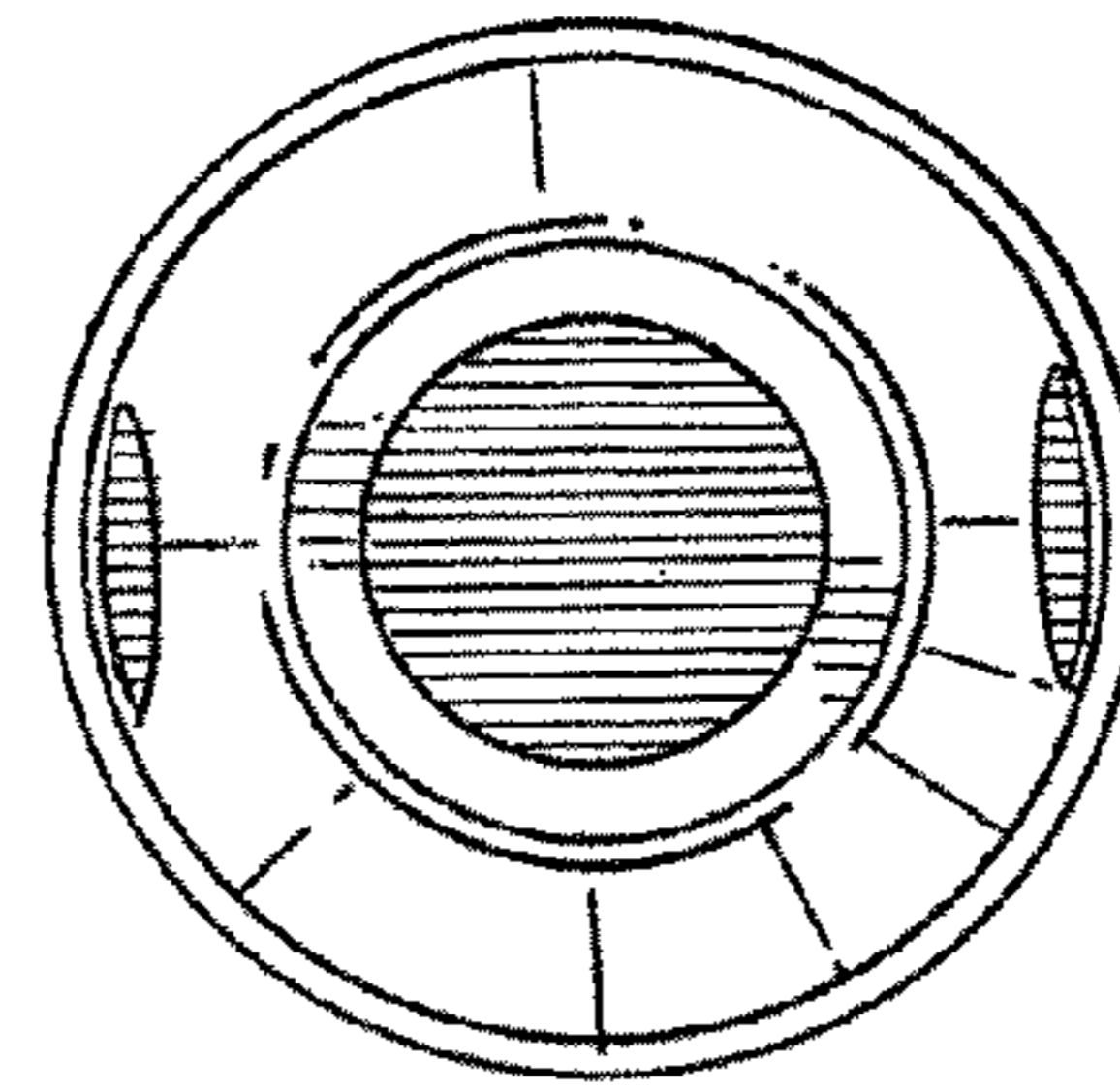

FIG. 15

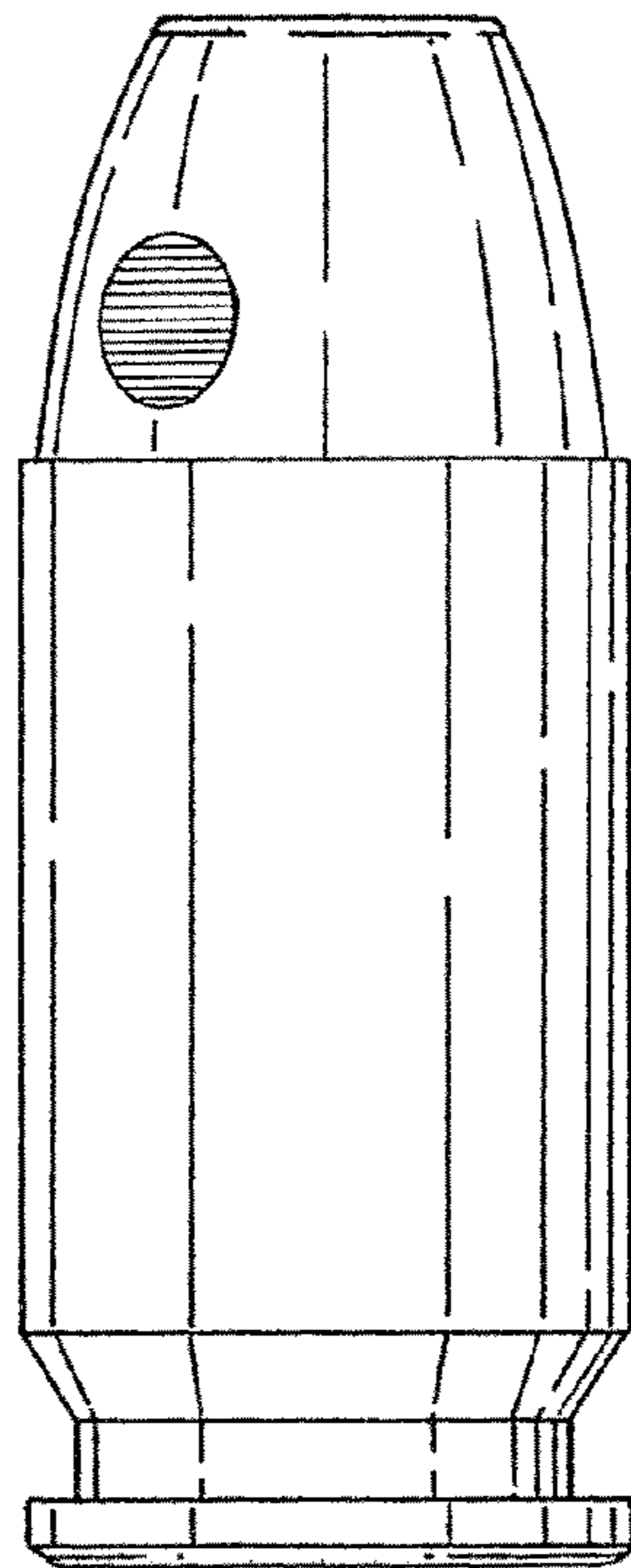

FIG. 17

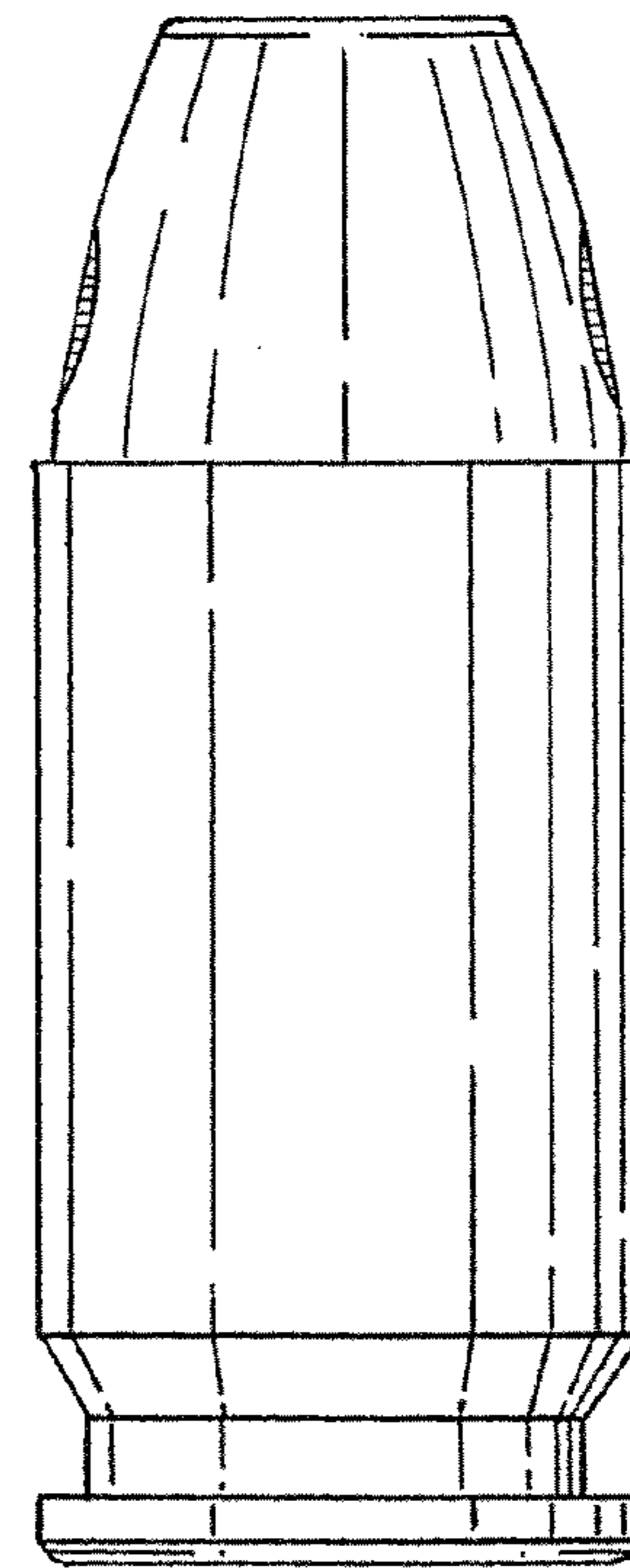

FIG. 18

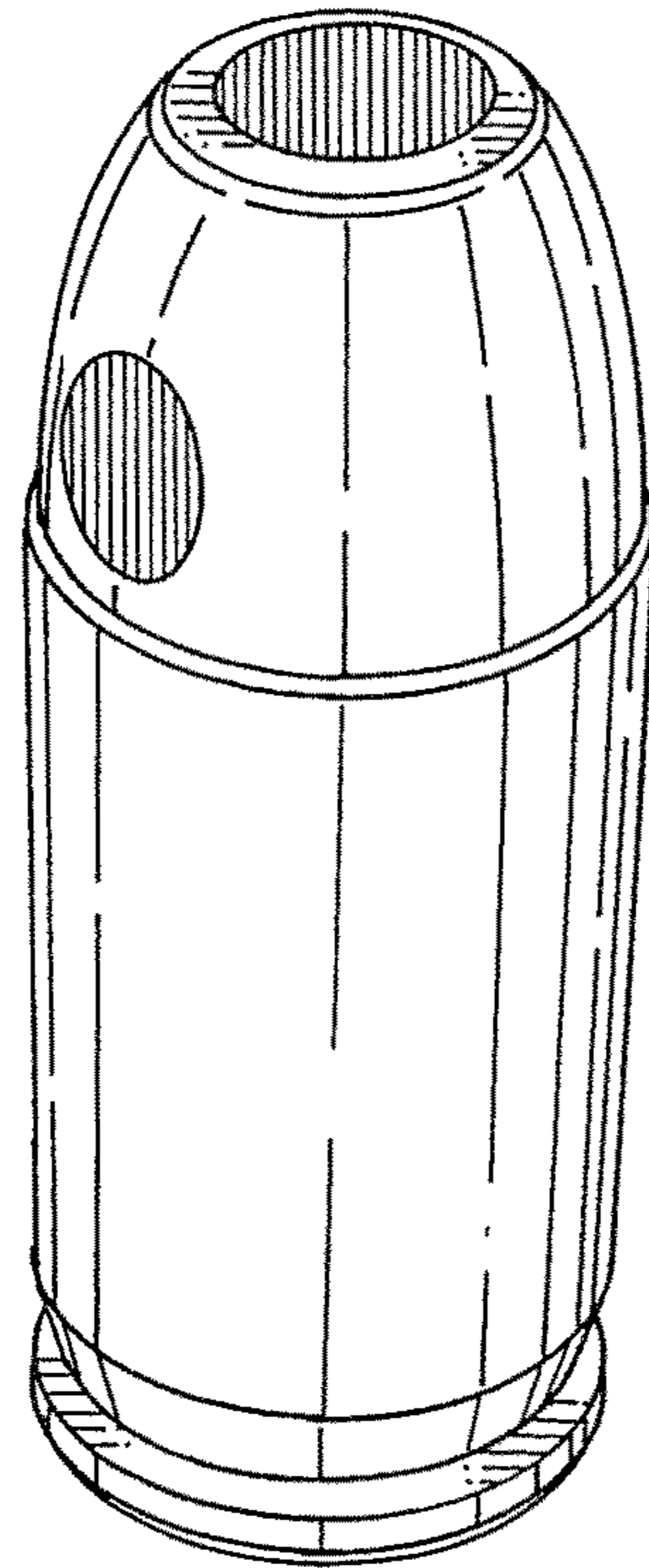

FIG. 19

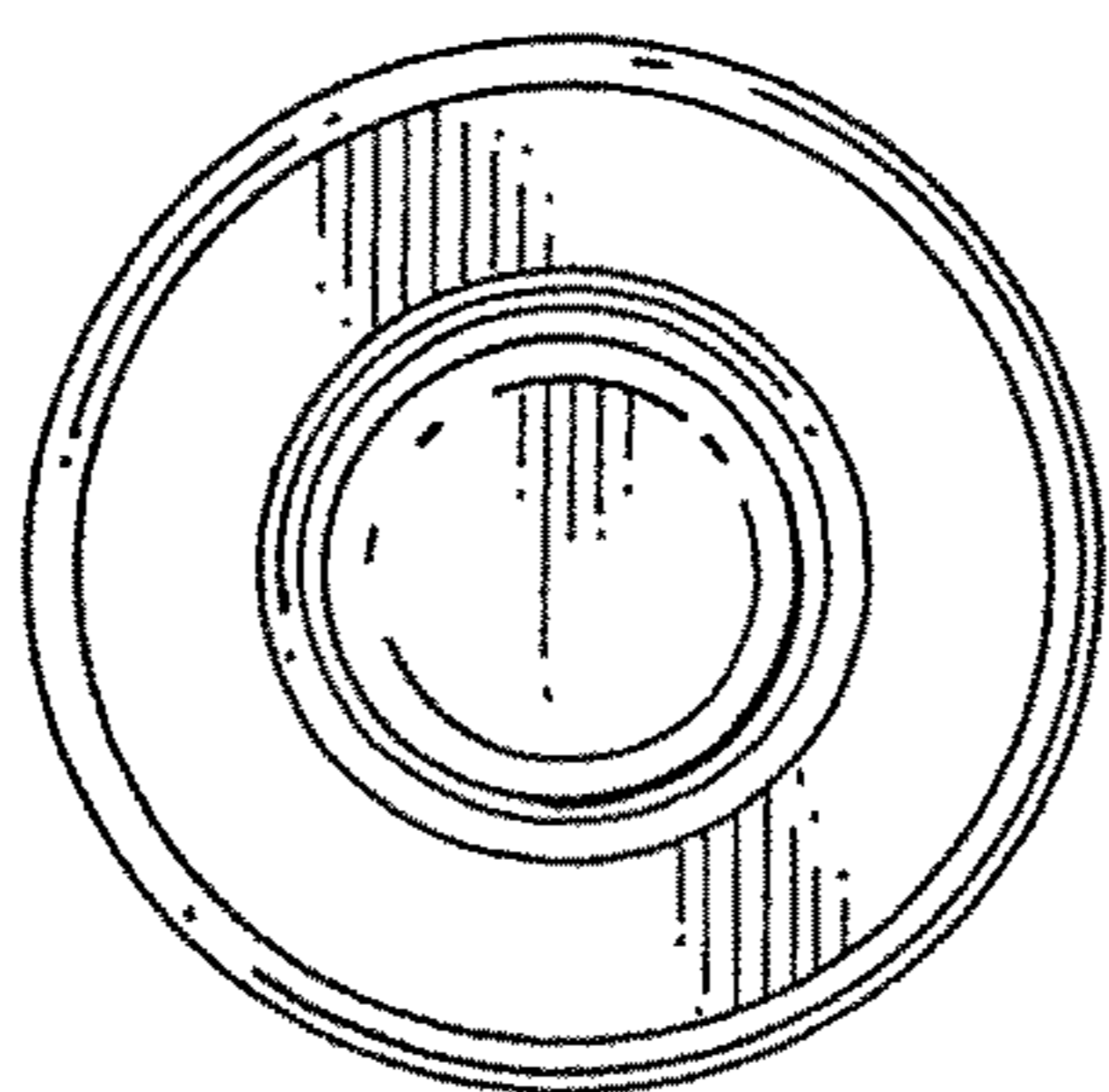

FIG. 20

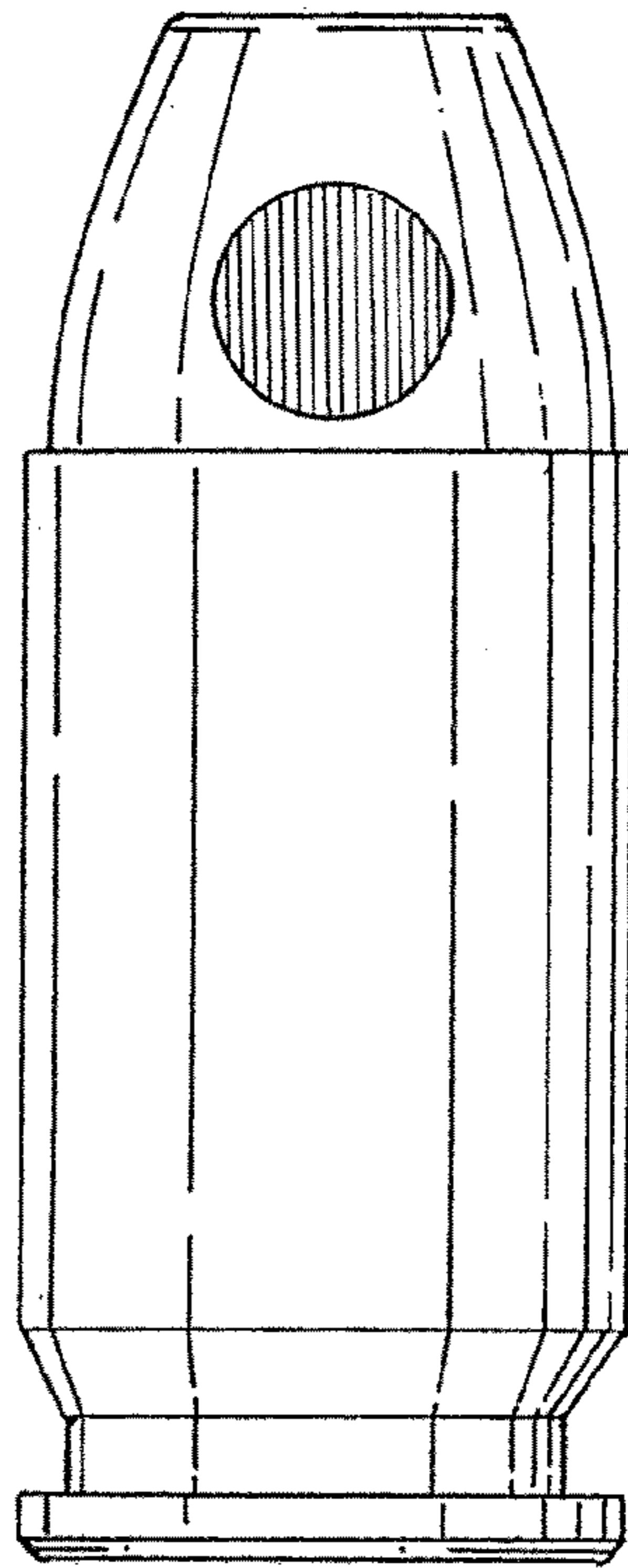

FIG. 22

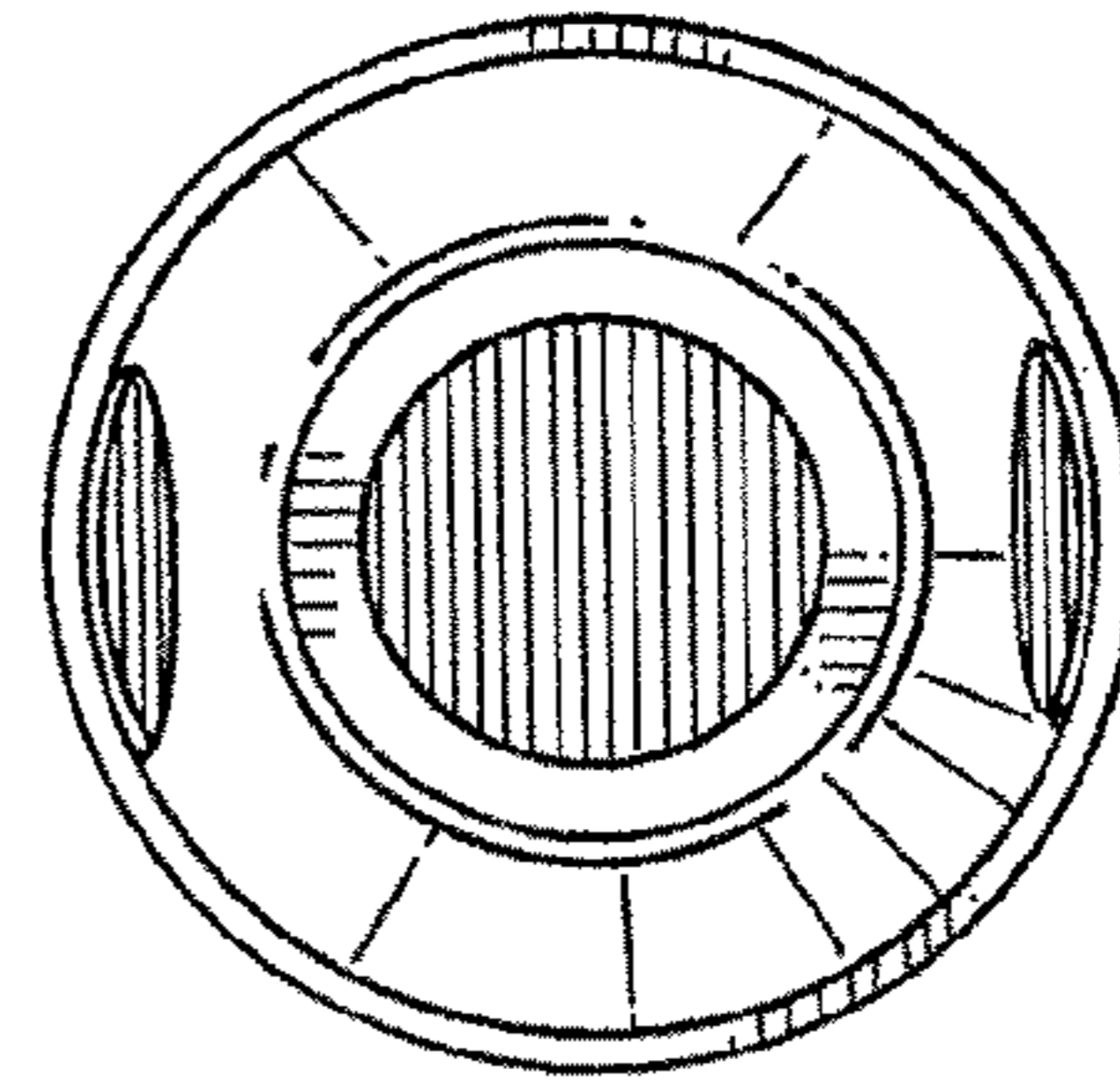

FIG. 21

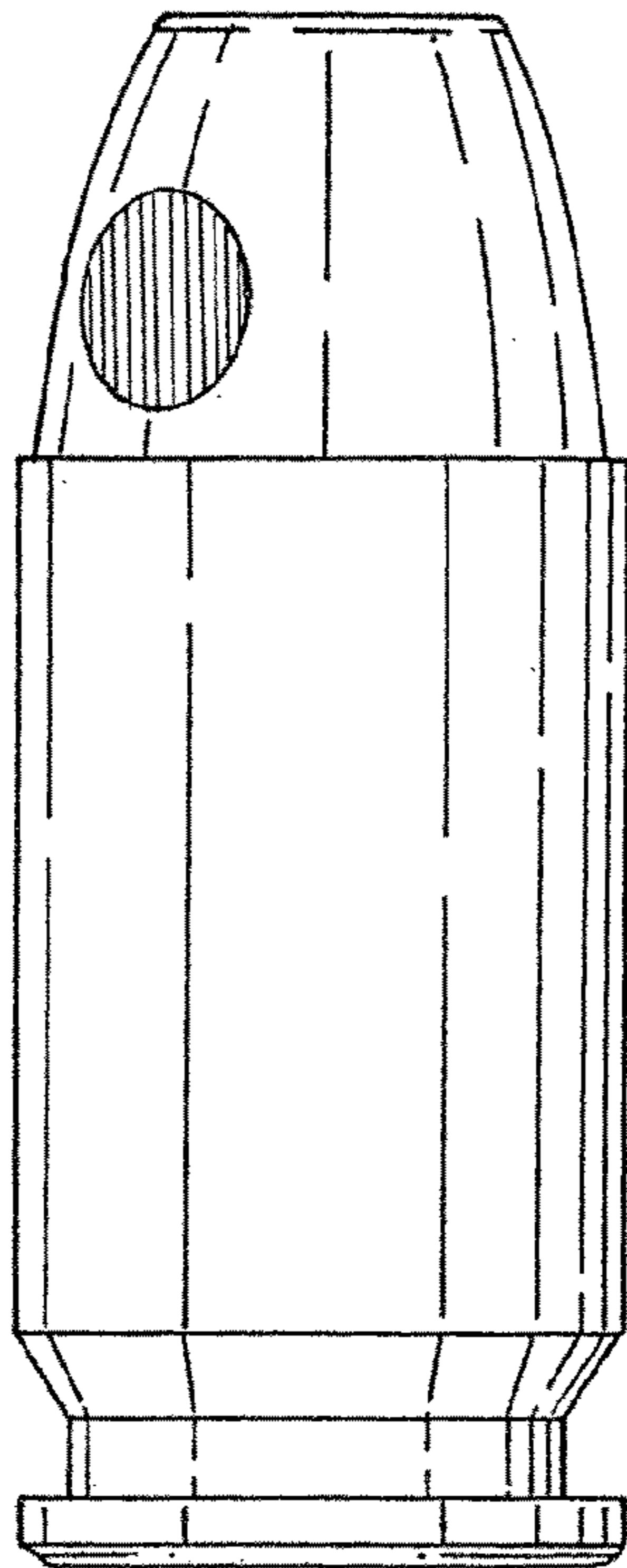

FIG. 23

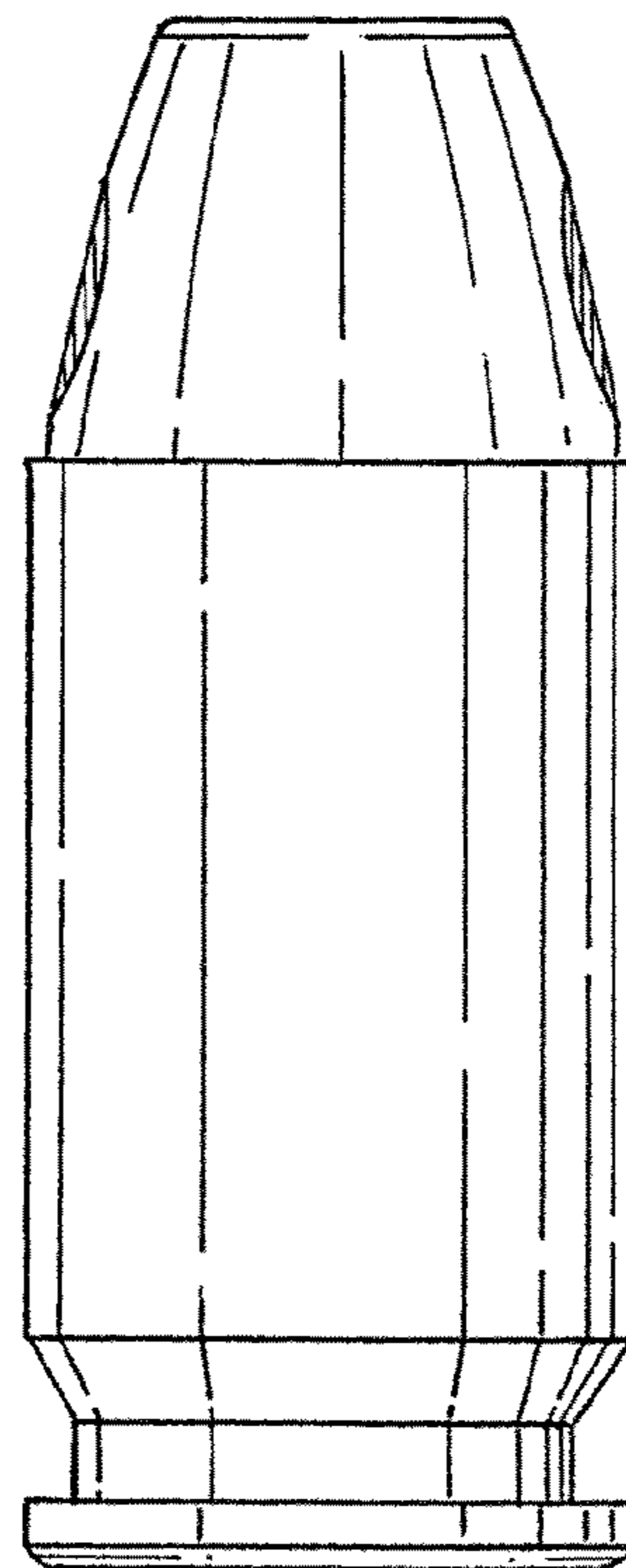

FIG. 24