



US00D707680S

(12) **United States Design Patent**
Akana et al.

(10) **Patent No.:** **US D707,680 S**
(45) **Date of Patent:** **** Jun. 24, 2014**

(54) **ADAPTER**

(71) Applicant: **Apple Inc.**, Cupertino, CA (US)
(72) Inventors: **Jody Akana**, San Francisco, CA (US);
Bartley K. Andre, Palo Alto, CA (US);
Jeremy Bataillou, San Francisco, CA
(US); **Daniel J. Coster**, San Francisco,
CA (US); **Daniele De Iuliis**, San
Francisco, CA (US); **M. Evans Hankey**,
San Francisco, CA (US); **Julian Hoenig**,
San Francisco, CA (US); **Richard P.**
Howarth, San Francisco, CA (US);
Jonathan P. Ive, San Francisco, CA
(US); **Duncan Robert Kerr**, San
Francisco, CA (US); **Shin Nishibori**,
Kailua, HI (US); **Matthew Dean**
Rohrbach, San Francisco, CA (US);
Peter Russell-Clarke, San Francisco,
CA (US); **Christopher J. Stringer**,
Woodside, CA (US); **Eugene Antony**
Whang, San Francisco, CA (US); **Rico**
Zörkendörfer, San Francisco, CA (US)

(73) Assignee: **Apple Inc.**, Cupertino, CA (US)

(**) Term: **14 Years**

(21) Appl. No.: **29/456,392**

(22) Filed: **May 30, 2013**

Related U.S. Application Data

(63) Continuation of application No. 29/431,556, filed on
Sep. 7, 2012, now Pat. No. Des. 684,976.

(51) **LOC (10) Cl.** **14-02**

(52) **U.S. Cl.**
USPC **D14/433**

(58) **Field of Classification Search**

USPC D14/356–358, 383–385, 420, 426, 427,
D14/432–439, 447, 453, 454, 217, 253,
D14/299; D13/107, 108, 133, 146, 147,
D13/152, 154, 156, 158, 162, 162.1, 168,
D13/173, 177; 439/131, 172–174, 373, 378;
361/679.08, 679.56, 679.21, 679.4

See application file for complete search history.

(56) **References Cited**

U.S. PATENT DOCUMENTS

D304,028 S 10/1989 Matsuzaki
5,179,501 A 1/1993 Ocken et al.

(Continued)

FOREIGN PATENT DOCUMENTS

WO WO 2006/074348 A1 7/2006
WO Wo 2011/150403 A1 12/2011

(Continued)

OTHER PUBLICATIONS

Co-Pending U.S. Appl. No. 29/441,757, filed Jan., 9. 2013 (Not
Published).

(Continued)

Primary Examiner — Austin Murphy

(74) *Attorney, Agent, or Firm* — Sterne, Kessler, Goldstein
& Fox P.L.L.C.

(57) **CLAIM**

The ornamental design for an adapter, as shown and
described.

DESCRIPTION

FIG. 1 is a top front perspective view of an adapter showing
our new design;
FIG. 2 is a bottom rear perspective view thereof;
FIG. 3 is a front view thereof, the rear view being a mirror
image thereof;
FIG. 4 is a side view thereof, the other side view being a
mirror image thereof;
FIG. 5 is a top view thereof; and,
FIG. 6 is a bottom view thereof.
The shade lines in the Figures show contour and not surface
ornamentation.

1 Claim, 4 Drawing Sheets

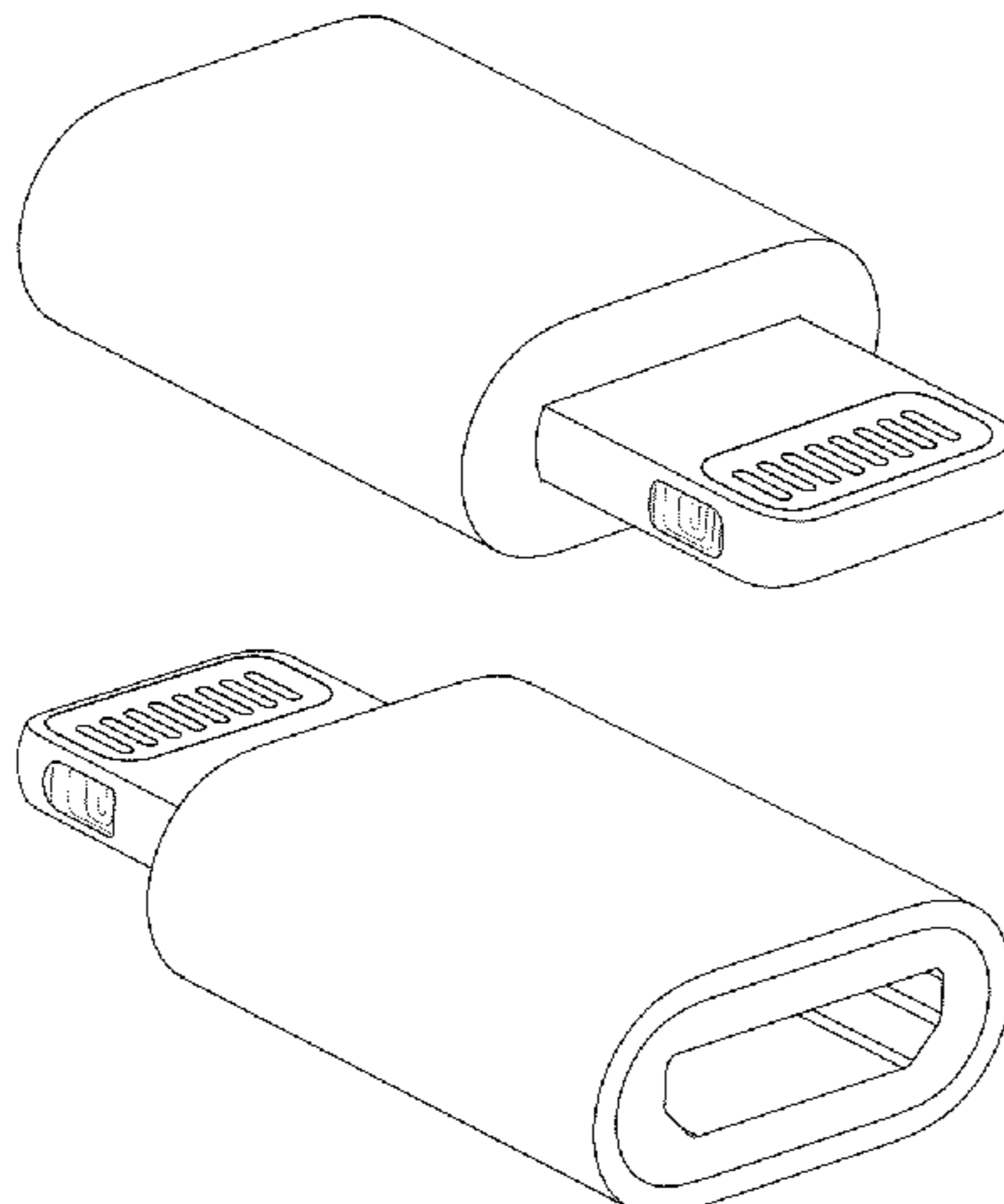

(56)

References Cited

U.S. PATENT DOCUMENTS

D369,157 S 4/1996 Ohmori et al.
 5,568,006 A 10/1996 Luff et al.
 D399,047 S 10/1998 Yoshida et al.
 6,137,710 A 10/2000 Iwasaki et al.
 D446,499 S 8/2001 Andre et al.
 D452,245 S 12/2001 Wallace et al.
 D452,246 S 12/2001 Wallace et al.
 D454,110 S 3/2002 Andre et al.
 6,483,038 B2 11/2002 Lee et al.
 D487,747 S 3/2004 Yu et al.
 D522,463 S * 6/2006 Novotney et al. D13/154
 D525,977 S 8/2006 Yao
 7,094,089 B2 8/2006 Andre et al.
 D534,184 S 12/2006 Leija et al.
 D537,036 S * 2/2007 Chen D14/433
 D537,780 S 3/2007 Suckle
 D552,099 S 10/2007 Nishizawa et al.
 D552,604 S * 10/2007 Andre et al. D14/242
 7,354,312 B2 4/2008 Chuang
 D574,365 S * 8/2008 Andre et al. D14/217
 D574,834 S 8/2008 Chen
 D577,990 S 10/2008 Andre et al.
 D578,991 S * 10/2008 Donovan et al. D14/155
 D588,545 S * 3/2009 Andre et al. D13/154
 D594,418 S 6/2009 Fujino et al.
 D599,800 S * 9/2009 Klein et al. D14/433
 D600,652 S * 9/2009 Hong et al. D13/154
 D604,725 S * 11/2009 Chen D14/240
 D605,650 S * 12/2009 Ribeiro D14/433
 D607,886 S 1/2010 Bolotin et al.
 D618,226 S * 6/2010 Tong et al. D14/240
 D621,785 S 8/2010 Nickol
 D624,548 S * 9/2010 Yamamoto D14/433
 D628,151 S * 11/2010 Wegener et al. D13/108
 D628,537 S * 12/2010 Nagata et al. D13/147
 D631,883 S * 2/2011 Maier D14/435.1
 D634,326 S 3/2011 Gehrke
 D635,142 S * 3/2011 Borislow D14/435.1
 D636,337 S * 4/2011 Smith et al. D13/147
 D643,040 S 8/2011 Sedio et al.
 D648,726 S * 11/2011 Behar et al. D14/435.1
 D655,296 S 3/2012 Andre et al.
 D656,147 S 3/2012 Schlossstein
 D658,665 S 5/2012 Akana et al.
 D659,150 S 5/2012 Andre
 D665,734 S 8/2012 Fitch et al.
 D665,754 S * 8/2012 Cobbett et al. D13/147
 D672,780 S 12/2012 Chen et al.
 D680,076 S * 4/2013 McManigal D13/147
 D680,539 S * 4/2013 Kim D14/433
 D682,835 S * 5/2013 Daniel D14/433
 D683,703 S * 6/2013 Akana et al. D13/147
 D684,539 S 6/2013 Akana et al.
 D684,976 S * 6/2013 Akana et al. D14/433
 8,454,388 B2 * 6/2013 Song 439/607.36
 2002/0170972 A1 11/2002 Kim
 2003/0225954 A1 * 12/2003 Wu 710/305
 2005/0109841 A1 * 5/2005 Ryan et al. 235/380
 2005/0202727 A1 * 9/2005 Andre et al. 439/660
 2007/0123106 A1 * 5/2007 Zhang 439/610
 2007/0229025 A1 * 10/2007 Tsai et al. 320/111
 2007/0293079 A1 * 12/2007 Chao et al. 439/352
 2011/0199729 A1 * 8/2011 Hsieh 361/679.33
 2012/0252256 A1 10/2012 Zhu et al.
 2013/0084760 A1 4/2013 Siahaan et al.
 2013/0175326 A1 7/2013 Jol et al.

FOREIGN PATENT DOCUMENTS

WO WO 2011/160138 A2 12/2011
 WO WO 2011/163256 A1 12/2011
 WO WO 2011/163260 A1 12/2011
 WO WO 2012/103383 A2 8/2012
 WO WO 2013/0817041 6/2013

OTHER PUBLICATIONS

Co-pending U.S. Appl. No. 29/455,174, filed May 17, 2013 (Not Published).
 Co-pending U.S. Appl. No. 29/455,173, filed May 17, 2013 (Not Published).
 Co-pending U.S. Appl. No. 29/456,487, filed May 31, 2013 (Not Published).
 Co-pending U.S. Appl. No. 29/456,394, filed May 30, 2013 (Not Published).
 U.S. Appl. No. 29/424,270, filed Jun. 10, 2012 (Not Published).
 U.S. Appl. No. 29/431,841, filed Sep. 11, 2012 (Not Published).
 U.S. Appl. No. 29/431,876, filed Sep. 11, 2012 (Not Published).
 U.S. Appl. No. 29/432,034, filed Sep. 12, 2012 (Not Published).
 U.S. Appl. No. 13/607,366, filed Sep. 7, 2012 (Not Published).
 U.S. Appl. No. 13/607,404, filed Sep. 7, 2012 (Not Published).
 U.S. Appl. No. 13/607,426, filed Sep. 7, 2012 (Not Published).
 U.S. Appl. No. 13/607,430, filed Sep. 7, 2012 (Not Published).
 U.S. Appl. No. 13/607,443, filed Sep. 7, 2012 (Not Published).
 U.S. Appl. No. 13/607,446, filed Sep. 7, 2012 (Not Published).
 U.S. Appl. No. 13/607,454, filed Sep. 7, 2012 (Not Published).
 U.S. Appl. No. 13/607,462, filed Sep. 7, 2012 (Not Published).
 U.S. Appl. No. 13/607,473, filed Sep. 7, 2012 (Not Published).
 U.S. Appl. No. 13/607,478, filed Sep. 7, 2012 (Not Published).
 U.S. Appl. No. 13/607,497, filed Sep. 7, 2012 (Not Published).
 U.S. Appl. No. 13/607,502, filed Sep. 7, 2012 (Not Published).
 U.S. Appl. No. 13/607,519, filed Sep. 7, 2012 (Not Published).
 U.S. Appl. No. 13/607,528, filed Sep. 7, 2012 (Not Published).
 U.S. Appl. No. 13/607,550, filed Sep. 7, 2012 (Not Published).
 U.S. Appl. No. 13/607,553, filed Sep. 7, 2012 (Not Published).
 U.S. Appl. No. 13/607,554, filed Sep. 7, 2012 (Not Published).
 U.S. Appl. No. 13/607,563, filed Sep. 7, 2012 (Not Published).
 U.S. Appl. No. 13/607,566, filed Sep. 7, 2012 (Not Published).
 U.S. Appl. No. 13/607,598, filed Sep. 7, 2012 (Not Published).
 U.S. Appl. No. 13/607,600, filed Sep. 7, 2012 (Not Published).
 U.S. Appl. No. 13/610,326, filed Sep. 11, 2012 (Not Published).
 U.S. Appl. No. 13/610,631, filed Sep. 11, 2012 (Not Published).
 U.S. Appl. No. 13/610,750, filed Sep. 11, 2012 (Not Published).
 U.S. Appl. No. 13/610,832, filed Sep. 11, 2012 (Not Published).
 U.S. Appl. No. 61/668,074, filed Jul. 5, 2012 (Not Published).
 U.S. Appl. No. 61/693,228, filed Aug. 24, 2012 (Not Published).
 U.S. Appl. No. 61/693,232, filed Aug. 24, 2012 (Not Published).
 U.S. Appl. No. 61/693,496, filed Sep. 7, 2012 (Not Published).
 U.S. Appl. No. 61/698,538, filed Sep. 7, 2012 (Not Published).
 U.S. Appl. No. 61/699,818, filed Sep. 11, 2012 (Not Published).
 U.S. Appl. No. 61/699,838, filed Sep. 11, 2012 (Not Published).
 International Patent Application No. PCT/CN2012/081245, filed Sep. 11, 2012 (Not Published)
 International Patent Application No. PCT/CN2012/081257, filed Sep. 11, 2012 (Not Published)
 Co-Pending U.S. Appl. No. 29/449,244, filed Mar. 14, 2013 (Not Published).
 U.S. Appl. No. 29/441,757, filed Jan. 9, 2013 (Not Published).
 U.S. Appl. No. 29/445,174, filed May 17, 2013 (Not Published).
 U.S. Appl. No. 29/456,392, filed May 30, 2013 (Not Published).
 U.S. Appl. No. 29/456,487, filed May 31, 2013 (Not Published).
 U.S. Appl. No. 29/456,394, filed Jan. 9, 2013 (Not Published).

* cited by examiner

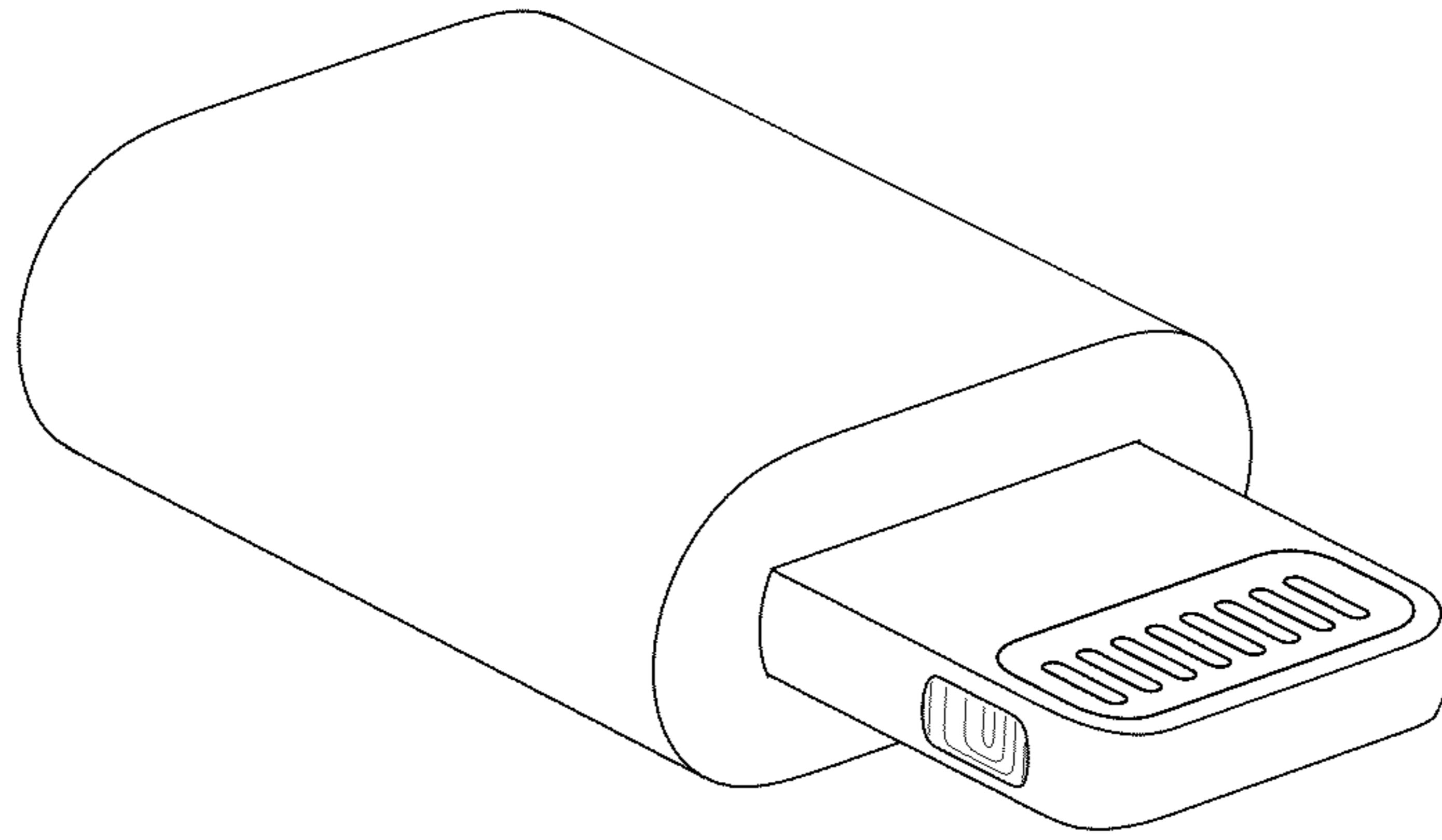

FIG. 1

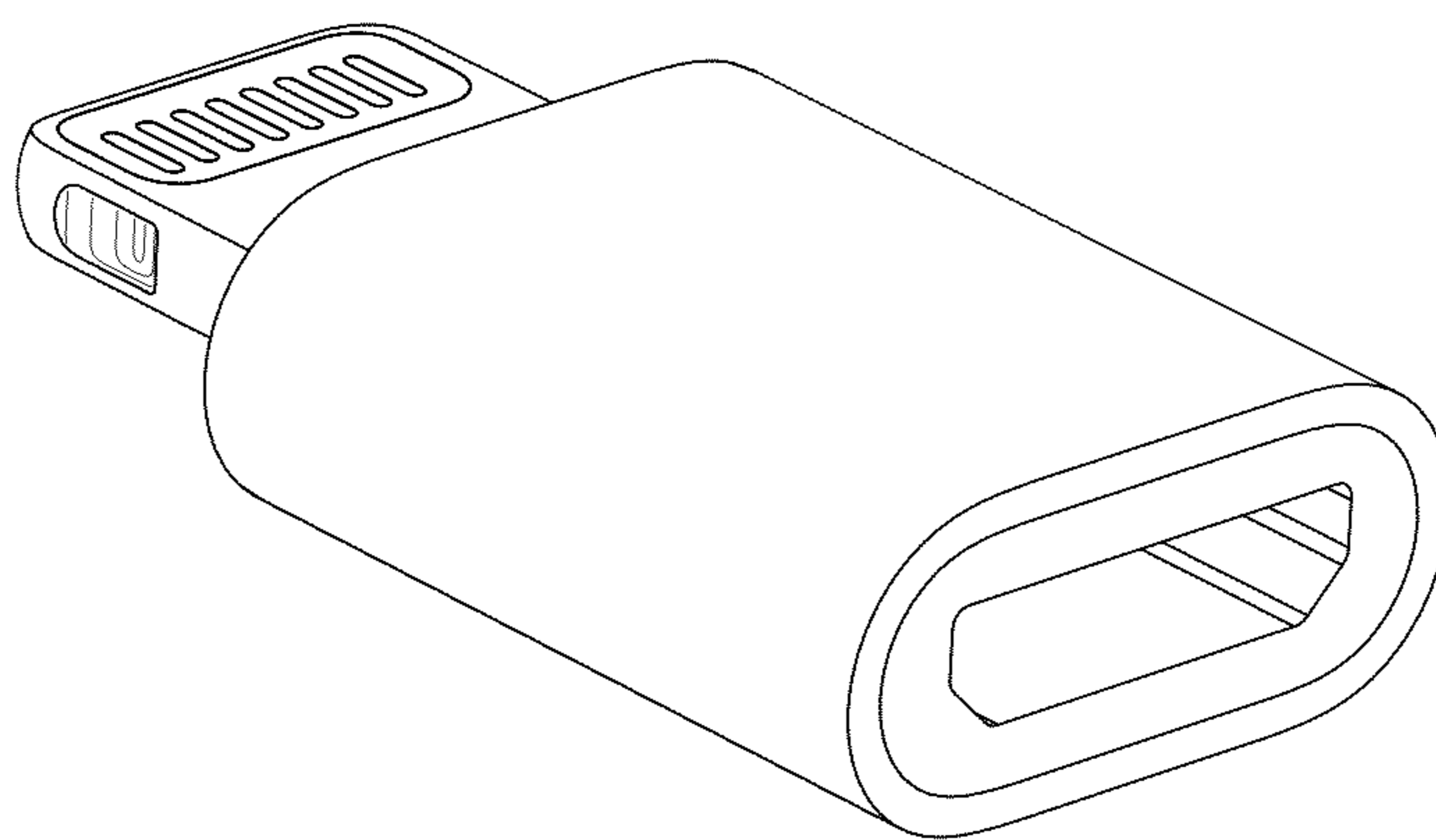

FIG. 2

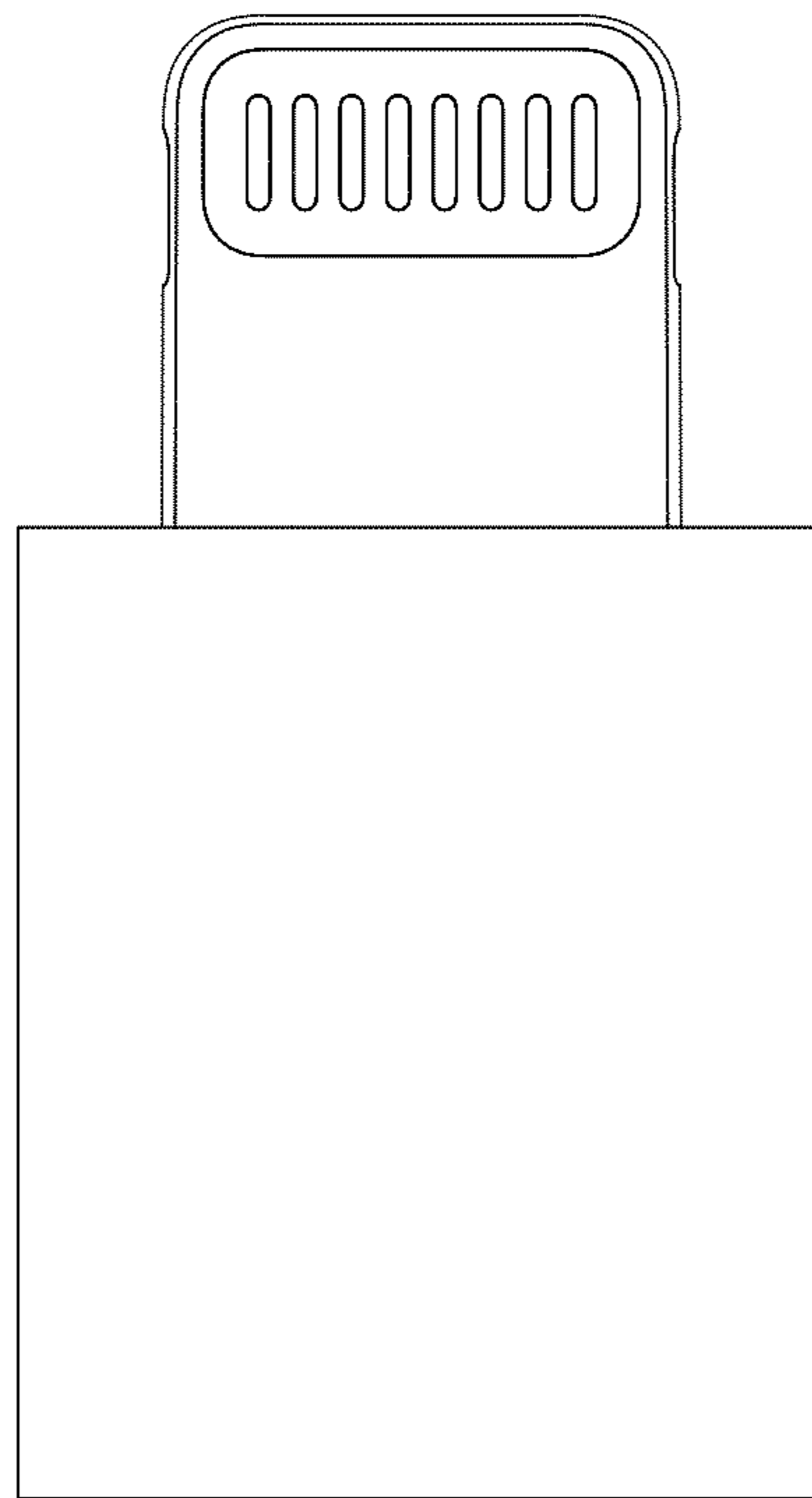

FIG. 3

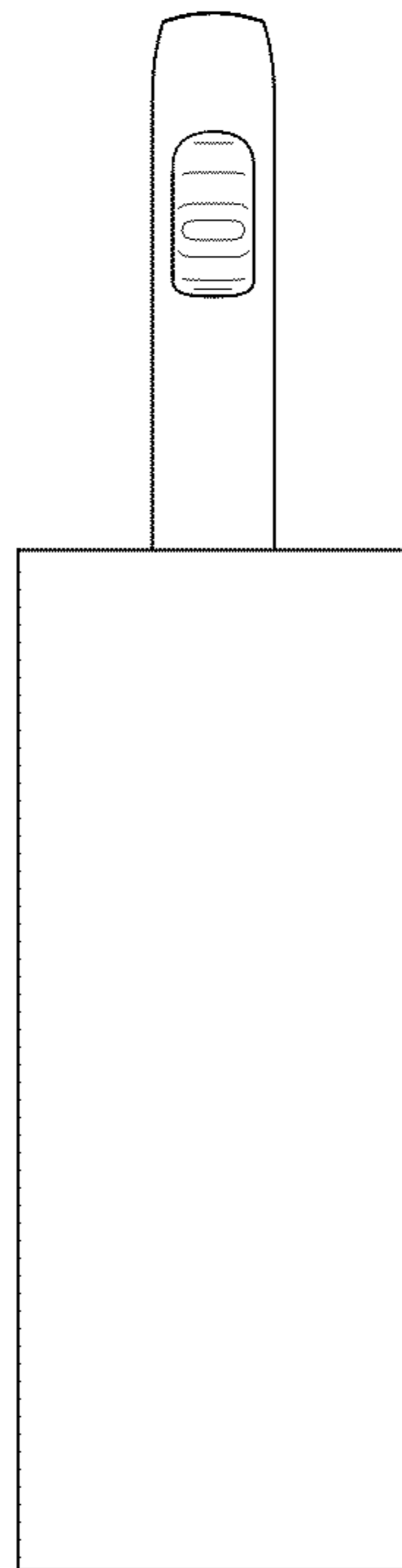

FIG. 4

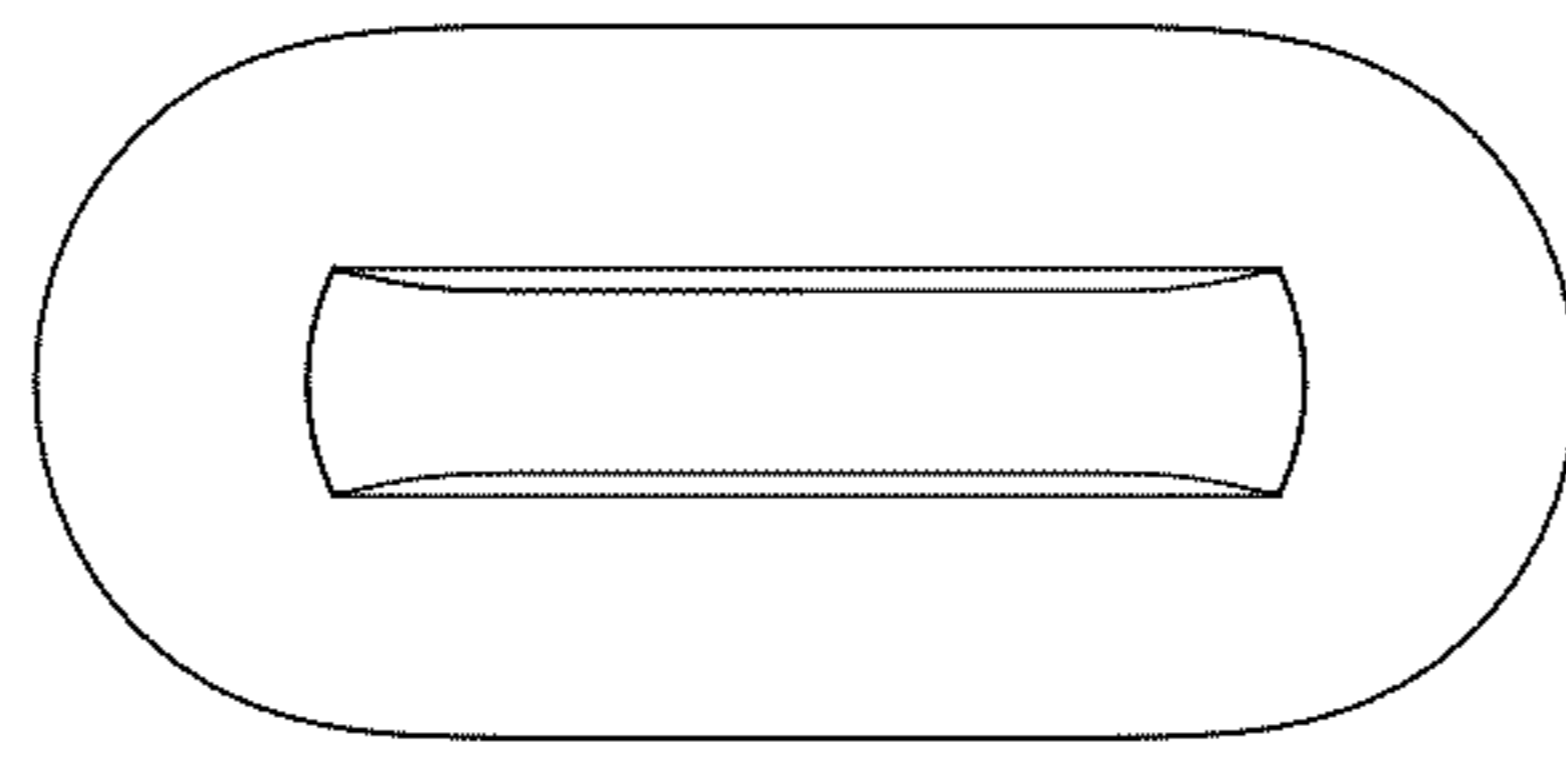

FIG. 5

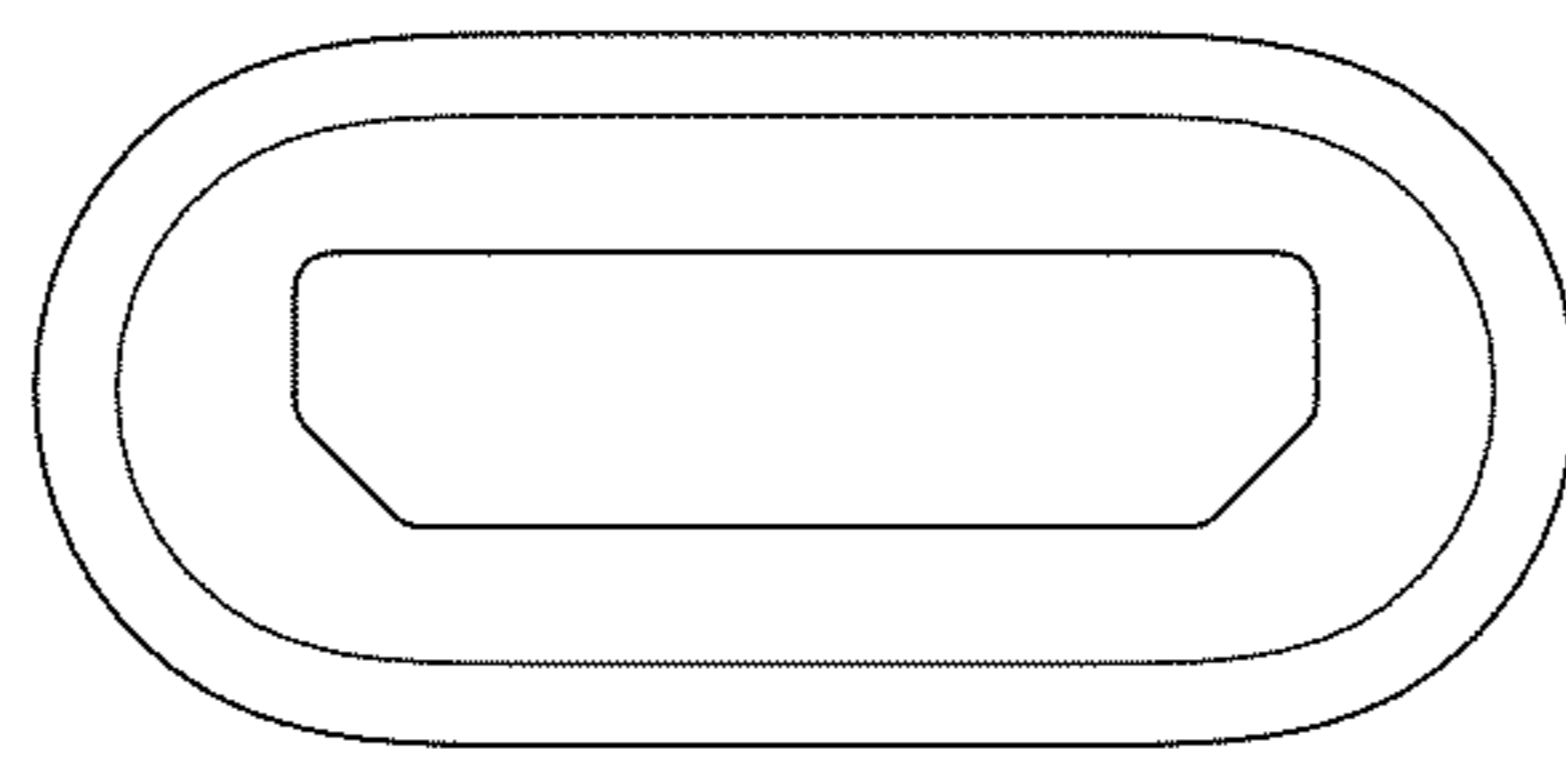

FIG. 6