

US00D707599S

(12) **United States Design Patent**  
**Pifer, III**

(10) **Patent No.:** **US D707,599 S**  
(45) **Date of Patent:** **\*\* Jun. 24, 2014**

(54) **DETACHABLE REAR WINDOW FOR AN OPEN DECK VEHICLE**

(71) Applicant: **Idea Creation Factory, LLC**,  
Alpharetta, GA (US)

(72) Inventor: **Gratton Olin Pifer, III**, Johns Creek,  
GA (US)

(73) Assignee: **Idea Creation Factory, LLC**,  
Alpharetta, GA (US)

(\*\*) Term: **14 Years**

(21) Appl. No.: **29/460,980**

(22) Filed: **Jul. 17, 2013**

(51) **LOC (10) Cl.** ..... **12-08**

(52) **U.S. Cl.**  
USPC ..... **D12/183**

(58) **Field of Classification Search**  
USPC ..... D12/183, 400-401, 191, 182, 417, 181;  
150/166, 168; 160/DIG. 2, DIG. 3,  
160/370.21-370.23; 224/312; 296/84.1, 89,  
296/96, 97.1, 97.5-97.11, 146.1, 187.01,  
296/190.01; 49/502-504; 428/12  
See application file for complete search history.

(56) **References Cited**

**U.S. PATENT DOCUMENTS**

2,803,282 A \* 8/1957 Wilcox ..... 150/166  
4,862,943 A \* 9/1989 Shafia ..... 160/370.21  
5,035,460 A \* 7/1991 Huang ..... 296/95.1  
5,732,759 A \* 3/1998 Wang ..... 160/370.21

7,252,106 B2 \* 8/2007 Conforti ..... 135/117  
D600,755 S \* 9/2009 O'Brien ..... D20/42  
7,823,953 B2 \* 11/2010 Haas ..... 296/95.1  
D658,565 S \* 5/2012 Akmal ..... D12/401  
8,342,226 B2 \* 1/2013 Zheng ..... 160/370.21  
8,667,626 B2 \* 3/2014 Zheng ..... 5/99.1

\* cited by examiner

*Primary Examiner* — Katrina A Betton

(74) *Attorney, Agent, or Firm* — Howson & Howson LLP

(57) **CLAIM**

The ornamental design for a detachable rear window for open deck vehicle, as shown and described.

**DESCRIPTION**

FIG. 1 is a perspective view, as seen from a location to the left and rear, of a detachable rear window for open deck vehicle, showing my new design;  
FIG. 2 is a perspective view thereof, as seen from a location to the left and front;  
FIG. 3 is rear elevational view thereof;  
FIG. 4 is a bottom plan view thereof;  
FIG. 5 is top plan view thereof;  
FIG. 6 is a left side elevational view thereof; and,  
FIG. 7 is another perspective view thereof as seen from a location to the left and rear.  
The right side elevational view is a mirror image of the left side. The broken line illustration of an open deck vehicle in FIG. 7 constitutes environmental structure which is not part of the claimed design.

**1 Claim, 7 Drawing Sheets**

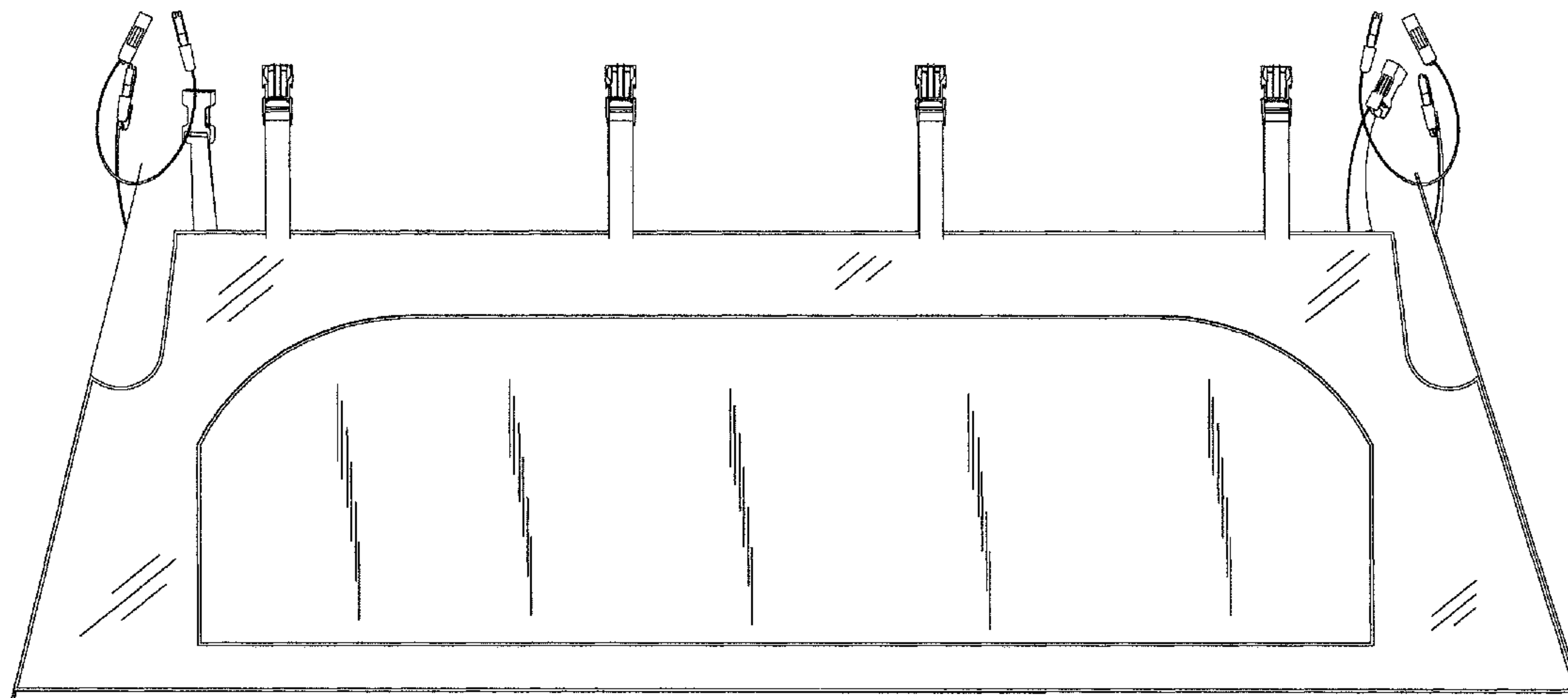

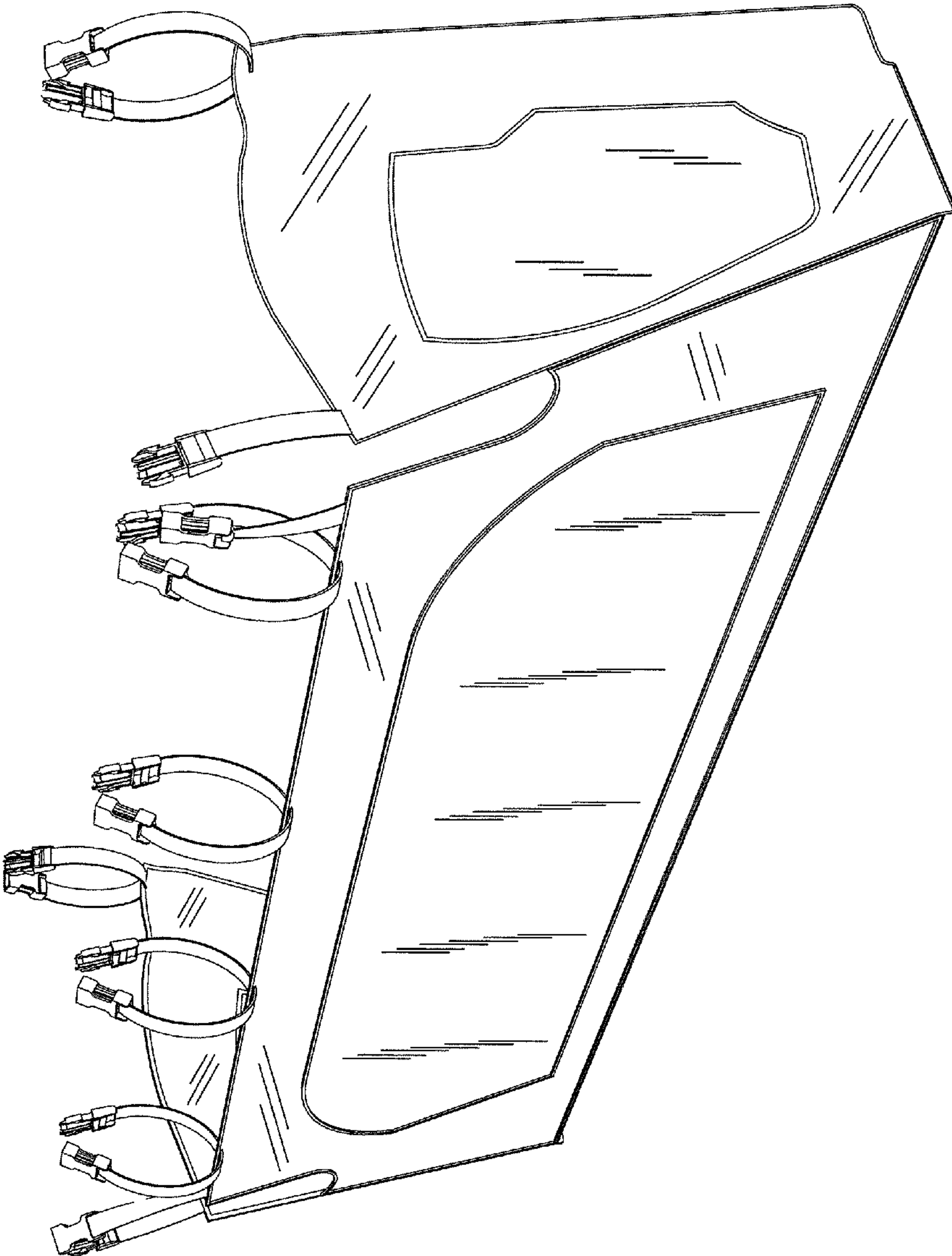

FIG. 1

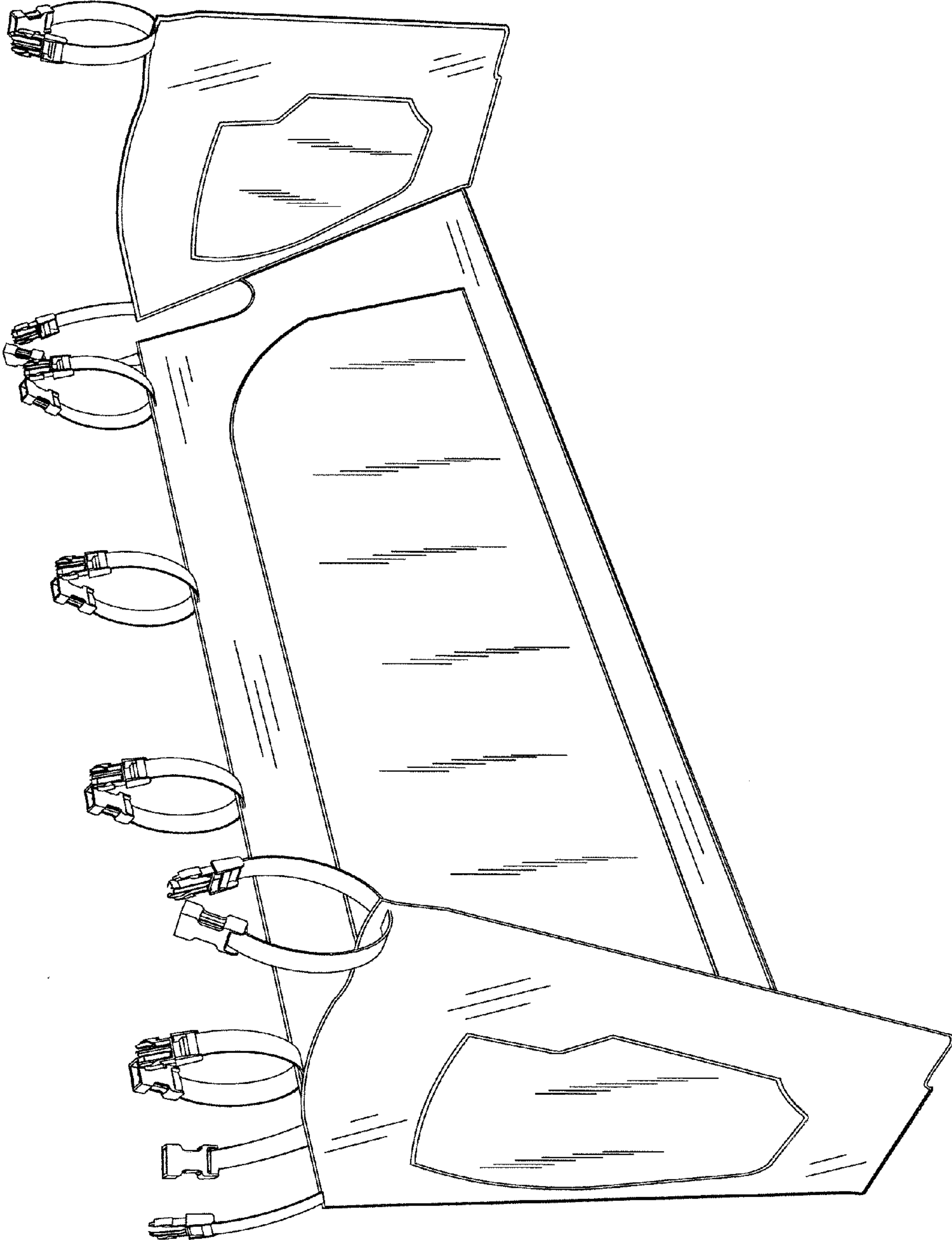

FIG. 2

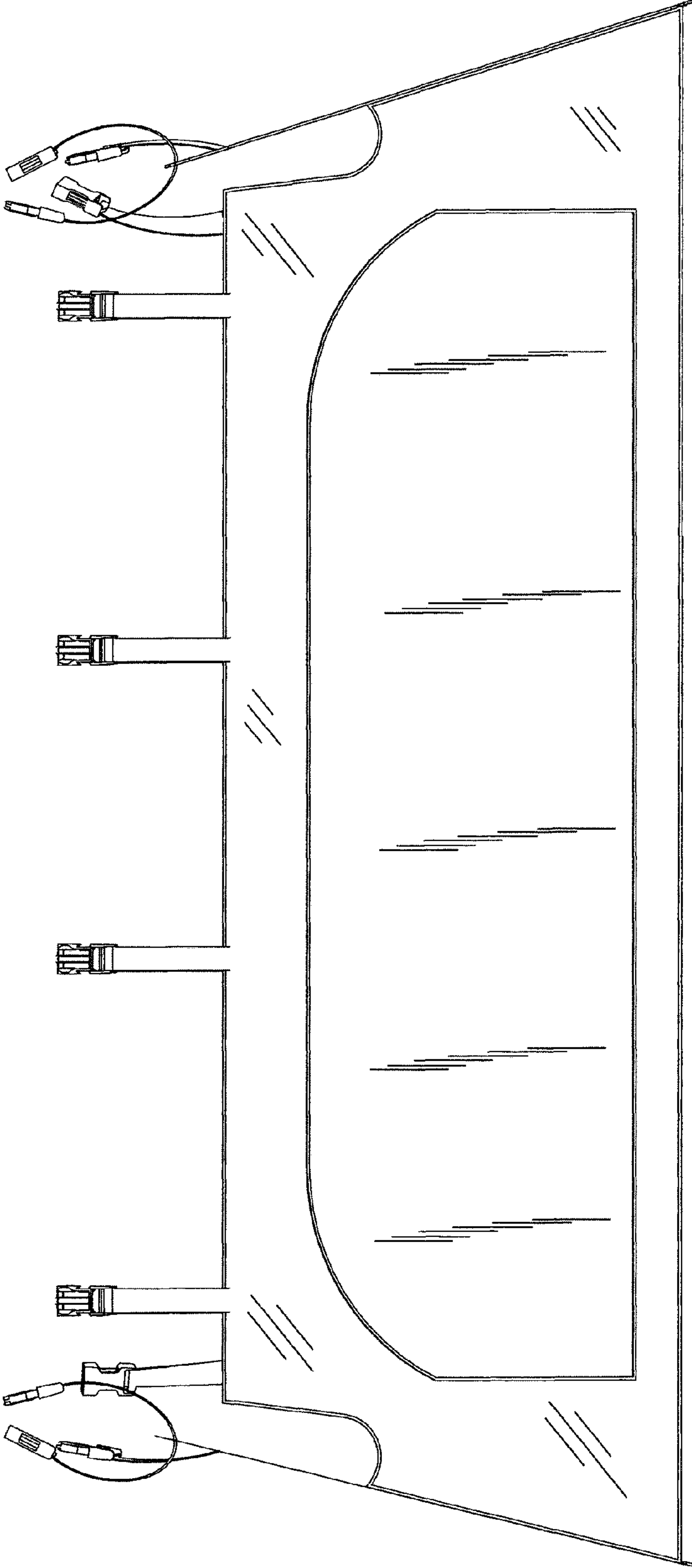

FIG. 3

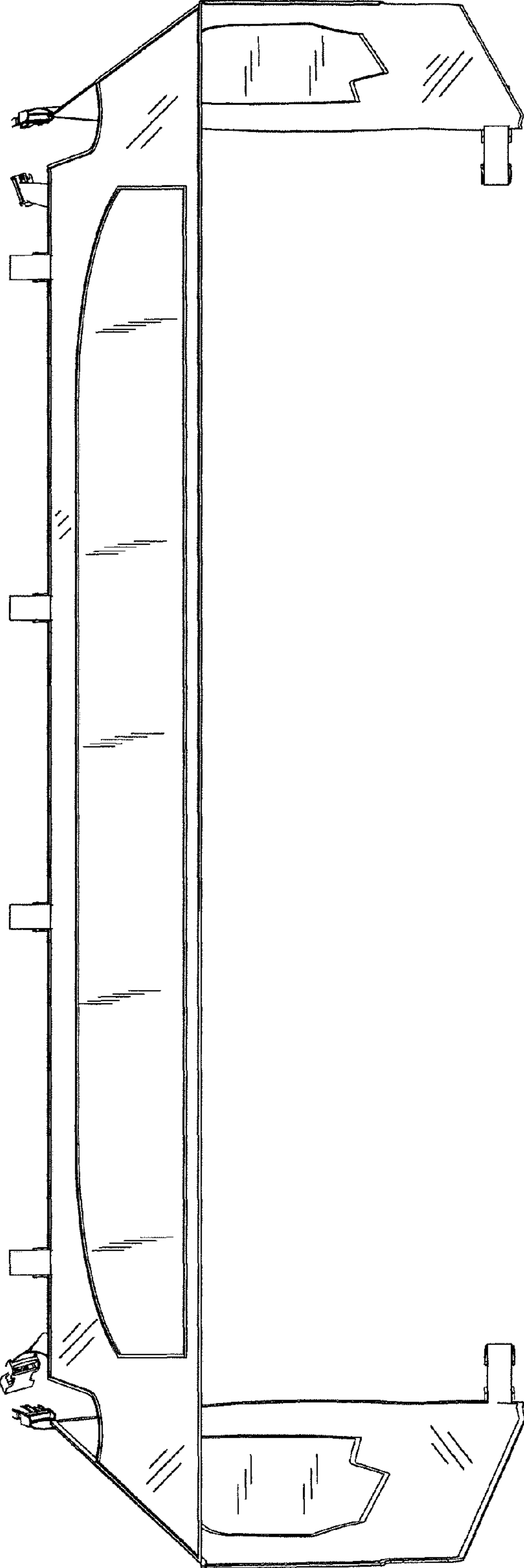

FIG. 4



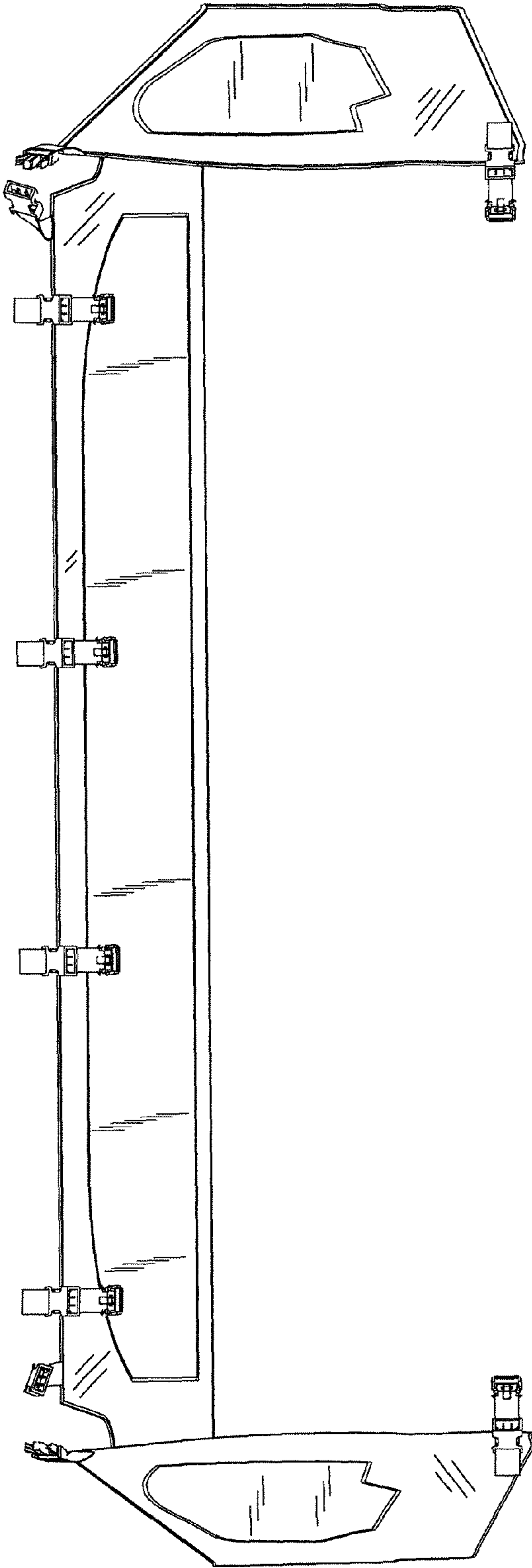

FIG. 5

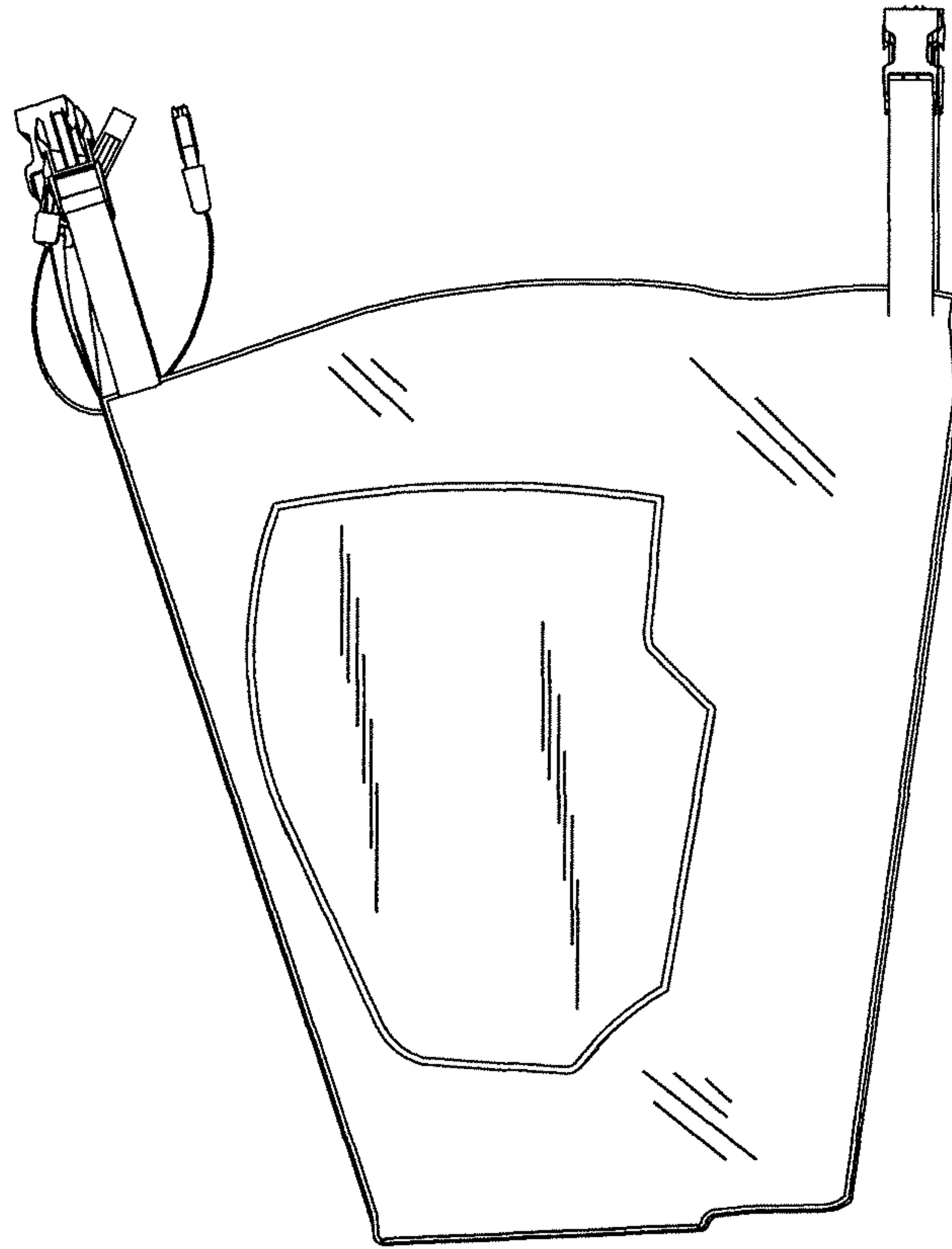

FIG. 6

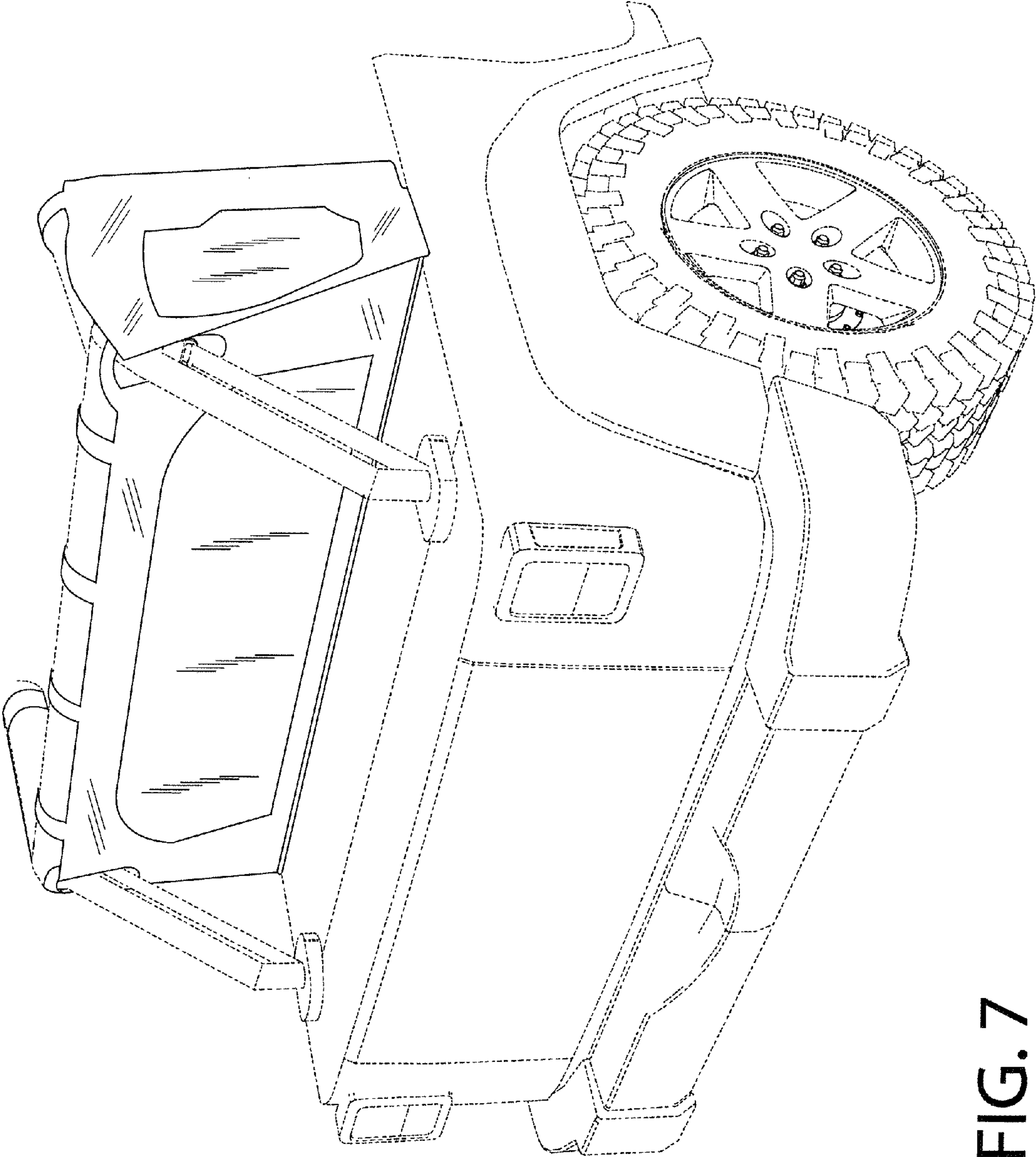

FIG. 7