



US00D707554S

(12) **United States Design Patent**  
**Lavoie**

(10) **Patent No.:** **US D707,554 S**  
(45) **Date of Patent:** **\*\* Jun. 24, 2014**

(54) **CONTAINER**

- (71) Applicant: **MEGA Brands Inc.**, Montreal (CA)
- (72) Inventor: **Andréanne Lavoie**, Lorraine (CA)
- (73) Assignee: **MEGA Brands Inc.**, Montreal, Quebec (CA)
- (\*\*) Term: **14 Years**
- (21) Appl. No.: **29/476,263**
- (22) Filed: **Dec. 12, 2013**
- (51) **LOC (10) Cl.** ..... **09-07**
- (52) **U.S. Cl.**  
USPC ..... **D9/435**
- (58) **Field of Classification Search**  
USPC ..... D9/434, 600, 636, 640, 414, 432, 499;  
D21/484, 500; 446/75, 76, 77, 118;  
D3/270, 271; 273/156, 160; 206/457,  
206/511  
See application file for complete search history.

(56) **References Cited**

**U.S. PATENT DOCUMENTS**

D252,908 S 9/1979 Bayly  
D252,909 S 9/1979 Bayly

(Continued)

**OTHER PUBLICATIONS**

X-Large Lego Storage Brick, earliest date Dec. 17, 2011. Found online at <http://www.containerstore.com/shop/toyStorage/boxedCases?productId=10031697>.\*

(Continued)

*Primary Examiner* — Robert M Spear

(74) *Attorney, Agent, or Firm* — Plumsea Law Group, LLC

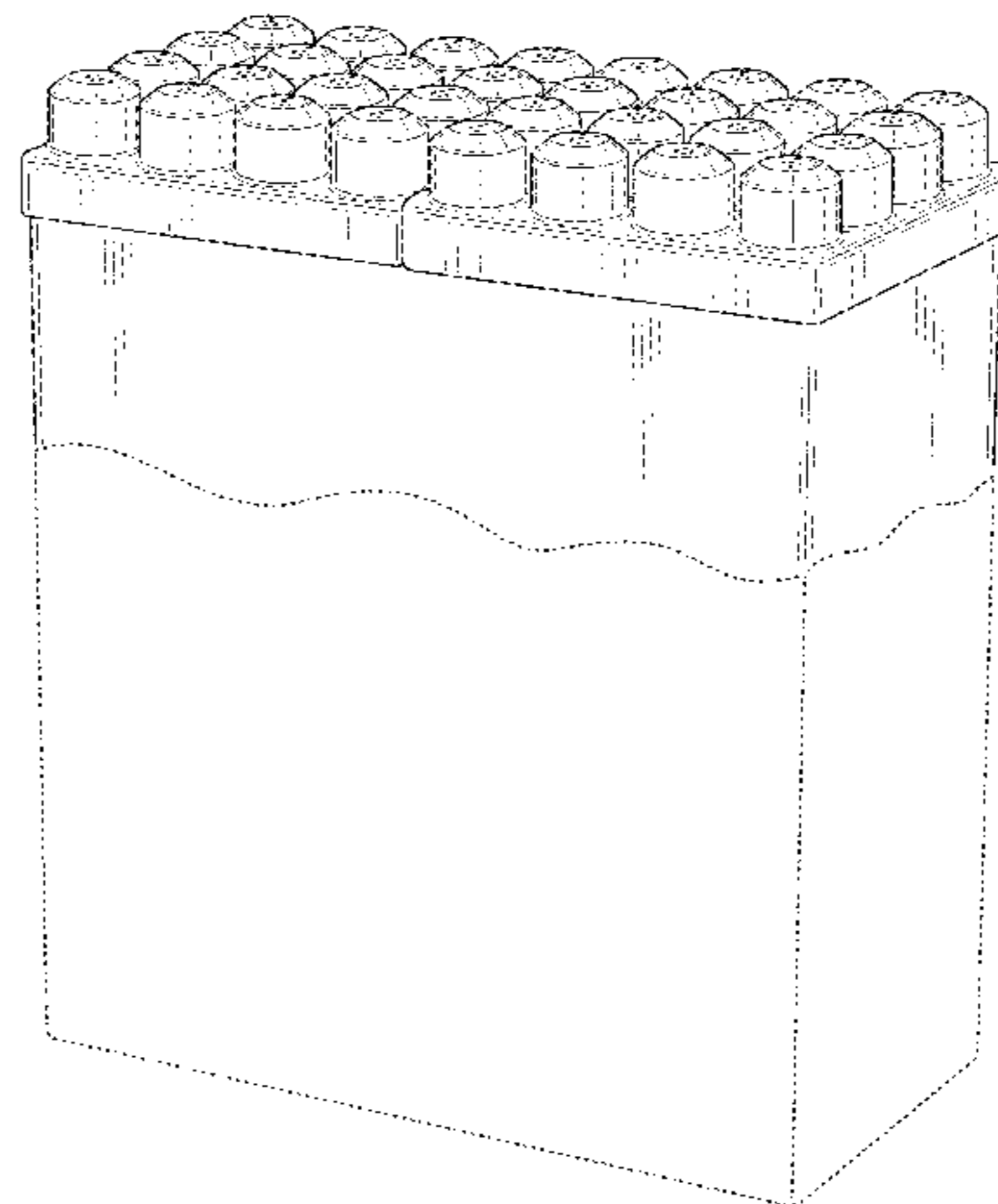
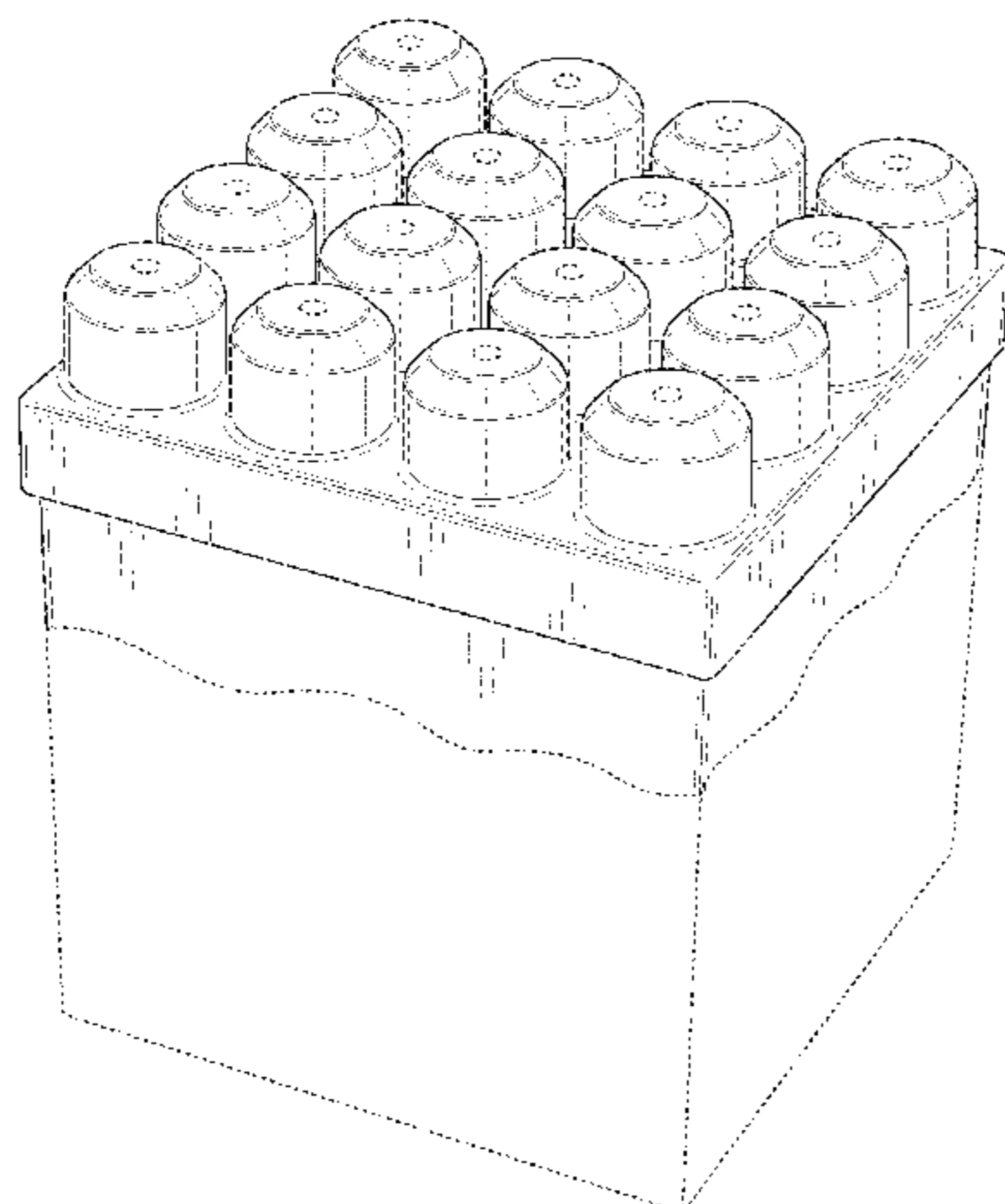
(57) **CLAIM**

The ornamental design for a container, as shown and described.

**DESCRIPTION**

FIG. 1 is a top front perspective view of a container showing the new design;  
 FIG. 2 is a front side elevational view of the container of FIG. 1;  
 FIG. 3 is a rear side elevational view of the container of FIG. 1;  
 FIG. 4 is a right side elevational view of the container of FIG. 1;  
 FIG. 5 is a left side elevational view of the container of FIG. 1;  
 FIG. 6 is a top plan view of the container of FIG. 1;  
 FIG. 7 is a bottom plan view of the container of FIG. 1;  
 FIG. 8 is a top front perspective view of a second embodiment;  
 FIG. 9 is a front side elevational view of the container of FIG. 8;  
 FIG. 10 is a rear side elevational view of the container of FIG. 8;  
 FIG. 11 is a right side elevational view of the container of FIG. 8;  
 FIG. 12 is a left side elevational view of the container of FIG. 8;  
 FIG. 13 is a top plan view of the container of FIG. 8;  
 FIG. 14 is a bottom plan view of the container of FIG. 8;  
 FIG. 15 is a top front perspective view of a third embodiment;  
 FIG. 16 is a front side elevational view of the container of FIG. 15;  
 FIG. 17 is a rear side elevational view of the container of FIG. 15;  
 FIG. 18 is a right side elevational view of the container of FIG. 15;  
 FIG. 19 is a left side elevational view of the container of FIG. 15;  
 FIG. 20 is a top plan view of the container of FIG. 15; and,  
 FIG. 21 is a bottom plan view of the container of FIG. 15.  
 The broken lines in the drawings represent unclaimed environmental subject matter and form no part of the claim.

**1 Claim, 21 Drawing Sheets**



(56)

References Cited

U.S. PATENT DOCUMENTS

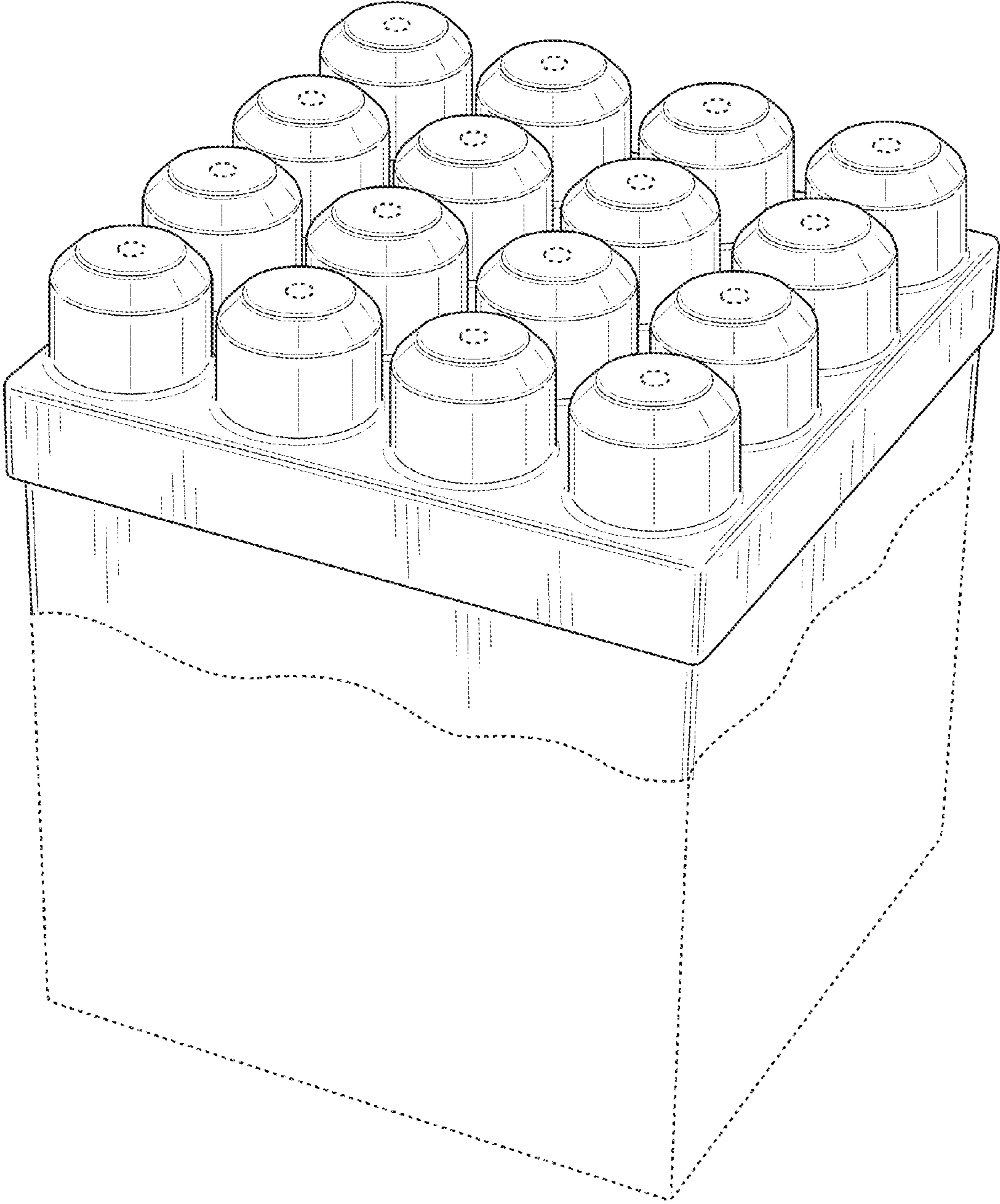
D252,910 S 9/1979 Bayly  
 D252,977 S 9/1979 Bayly  
 D252,978 S 9/1979 Bayly  
 D252,979 S 9/1979 Bayly  
 D252,980 S 9/1979 Bayly  
 D252,981 S 9/1979 Fenton  
 D286,417 S \* 10/1986 Takahashi ..... D21/500  
 D294,373 S \* 2/1988 Bertrand ..... D21/495  
 D295,093 S 4/1988 Tapdrup  
 D295,094 S 4/1988 Tapdrup  
 D296,023 S 5/1988 Tapdrup  
 4,809,980 A \* 3/1989 Bertrand ..... 273/157 R  
 4,822,314 A 4/1989 O'Brian et al.  
 D301,260 S 5/1989 McLaughlin et al.  
 D308,705 S 6/1990 Olsen  
 D309,332 S 7/1990 Olsen  
 D321,648 S \* 11/1991 Ricci ..... D9/600  
 D324,964 S 3/1992 Ryaa  
 D325,477 S \* 4/1992 Poulsen et al. .... D6/432  
 D327,185 S 6/1992 Ryaa  
 D328,201 S 7/1992 Ryaa  
 5,188,221 A \* 2/1993 Bertrand ..... 206/736  
 D342,555 S 12/1993 Berggreen  
 D343,355 S 1/1994 Bertrand  
 D350,787 S 9/1994 Hojlund et al.  
 D351,005 S 9/1994 Hojlund et al.  
 D355,763 S 2/1995 Sun  
 D357,410 S 4/1995 Rask et al.  
 D359,523 S \* 6/1995 Yeung ..... D21/501  
 D360,908 S 8/1995 Ruskai  
 D363,515 S 10/1995 Mathiesen  
 D364,656 S 11/1995 Ruskai  
 D365,756 S 1/1996 Rask et al.  
 D370,035 S \* 5/1996 Olsen ..... D21/491  
 D373,151 S 8/1996 Mathiesen  
 D378,838 S \* 4/1997 Olsen et al. .... D21/486  
 5,674,103 A \* 10/1997 Bean ..... 446/75  
 5,676,251 A 10/1997 Credle, Jr.  
 D389,408 S 1/1998 Rask et al.  
 5,709,304 A 1/1998 Credle, Jr.  
 D394,680 S \* 5/1998 Andersen ..... D21/495  
 5,876,776 A 3/1999 Credle, Jr.  
 D408,142 S 4/1999 Song  
 5,890,595 A 4/1999 Credle, Jr.  
 D426,933 S 6/2000 Redfern  
 D442,779 S 5/2001 Koefeld et al.  
 D487,544 S 3/2004 Jessen et al.  
 7,252,196 B1 8/2007 Koefeld et al.  
 7,416,166 B1 8/2008 Shaw  
 7,537,119 B2 5/2009 Becklin

7,740,138 B2 6/2010 Becklin  
 8,002,241 B1 8/2011 Shaw  
 D652,952 S 1/2012 Angel  
 D694,703 S 12/2013 Faro  
 D695,626 S \* 12/2013 Webster et al. .... D9/669

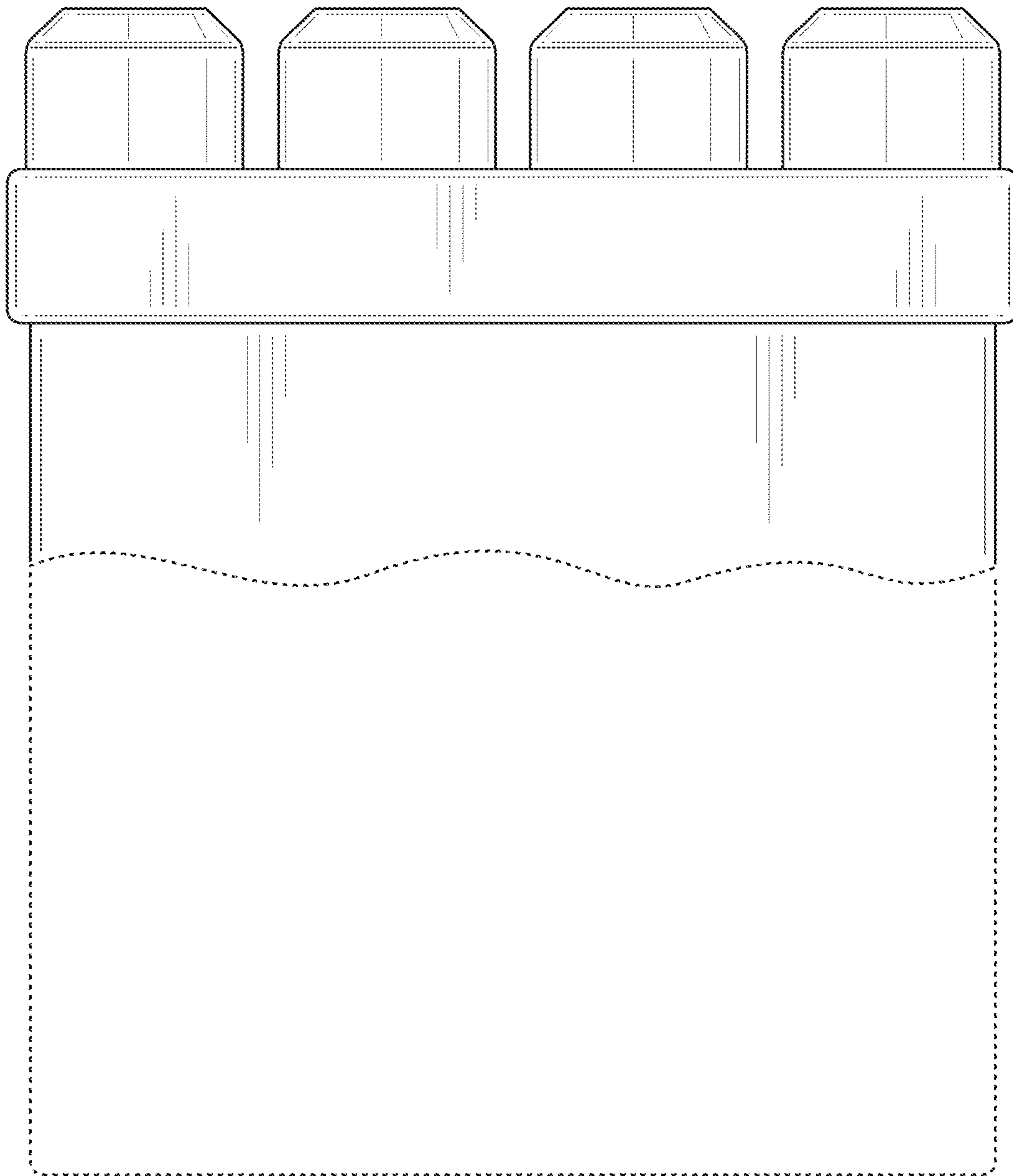
OTHER PUBLICATIONS

“Contain This! The Container Store Opens in Las Vegas”, Toni Spilsbury.com; p. 8 of 19; dated May 22, 2012. Found online at <http://tonispilsbury.com/contain/>.  
 Mega Bloks First Builders Recue Centerad, Target.com, earliest date Dec. 22, 2012; found online at [http://www.target.com/p/mega-bloks-first-builders-recue-center/-/A-14079461?ref=tgt\\_adv\\_XSG10001&AFID=Google\\_PLA\\_df&LNM=%7C14079461&CPNG=Toys&kpid=14079461&LID=PA&ci\\_src=17588969&ci\\_sku=14079461&gclid=COvR85v037sCFSLxOgodwzQAbg](http://www.target.com/p/mega-bloks-first-builders-recue-center/-/A-14079461?ref=tgt_adv_XSG10001&AFID=Google_PLA_df&LNM=%7C14079461&CPNG=Toys&kpid=14079461&LID=PA&ci_src=17588969&ci_sku=14079461&gclid=COvR85v037sCFSLxOgodwzQAbg).  
 Web page printout, Mega Brands Mega Play My Knight's Castle, Aug. 21, 2013, 3 pages, retrieved from <http://web.archive.org/web/20130821180059/http://www.megabloks.com/en-us/shop/construction-toys/mega-play/my-knights-castle>.  
 Web page printout from Brick Link (<http://www.bricklink.com/>), Fun with Bricks, Part 4628-1, 2012, 2 pages.  
 Web page printout from Brick Link (<http://www.bricklink.com/>), Lego Duplo XXL Box, Part 5511-1, 2010, 2 pages.  
 Web page printout from Brick Link (<http://www.bricklink.com/>), Lego XXL Box, Part 5512-1, 2010, 2 pages.  
 Web page printout from Brick Link (<http://www.bricklink.com/>), Lego Building Fun, Part 5549-1, 2010, 2 pages.  
 Mega Play Giant Adventure Castle Instruction Manual, 2003, 7 pages.  
 Mega Play My Own Home Instruction Manual, 2003, 11 pages.  
 Excerpt of 1997 Mega Bloks Catalog, 3 pages.  
 Excerpt of 1998 Mega Bloks Catalog, 2 pages.  
 Excerpt of 2000 Mega Bloks Catalog, 2 pages.  
 Excerpt of 2002 Mega Bloks Catalog, 2 pages.  
 Excerpt of 2003 Mega Bloks Catalog, 3 pages.  
 Excerpt of 2004 Mega Bloks Catalog, 3 pages.  
 Excerpt of 2006 Mega Bloks Catalog, 2 pages.  
 Excerpt of 2007 Mega Bloks Catalog, 2 pages.  
 Excerpt of 2011 Mega Bloks Catalog, 3 pages.  
 Excerpt of 2012 Mega Bloks Catalog, 4 pages.  
 Excerpt of 2013 Mega Bloks Catalog, 3 pages.  
 Web page printout from Lego (<http://www.brickset.com/detail/?set=5931-1>), 5931-1 My First Lego Duplo Set, 4 pages, Jan. 24, 2014.  
 Web page printout from Lego (<http://guide.lugnet.com/set/5931>), 5931 My First Lego Duplo Set, 1 page, Jan. 24, 2014.  
 Office Action mailed Apr. 4, 2014 in U.S. Appl. No. 29/481,711.

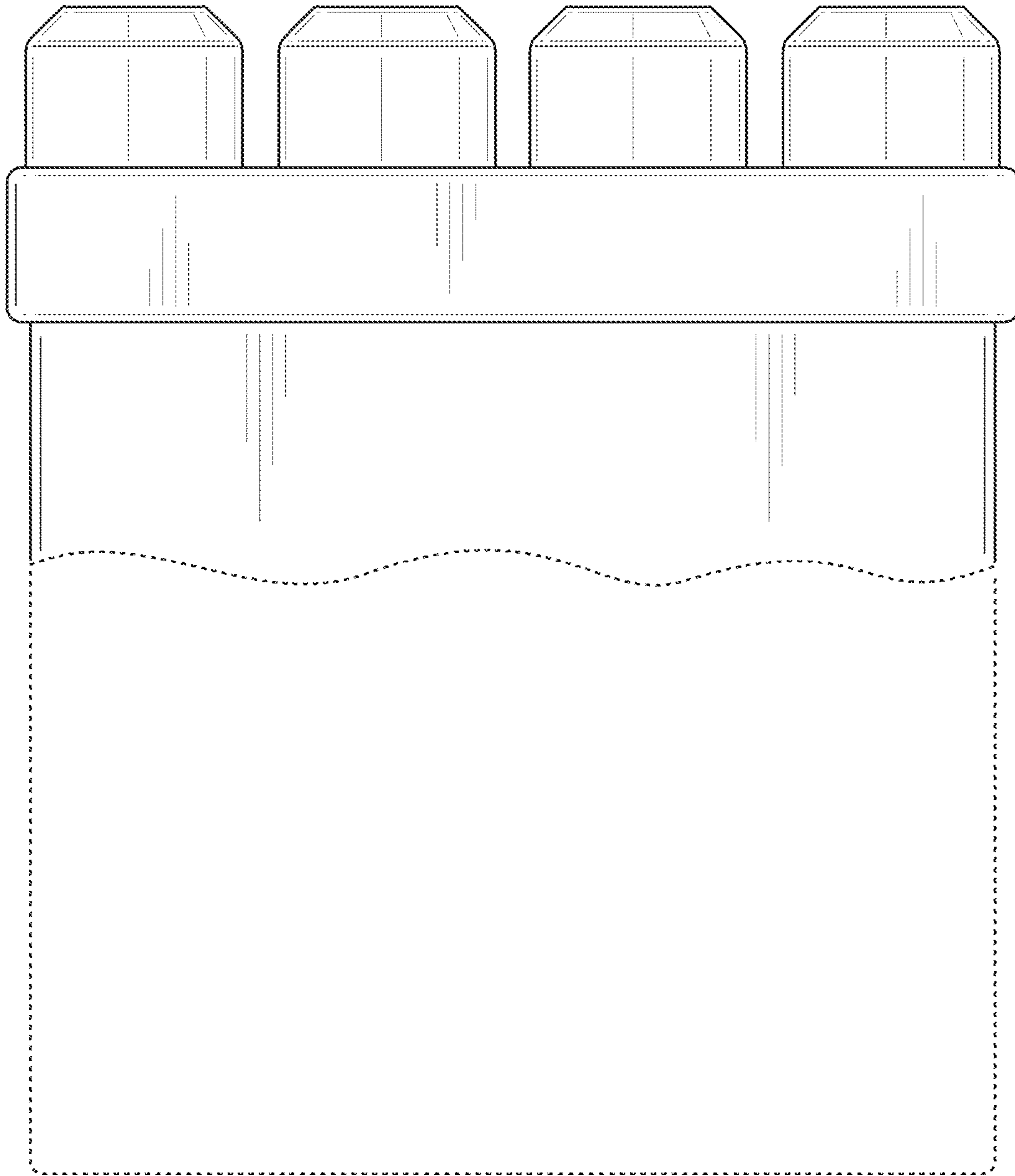
\* cited by examiner



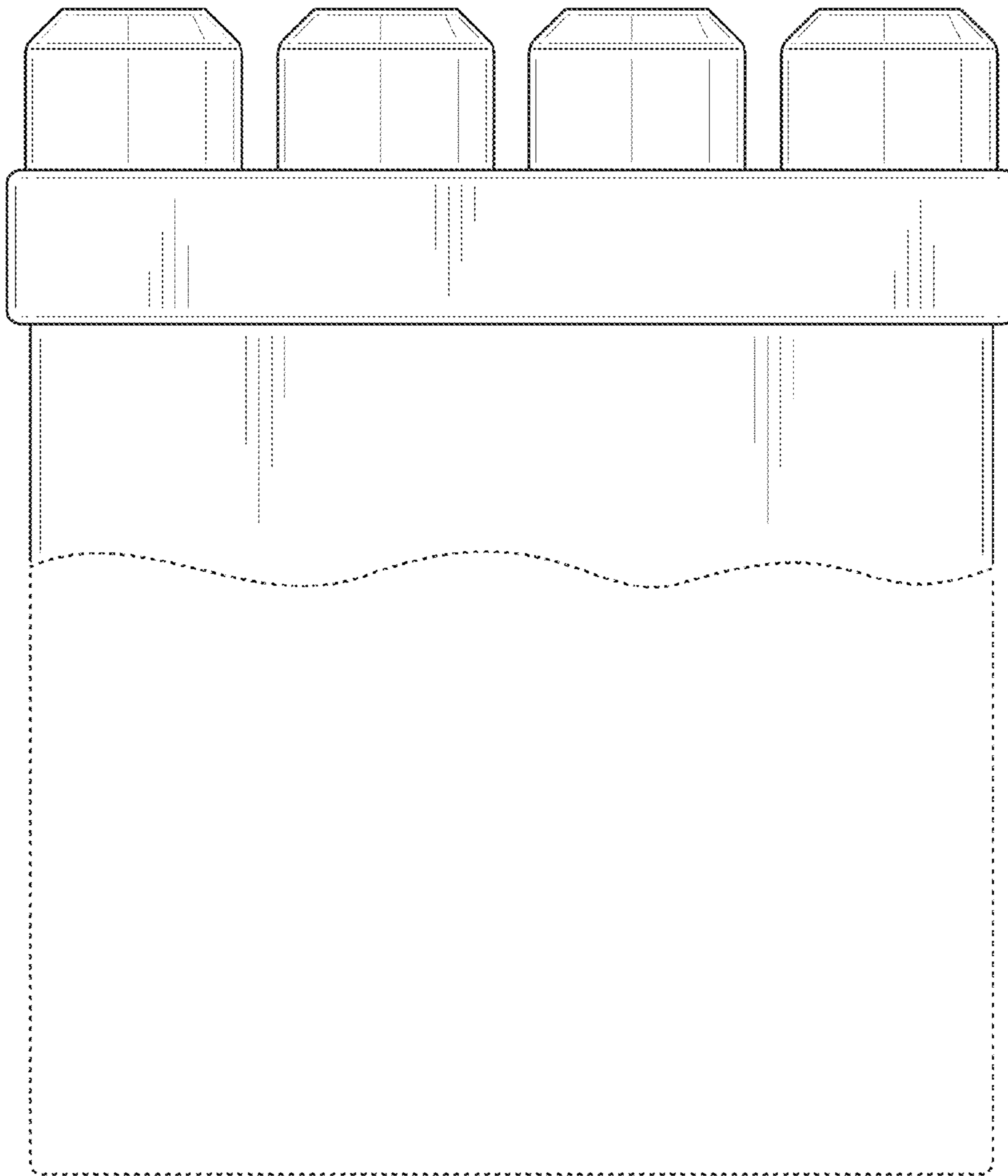
**FIG. 1**



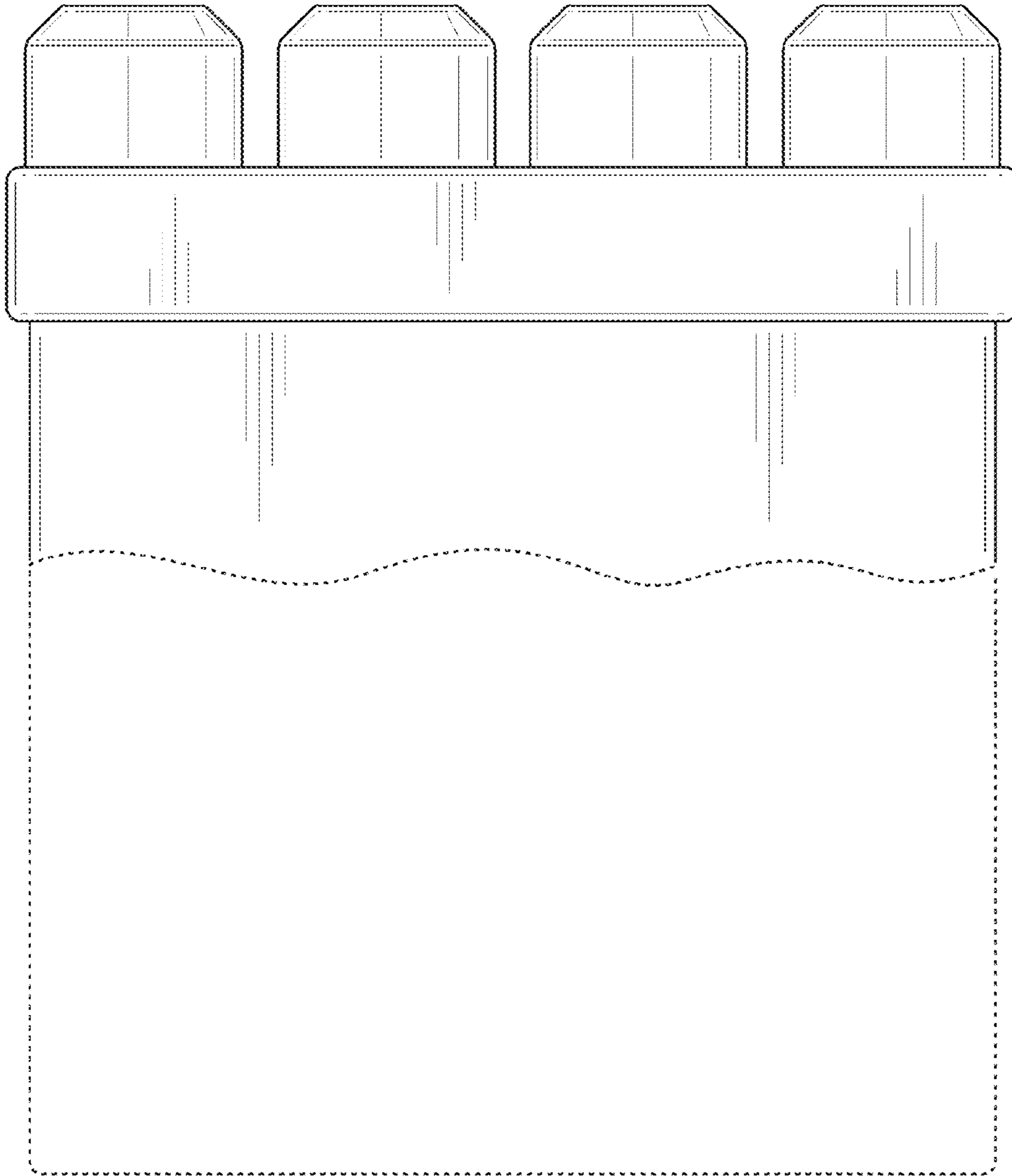
**FIG. 2**



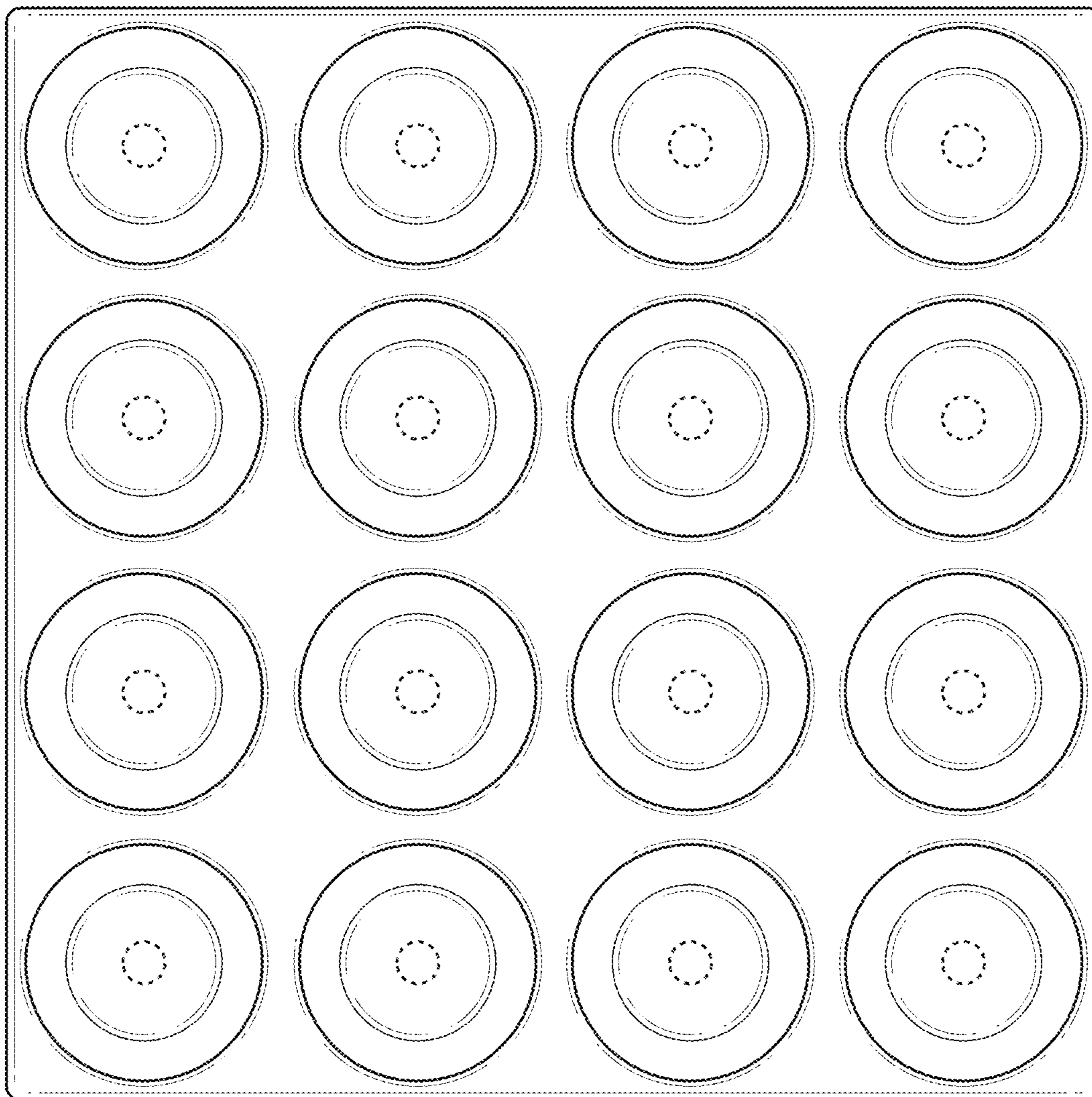
**FIG. 3**



**FIG. 4**

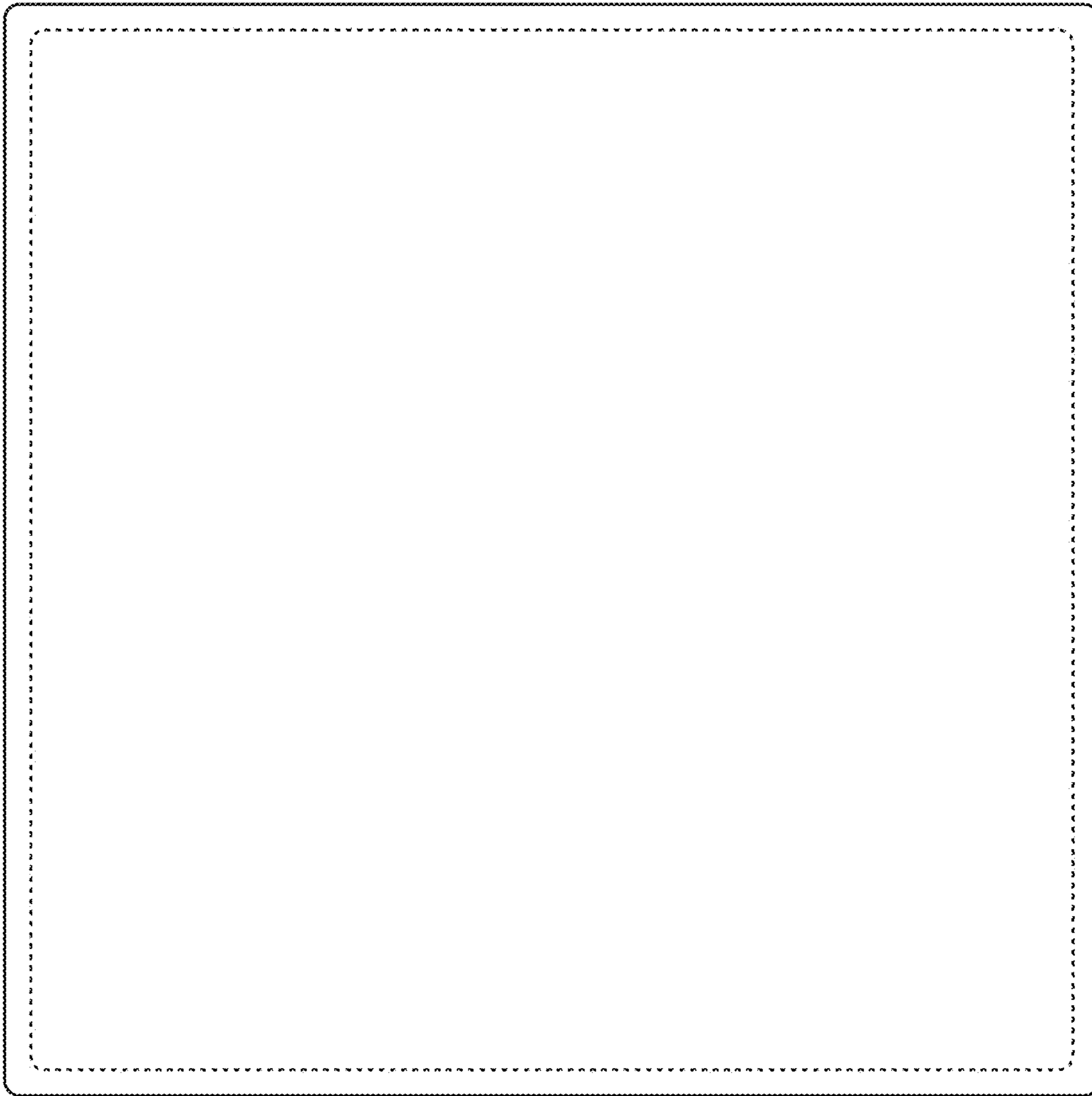


**FIG. 5**

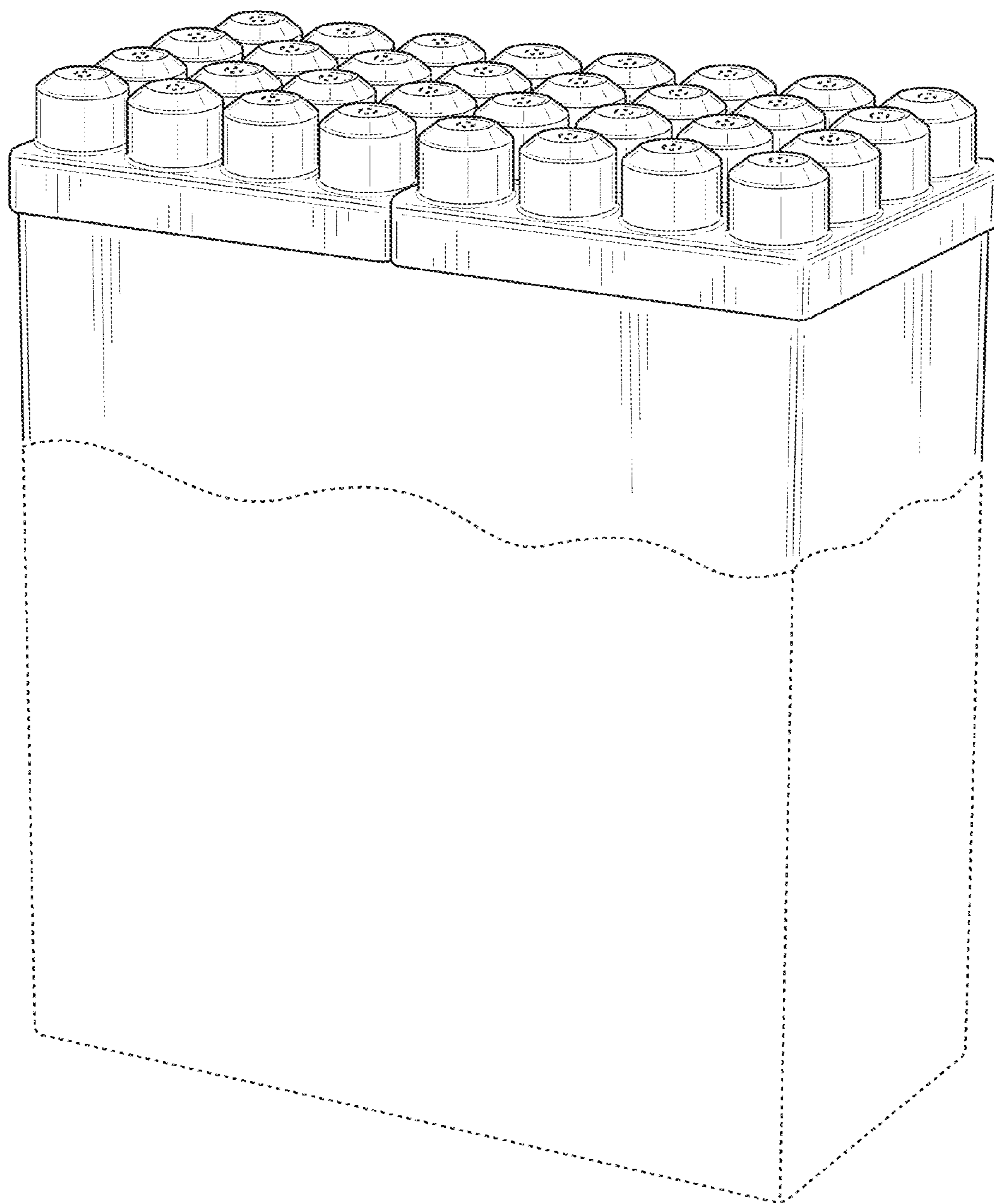


**FIG. 6**

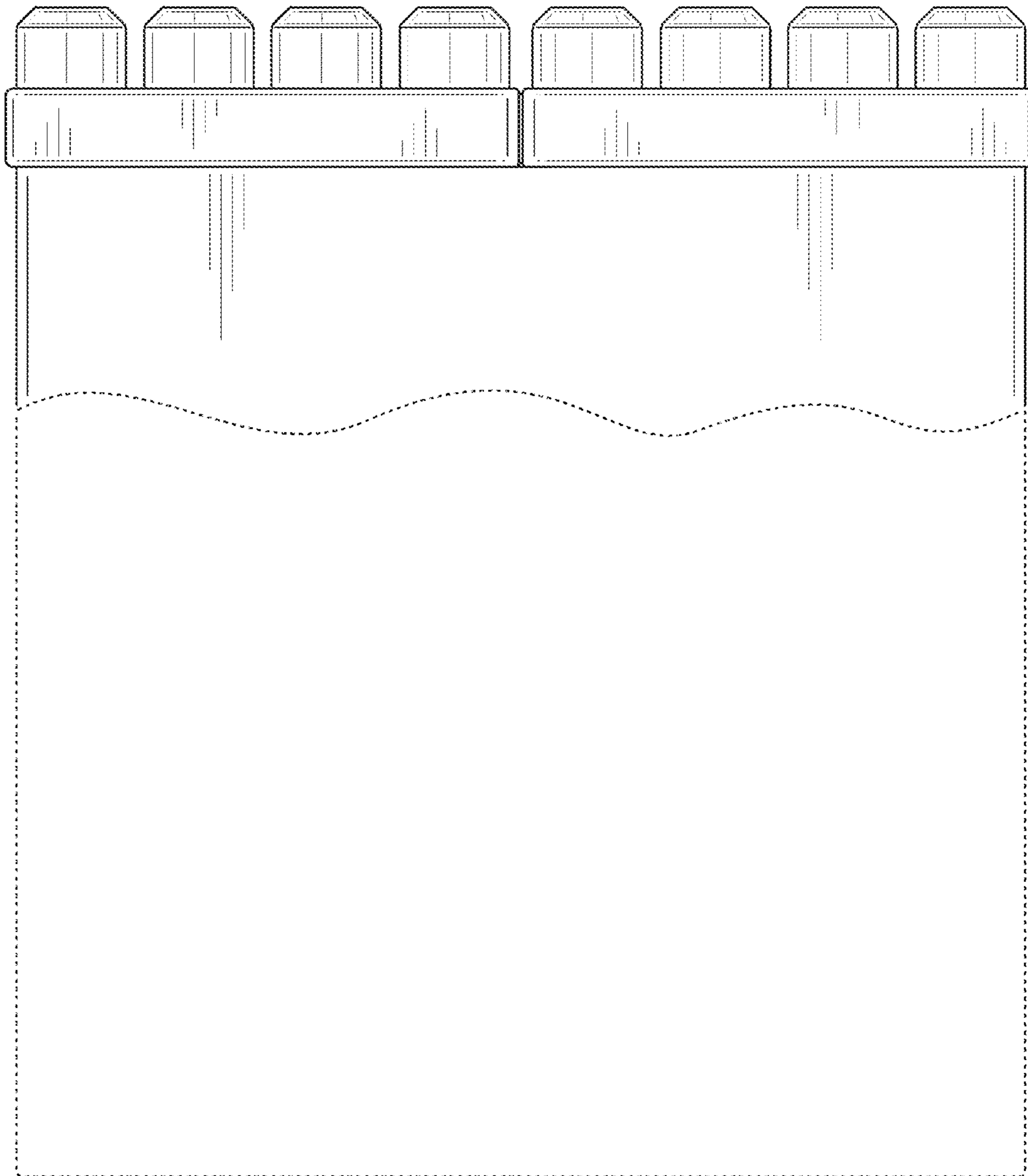




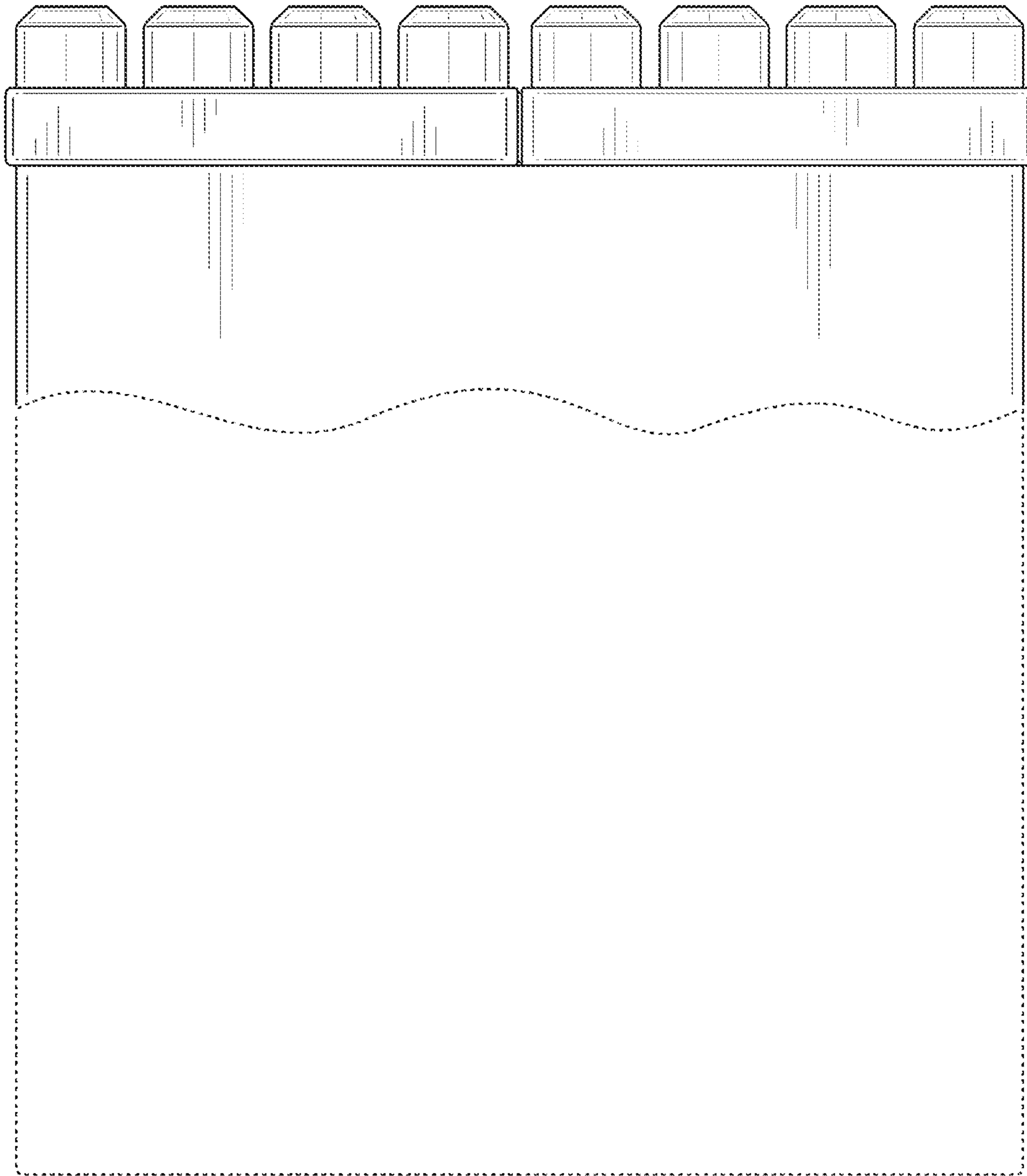
***FIG. 7***



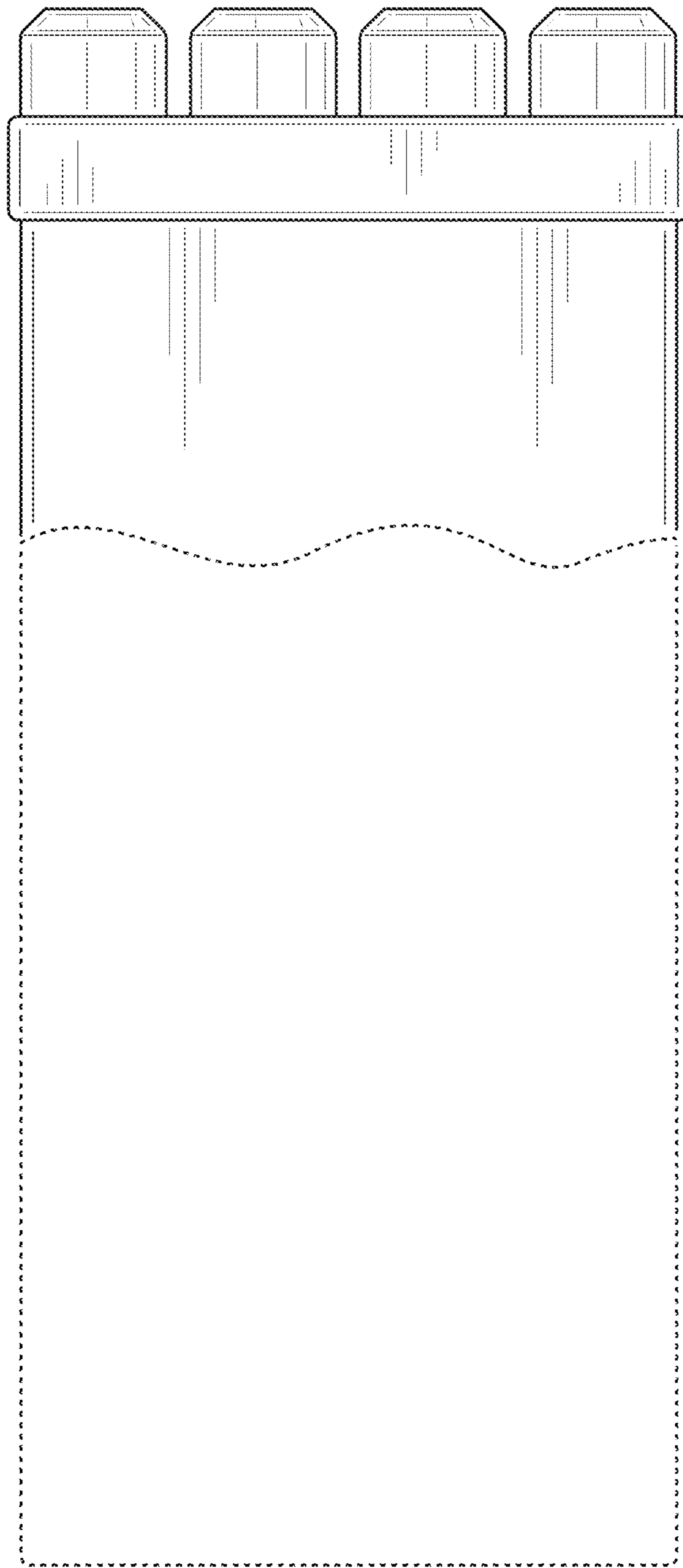
**FIG. 8**



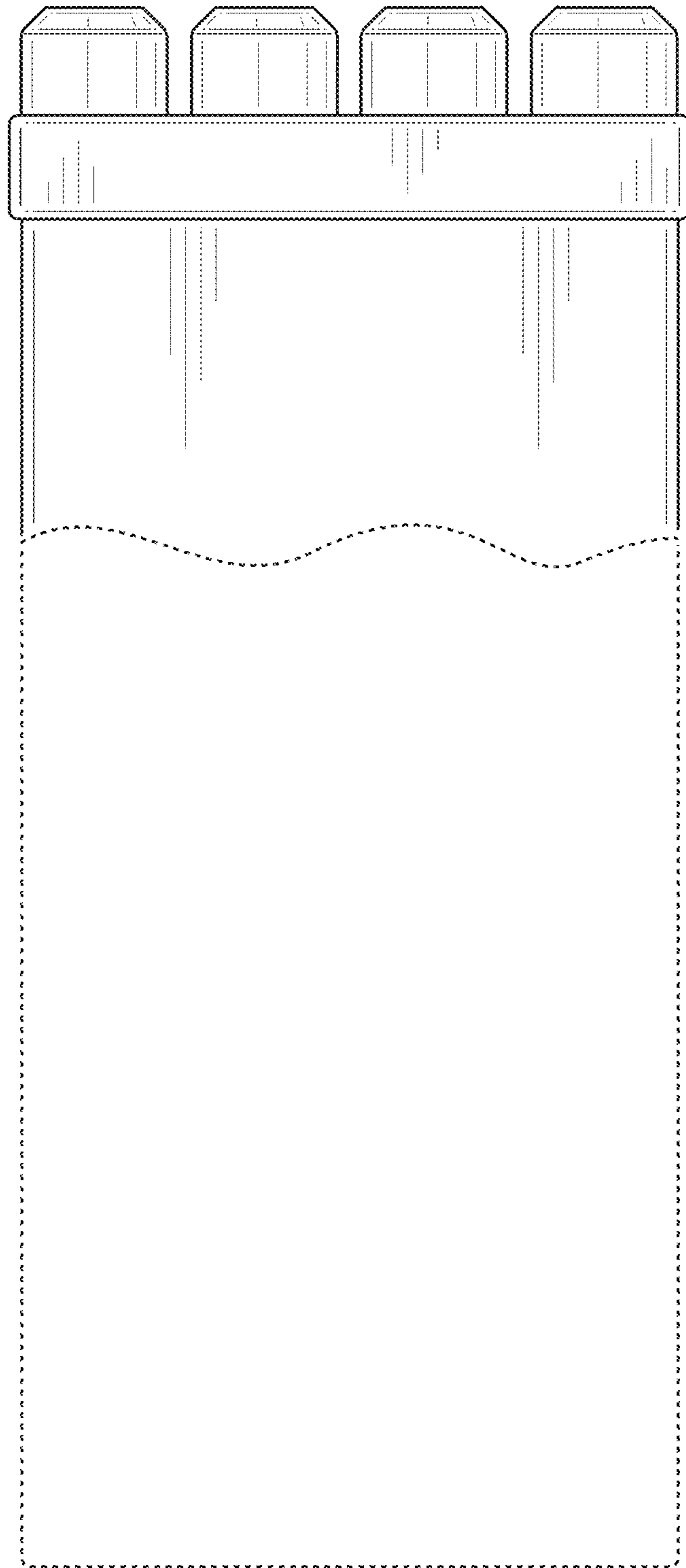
**FIG. 9**



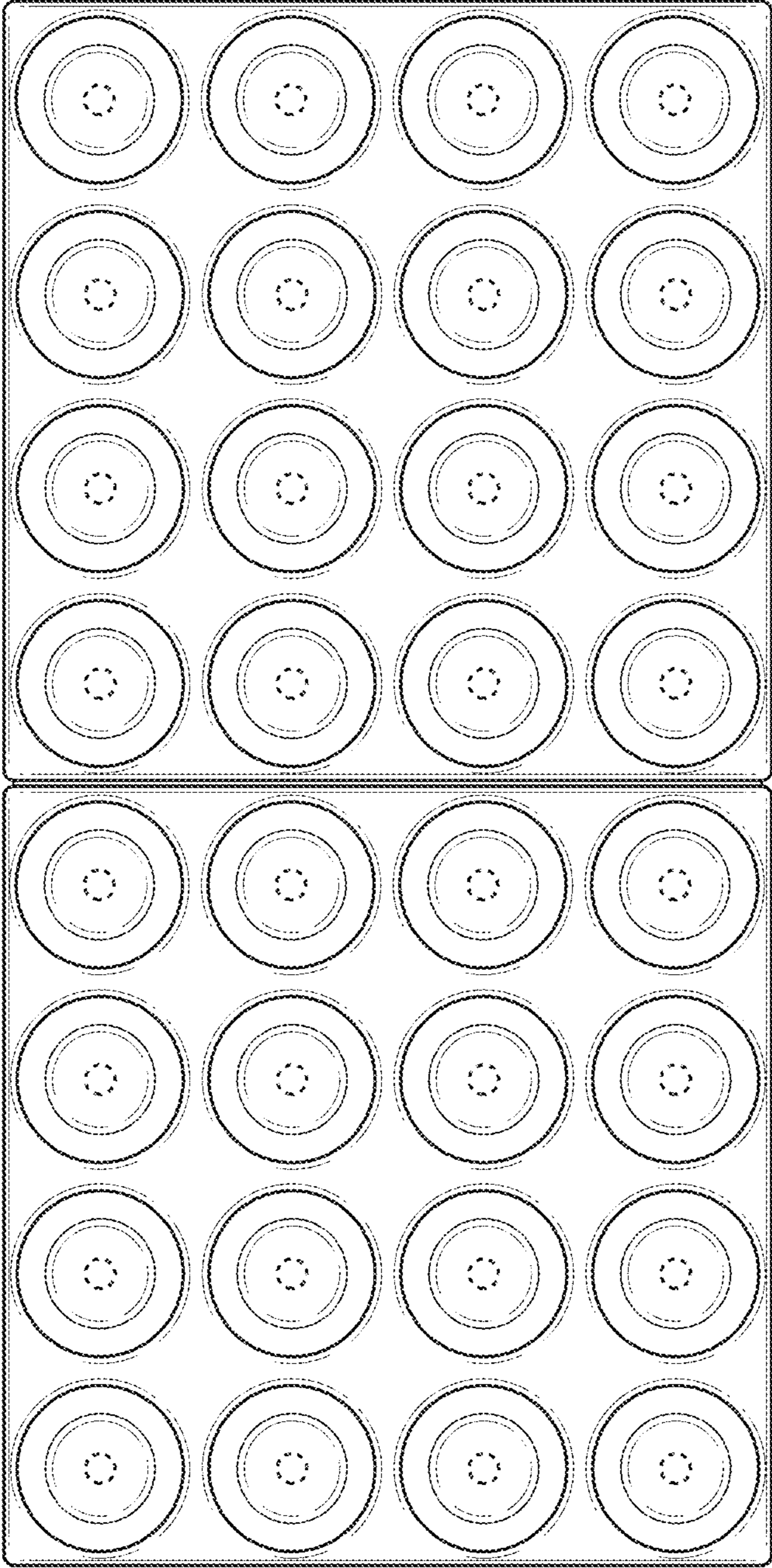
**FIG. 10**



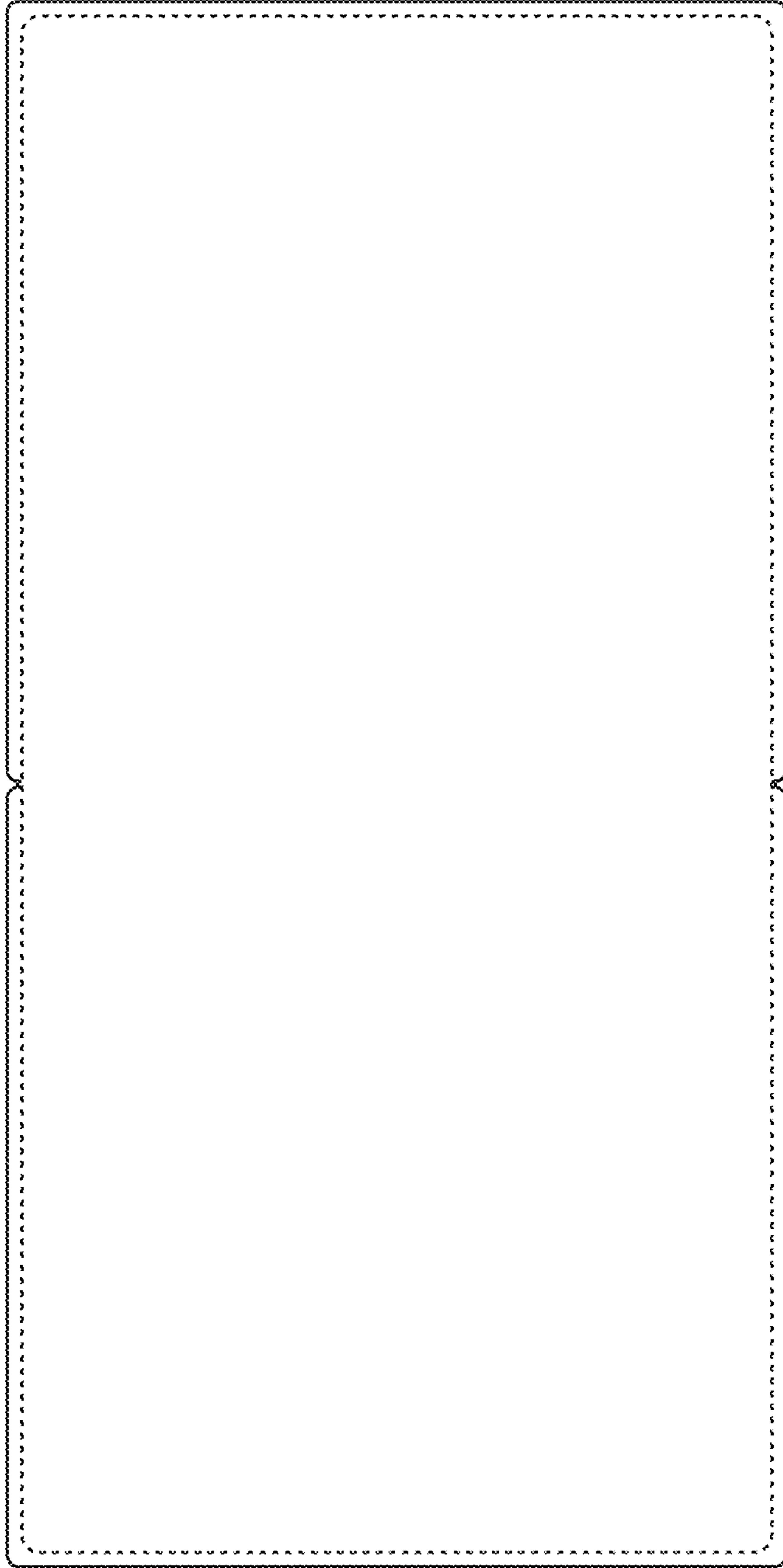
**FIG. 11**



**FIG. 12**

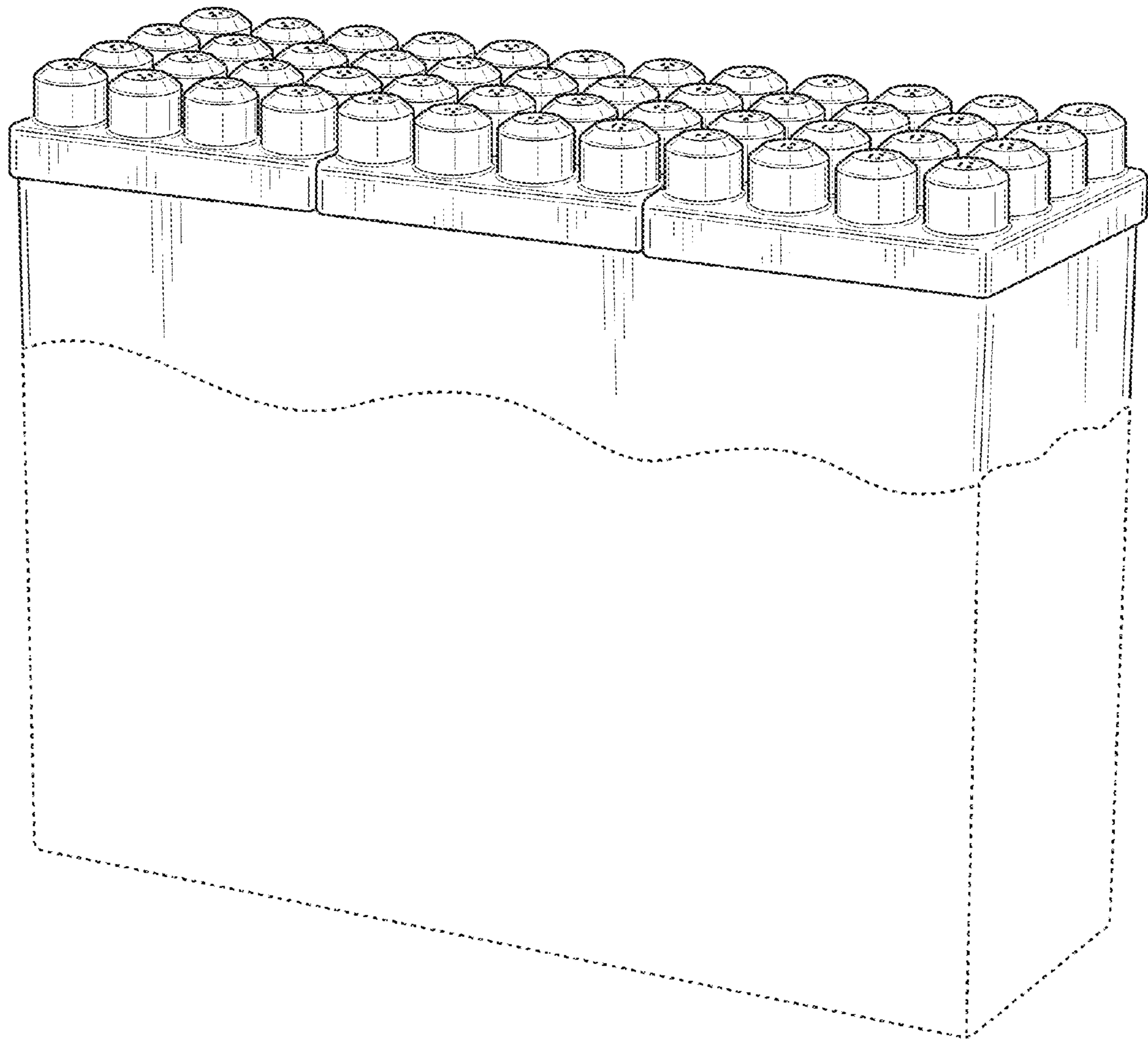


**FIG. 13**

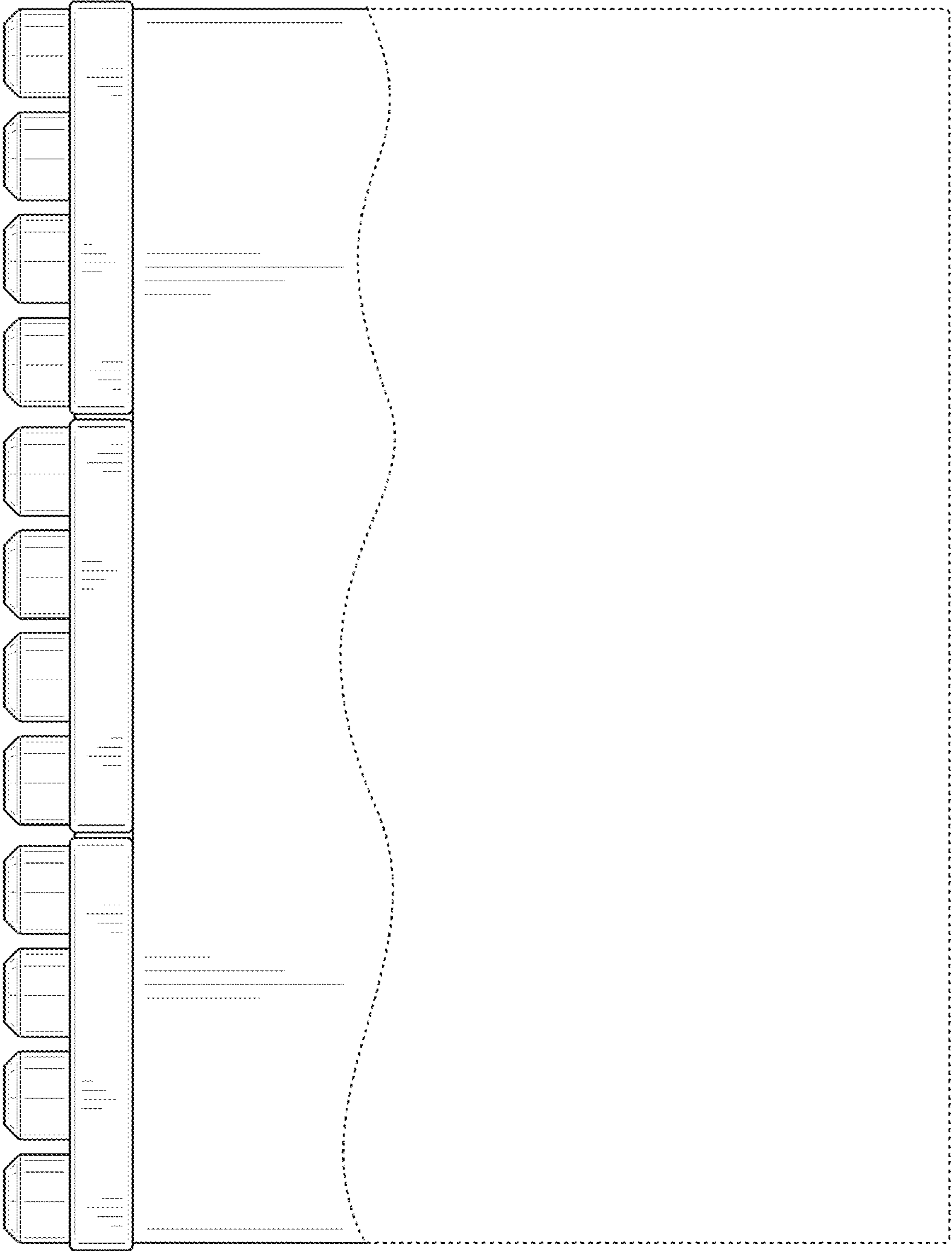


**FIG. 14**





**FIG. 15**



**FIG. 16**

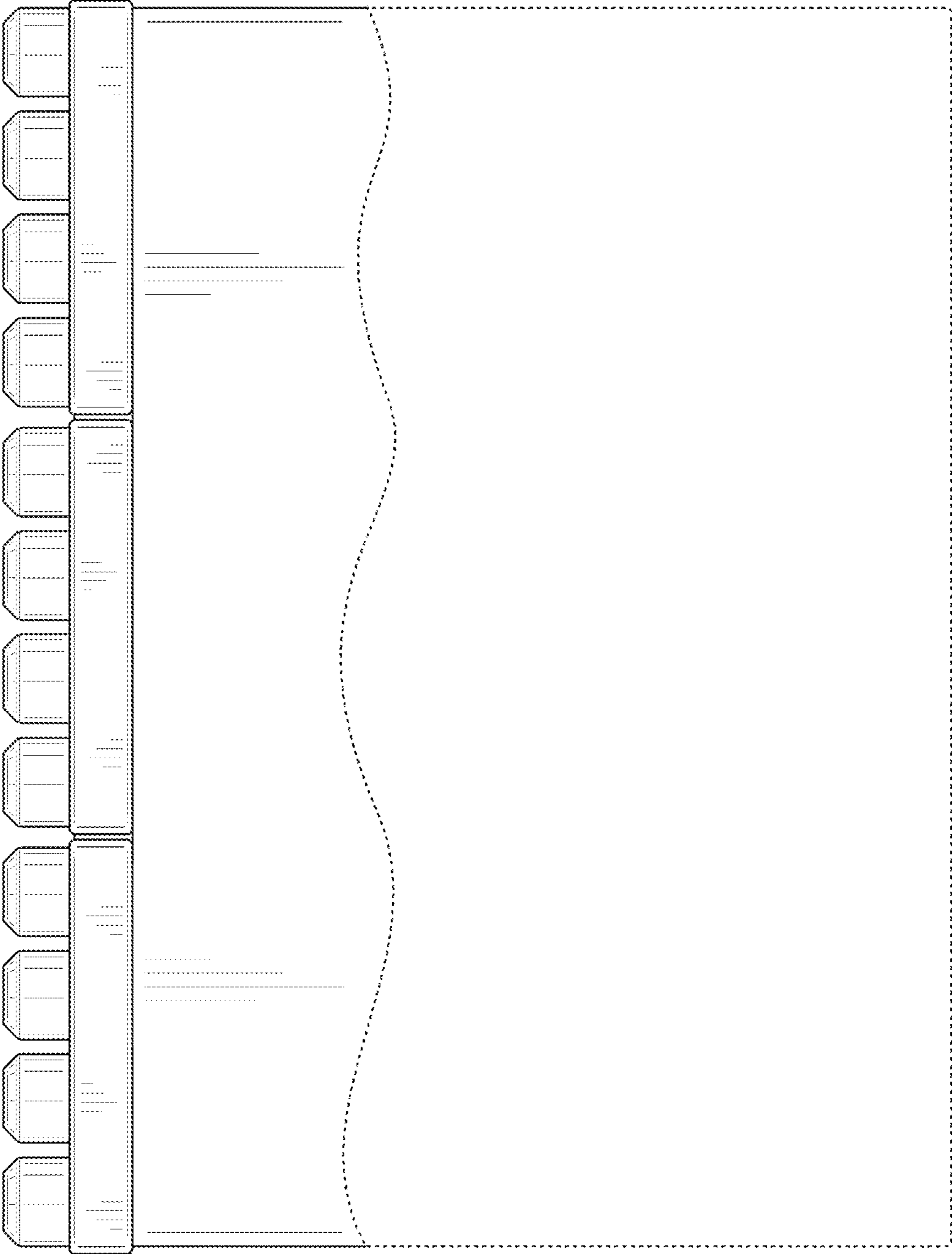
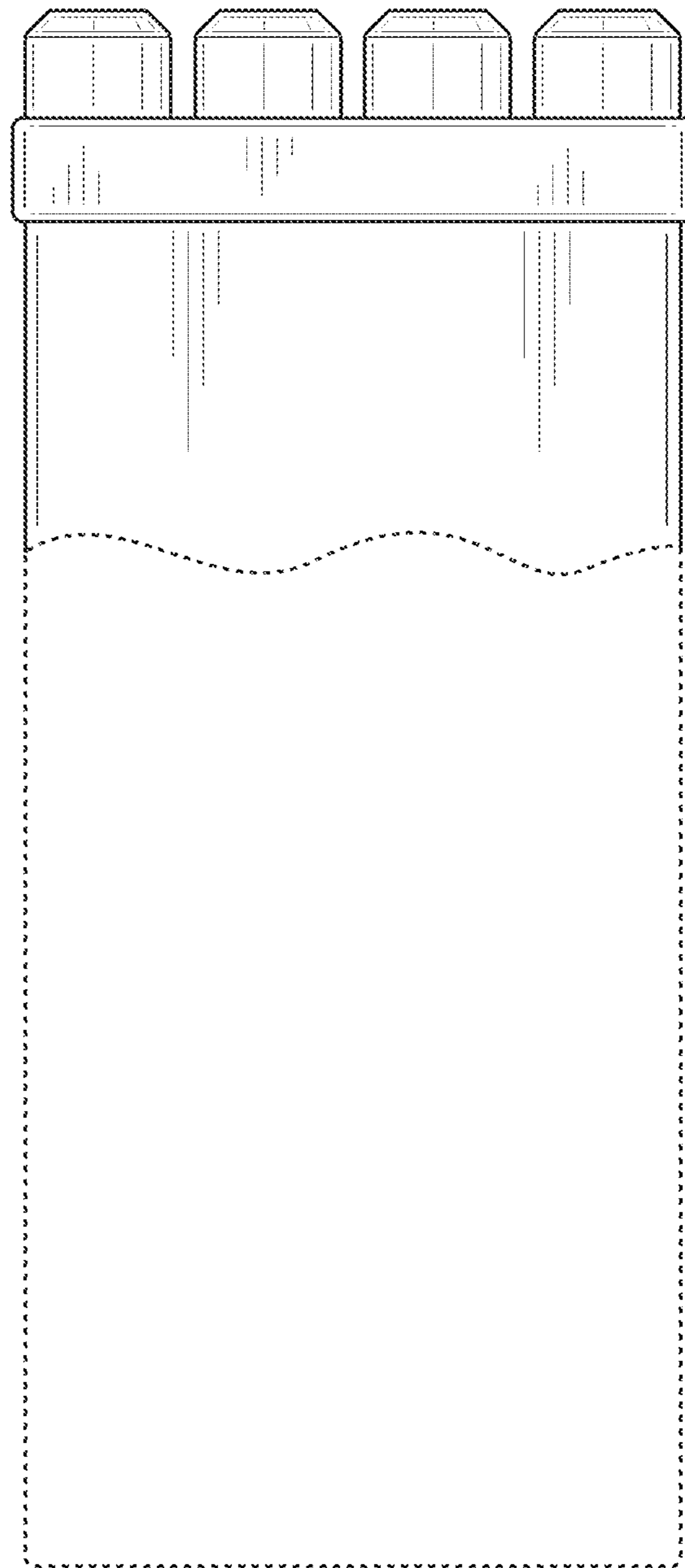
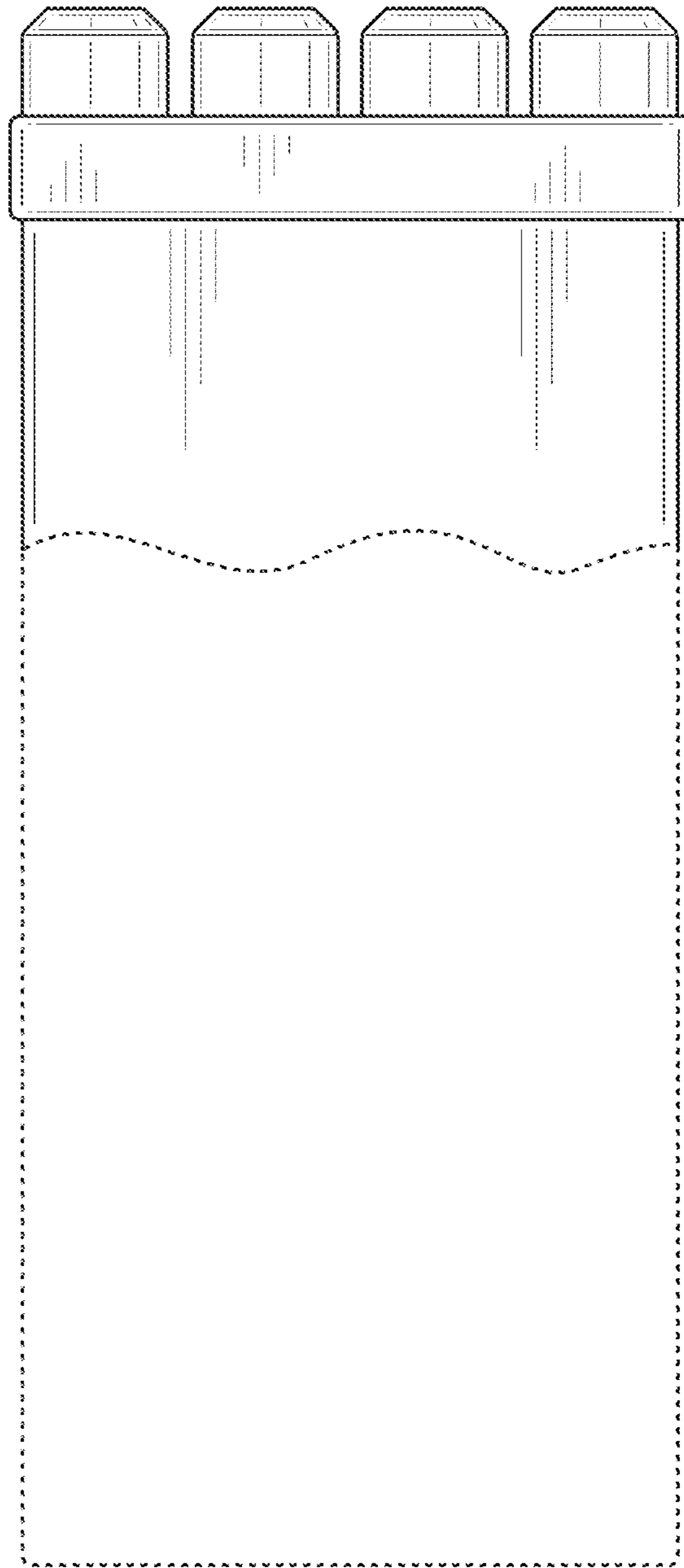


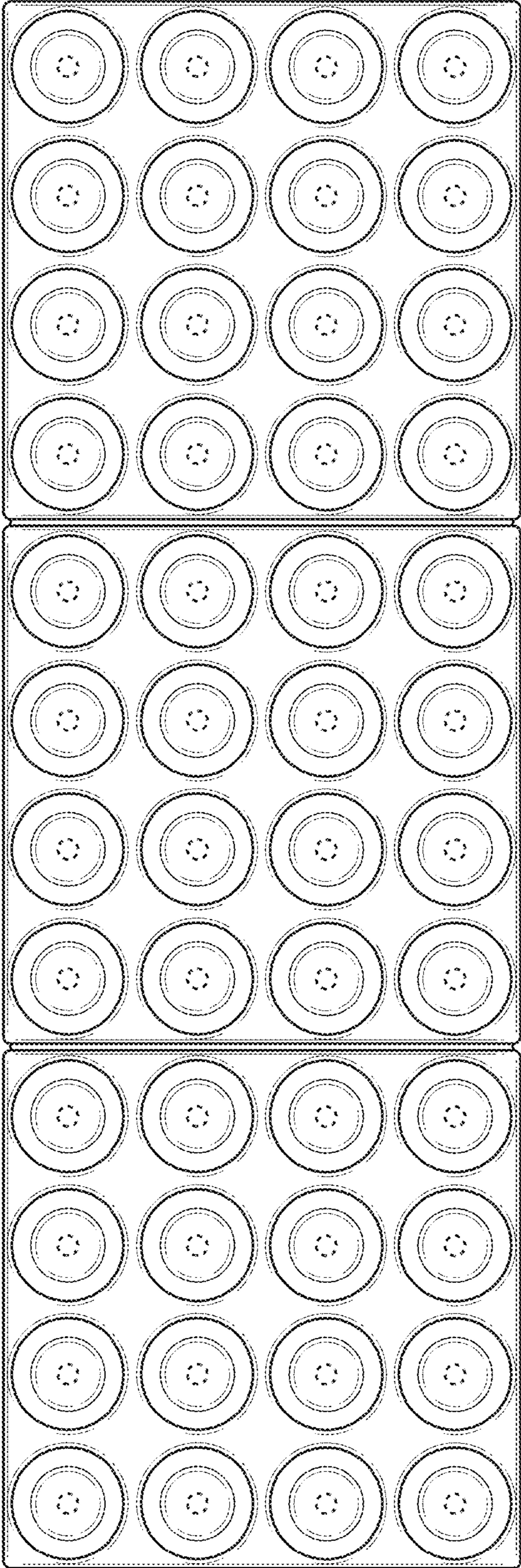
FIG. 17



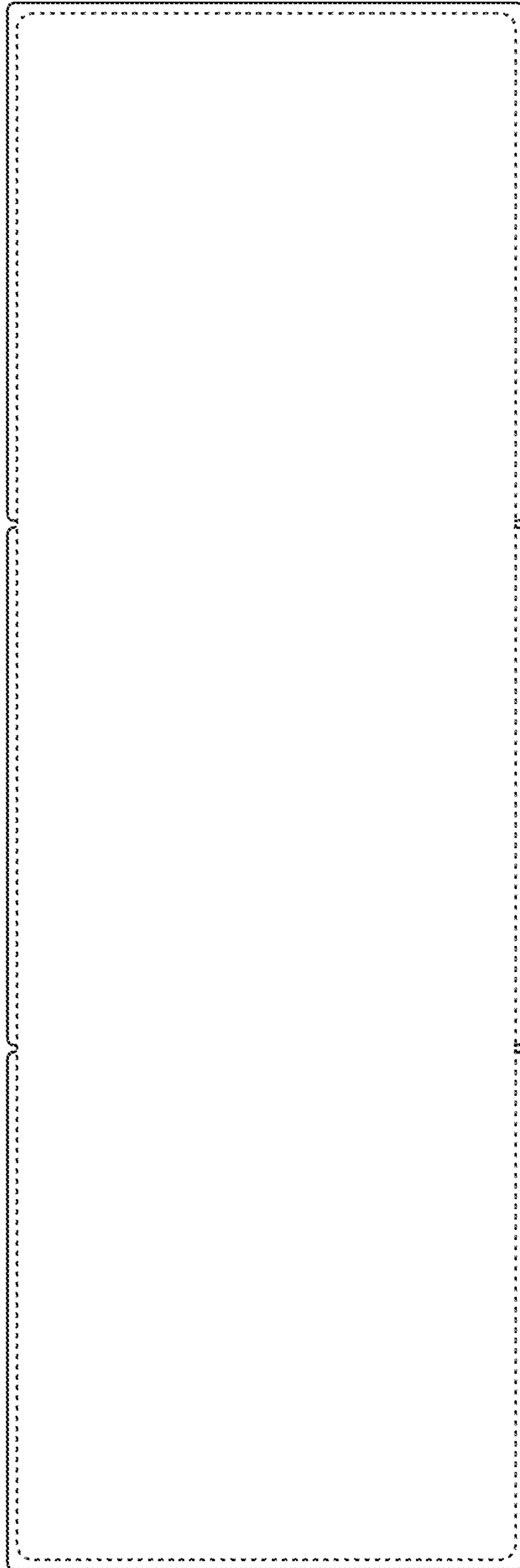
**FIG. 18**



**FIG. 19**



**FIG. 20**



**FIG. 21**