



US00D707492S

(12) **United States Design Patent**
George et al.

(10) **Patent No.:** **US D707,492 S**
(45) **Date of Patent:** **** Jun. 24, 2014**

(54) **BEVERAGE CONTAINER**

- (71) Applicant: **Pacific Market International, LLC**,
Seattle, WA (US)
- (72) Inventors: **Sarah Danger George**, Vashon, WA
(US); **Andrew C. F. Wahl**, Seattle, WA
(US)
- (73) Assignee: **Pacific Market International, LLC**,
Seattle, WA (US)
- (**) Term: **14 Years**
- (21) Appl. No.: **29/465,498**
- (22) Filed: **Aug. 28, 2013**

| | | | | |
|----------------|--------|----------------|-------|----------|
| D608,640 S * | 1/2010 | Carreno | | D9/449 |
| D610,402 S * | 2/2010 | Carreno | | D7/396.2 |
| D623,473 S * | 9/2010 | Chen | | D7/510 |
| D655,580 S * | 3/2012 | Kotani | | D7/608 |
| D667,263 S | 9/2012 | Gilbert et al. | | |
| D675,059 S | 1/2013 | Carreno | | |
| D676,708 S * | 2/2013 | Lane | | D7/510 |
| 8,464,895 B2 * | 6/2013 | Gilbert et al. | | 220/703 |
| D686,870 S | 7/2013 | Young | | |

* cited by examiner

Primary Examiner — Marianne Pandozzi

(74) *Attorney, Agent, or Firm* — Davis Wright Tremaine
LLP; George C. Rondeau, Jr.

(57) **CLAIM**

The ornamental design for a beverage container, as shown and described.

DESCRIPTION

- Related U.S. Application Data**
- (62) Division of application No. 29/420,594, filed on May 10, 2012.
 - (51) **LOC (10) Cl.** **07-01**
 - (52) **U.S. Cl.**
USPC **D7/510; D7/511**
 - (58) **Field of Classification Search**
USPC D7/510, 511, 608, 392.1, 396.2, 900;
D9/503, 504, 449; 220/715, 703,
220/254.9, 262
See application file for complete search history.

FIG. 1 is a top front perspective view of a beverage container showing our new design.
 FIG. 2 is a right side elevational view thereof.
 FIG. 3 is a front elevational view thereof.
 FIG. 4 is a left side elevational view thereof
 FIG. 5 is a rear elevational view thereof.
 FIG. 6 is a top plan view thereof.
 FIG. 7 is a bottom plan view thereof.
 FIG. 8 is a top front perspective view of a second embodiment thereof.
 FIG. 9 is a right side elevational view thereof.
 FIG. 10 is a front elevational view thereof.
 FIG. 11 is a left side elevational view thereof
 FIG. 12 is a rear elevational view thereof.
 FIG. 13 is a top plan view thereof; and,
 FIG. 14 is a bottom plan view thereof.
 The broken lines represent portions of the beverage container that form no part of the claim.

(56) **References Cited**

U.S. PATENT DOCUMENTS

| | | | | |
|---------------|--------|-----------------|-------|---------|
| 5,310,081 A * | 5/1994 | McCabe | | 220/715 |
| D455,611 S * | 4/2002 | Kitamura et al. | | D7/608 |
| D587,969 S * | 3/2009 | Gilbert | | D7/510 |
| D588,411 S * | 3/2009 | Watanabe | | D7/510 |
| D592,012 S * | 5/2009 | Carreno | | D7/510 |
| D596,460 S * | 7/2009 | Nezu | | D7/510 |

1 Claim, 12 Drawing Sheets

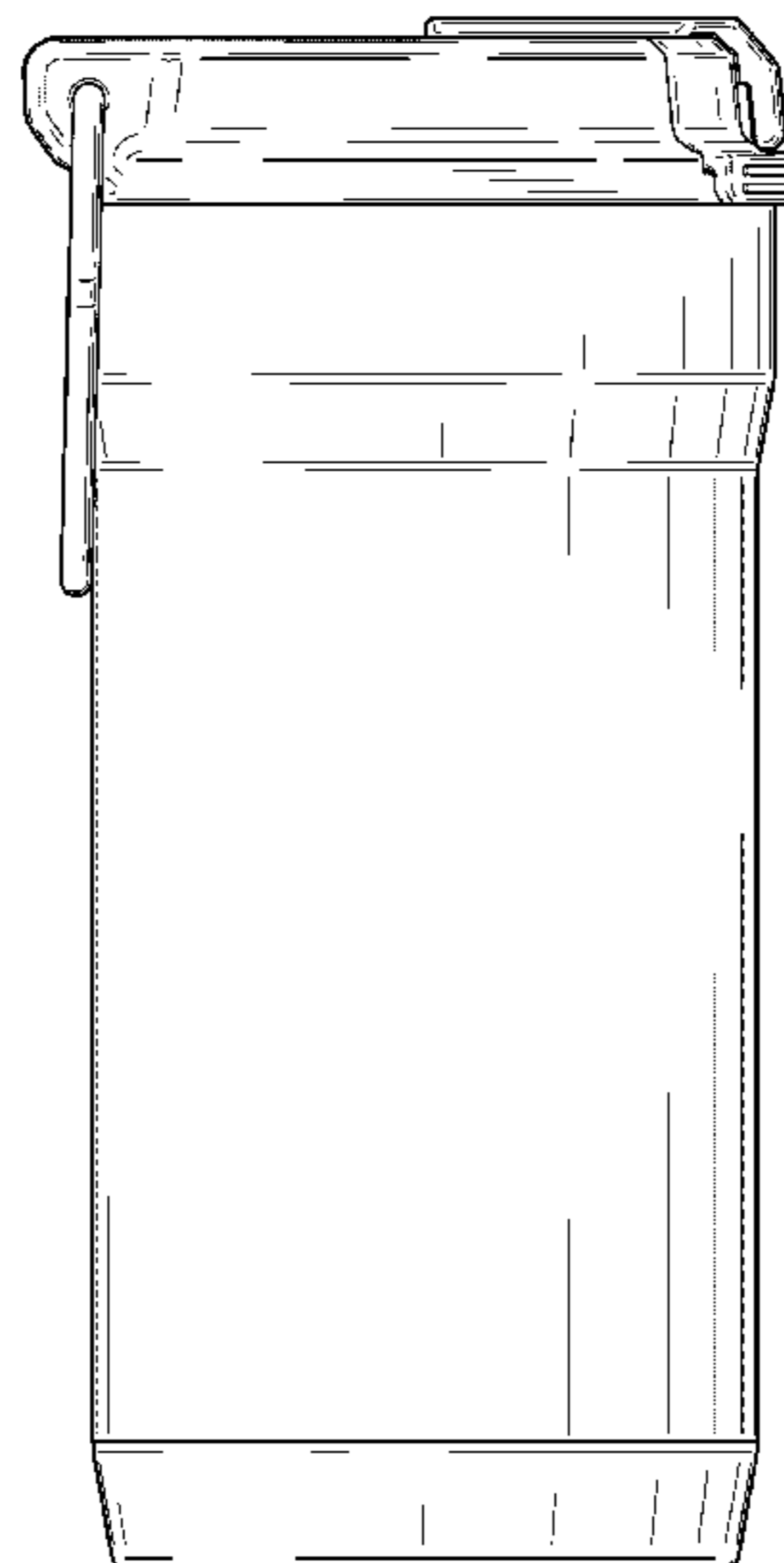
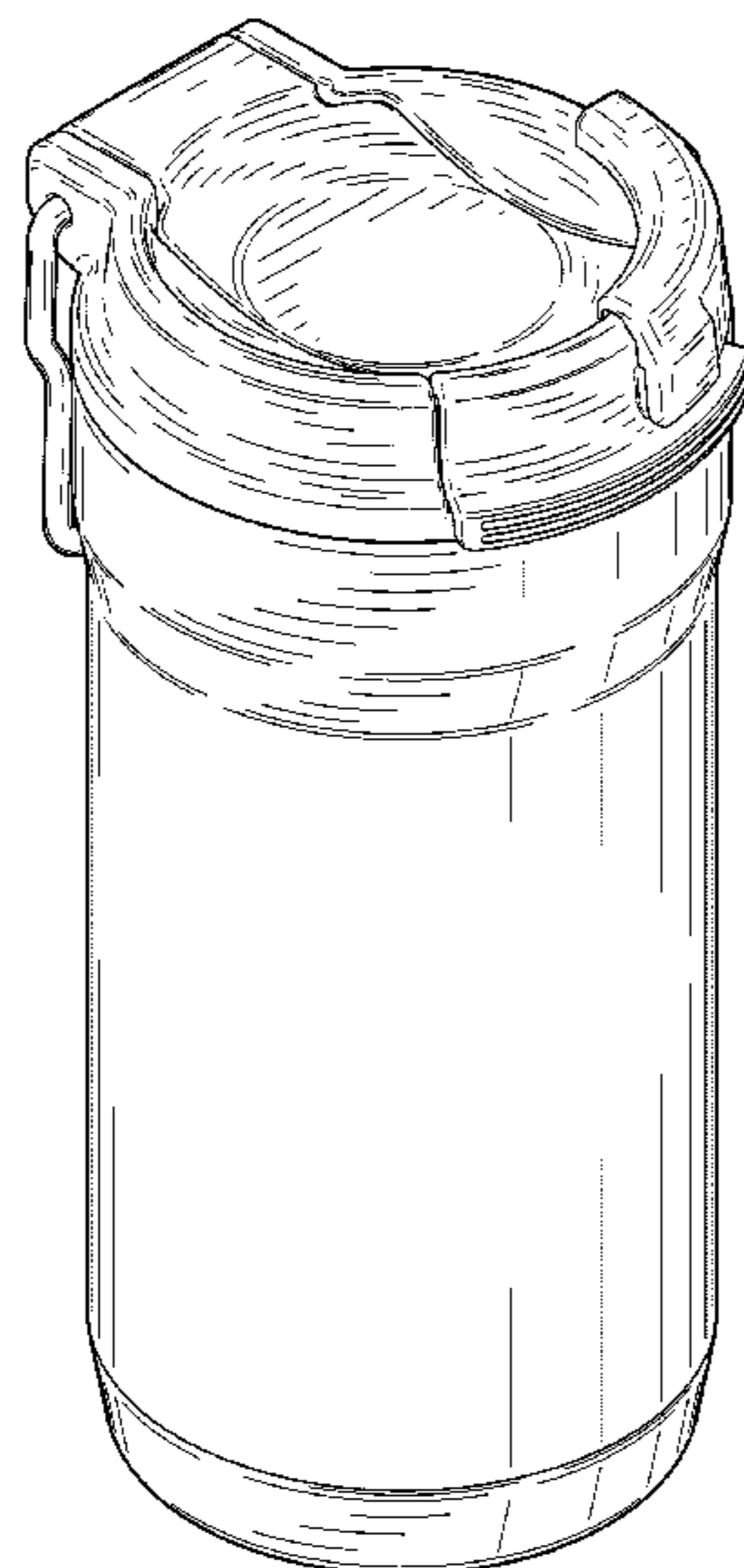

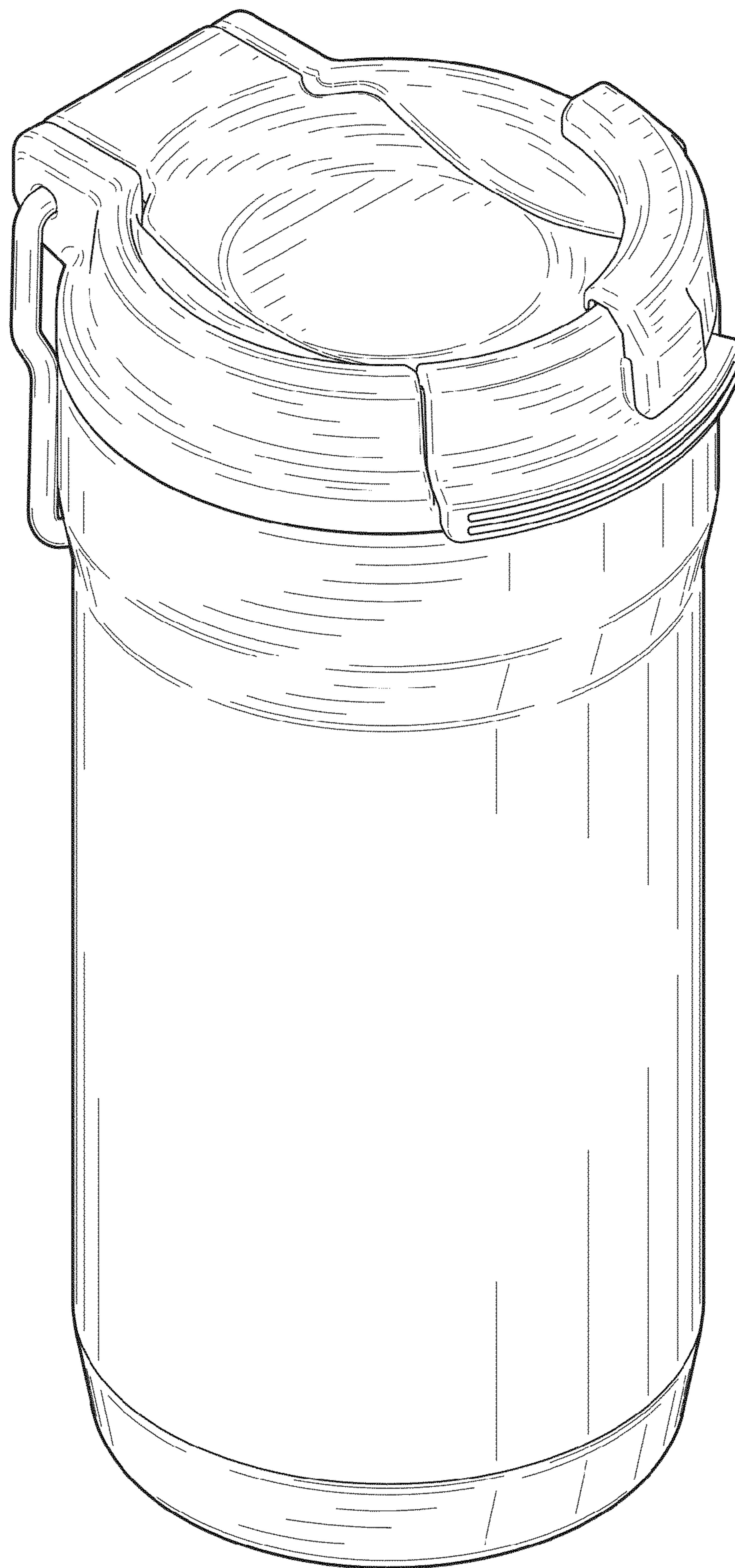

FIG. 1

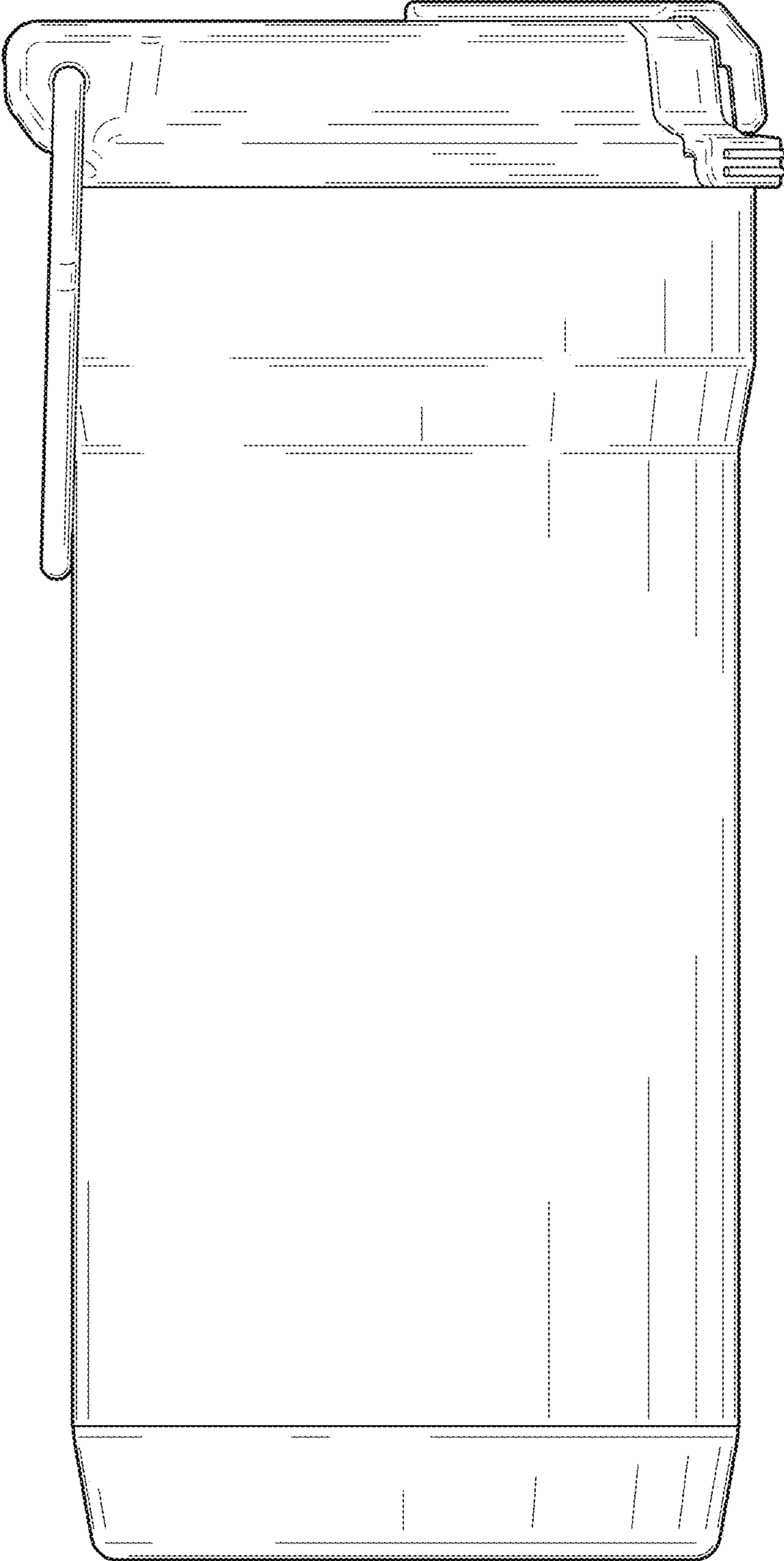

FIG. 2

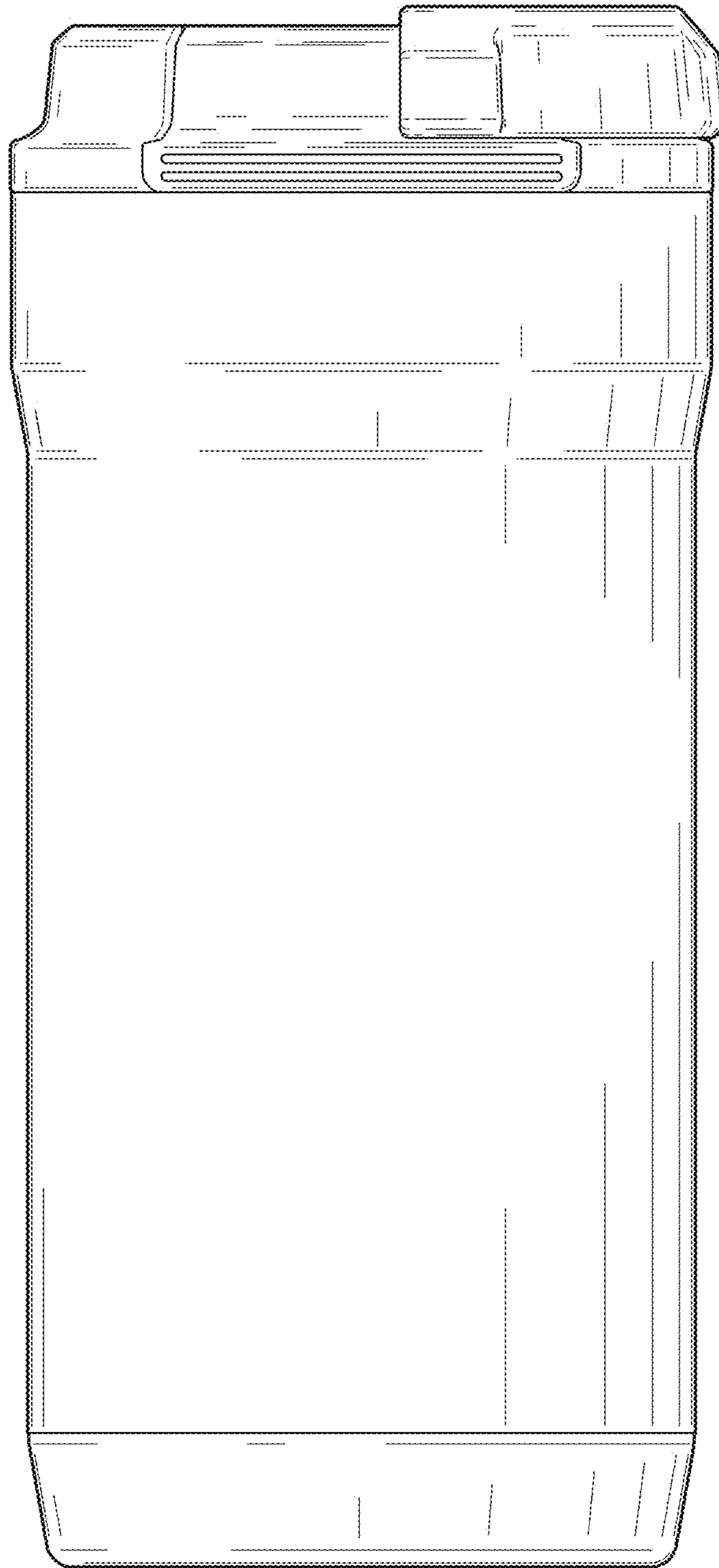

FIG. 3

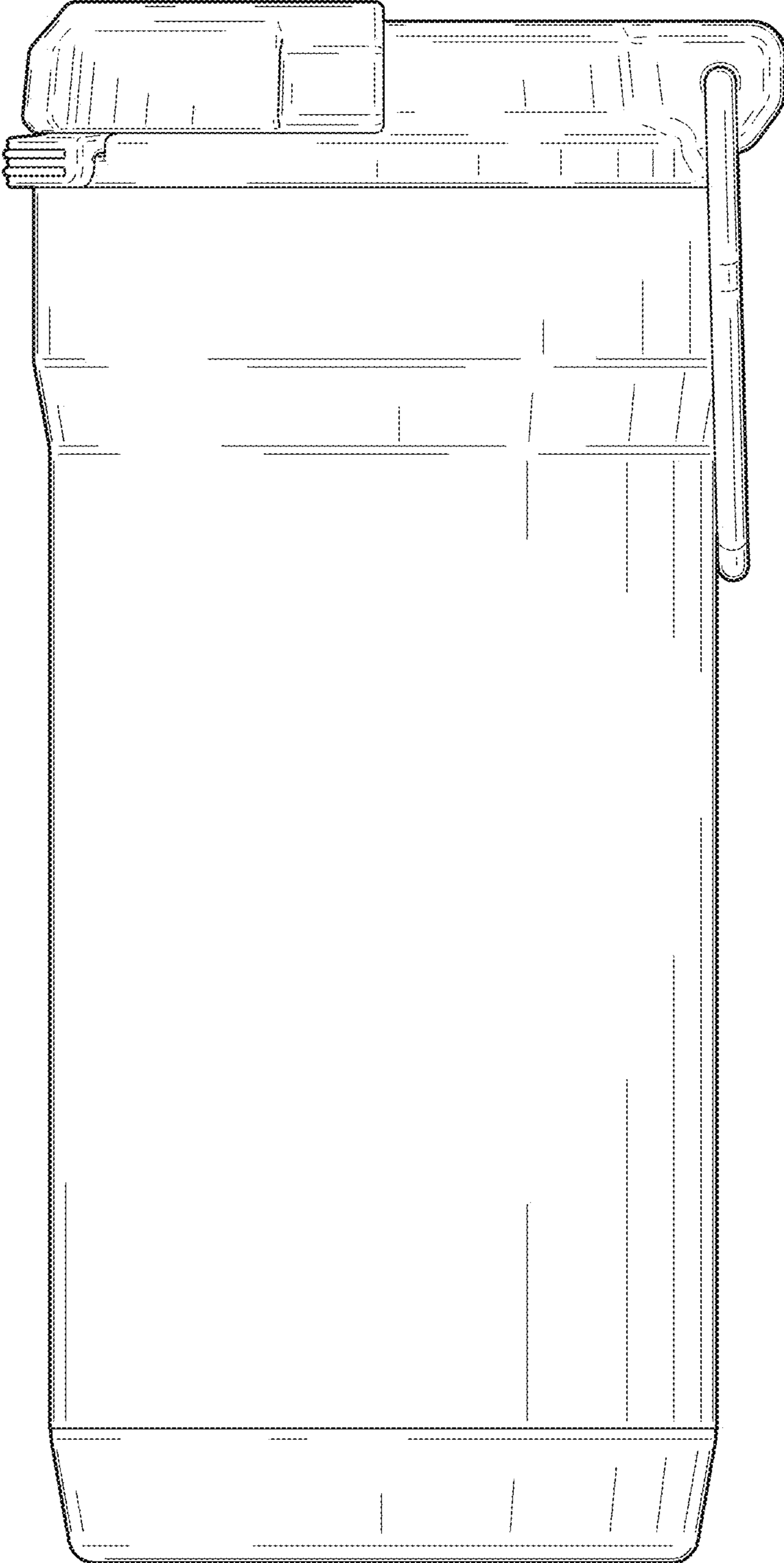

FIG. 4

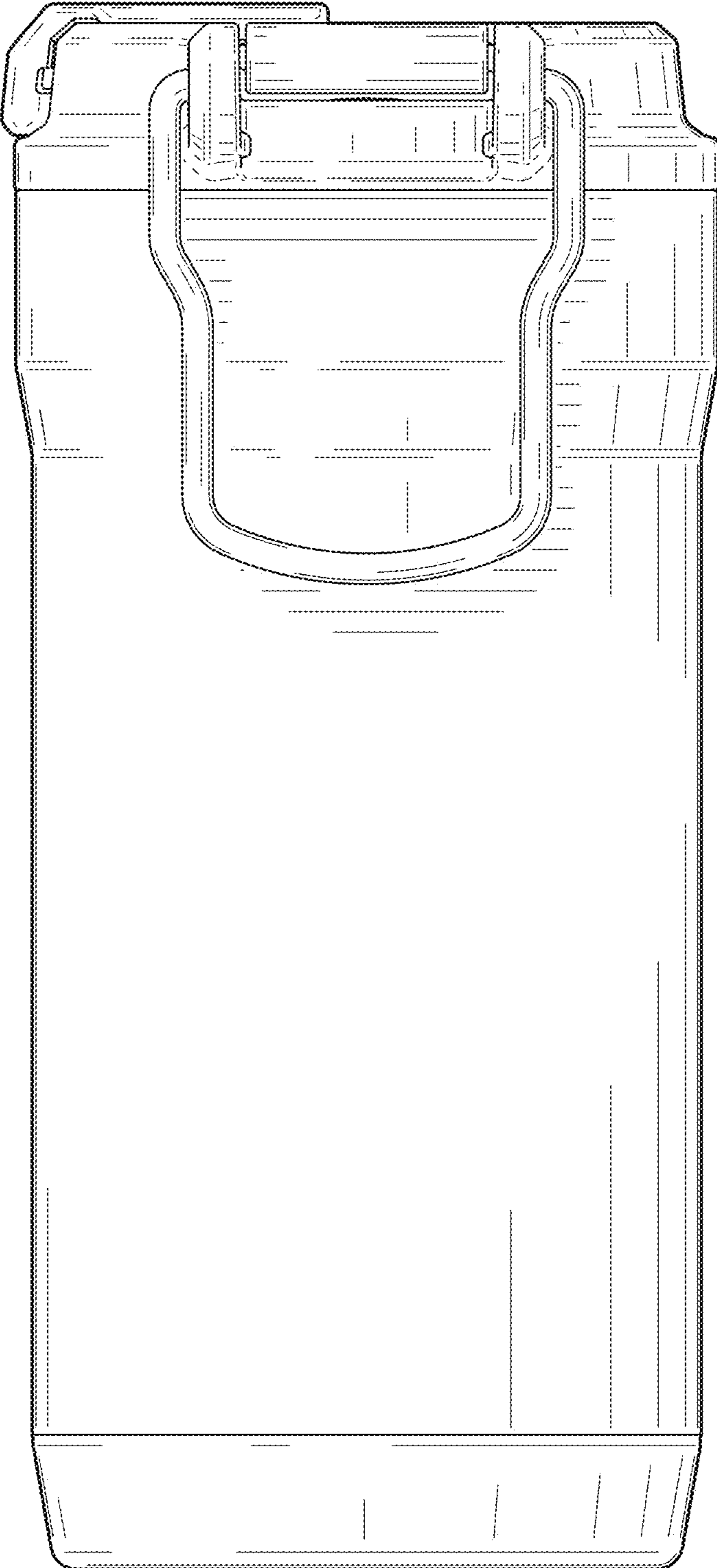

FIG. 5

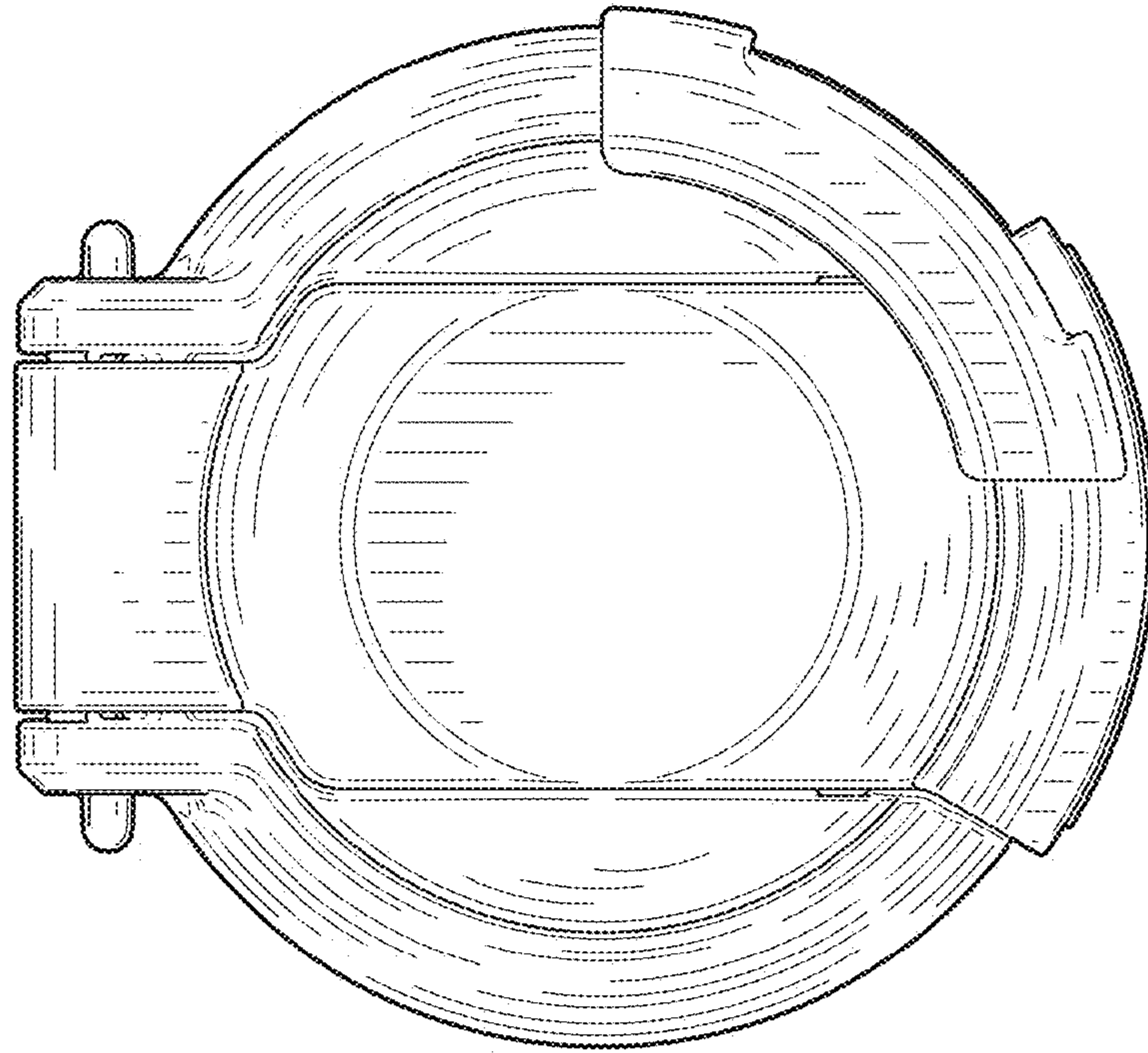

FIG. 6

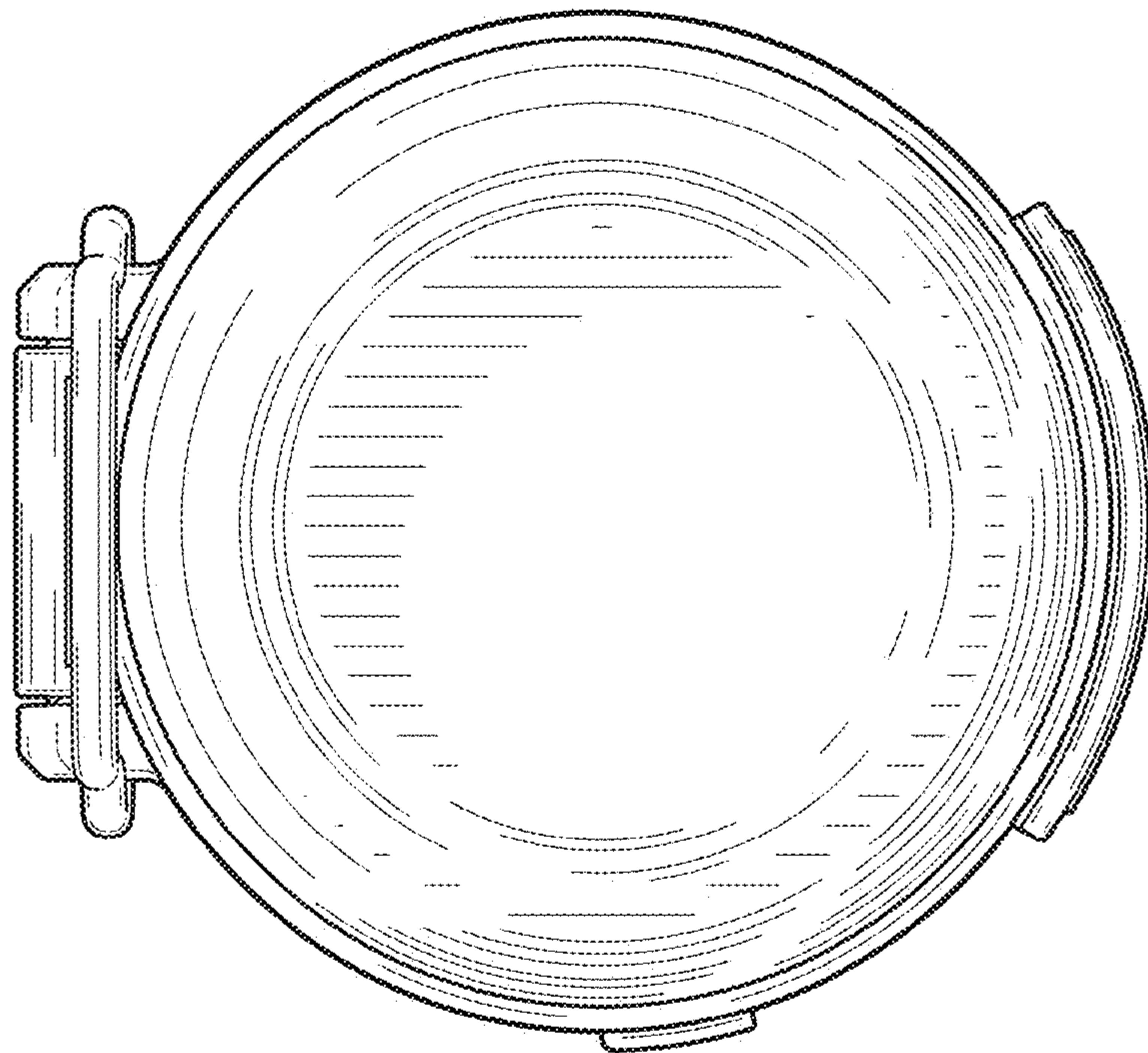

FIG. 7

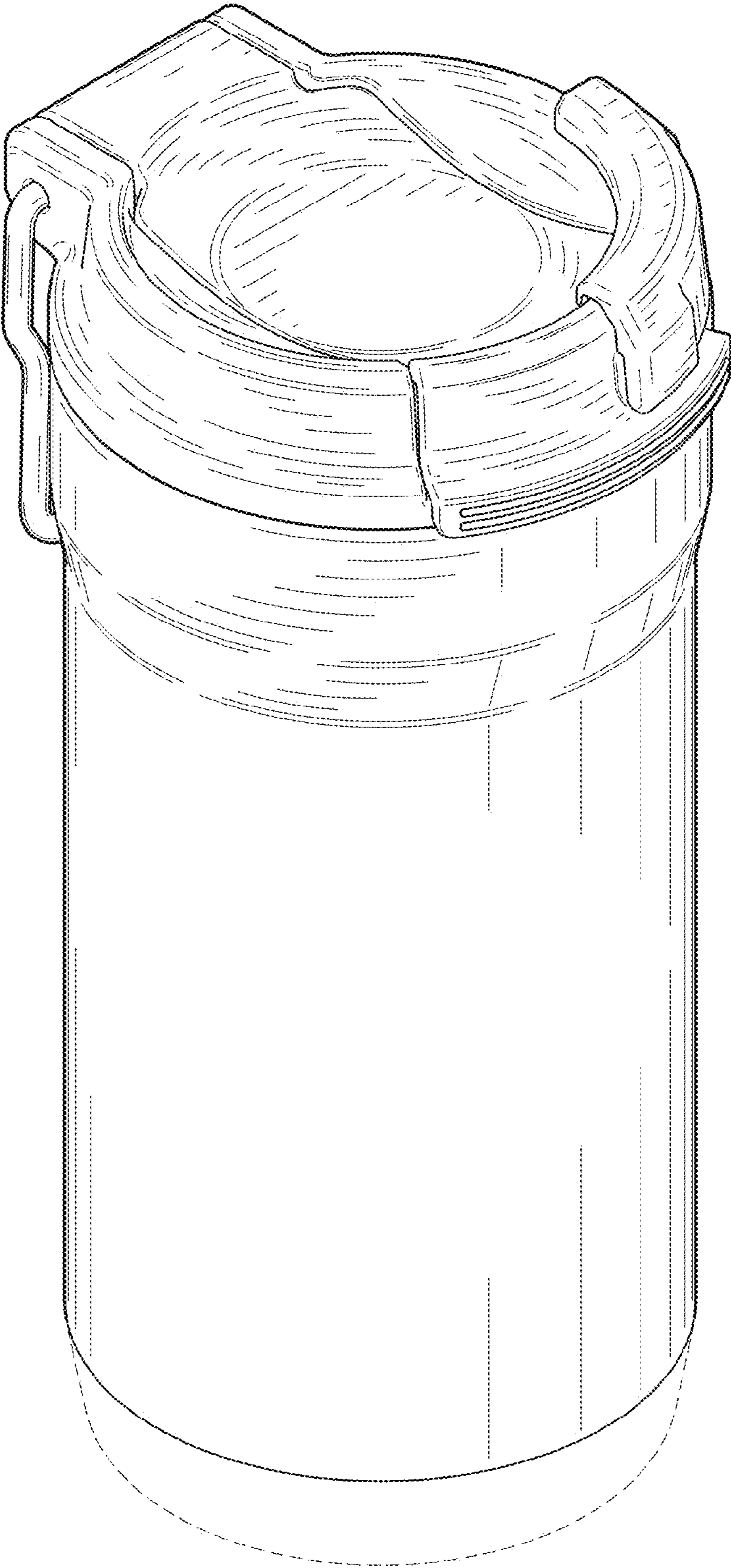

FIG. 8

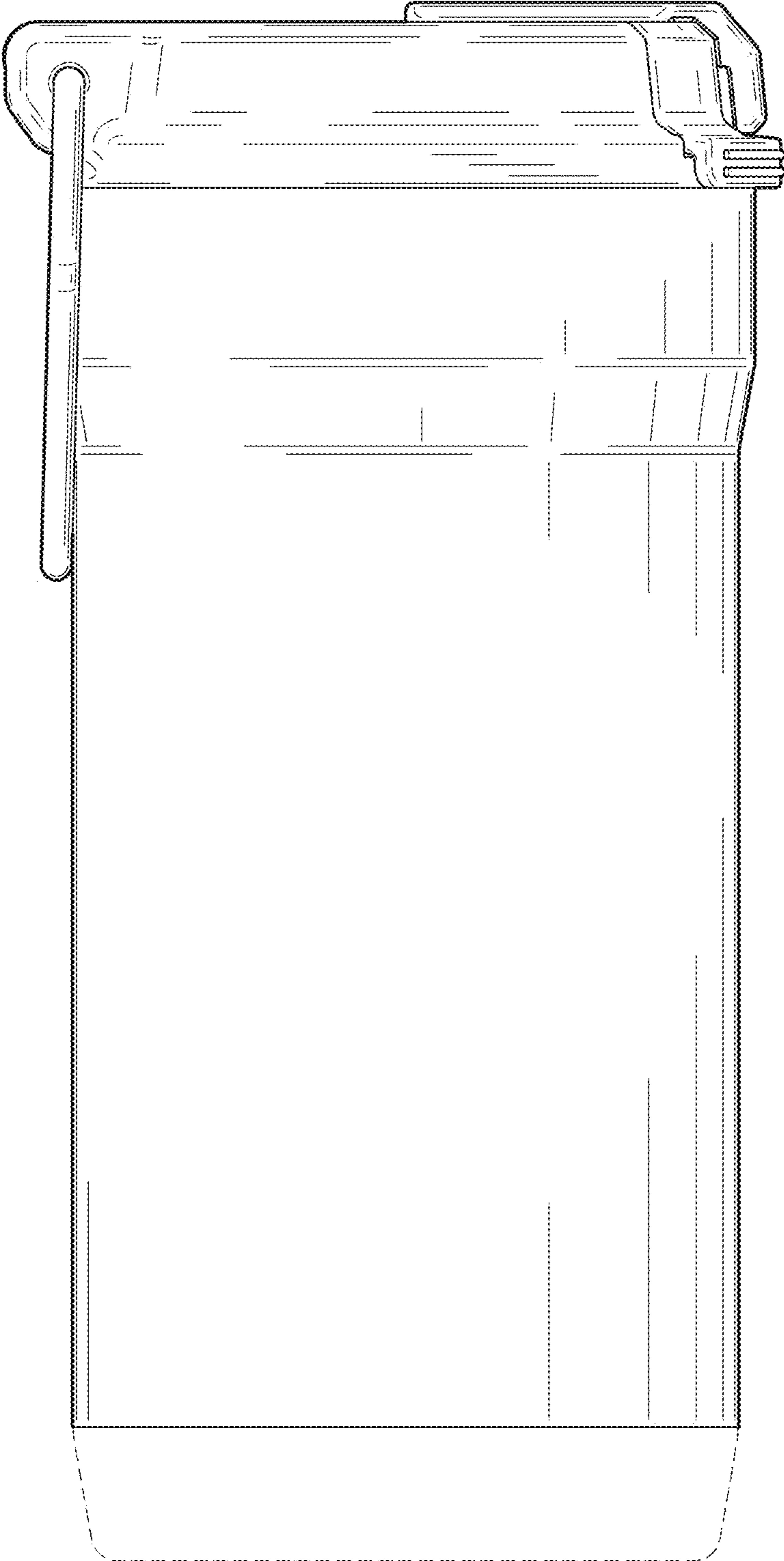

FIG. 9

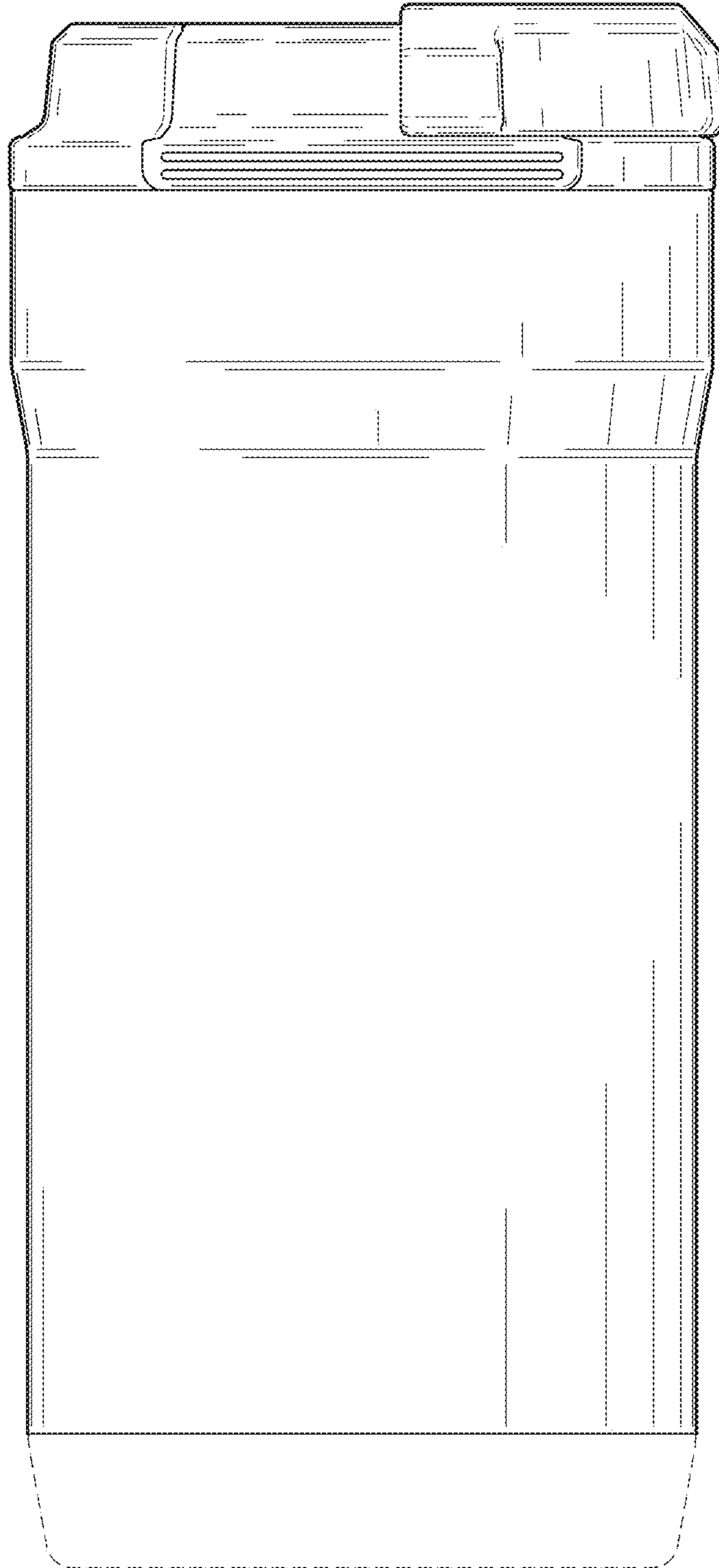

FIG.10

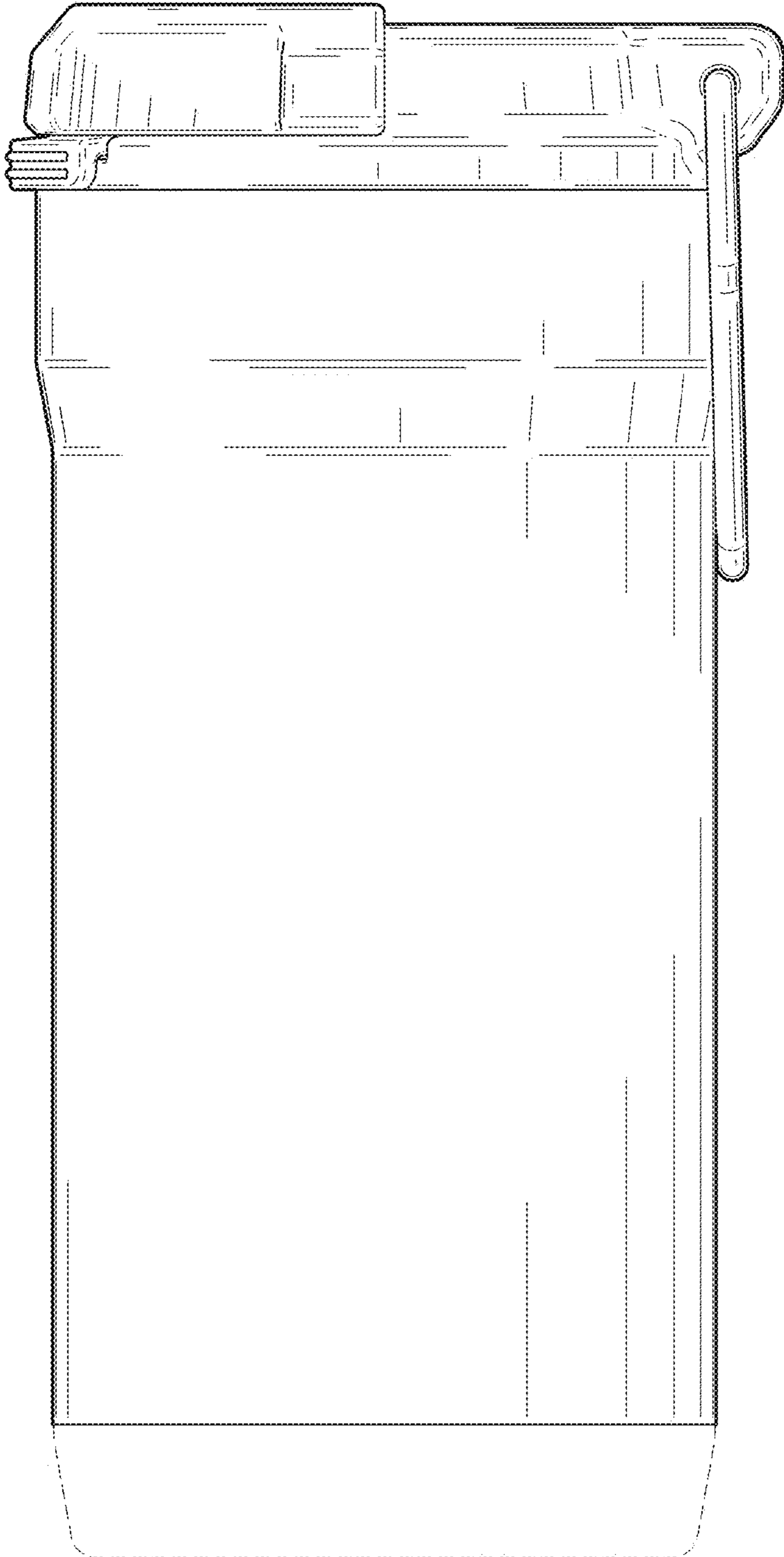

FIG.11

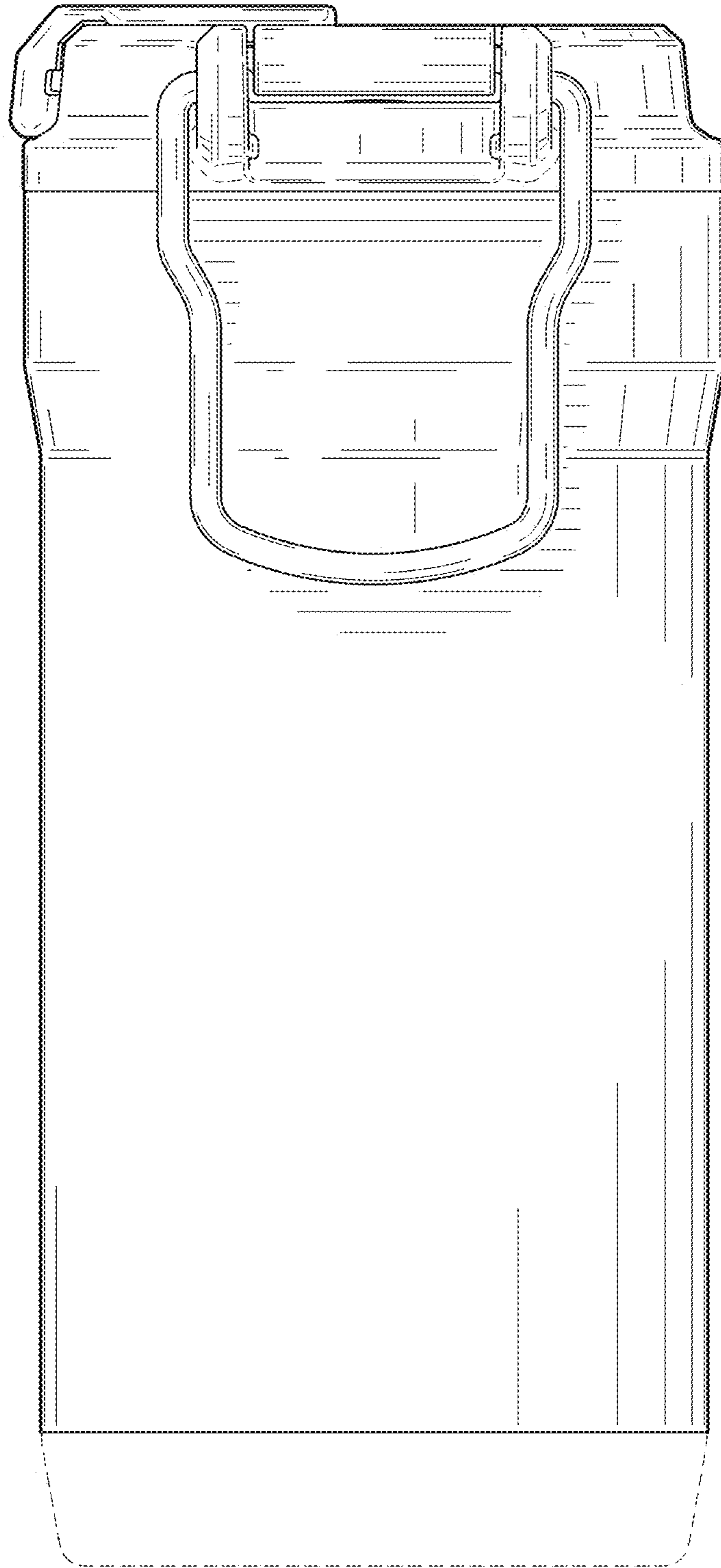

FIG.12

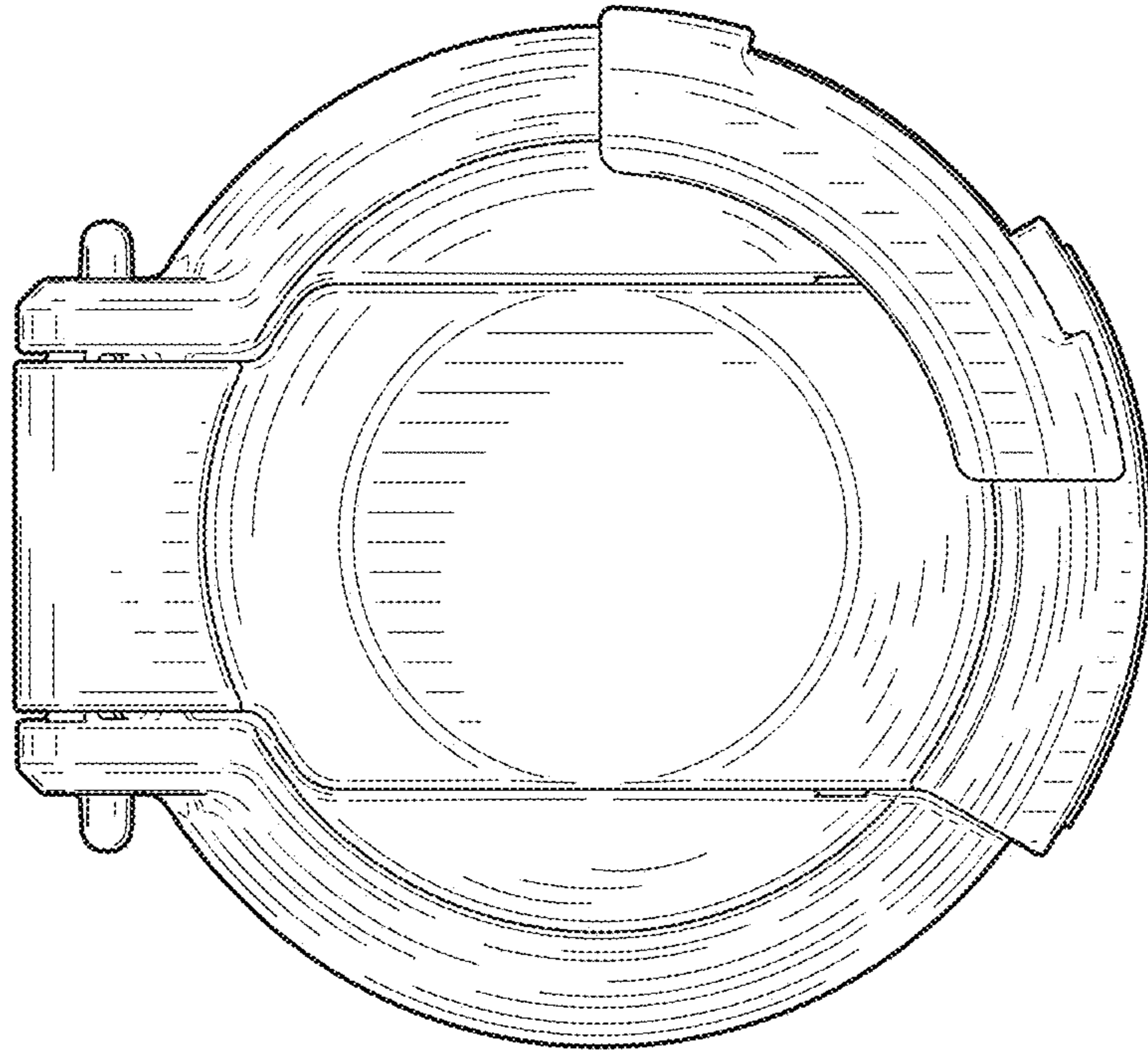

FIG. 13

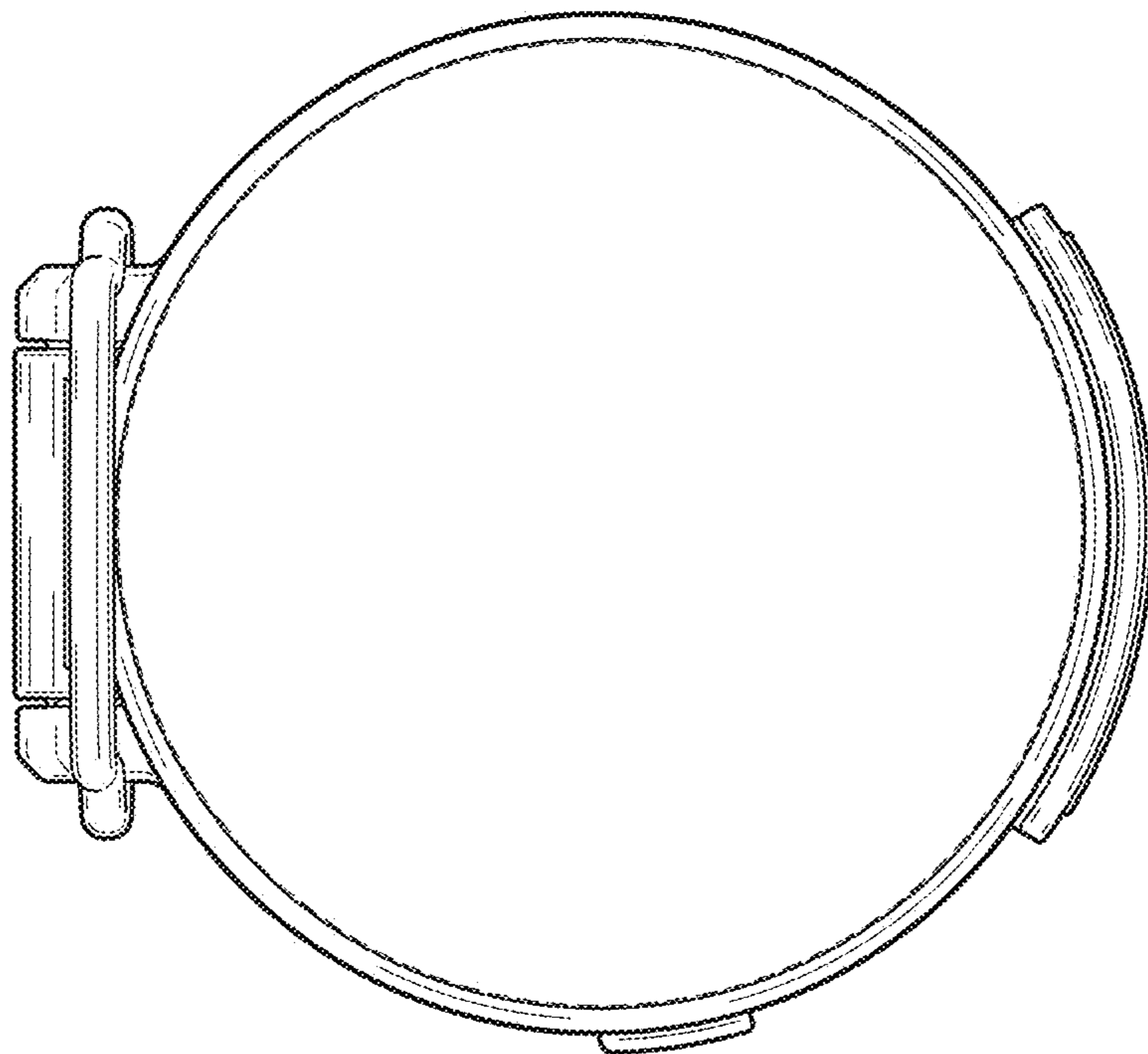

FIG. 14