



US00D707420S

(12) **United States Design Patent**
Heaton

(10) **Patent No.:** **US D707,420 S**
(45) **Date of Patent:** **** Jun. 24, 2014**

- (54) **CHOCOLATE CONFECTIONERY**
- (75) Inventor: **Nicola Heaton**, Birmingham (GB)
- (73) Assignee: **Cadbury UK Limited** (GB)
- (**) Term: **14 Years**
- (21) Appl. No.: **29/391,314**
- (22) Filed: **May 6, 2011**
- (30) **Foreign Application Priority Data**

Nov. 9, 2010 (EP) 001779133-0001
 Nov. 9, 2010 (EP) 001779133-0002
 Nov. 9, 2010 (EP) 001779133-0003
 Nov. 9, 2010 (EP) 001779133-0004
 Nov. 9, 2010 (EP) 001779133-0005

- (51) **LOC (10) Cl.** **01-01**
- (52) **U.S. Cl.**
USPC **D1/127**
- (58) **Field of Classification Search**
USPC D1/100–130, 199; D24/101, 104;
D13/100; 426/5, 76, 87, 92, 103, 108,
426/144, 282, 549, 660; D28/8.1; 424/467
See application file for complete search history.

- (56) **References Cited**
U.S. PATENT DOCUMENTS
- | | | | | |
|--------------|---------|--------------------|-------|---------|
| D125,110 S * | 2/1941 | Manischewitz | | D1/128 |
| D254,338 S * | 3/1980 | Miller et al. | | D1/106 |
| D267,122 S * | 11/1982 | Scotton et al. | | D24/101 |
| D269,711 S * | 7/1983 | Tovey | | D24/101 |
| D286,449 S * | 10/1986 | Tovey | | D24/101 |
| D287,019 S * | 12/1986 | Anderson et al. | | D15/138 |
| D345,207 S * | 3/1994 | Bennell et al. | | D24/104 |
| D405,879 S * | 2/1999 | Leonard | | D24/101 |
| D421,827 S * | 3/2000 | Doyle et al. | | D1/199 |
| D443,688 S * | 6/2001 | Holland et al. | | D24/101 |
| D520,212 S * | 5/2006 | Jackman | | D1/111 |
| D561,686 S * | 2/2008 | Saunders et al. | | D13/100 |
| D613,026 S * | 4/2010 | Fitzpatrick et al. | | D1/106 |

* cited by examiner

Primary Examiner — Cathron Brooks
Assistant Examiner — Katie Mroczka

- (74) *Attorney, Agent, or Firm* — Cantor Colburn LLP
- (57) **CLAIM**
I claim, the ornamental design for a chocolate confectionery, as shown and described.

DESCRIPTION
 FIG. 1 is a perspective view of a chocolate confectionery, showing our new design in an exemplary embodiment;
 FIG. 2 is a top plan view of the embodiment shown in FIG. 1;
 FIG. 3 is a bottom plan view of the embodiment shown in FIG. 1;
 FIG. 4 is a side perspective view of the embodiment shown in FIG. 1;
 FIG. 5 is another side perspective view of the embodiment shown in FIG. 1;
 FIG. 6 is a front perspective view of the embodiment shown in FIG. 1;
 FIG. 7 is a back perspective view of the embodiment shown in FIG. 1;
 FIG. 8 is a perspective view of a chocolate confectionery, showing our new design in another exemplary embodiment;
 FIG. 9 is a top plan view of the embodiment shown in FIG. 8;
 FIG. 10 is a bottom plan view of the embodiment shown in FIG. 8;
 FIG. 11 is a side perspective view of the embodiment shown in FIG. 8;
 FIG. 12 is another side perspective view of the embodiment shown in FIG. 8;
 FIG. 13 is a front perspective view of the embodiment shown in FIG. 8;
 FIG. 14 is a back perspective view of the embodiment shown in FIG. 8;
 FIG. 15 is a perspective view of a chocolate confectionery, showing our new design in another exemplary embodiment;
 FIG. 16 is a top plan view of the embodiment shown in FIG. 15;
 FIG. 17 is a bottom plan view of the embodiment shown in FIG. 15;
 FIG. 18 is a side perspective view of the embodiment shown in FIG. 15;
 FIG. 19 is another side perspective view of the embodiment shown in FIG. 15;
 FIG. 20 is a front perspective view of the embodiment shown in FIG. 15; and,
 FIG. 21 is a back perspective view of the embodiment shown in FIG. 15.

1 Claim, 21 Drawing Sheets

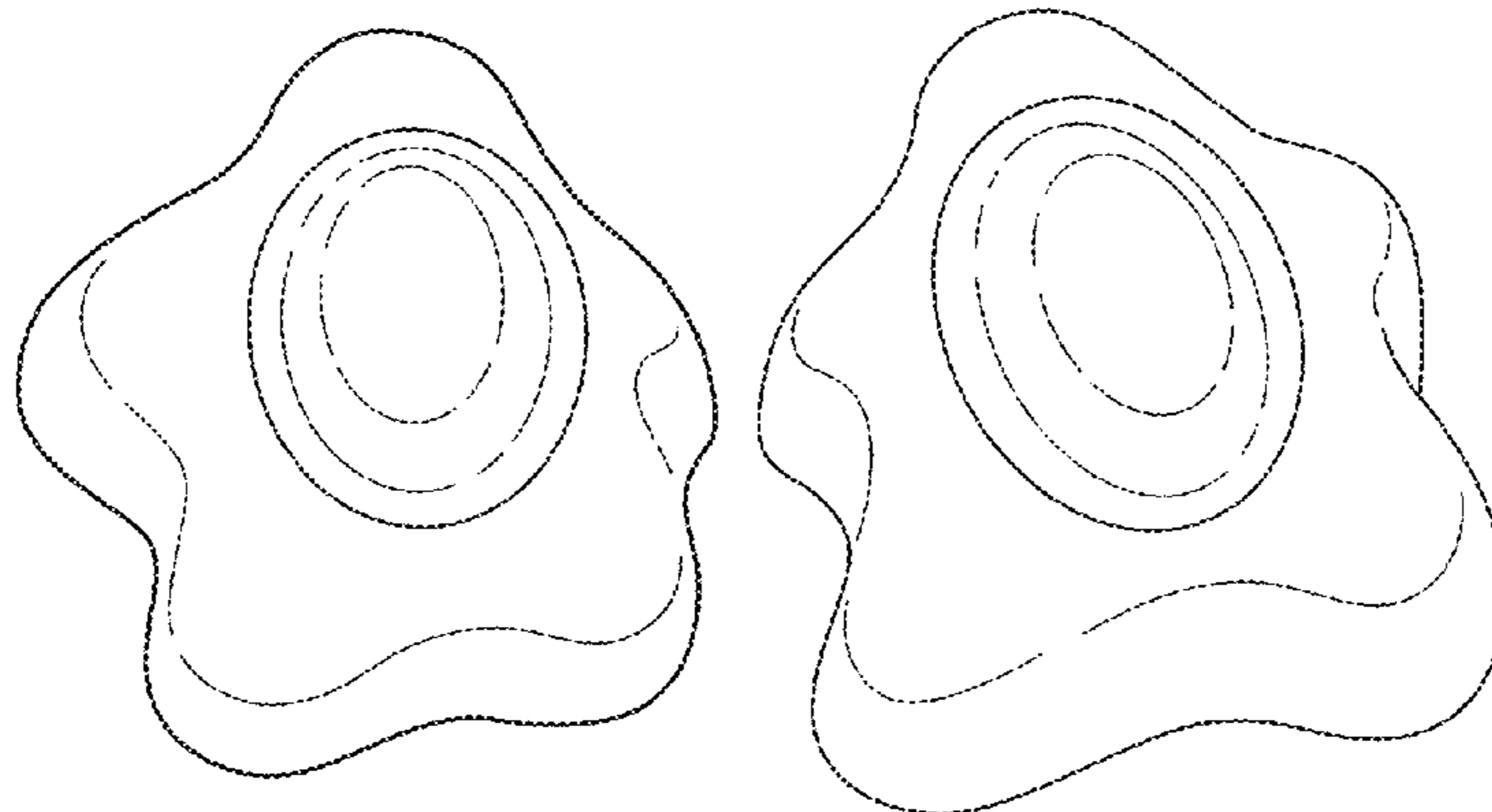

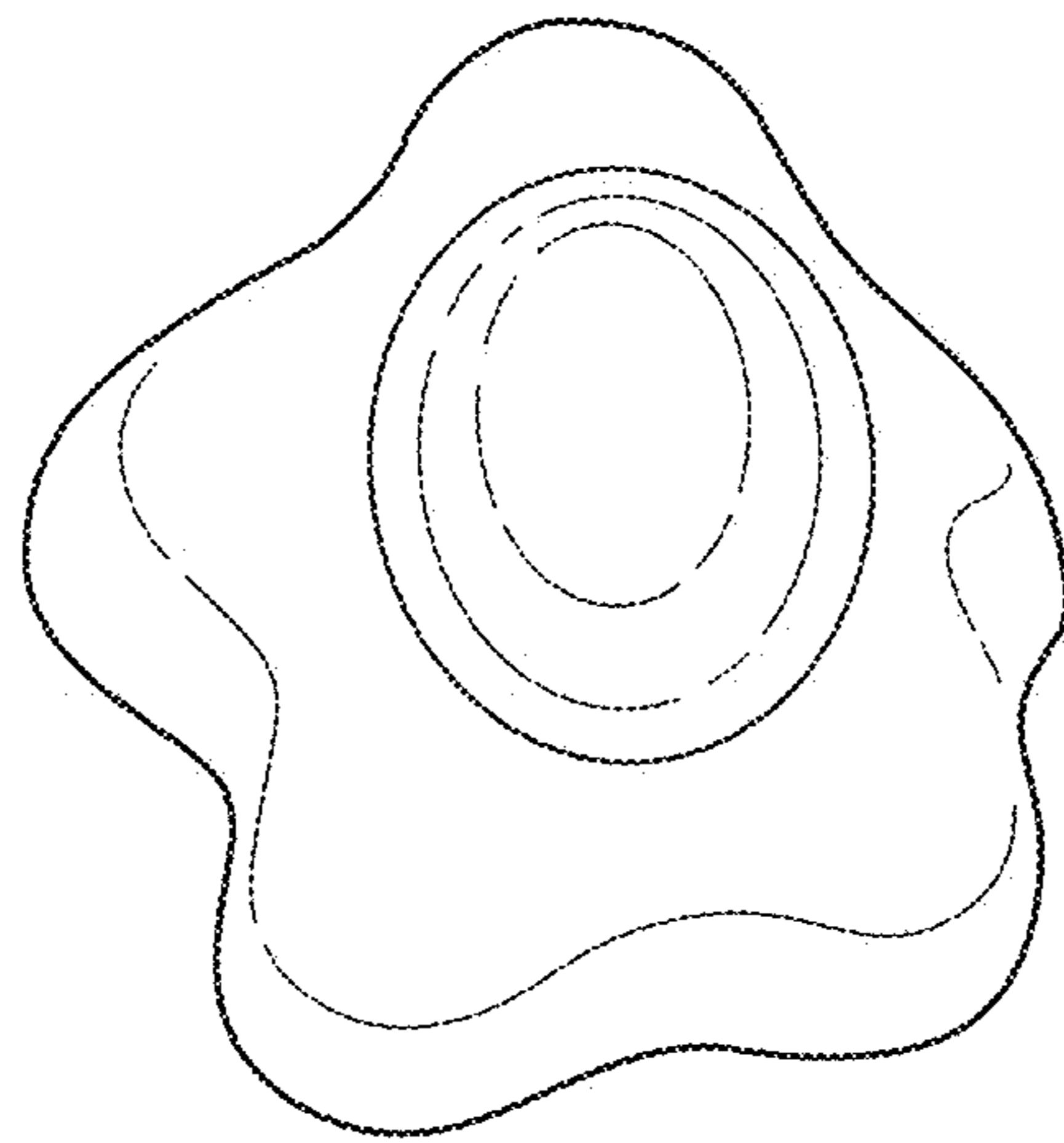

FIG. 1

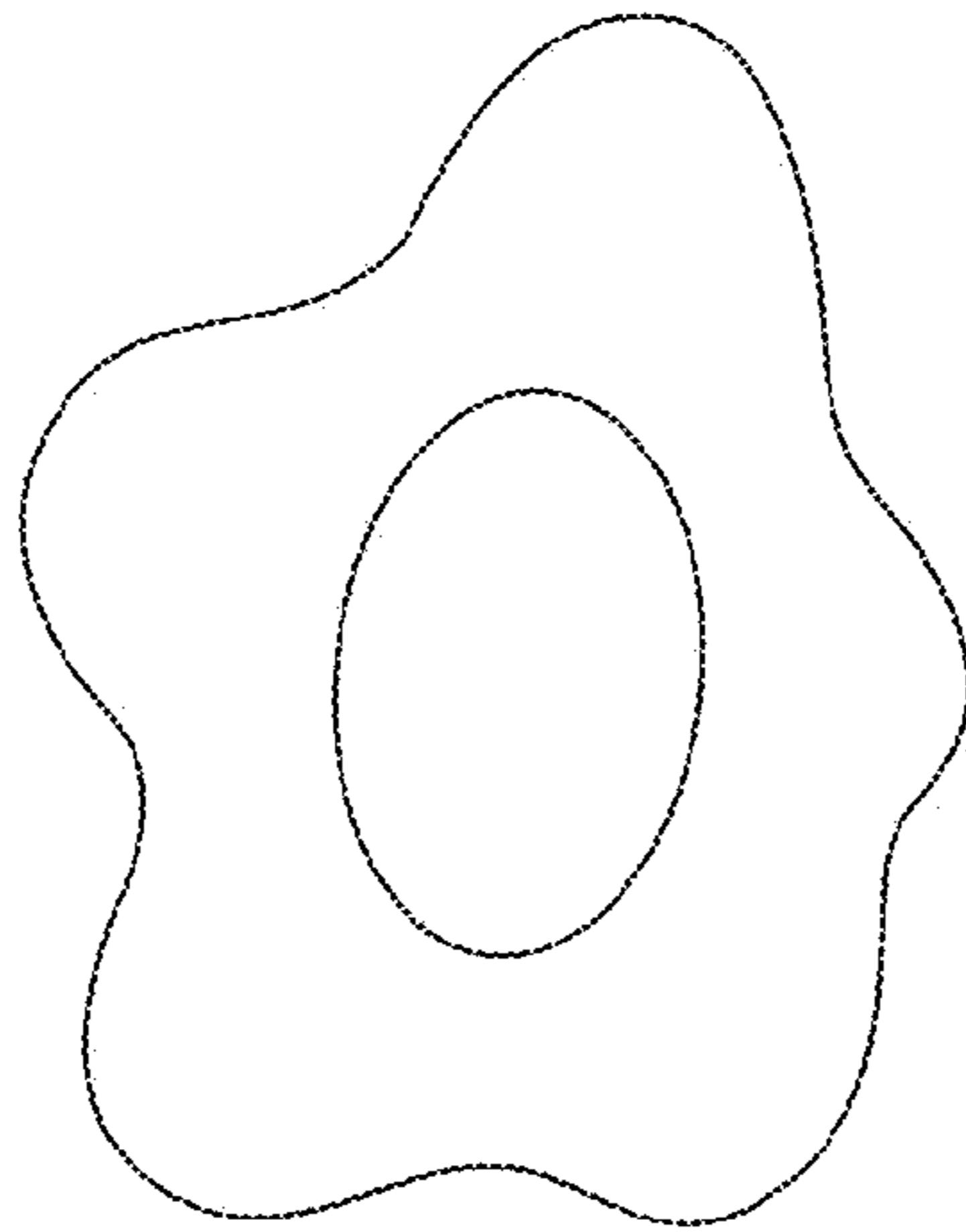

FIG. 2

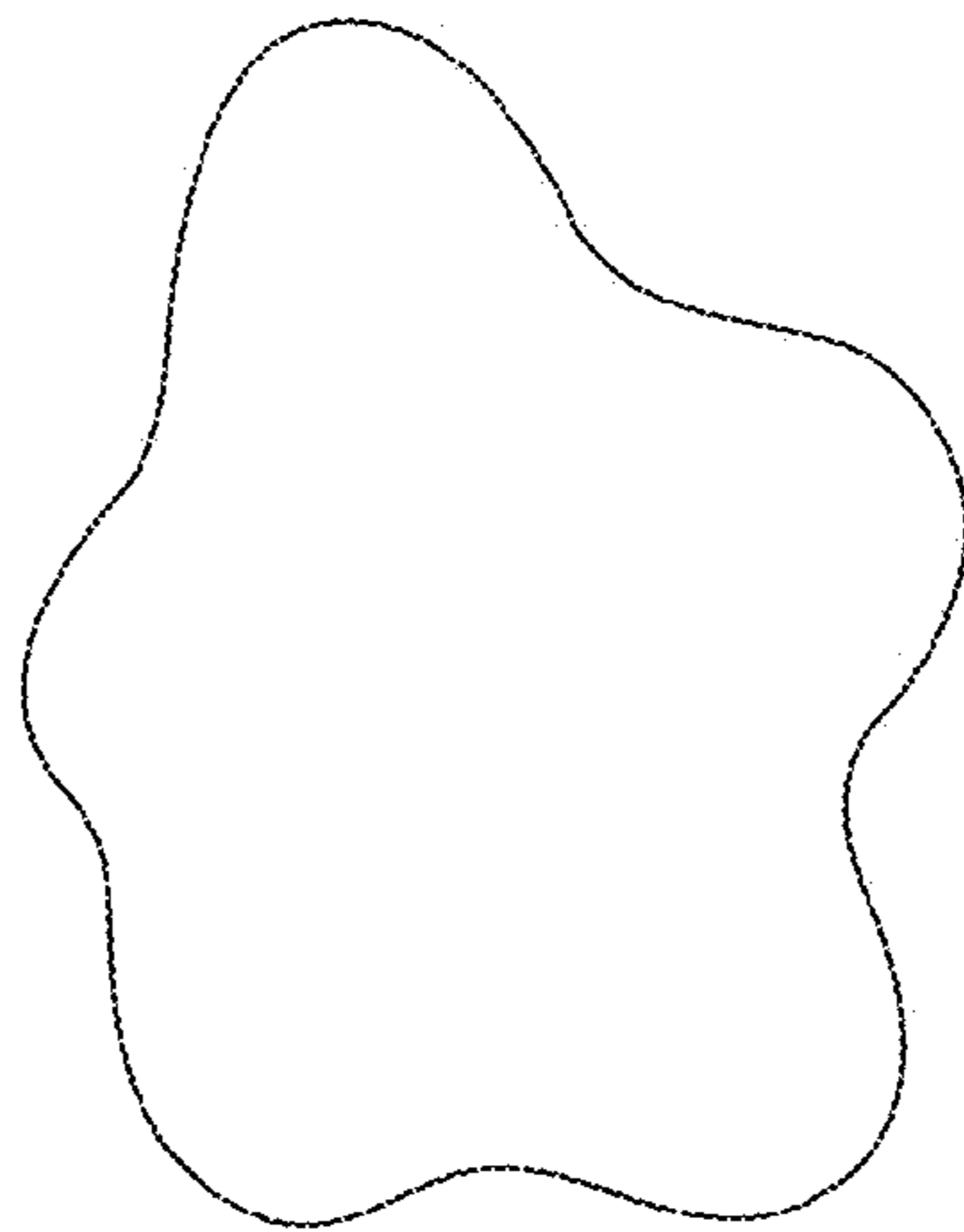

FIG. 3



FIG. 4

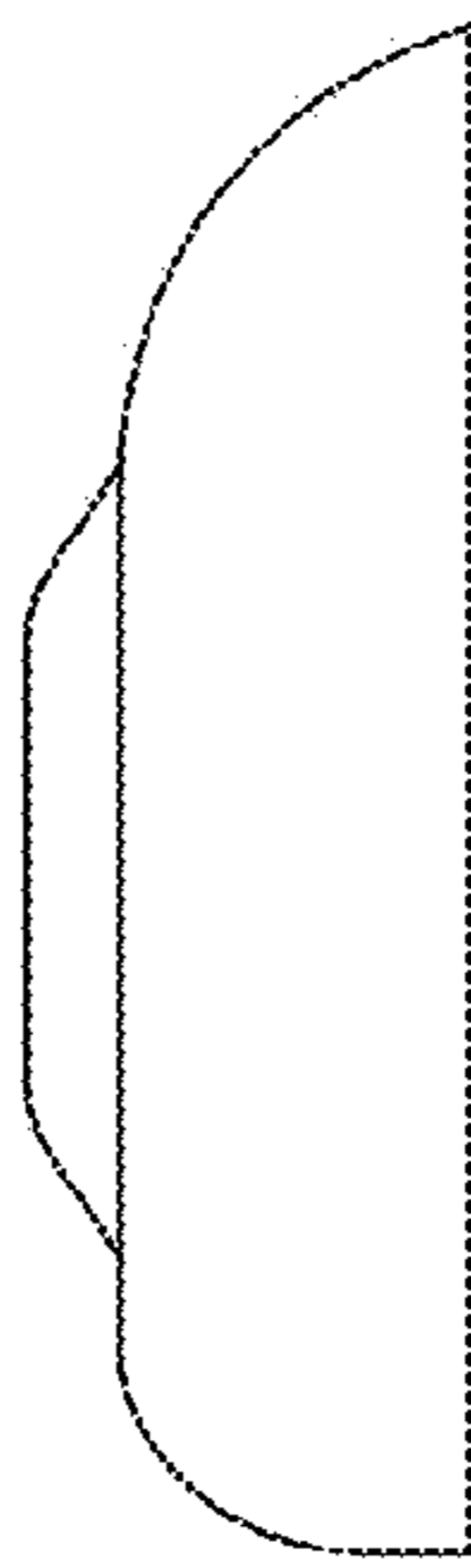

FIG. 5

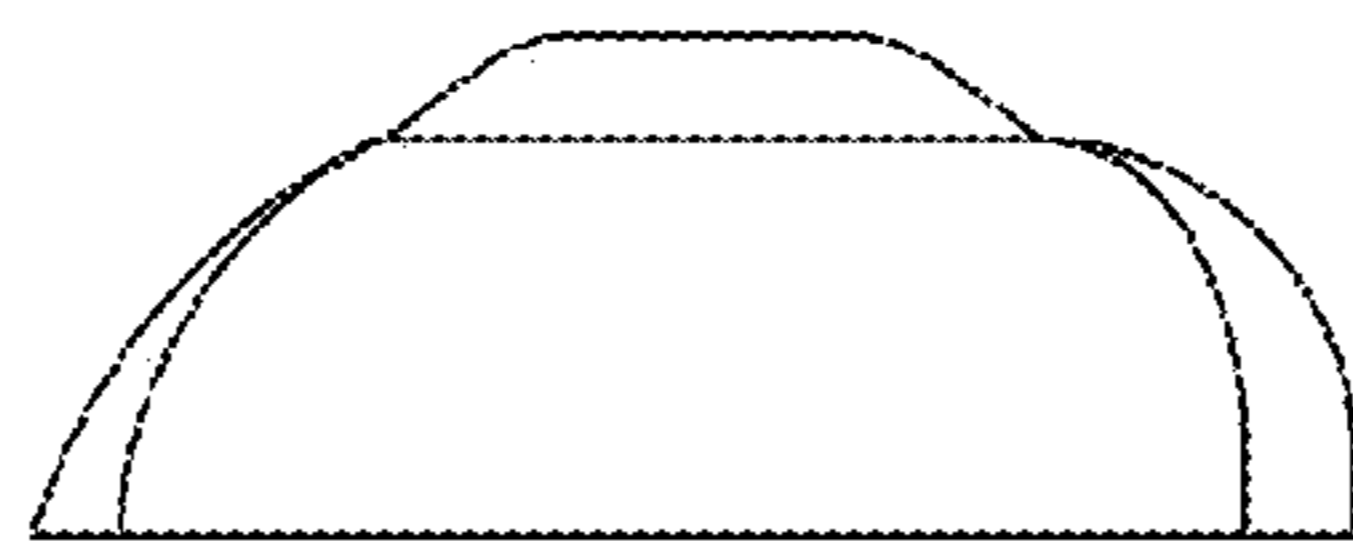

FIG. 6

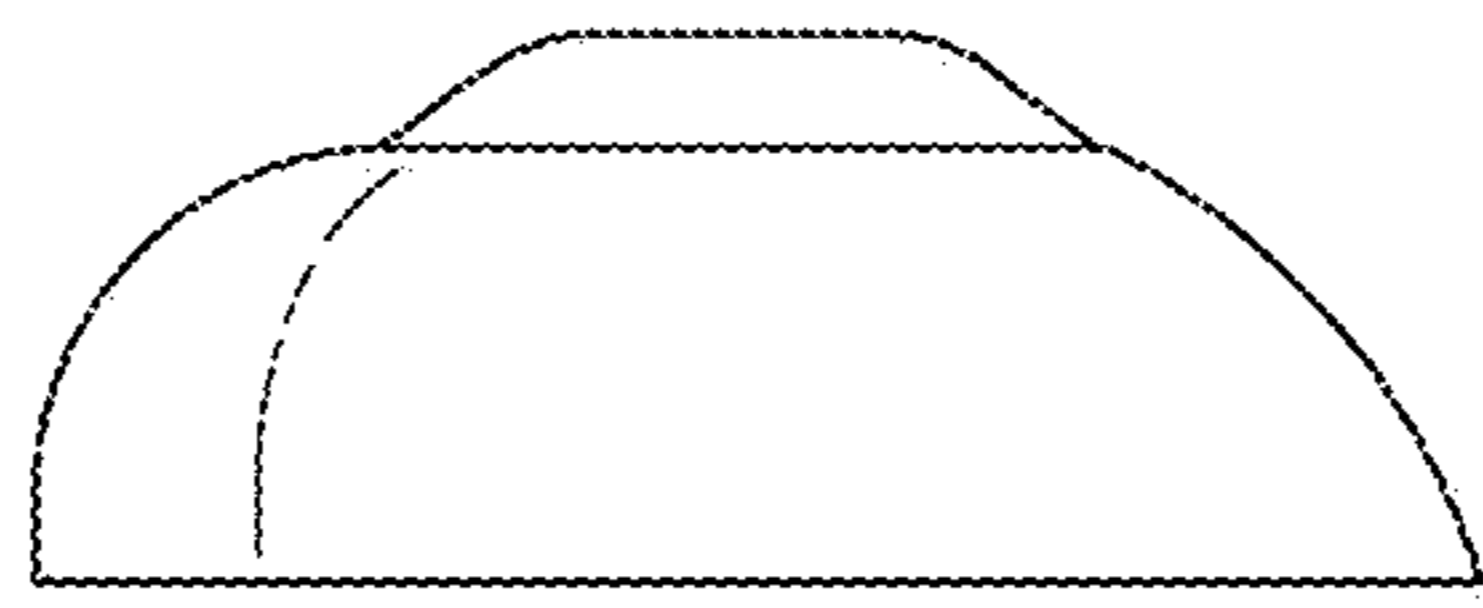

FIG. 7

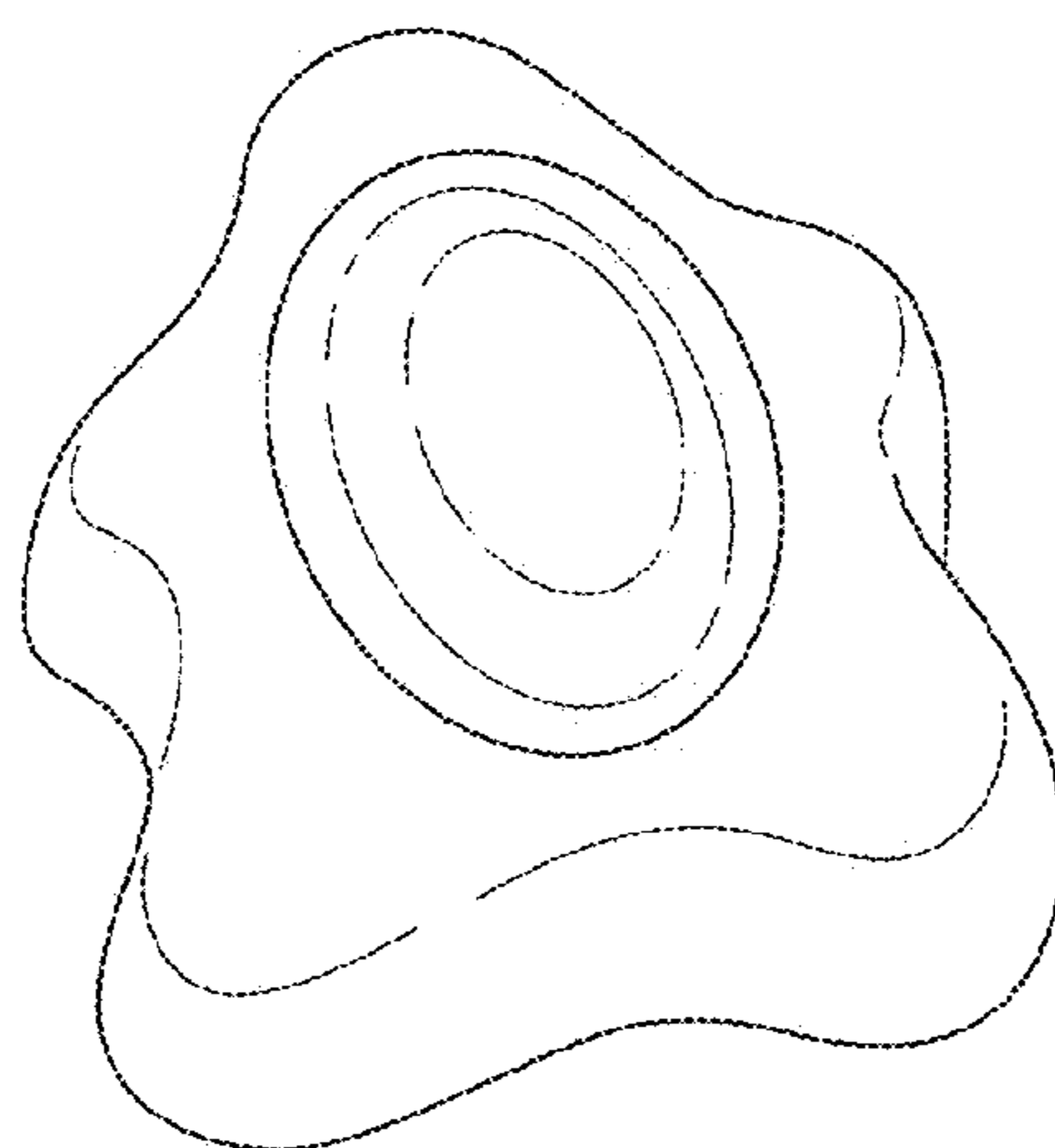

FIG. 8

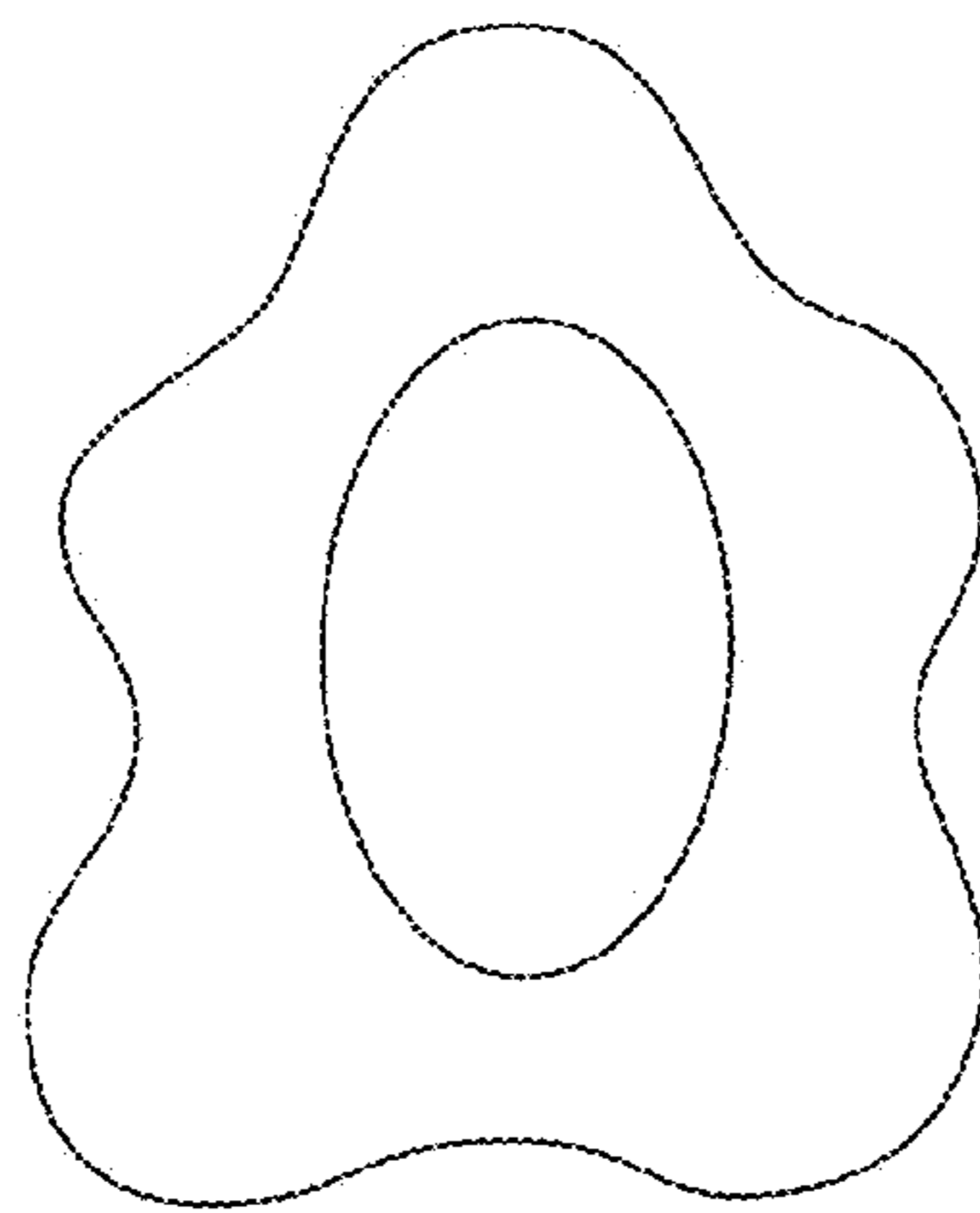

FIG. 9

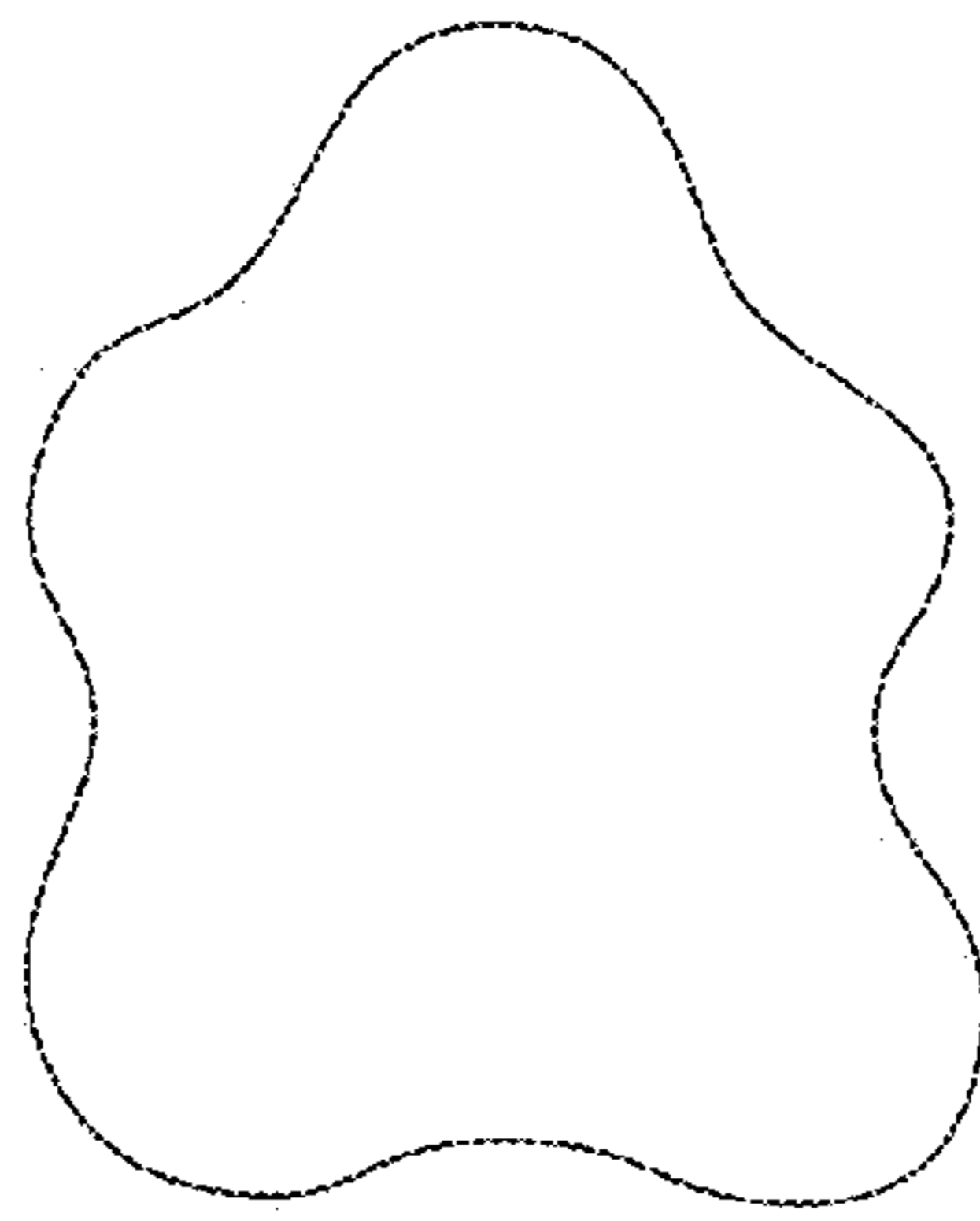

FIG. 10

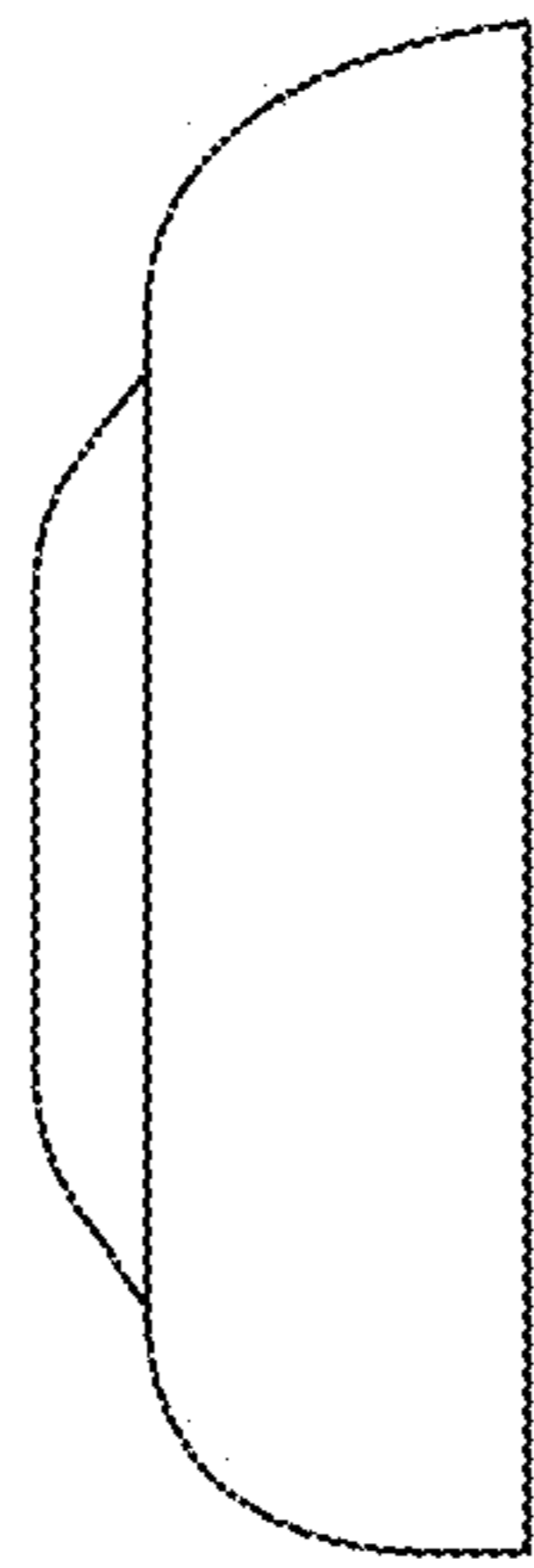

FIG. 11

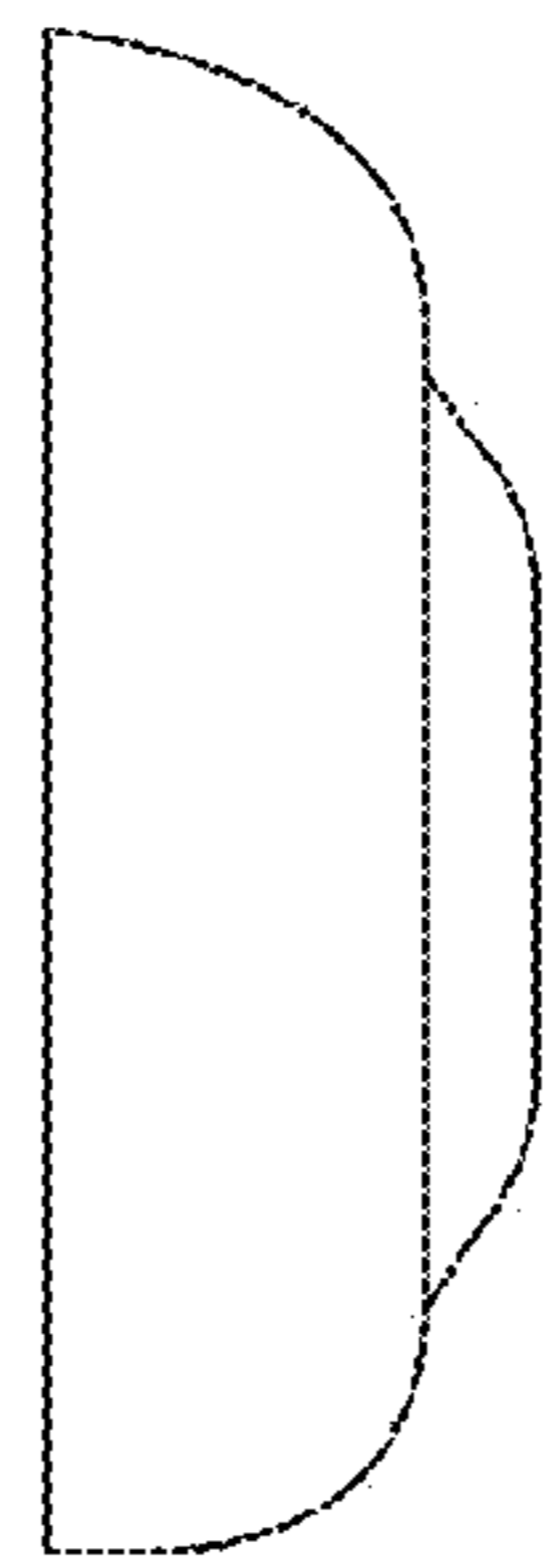

FIG. 12

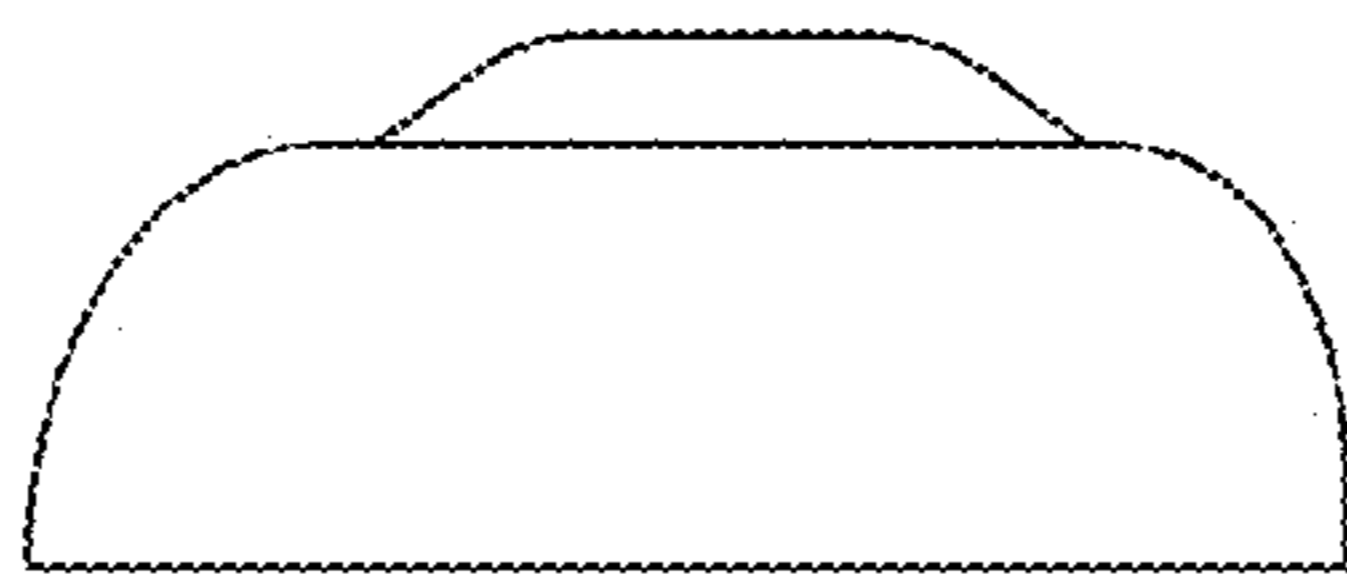

FIG. 13

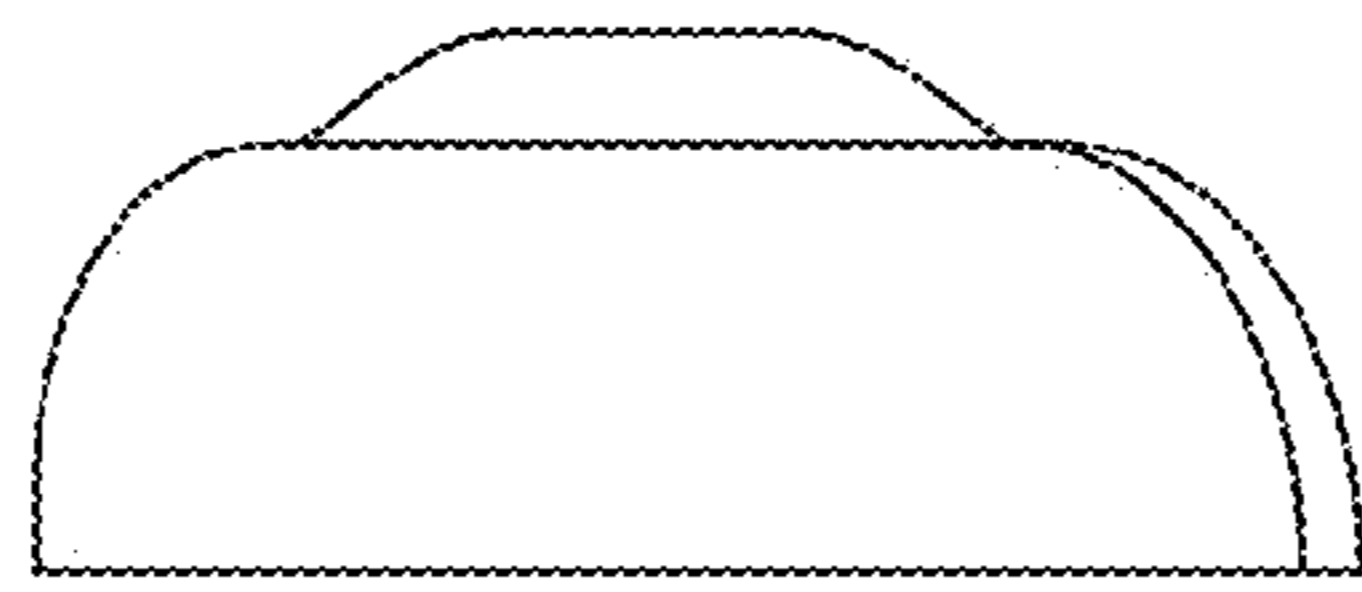

FIG. 14

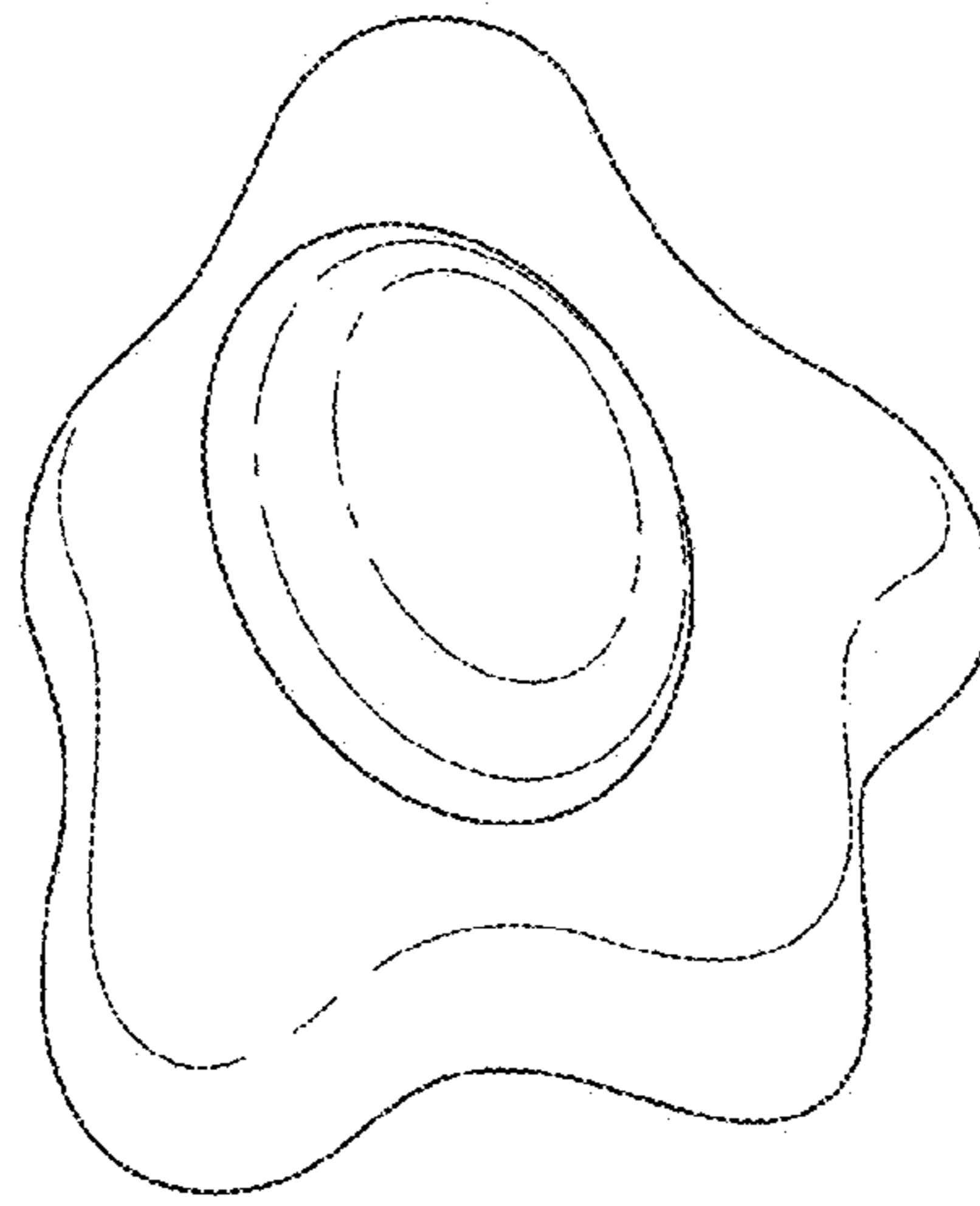

FIG. 15

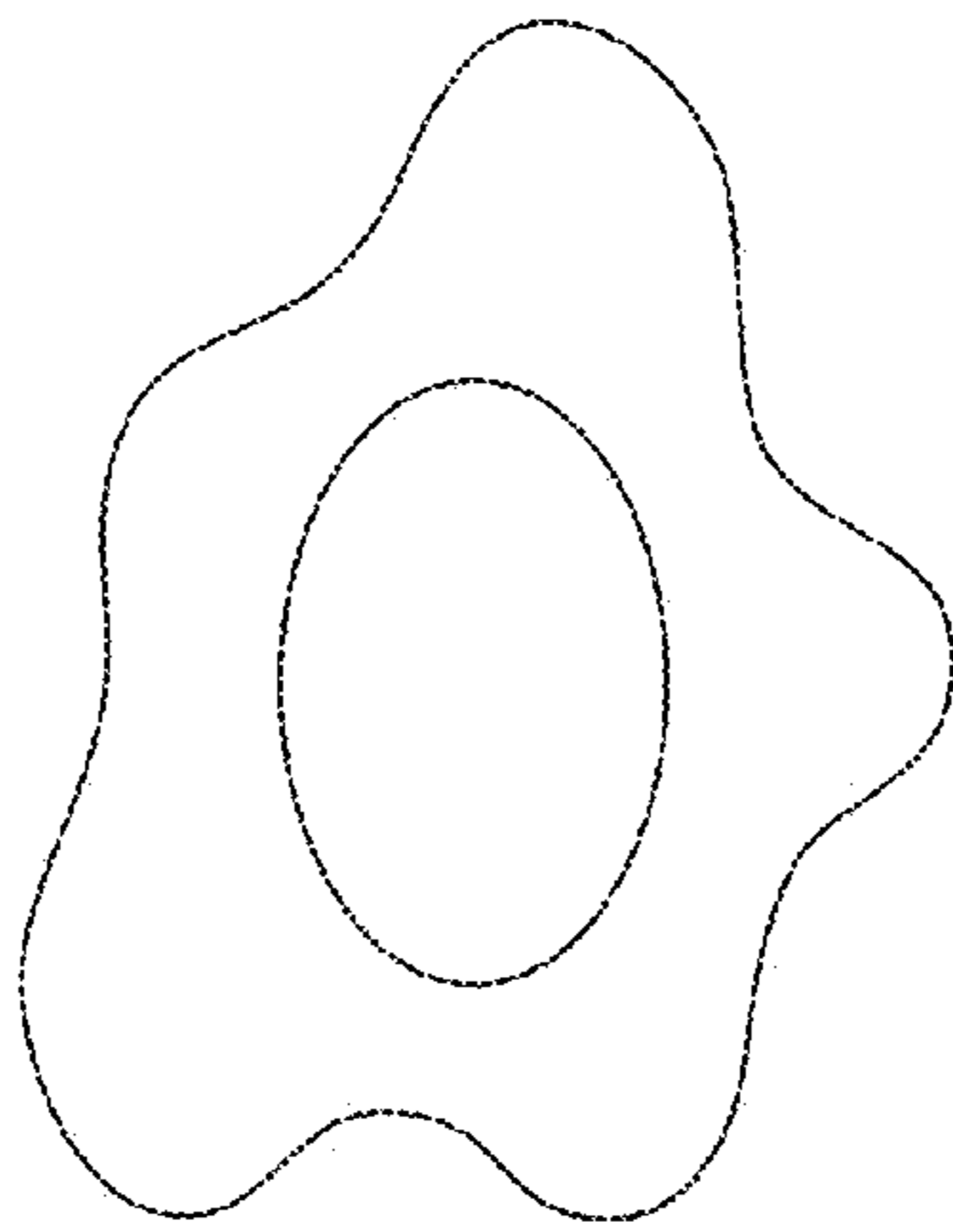

FIG. 16

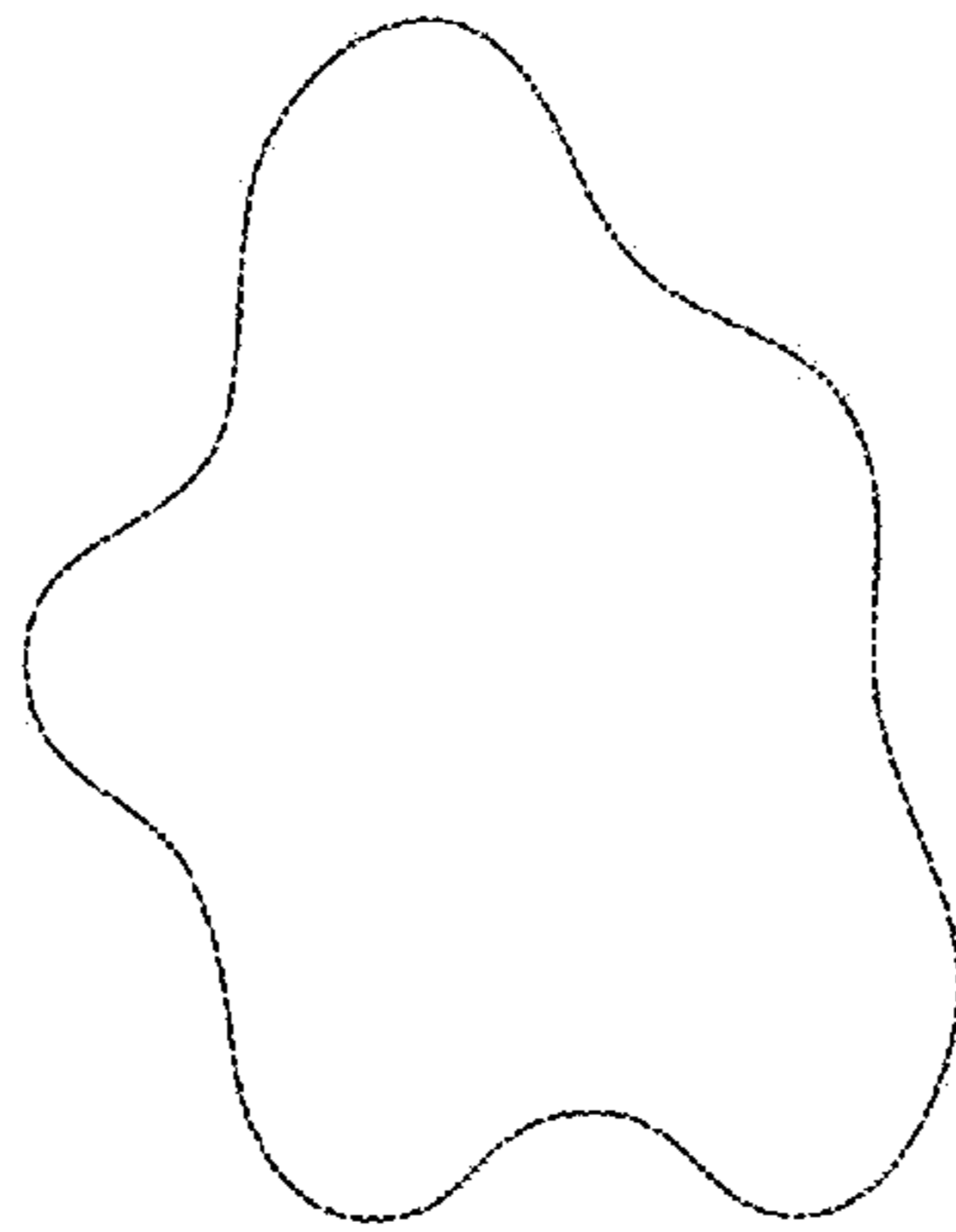

FIG. 17

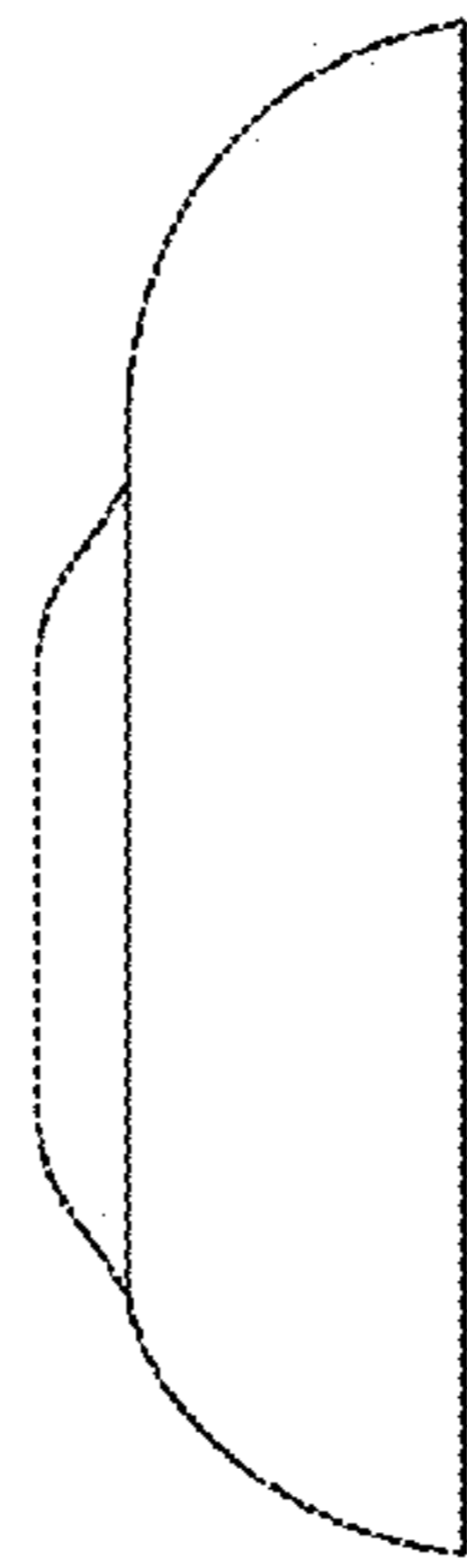

FIG. 18

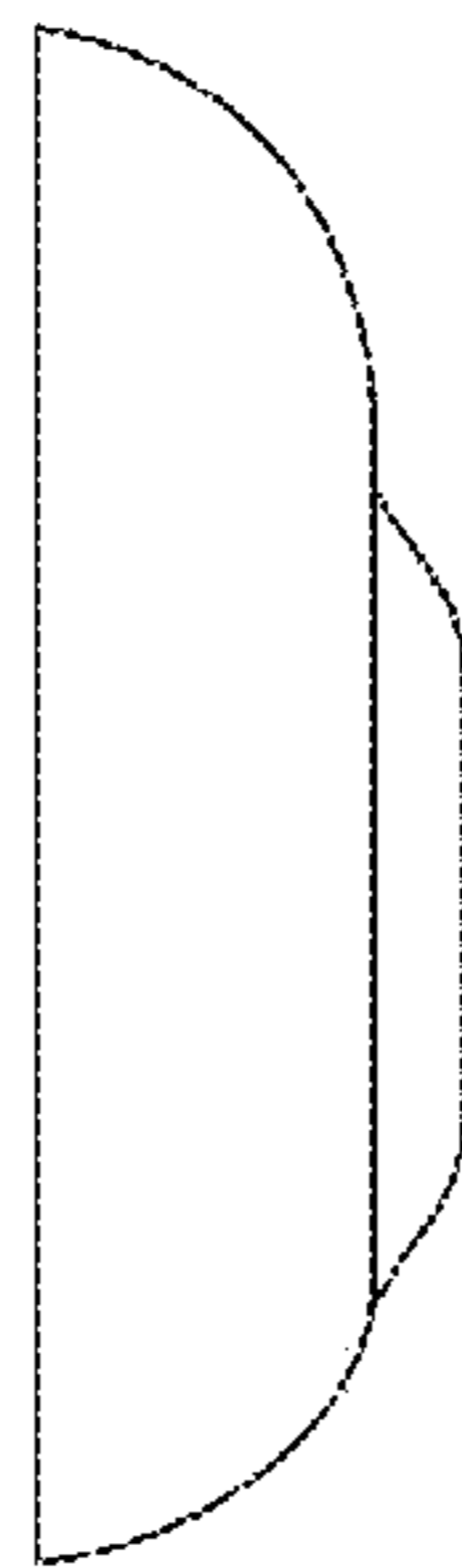

FIG. 19

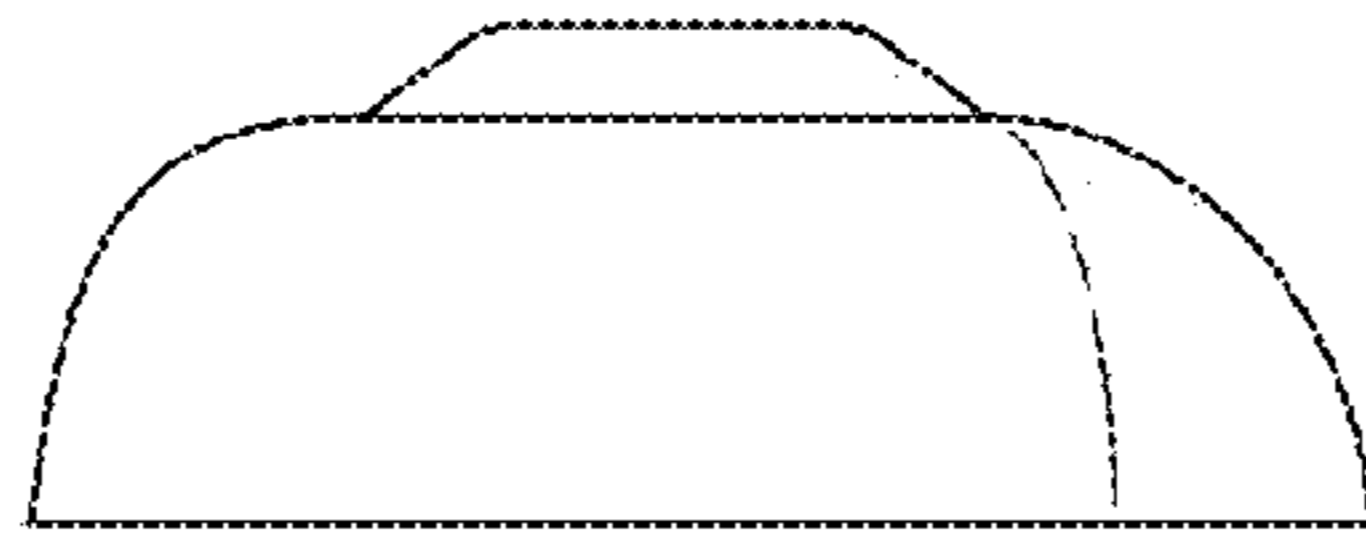

FIG. 20

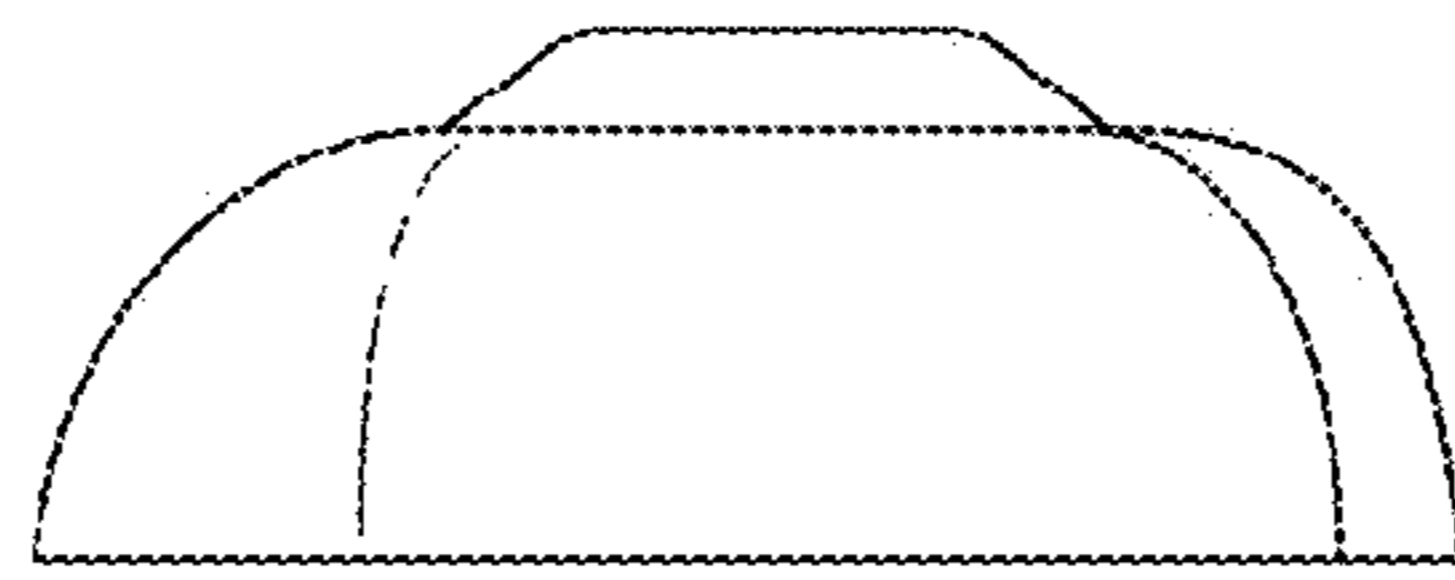

FIG. 21